

NOTES:

1. MATERIALS AND FINISHES
 BODY - BRASS, NICKEL PLATING
 CONTACT - PHOSPHOR BRONZE, GOLD PLATING
 INSULATOR - PTFE,NATURAL
2. ELECTRICAL:
 A. IMPEDANCE: 50 OHM
 B. FREQUENCY RANGE: DC 0-4 GHz
 C. DIELECTRIC WITHSTANDING VOLTAGE: 1500 VRMS, MIN.
3. MECHANICAL:
 A. DURABILITY: 500 CYCLES MIN.
 B. TEMPERATURE RANGE: - 65°C to +165°C
4. CRIMPED FERRULE
 HEX CRIMP SIZE .213"
5. CRIMPED CONTACT PIN
 HEX CRIMP SIZE .068"

THIRD ANGLE PRD.

REVISIONS

REV	DESCRIPTION	DATE	ECO	APPR
B	REDRAWN TO UPDATE FORMAT	28-Jul-08	4718D	SHE

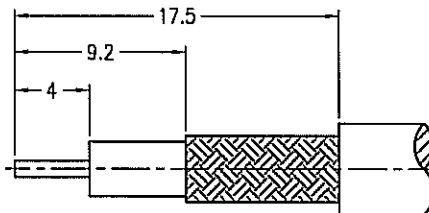

RECOMMENDED
CABLE STRIPPING DIM'S

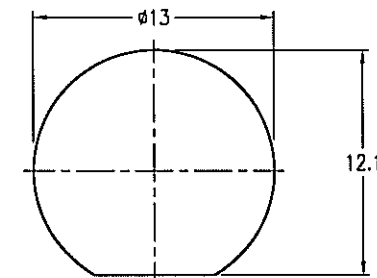

RECOMMENDED
MOUNTING HOLE

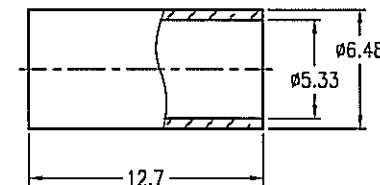
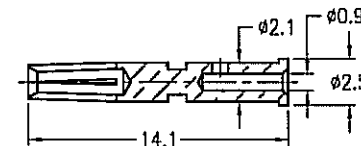
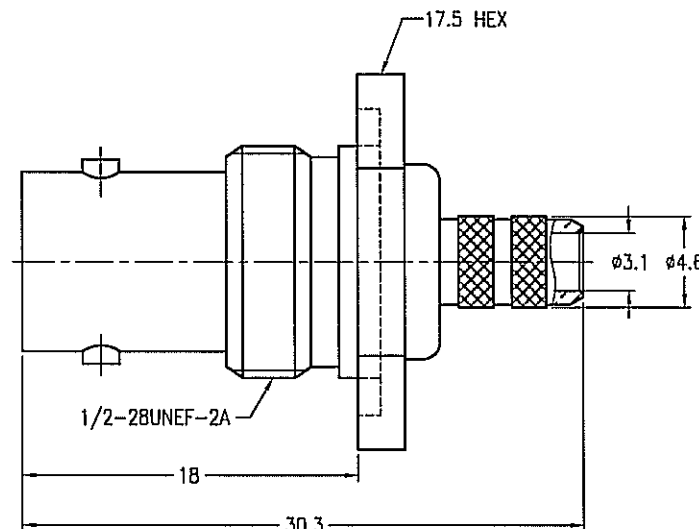
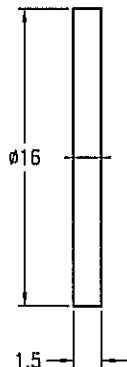
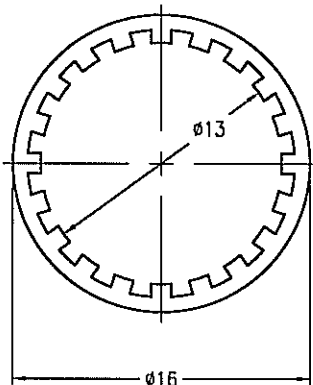
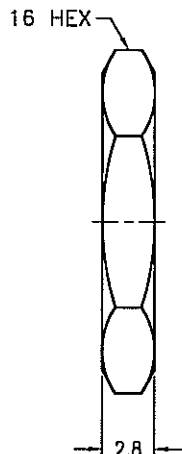

CUSTOMER OUTLINE DRAWING

ALL OTHER SHEETS ARE FOR INTERNAL USE ONLY

UNLESS OTHERWISE SPECIFIED, DIMENSIONS ARE IN METRIC AND TOLERANCES ARE:
 0.5 - 6mm ±0.1mm 6 - 30mm ±0.2mm 30 - 120mm ± 0.3mm ANGLES ±1°

NOTICE - These drawings, specifications, or other data (1) are, and remain the property of Amphenol Corp. (2) must be returned upon request; and (3) are confidential and not to be disclosed to any person other than those to whom they are given by Amphenol Corp. The furnishing of these drawings, specifications, or other data by Amphenol Corp., or to any other person to anyone for any purpose is not to be regarded by implication or otherwise in any manner licensing, granting rights or permitting such holder or any other person to manufacture, use or sell any product, process or design, patented or otherwise, that may in any way be related to or disclosed by said drawings, specifications, or other data.

MATERIAL	DRAWN BETTY.L	DATE 31-May-00	TITLE BNC BULKHEAD CRIMP JACK		Amphenol RF Danbury CT USA, Tainan Taiwan, Shenzhen China www.amphenolrf.com	
REFERENCE	ENGINEER MARK.C	DATE 31-May-00	APPROVED MARK.C		DRAWING NO. B6421A1-NT3G-58U-50	
FINISH	CAD FILE F:\DWG\B\6421A1\58U-50\NT3G-BSZ	DATE 31-May-00	SCALE:2.5/1	SHEET 2 OF 2	ITEM NO. 016421AAK58NA5F	
			DWG SIZE B	CODE ID 74868	REV B	PART NO. 031-5935-RFX