

Clip, 5 x 20 / 6.3 x 32 mm, UR



Clip 5 x 20 / 6.3 x 32 mm
 straight
 Solder

Clip 5 x 20 / 6.3 x 32 mm
 ribbed
 Solder
 Variant 2

600 VAC/DC · 16A (UL/CSA)

See below:
[Approvals and Compliances](#)

Description

- Clip-material: bronze or brass
- Fuse block accepts 5x20 or 6.3x32 fuse-links

Weblinks

[pdf data sheet](#), [html datasheet](#), [General Product Information](#), [Distributor-Stock-Check](#), [Detailed request for product](#), [Microsite](#)

Technical Data

| | |
|------------------------------|-------------------------------|
| Fuse-Link | 5 x 20 / 6.3 x 32 mm |
| Mounting | PCB |
| Terminal | Solder THT |
| Rated Voltage | 600 VAC/DC |
| Rated current | 16 A (UL/CSA) |
| Admissible Ambient Air Temp. | -40 °C to 85 °C |
| Climatic Category | 40/085/21 acc. to IEC 60068-1 |
| Material: Terminals | see variants |
| Unit Weight | 0.98 g |
| Storage Conditions | 0 °C to 60 °C, max. 70% r.h. |
| Product Marking | Certification marks |

| | |
|------------------------------|--|
| Soldering Methods | Wave Soldering Profile |
| Solderability | 245 °C / 3 sec acc. to IEC 60068-2-20, Test Ta, method 1 |
| Resistance to Soldering Heat | 260 °C / 10 sec acc. to IEC 60068-2-20, Test Tb, method 1A |
| Solderability | 245 °C / 3 sec acc. to IEC 60068-2-20, Test Ta, method 1 |
| Contact Resistance | < 10 mΩ at 100 mA |

Approvals and Compliances

Detailed information on product approvals, code requirements, usage instructions and detailed test conditions can be looked up in [Details about Approvals](#)

SCHURTER products are designed for use in industrial environments. They have approvals from independent testing bodies according to national and international standards. Products with specific characteristics and requirements such as required in the automotive sector according to IATF 16949, medical technology according to ISO 13485 or in the aerospace industry can be offered exclusively with customer-specific, individual agreements by SCHURTER.

Approvals

The approval mark is used by the testing authorities to certify compliance with the safety requirements placed on electronic products. Approval Reference Type: OG (Clip) 5x20 / 6.3x32

| Approval Logo | Certificates | Certification Body | Description |
|---------------|------------------------------|--------------------|------------------------|
| | UL Approvals | UL | UL File Number: E39328 |

Product standards

Product standards that are referenced

| Organization | Design | Standard | Description |
|--------------|-----------------------|----------------------|------------------------------|
| | Designed according to | UL 4248-1 | Industrial Control Equipment |
| | Designed according to | CSA C22.2 no. 4248.1 | Industrial Control Equipment |





Application standards

Application standards where the product can be used

| Organization | Design | Standard | Description |
|--------------|--------------------------------|----------------|---|
| | Designed for applications acc. | IEC/UL 62368-1 | Audio/video, information and communication technology equipment - Part 1: Safety requirements |

Compliances

The product complies with following Guide Lines

| Identification | Details | Initiator | Description |
|--|--|-------------|---|
|  | CE declaration of conformity | SCHURTER AG | The CE marking declares that the product complies with the applicable requirements laid down in the harmonisation of Community legislation on its affixing in accordance with EU Regulation 765/2008. |
|  | UKCA declaration of conformity | SCHURTER AG | The UKCA marking declares that the product complies with the applicable requirements laid down in the British Amendment of Regulation (EC) 765/2008. |
|  | RoHS | SCHURTER AG | Directive RoHS 2011/65/EU, Amendment (EU) 2015/863 |
|  | China RoHS | SCHURTER AG | The law SJ / T 11363-2006 (China RoHS) has been in force since 1 March 2007. It is similar to the EU directive RoHS. |
|  | REACH | SCHURTER AG | On 1 June 2007, Regulation (EC) No 1907/2006 on the Registration, Evaluation, Authorization and Restriction of Chemicals 1 (abbreviated as "REACH") entered into force. |

Dimension [mm]

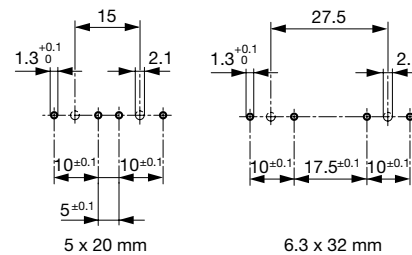
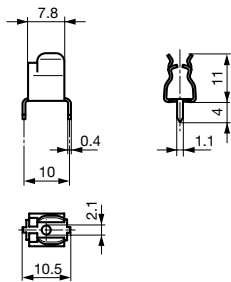

Variant 0751.0056

Drilling holes variant 0751.0056

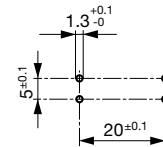
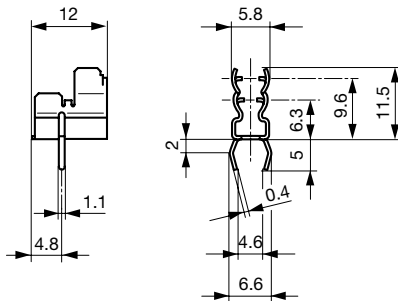

Variant 2 0751.0099, 0751.0100, 0751.0141 and 0751.0142

Drilling diagram variant 2 0751.0099, 0751.0100, 0751.0141 and 0751.0142

All Variants

| Clip | Terminal | Material: Terminals | Order Number |
|------|----------|---------------------|--------------|
| ● | straight | Tin-Plated Bronze | 0751.0056 |
| ● | kinked | Tin-Plated Bronze | 0751.0099 |
| ● | kinked | Tin-Plated Brass | 0751.0100 |
| ● | straight | Tin-Plated Bronze | 0751.0141 |
| ● | straight | Tin-Plated Brass | 0751.0142 |

Most Popular:

Availability for all products can be searched real-time: <https://www.schurter.com/en/Stock-Check/Stock-Check-SCHURTER>

Packaging Unit

Bulk (1000 pcs.)