

Radial Leaded PTC

OZRF Series

HF  OZRF Series

RoHS 2 Compliant

Product Features

- Telecom Power Cross Protection
- AEC-Q Compliant
- Meets Bel automotive qualification*
 - * - Largely based on internal AEC-Q test plan

Operating (Hold Current) Range

0.08A - 0.18A

Maximum Operating Voltage

60VDC / 100VDC

Maximum Interrupt Voltage

250VDC

Temperature Range



-40°C to 85°C

Agency Approval

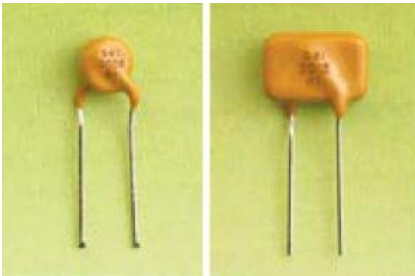
TUV (Std. EN60738-1-1, Cert. R50102125 & R50348601)
 UL Recognized Component (Std. UL1434, File E305051)



AEC-Q Compliant

LEAD FREE = 
 HALOGEN FREE = 

Electrical Characteristics (23°C)

	Part Number (Bulk)	Hold Current	Trip Current	Max. Oper. Voltage	Max Current	Typical Power	Max Time to Trip		Resistance Tolerance		Agency Approvals	
		I _H , A	I _T , A	V _{max} , Vdc	I _{max} , A	P _d , W	Current	Time	R _{min}	R _{1max}		
A	0ZRF0008FF1E	0.08	0.24	60	3	1.0	0.35	4.0	14.0	33	Y	Y
B	0ZRF0011FF1E	0.11	0.40	60	3	1.0	1.00	2.0	5.0	16	Y	Y
C	0ZRF0012FF1E	0.12	0.48	60	3	1.0	1.00	2.0	4.0	16	Y	Y
D	0ZRF0015FF1E	0.15	0.58	60	3	1.0	1.00	2.5	3.0	12	Y	Y
E	0ZRF0018FF1A	0.18	0.58	60	3	1.5	1.50	11.0	0.8	4	Y	Y
F	0ZRF0018AF1E	0.18	0.65	100	10.0	1.0	3.00	2.0	0.8	4	Y	Y

- I_H Hold Current- The maximum current at which the device will not trip in still air at 23°C.
- I_T Trip current- The minimum current at which the device will trip in still air at 23°C.
- V_{max} Maximum voltage device can withstand at its rated current without suffering damage.
- I_{max} Maximum fault current device can withstand at rated voltage (V_{max}) without damage.
- P_d Typical power dissipated by device when in tripped state in 23°C still air environment.
- R_{min} Minimum device resistance at 23°C in initial un-soldered state.
- R_{1max} Maximum device resistance at 23°C, 1 hour after initial device trip, or after being soldered to PCB in end application.

NOTE : All OZRF products are designed to assist equipment to pass ITU, UL1950 or GR1089 specification.
CAUTION : OZRF devices are not intended for continuous use of Line Voltage such as 120VAC ~ 600VAC and above.

PTC's – Basic Theory of Operation / “Tripped” Resistance Explanation

A Bel PTC consists of a block of polymeric material containing conductive carbon granules which is sandwiched between two conductive metal plates. When this polymer block reaches approximately 125C, either due to current passing through it via conductive chains of carbon particles or due to an external heat source; it swells volumetrically. This expansion breaks apart a majority of the chains of carbon granules that run randomly between the two conductive plates. This behavior results in a sharp increase in resistance across the two plates which all but eliminates current flow through the device, allowing just enough residual current flow to maintain the block's internal temperature at 125C. Once this “tripped” state current is cut off, the polymer brick cools and shrinks to its original size, thereby allowing its broken carbon chains to reestablish themselves and permit the part to return to its low resistance state. Once cooled to room ambient, the PTC will once again exhibit a resistance less than its “R1max” rating.

At currents below the device I_{HOLD} rating, AND at temperatures below 100C, the PTC maintains a resistance value below its R1 MAX rating.

The catalog data for each device specifies a "Typical Power" value. This is the power required to exactly match the heat lost by the tripped device to its ambient surroundings at 23C. By Ohm's Law, power can be stated as: $W = E^2/R$. Thus the approximate resistance of a “Tripped” PTC can be determined by: $R = E^2/W$, where "E" is the voltage appearing across the PTC (usually the supply's open circuit voltage), and "W" is the Typical Power value for the particular PTC.

Since the PPTC acts to maintain a constant internal temperature, its apparent resistance will change based upon applied voltage and, to a lesser degree, ambient conditions. Consider the following example....

A PTC with a Typical Power of 1 watt protecting a circuit using a 60V supply will demonstrate an apparent, tripped resistance "R" of:

$$R = 60^2/1 = 3,600 \text{ ohms}$$

This same tripped device when used to protect a 12V circuit would now present an apparent resistance of:

$$R = 12^2/1 = 144 \text{ ohms}$$

The value for Typical Power is "typical" because any physical factors that affect heat loss (such as ambient temperature or air convection) will somewhat alter the level of power that the PTC needs to maintain its internal temperature. In short, PTCs do not exhibit a constant, quantifiable tripped resistance value.

Average Time Current Characteristic Curve at 23°C

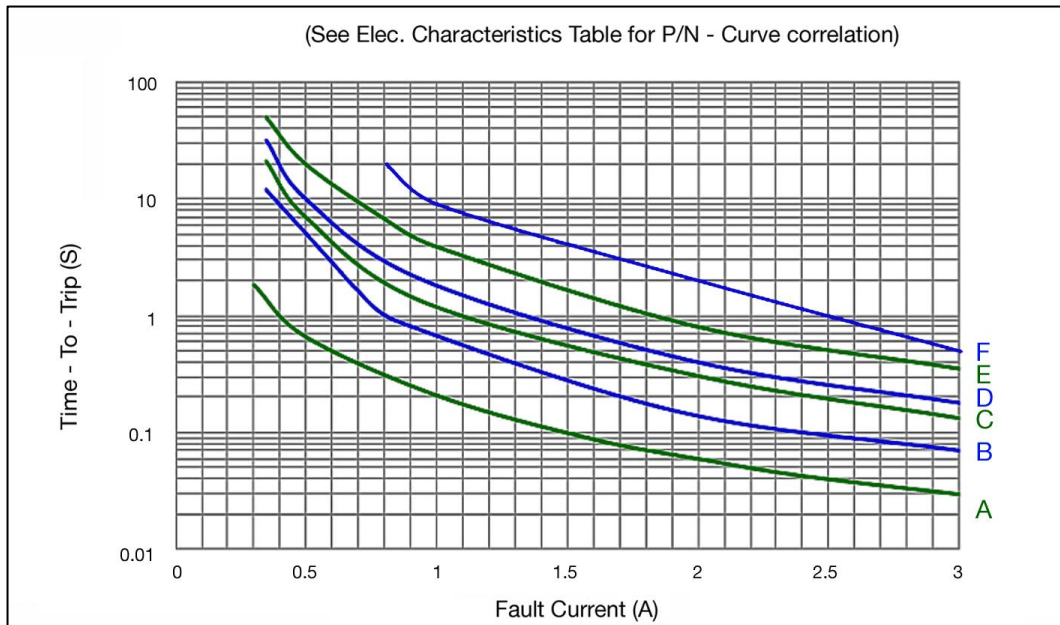

The Average Time Current Characteristic Curve and Temperature Rerating Curve are affected by a number of variables and these curves are provided for guidance only.



Specifications subject to change without notice

Bel Fuse Inc.
206 Van Vorst Street
Jersey City, NJ 07302 USA

+1 201.432.0463
Bel.US.CS@belf.com
belfuse.com/circuit-protection

Physical Specifications

Lead material:

Matte tin plated copper, size / diameter as shown in Drawings and Table under Product Dimensions.

Soldering characteristics

MIL-STD-202, Method 208H.

Insulating coating

Flame retardant epoxy, meets UL-94-V-0 requirements.

PTC Marking

“bel” or “b”, , IH code and “RF” .

Product Dimensions

All dimensions in mm.

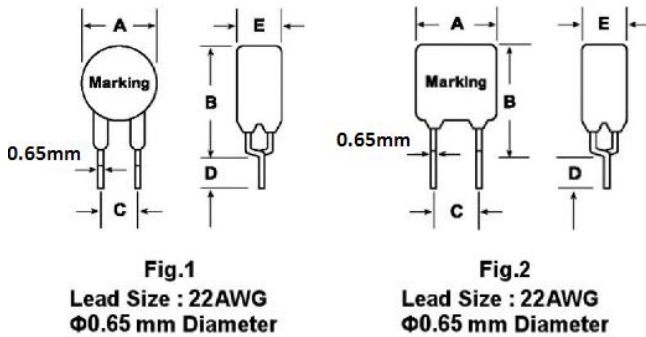

Part Number	Fig.	A	B	C	D	E
		Max	Max	Typical	Min	Max
0ZRF0008FF	1	5.8	9.6	5	4.7	4.6
0ZRF0011FF	1	6.8	9.9	5	4.7	4.6
0ZRF0012FF	2	6.5	11.0	5	4.7	4.6
0ZRF0015FF	2	6.5	11.0	5	4.7	4.6
0ZRF0018FF	2	10.9	12.6	5	4.7	4.6
0ZRF0018AF	1	9.0	12.0	5	4.7	3.8

Temperature Derating Table

I Hold Value	Temperature Derating									
	-40	-20	0	23	30	40	50	60	70	85
0ZRF	162%	143%	123%	100%	92%	79%	68%	56%	44%	26%

Thermal Derating Curve

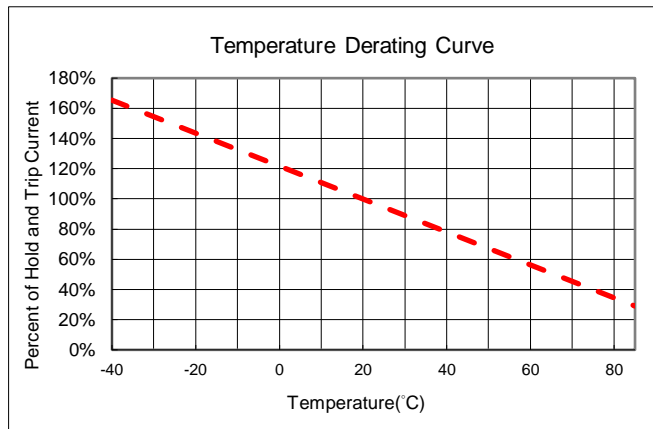

Cautionary Notes

1. Operation beyond the specified maximum ratings or improper use may result in damage and possible electrical arcing and/or flame.
2. These Polymer PTC (PPTC) devices are intended for protection against occasional overcurrent/overtemperature fault conditions and may not be suitable for use in applications where repeated and/or prolonged fault conditions are anticipated.
3. Avoid contact of PTC device with chemical solvent. Prolonged contact may adversely impact the PTC performance.
4. These PTC devices may not be suitable for use in circuits with a large inductance, as the PTC trip can generate circuit voltage spikes above the PTC rated voltage.
5. These devices may be used in both DC and AC circuits provided that peak-to-peak line voltage when carrying AC does not exceed the PTC's Vmax rating. As PTCs are essentially thermal devices, the RMS value of AC current carried by a PTC will produce tripping parameters and times-to-trip similar to those of a DC voltage of the same magnitude.
6. If potting is mandated, avoid rigid potting compounds as they will encase the PTC and prevent it from volumetrically expanding to properly respond to a trip event.