

Quick Reference Guide

INDUSTRIAL RELAYS

RELAYS, CONTACTORS & CIRCUIT BREAKERS

TE Connectivity (TE) has extensive capabilities in the design and manufacture of relays and a broad portfolio of switching solutions for demanding, high performance applications. These relay products are remotely actuated to control electrical power flow by either interrupting or completing an electrical circuit.

Complying with standardized PCB footprints, TE offers a wide range of inrush current capabilities and addresses the complete spectrum of requirements for production lines, robotics, elevators, control panels, CNC machines, motion control systems, lighting, building systems, solar, HVAC, and an array of safety-critical applications. Through agency approved test labs, we ensure that our relays are tested to meet the expectations of the industry. Whether you are designing for harsh or indoor applications, TE delivers high quality relays from state-of-the-art production lines.



CONTENTS

RELAYS, CONTACTORS & CIRCUIT BREAKERS

Power PCB Relays up to 16A	4
Power PCB Relays up to 50A+	11
Force Guided Relays	14
Panel Plug-In Relays	16
Signal Relays	22
High Frequency Relays	27
Solid State Relays	28
Circuit Breakers	33
Transformers	36

MOTION CONTROL



WHAT'S INSIDE

Power PCB Relays up to 16A

Relays, Contactors & Circuit Breakers

Key Features

SCHRACK PE

Low height 10.0mm
Sensitive 200mW coil
Mono-or bistable coil
WG type available (IEC 60335-1)

SCHRACK RE/REL

Miniature PCB relays
PCB area 200mm²
Wash tight

PCJ

Slim outline
Sensitive coil 200mW
WG type available (IEC 60335-1)
Ambient temperature up to 105°C

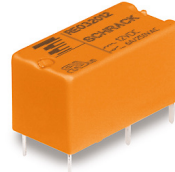

Footprint

2) see footnote below

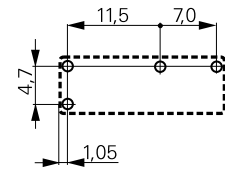
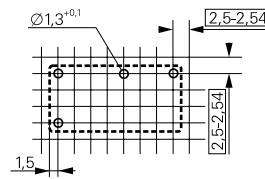
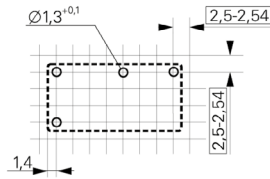

Applications

Industrial electronics
White goods
Measurement and control

PLC; Timers; I/O cards
Temperature control
White goods

Home applications
HVAC

Contact Data

Contact arrangement	1 form C (CO)	1 form A (NO)	1 form A (NO)
Rated voltage	250VAC	250VAC	250VAC
Rated current	5A (CO) 6A (NO)	6/5A	3A/5A (WG type)
Switching power / Max. break	1250VA	1500/1250VA	750VA/1250VA (WG type)
Contact material	AgNi 90/10, AgSnO ₂	AgNi 0.15, AgNi 90/10	AgNi
Min. recommended contact load	1) see footnote below	1) see footnote below	100mA at 5VDC

Coil Data

Magnetic system	DC, bistable	DC	DC
Rated coil voltage	3 to 48VDC	5 to 48VDC	5 to 24VDC
Rated coil power	200mW	200/360mW	200mW

Dielectric Strength

Initial dielectric strength	between open contacts	1000Vrms	1000Vrms	750Vrms
	between contact and coil	4000Vrms	4000/3000Vrms	4000Vrms
	between adjacent contacts			
Clearance/creepage	between contact and coil	3.2/4mm	4/4mm	8/>8mm

Other Data

Ambient temperature (max.)	+ 85°C	+70°C (RE)/ + 85°C (REL)	+ 85/ +105°C (WG type)
Category of environmental protection IEC61810	RTII, RTIII	RTIII(RE), RTII(REL)	RTII, RTIII
Terminal type	THT	THT	THT
Mounting	PCB	PCB	PCB
Dimensions	20x10x10mm	20x10x10.6mm/20.7x10.7x12mm	20.4x7x15mm

Accessories

Link to datasheet	SCHRACK PE	SCHRACK RE SCHRACK REL	PCJ
-------------------	----------------------------	---	---------------------

1) Recommended minimum load indication for contact material: AU and gold plated: 1mA at 6VDC; AgNi0.15 and AgNi90/10: 10mA at 12VDC; AgCdO and AgSnO₂: 100mA at 12VDC. Please contact technical support for detailed technical data. 2) Footprint images are representative. For a complete selection, refer to the TE data sheet via the link above.

Power PCB Relays up to 16A

Relays, Contactors & Circuit Breakers

Key Features

PCH

Compact size
WG type available (IEC 60335-1)
TV-3 ratings for NO contact

OJ/OJE/T77

Miniature size
Sensitive coil 200mW
4kV coil-contacts (OJ/OJT)
Meet UL TV-5 ratings (OJT)

PCN/PCNH

1 pole 3A/5A
Only 5mm wide
Allows high function/packaging density
RoHS compliant
(Directive 2002/95/EC)



Footprint

2) see footnote below

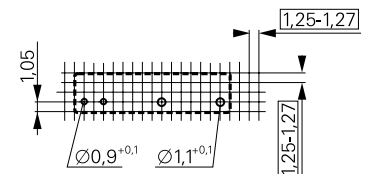
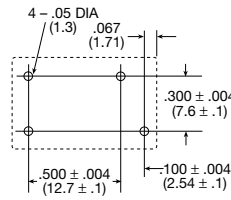
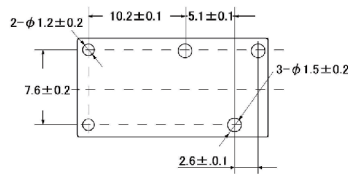

Applications	Appliances HVAC Refrigerators, microwave ovens	Appliances HVAC Industrial control	PLC Temperature control I/O modules
Contact Data			
Contact arrangement	1 form C (CO), 1 form A (NO)	1 form A (NO)	1 form A (NO)
Rated voltage	277VAC/30VDC	250VAC/28VDC	250VAC
Rated current	3/5/10A	3/5/8/10A	3A/5A
Switching power / Max. break	1400VA/150W (NO) 850VA/90W (NC)	720 to 2500VA/ 90 to 240W	750VA /1250VA
Contact material	AgSnO ₂	Ag, AgCdO, AgSnO ₂	AgNi gold plated
Min. recommended contact load	100mA at 5VDC	1) see footnote below	100mA at 5VDC
Coil Data			
Magnetic system	DC, sensitive	DC, sensitive	DC
Rated coil voltage	3 to 48VDC	3 to 48VDC	3 to 24VDC
Rated coil power	200/400mW	200/250/450mW	100mW/120mW
Dielectric Strength			
Initial dielectric strength			
between open contacts	750Vrms	750/1000Vrms	750Vrms
between contact and coil	4000Vrms	3000/4000Vrms	3000Vrms
between adjacent contacts			
Clearance/creepage			
between contact and coil	1.6/3.2mm	1.6/3.2mm and 3.2/6.4mm	3.5mm
Other Data			
Ambient temperature (max.)	+70°C (standard)/+85°C (WG type)	up to 85°C	+85°C
Category of environmental protection IEC61810	RTII, RTIII	RTII, RTIII	RTIII
Terminal type	THT	THT	THT
Mounting	PCB	PCB	PCB
Dimensions (lwh)	20x10x15.2mm	18.2x10.2x14.7mm	20x5x12.5mm
Accessories			
Link to datasheet	PCH	OJ/OJE T77	PCN

1) Recommended minimum load indication for contact material: AU and gold plated: 1mA at 6VDC; AgNi015 and AgNi90/10: 10mA at 12VDC; AgCdO and AgSnO₂: 100mA at 12VDC. Please contact technical support for detailed technical data. 2) Footprint images are representative. For a complete selection, refer to the TE data sheet via the link above.

Key Features

SCHRACK SNR

5mm wide slim outline
Strong coil pins for DIN-rail socket
Allows high function/
packaging density

SCHRACK RYII

Reflow solderable version
Low height 12.3mm
Reinforced insulation
Pinnings 3.2mm and 5mm

SCHRACK MSR/T75

High inrush currents with AgSnO contacts
4kV/8mm coil-contact
Reinforced insulation

Footprint

2) see footnote below

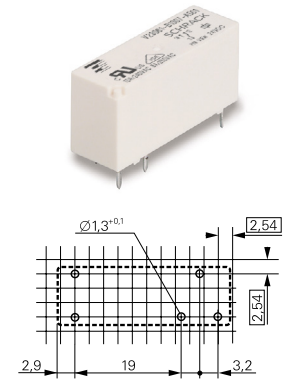
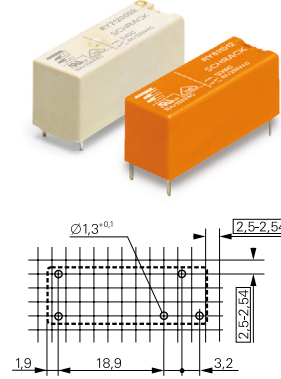
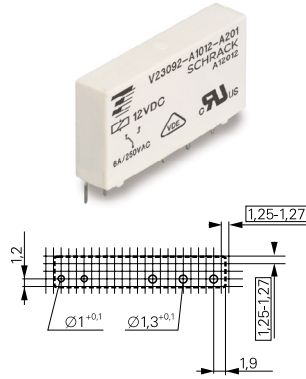

Applications	Interface technology PLC, timers, Heating control	Interface technology HVAC, PLC, Power supplies Domestic appliances	Interface technology HVAC, PLC, Power supplies Domestic appliances
Contact Data			
Contact arrangement	1 form C (CO), 1 form A (NO)	1 form C (CO), 1 form A (NO), 1 form B (NC)	1 form C (CO) 1 form A (NO)
Rated voltage	250VAC	250VAC	250VAC
Rated current	6A	8A	8/10A
Switching power / Max. break	1500VA	2000VA	2000VA
Contact material	AgSnO ₂ , AgSnO ₂ gold plated	AgNi0.15, AgSnO ₂ , AgNi 0.15 gold plated	AgNi90/10, AgSnO ₂
Min. recommended contact load	100mA at 12VDC	1) see footnote below	1) see footnote below
Coil Data			
Magnetic system	DC	DC	DC
Rated coil voltage	5 to 48VDC	5 to 60VDC	3 to 60VDC
Rated coil power	170/217mW	(223 - 257)mW	(212-262)mW
Dielectric Strength			
Initial dielectric strength			
between open contacts	1000Vrms	1000Vrms	1000Vrms
between contact and coil	4000Vrms	5000Vrms	4000Vrms
between adjacent contacts			
Clearance/creepage			
between contact and coil	6/8mm	8/8mm	8/8mm
Other Data			
Ambient temperature (max.)	+85°C	+70°C	+85°C
Category of environmental protection IEC61810	RTIII	RTII, RTIII	RTII, RTIII
Terminal type	THT	THT, THR	THT
Mounting	PCB or on socket	PCB or on socket	PCB
Dimensions (lwh)	28x5x15mm	28.5x10.1x12.3mm	28.6x10x15mm
Accessories	DIN rail sockets	PCB sockets	
Link to datasheet	SCHRACK SNR	SCHRACK RYII	SCHRACK MSR

1) Recommended minimum load indication for contact material: AU and gold plated: 1mA at 6VDC; AgNi0.15 and AgNi90/10: 10mA at 12VDC; AgCdO and AgSnO₂: 100mA at 12VDC. Please contact technical support for detailed technical data. 2) Footprint images are representative. For a complete selection, refer to the TE data sheet via the link above.

Power PCB Relays up to 16A

Relays, Contactors & Circuit Breakers

Key Features

SCHRACK RZ

High performance version available
Reinforced insulation
High ambient temperature version (105°C)
WG type available (IEC 60335-1)
AgNi and AgSnO contact versions
THR (reflow) version

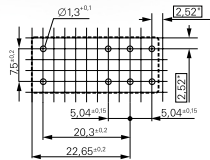

SCHRACK RT

DC and AC coil
Mono- or bistable coil
Reinforced insulation
WG type available (IEC 60335-1)
High ambient temperature version (105°C)
THR (reflow) version
Sensitive version
Bifurcated contacts

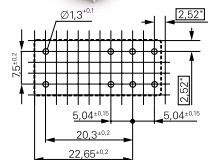

SCHRACK RT INRUSH

For inrush peak currents up to 80A
Mono- or bistable coil
Reinforced insulation
WG type available (IEC 60335-1)

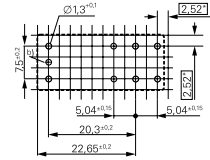

Footprint

2) see footnote below

Applications

Household appliances
HVAC, Home automation
Machine control, Energy control

HVAC, Home automation,
Machine control, Energy control
Switching cabinet, Interface modules

Lighting applications, Movement detectors, Motors control, Domestic appliances

Contact Data

Contact arrangement	1 form C (CO) 1 form A (NO)	1 form C (CO), 1 form A (NO) 2 form C (CO), 2 form A (NO)	1 form C (CO) 1 form A (NO)
Rated voltage	250VAC	250VAC	250VAC
Rated current	16A	2X8/16A	16A
Switching power / Max. break	4000VA	2X2000/4000VA	4000VA
Contact material	AgNi90/10, AgSnO ₂	AgNi90/10, AgSnO ₂	AgNi90/10, AgSnO ₂
Min. recommended contact load	1) see footnote below	1) see footnote below	1) see footnote below

Coil Data

Magnetic system	DC	DC, AC, bistable	DC, bistable
Rated coil voltage	5 to 48VDC	5 to 110VDC/24 to 230VAC	5 to 11VDC
Rated coil power	400mW	400mW/0.75VA	400mW

Dielectric Strength

Initial dielectric strength			
between open contacts	1000Vrms	1000Vrms	1000Vrms
between contact and coil	5000Vrms	5000Vrms	5000Vrms
between adjacent contacts		2500Vrms	
Clearance/creepage			
between contact and coil	>10/10mm	>10/10mm	>10/10mm

Other Data

Ambient temperature (max.)	+85°C +105°C (HOT type) +70°C (transparent cover type)	+75°C (AC type) +85°C	+85°C
Category of environmental protection IEC61810	RTII, RTIII	RTII, RTIII	RTII
Terminal type	THT	THT, THR (DC and AC type)	THT
Mounting	PCB	PCB or on socket	PCB or socket
Dimensions (lwh)	29x12.7x15.7mm	29x12.7x15.7mm	29x12.7x15.7mm

Accessories

PCB and DIN rail sockets

Link to datasheet

[SCHRACK RZ](#)

[SCHRACK RT](#)

[SCHRACK RT INRUSH](#)

1) Recommended minimum load indication for contact material: AU and gold plated: 1mA at 6VDC; AgNi0.15 and AgNi90/10: 10mA at 12VDC; AgCdO and AgSnO₂: 100mA at 12VDC. Please contact technical support for detailed technical data. 2) Footprint images are representative. For a complete selection, refer to the TE data sheet via the link above.

Key Features

SCHRACK RTX

Inrush peak currents up to 370A
Bistable coil
Reinforced insulation
16A rated fluorescent load acc. EN60669-1
8A electronic ballast acc. UL508
1 1/2 HP motor load acc. UL508

SCHRACK RT IPOWER

High Inrush peak currents up to 165A (20ms) and 800A (200µs)
Mono-or bistable coil
RTS3T: 5A Electronic ballast acc. UL508
RTSET: 8A Electronic ballast acc. UL508
Test tab (manual operator) optional for RTT3T bistable versions

SCHRACK RP3SL

Inrush peak currents up to 120A (20ms)
Mono-or bistable coil
Sealed version available

Footprint

2) see footnote below

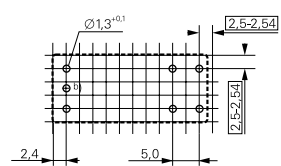
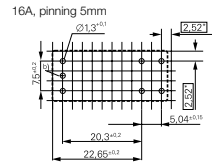
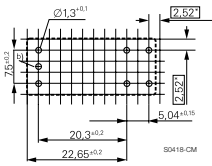

Applications

Lighting control systems
Motion sensors
Home automation applications

LED lighting systems, Lighting control, Movement detectors
Filament and incandescent lamp
Motor control

Lighting control
Motor control
Building automation

Contact Data

Contact arrangement	1 from A (NO)	1 from A (NO)	1 form A, 1 NO
Rated voltage	250VAC	250VAC	250VAC
Rated current	16A	16A	16A
Switching power / Max. break	4000VA	4000VA	4000VA
Contact material	W (pre-make contact) + AgSnO ₂	W (pre-make contact) + AgSnO ₂	AgSnO ₂
Min. recommended contact load	1) see footnote below	1) see footnote below	100mA at 12VDC

Coil Data

Magnetic system	Bistable	DC, bistable	DC
Rated coil voltage	5 to 48VDC	5 to 11VDC	6 to 110VDC
Rated coil power	650mW/665mW	400mW	500mW

Dielectric Strength

Initial dielectric strength	between open contacts	1250Vrms	1250Vrms	2000Vrms
	between contact and coil	5000Vrms	5000Vrms	4000Vrms
	between adjacent contacts			
Clearance/creepage	between contact and coil	min. 6/6mm	10/10mm	8/8mm

Other Data

Ambient temperature (max.)	+70°C	RTS3L/RTS3T +105°C, RTSET +85°C	+70°C
Category of environmental protection IEC61810	RTII	RTII	RTII, RTIII
Terminal type	THT	THT	THT
Mounting	PCB	PCB	PCB
Dimensions (lwh)	29.1x12.7x16mm	29x12.7x15.7mm (RTS3T), 29x12.7x16.0mm (RTS3L)	29x12.6x25.5mm

Accessories

Link to datasheet	SCHRACK RTX	SCHRACK RT IPOWER	SCHRACK RP3SL
-------------------	-----------------------------	-----------------------------------	-------------------------------

1) Recommended minimum load indication for contact material: AU and gold plated: 1mA at 6VDC; AgNi0.15 and AgNi90/10: 10mA at 12VDC; AgCdO and AgSnO₂: 100mA at 12VDC. Please contact technical support for detailed technical data. 2) Footprint images are representative. For a complete selection, refer to the TE data sheet via the link above.



Power PCB Relays up to 16A

Relays, Contactors & Circuit Breakers

Key Features

SCHRACK RP-2POLE 1.5MM

2 pole 8A
1.5mm contact gap per pole
Creepage distance complies with IEC 60950
Sealed version available



SCHRACK PB/PBH

Compact and simple design gives high process security
High ambient temperature version up to 105°C (PBH)
WG type acc. IEC 60335-1



SCHRACK ORWH

Compact relay with 1 form A and 1 form C contact arrangement
10A switching capacity



Footprint

2) see footnote below

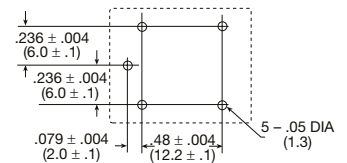
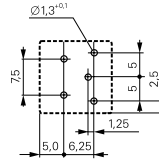
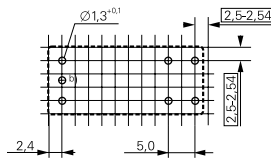

Applications	Domestic appliances UPS Solar Inverter	White goods Small home appliances Heating temperature controllers	Appliances HVAC Emergency lighting
Contact Data			
Contact arrangement	2 form A, 2 NO	1 form C (CO) 1 form A (NO)	1 form C (CO) 1 form A (NO)
Rated voltage	250VAC	250VAC	277VAC/28VDC
Rated current	8A	10A	10A
Switching power / Max. break	2000VA	2500VA	2770VA/360W
Contact material	AgSnO ₂	AgNi90/10, AgSnO	AgZnO, AgNi
Min. recommended contact load	100mA at 12VDC	1) see footnote below	100mA at 5VDC
Coil Data			
Magnetic system	DC	DC	DC
Rated coil voltage	5 to 110VDC	5 to 48VDC	5 to 24VDC
Rated coil power	780mW	360mW/500mW	360mW
Dielectric Strength			
Initial dielectric strength			
between open contacts	25000Vrms	1000Vrms	750Vrms
between contact and coil	5000Vrms	2500Vrms	1500Vrms
between adjacent contacts	300Vrms		
Clearance/creepage			
between contact and coil	7/8mm	3/4mm / 4/5mm	3.2mm
Other Data			
Ambient temperature (max.)	+40°C	+85°C/+105°C	+85°C
Category of environmental protection IEC61810	RTII, RTIII	RTII	RTII, RTIII
Terminal type	THT	THT	THT
Mounting	PCB	PCB	PCB
Dimensions (lwh)	29x12.6x25.5mm	15x15x20mm	19.0x15.5x15.8mm
Accessories			
Link to datasheet	SCHRACK RP-2POLE 1.5MM	SCHRACK PB SCHRACK PBH	SCHRACK ORWH

1) Recommended minimum load indication for contact material: AU and gold plated: 1mA at 6VDC; AgNi015 and AgNi90/10: 10mA at 12VDC; AgCdO and AgSnO₂: 100mA at 12VDC. Please contact technical support for detailed technical data. 2) Footprint images are representative. For a complete selection, refer to the TE data sheet via the link above.

Power PCB Relays up to 50A+

Relays, Contactors & Circuit Breakers

Key Features

Potter & Brumfield T9G

High breaking capacity
PCB and quick connect connections
4kV coil-contact
Minimum board space
(29mm x 21.5mm)
UL-class F as standard

Potter & Brumfield T9A

High breaking capacity
PCB and quick connect and chassis mount version
UL-class F as standard
Open version available

Potter & Brumfield T9S/T9V

1 pole 35A (T9S)/40A (T9V)
Contact gap 1.5mm/1.8mm min.
Ambient temperature up to 85°C at 35A
Production in accordance to IEC 60335-1
RoHS compliant (Directive 2002/95/EC)

Footprint

2) see footnote below

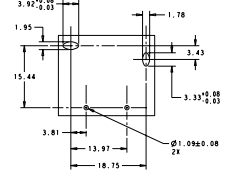
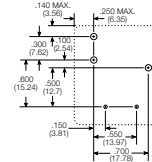
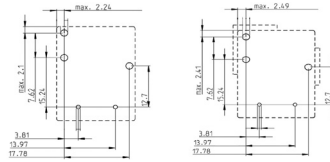
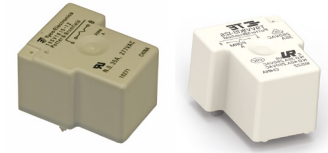
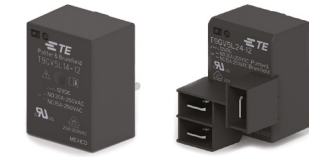

Applications	HVAC, Appliances Industrial control Energy management	HVAC Appliances Industrial controls	Photovoltaic inverter Electrical vehicle loading stations Electrical vehicle
Contact Data			
Contact arrangement	1 form C (1 CO) 1 form B (1 NC) 1 form A (1 NO)	1 form C (1 CO) 1 form B (1 NC) 1 form A (1 NO)	1 form A (1NO)
Rated voltage	250VAC	250VAC	277VAC (1.5mm gap), 250VAC (1.8mm gap)
Rated current	30A	30A	35A (T9S) , 40A (T9V)
Switching power / Max. break		7500VA	9695VA (T9S), 10000VA (T9V)
Contact material	AgSnO ₂	AgCdO, AgSnInO	AgNi
Min. recommended contact load	1A at 12VAC/VDC	1A at 5VDC or 12VAC	1A at 5VDC/12VAC
Coil Data			
Magnetic system	DC	DC	Monostable
Rated coil voltage	5 to 110VDC	6 to 48VDC	12VDC
Rated coil power	900mW	1W/900mW	2.25W
Dielectric Strength			
Initial dielectric strength			
between open contacts	1500Vrms	1500Vrms	2500Vrms
between contact and coil	4000Vrms	2500Vrms	4000Vrms
between adjacent contacts			
Clearance/creepage			
between contact and coil	>6.4mm/>8mm	3.1/6.3mm	3/4mm
Other Data			
Ambient temperature (max.)	+105°C	+85°C	+85°C
Category of environmental protection IEC61810	RTII, RTIII	RTO, RTI, RTII, RTIII	RTII/RTIII
Terminal type	THT/Quick connect	THT/Quick connect	PCB
Mounting	PCB	PCB, panel mount	PCB
Dimensions (lwh)	29x21.5x15.7mm	32.3x27.4x20.4mm	32x27x20mm
Accessories			
Link to datasheet	POTTER & BRUMFIELD T9G	POTTER & BRUMFIELD T9A	Potter & Brumfield T9V Potter & Brumfield T9S

1) Recommended minimum load indication for contact material: AU and gold plated: 1mA at 6VDC; AgNi0.15 and AgNi90/10: 10mA at 12VDC; AgCdO and AgSnO₂: 100mA at 12VDC. Please contact technical support for detailed technical data. 2) Footprint images are representative. For a complete selection, refer to the TE data sheet via the link above.



Power PCB Relays up to 50A+

Relays, Contactors & Circuit Breakers

Key Features

Potter & Brumfield T92

Switching capacity 7500VA
DC or AC coil
4kV/8mm coil-contact
PCB or quick connect connections
or chassis mount



PCF

Quick connect terminal for load (PCF only)
Height 26.5mm
Meet 4kV dielectric voltage between coil and contact
Ambient temperature 85°C



PCFN SOLAR

Specially designed to meet the requirements for solar
Contact gap 1.5mm/1.8mm min.
200mW hold power



Footprint

2) see footnote below

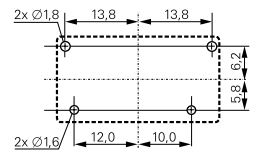
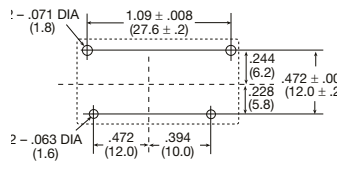
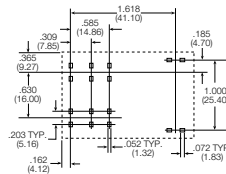

Applications	Potter & Brumfield T92	PCF	PCFN SOLAR
	HVAC Residential/commercial appliances Industrial controls	Appliances HVAC Office machines	Photovoltaic Inverter

Contact Data	Potter & Brumfield T92	PCF	PCFN SOLAR
Contact arrangement	2 form C (2 CO) 2 form A (2 NO)	1 form A (1 NO)	1 form A (1 NO)
Rated voltage	400VAC	250VAC	277VAC
Rated current	30A	25A	26A
Switching power / Max. break	7500VAC	6370VA	7200VA
Contact material	AgCdO, AgSnInO	Visit TE.com for more information	AgSnO ₂
Min. recommended contact load	500mA (NO)/ 100mA (NC) at 12VAC	100mA at 5VDC	100mA at 5VDC

Coil Data	Potter & Brumfield T92	PCF	PCFN SOLAR
Magnetic system	DC, AC	DC	DC
Rated coil voltage	5 to 110VDC/12 to 240VAC	6 to 24VDC	12VDC and 24VDC
Rated coil power	1.7W/4.0VA	900mW	1.5W/200mW hold power

Dielectric Strength	Potter & Brumfield T92	PCF	PCFN SOLAR
Initial dielectric strength			
between open contacts	1500Vrms	1000Vrms	2500Vrms
between contact and coil	4000Vrms	4000Vrms	4000Vrms
between adjacent contacts	2000Vrms		
Clearance/creepage			
between contact and coil	8/9.5mm	6.7/>8mm	6.1/6.1mm

Other Data	Potter & Brumfield T92	PCF	PCFN SOLAR
Ambient temperature (max.)	DC Coil +85°C; AC Coil +65°C	+85°C	+85°C
Category of environmental protection IEC61810	RTI, RTII, RTIII	RTII	RTII
Terminal type	THT/Quick connect	THT/Quick connect (#250)	PCB-THT
Mounting	Panel mount, PCB	PCB	PCB
Dimensions (lwh)	52.3x34.6x30.8mm	30.4x16x26.5mm	30.4x16x26.5mm

Accessories	Potter & Brumfield T92	PCF	PCFN SOLAR
Link to datasheet	POTTER & BRUMFIELD T92	PCF	PCFN SOLAR

1) Recommended minimum load indication for contact material: AU and gold plated: 1mA at 6VDC; AgNi0.15 and AgNi90/10: 10mA at 12VDC; AgCdO and AgSnO₂: 100mA at 12VDC. Please contact technical support for detailed technical data. 2) Footprint images are representative. For a complete selection, refer to the TE data sheet via the link above.

Key Features

EW60

1 pole 60A, 1 form A (NO) contact
 Polarized bistable (latching) with 1 or 2 coils
 NEMA 410-2011, 16A, 277VAC, electronic ballast; 20A branch circuit
 480A inrush, 2.1m sec



Footprint

2) see footnote below

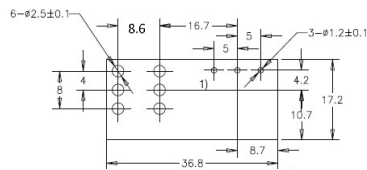

Applications

Lighting control, bus actuator,
 power distribution, circuit protection, inverter

Contact Data

Contact arrangement	1 form A (1 NO)
Rated voltage	440VAC
Rated current	60A
Switching power / Max. break	15000VA
Contact material	AgSnO ₂
Min. recommended contact load	Visit TE.com for more information

Coil Data

Magnetic system	Bistable
Rated coil voltage	5 to 24VDC
Rated coil power	1.5W/3W

Dielectric Strength

Initial dielectric strength	
between open contacts	1500Vrms
between contact and coil	4000Vrms
between adjacent contacts	
Clearance/creepage	
between contact and coil	≥6/9mm

Other Data

Ambient temperature (max.)	+70°C
Category of environmental protection IEC61810	RTI
Terminal type	PCB
Mounting	PCB
Dimensions (lwh)	36.8x17.2x30.4mm

Accessories

Link to datasheet [EW60](#)

1) Recommended minimum load indication for contact material: AU and gold plated: 1mA at 6VDC; AgNi0.15 and AgNi90/10: 10mA at 12VDC; AgCdO and AgSnO₂: 100mA at 12VDC. Please contact technical support for detailed technical data. 2) Footprint images are representative. For a complete selection, refer to the TE data sheet via the link above.

Power PCB Relays up to 50A+

Relays, Contactors & Circuit Breakers

Key Features

IHV

Hermetically sealed - intrinsically safe
Designed accordance to AIAG QS9000
No position sensitive
RoHS compliance



PCB mount not applicable.
Visit TE.com for more information

Potter & Brumfield PRD

Contact ratings to 50A
Magnetic blowout available for switching DC loads
SPDT auxiliary switch available
Class B insulation system

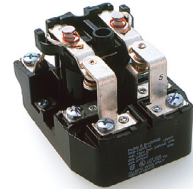

PCB mount not applicable.
Visit TE.com for more information

Applications

DC charging, Solar inverter, Energy store station
BMS, Electrical forklift, AGV, Rail transit
Circuit protection and Safety in Industrial Machinery

Industrial controls
Lighting

Contact Data

Contact arrangement	1 form X	1 form A (1 NO) 1 form C (1 CO) 1 form X (NO-DM) 2 form A (2 NO) 2 form C (2 CO)
Rated voltage	450VDC / 750VDC	600VAC, 28/125VDC
Rated current	50A/100A/150A/200A/250A/350A	50A
Switching power / Max. break		12000VA
Contact material		Ag, AgCdO
Min. recommended contact load	Visit TE.com for more information	1A at 12VDC/VAC

Coil Data

Magnetic system	DC	DC, AC
Rated coil voltage	12VDC, 24VDC or PWM	6 to 110VDC/6 to 480VAC
Rated coil power	Visit TE.com for more information	2W/9.8VA

Dielectric Strength

Initial dielectric strength		2000Vrms
between open contacts		2000Vrms
between contact and coil	2000Vrms	2000Vrms
between adjacent contacts		2000Vrms
Clearance/creepage		
between contact and coil	Visit TE.com for more information	>8mm

Other Data

Ambient temperature (max.)	+85°C	DC +80°C AC +45°C
Category of environmental protection IEC61810	RTV	RT 0/open
Terminal type	Screw	Screw/Quick connect
Mounting	Panel mount	Panel mount
Dimensions (lwh)	Visit TE.com for more information	85.7X63.8X63.5mm

Accessories

Dust cover

Link to datasheet

[POTTER & BRUMFIELD PRD](#)

1) Recommended minimum load indication for contact material: AU and gold plated: 1mA at 6VDC; AgNi0.15 and AgNi90/10: 10mA at 12VDC; AgCdO and AgSnO₂: 100mA at 12VDC. Please contact technical support for detailed technical data.

Force Guided Relays

Relays, Contactors & Circuit Breakers

Key Features

SCHRACK SR2M

2 pole relay with force guided contacts according to EN50205
Reinforced insulation between poles

SCHRACK SR4 D/M

4 pole relay with force guided contacts according to EN50205
Compact design, space efficient



Footprint

2) see footnote below

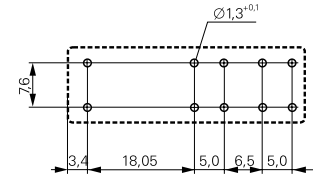
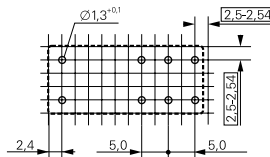

Applications

Safety modules
Process technology
Elevator and Escalator control

Safety modules
Process technology
Elevator and Escalator control

Contact Data

Contact arrangement	1 form A + 1 form B (1 NO + 1 NC) 2 form C (2 CO)	3 form A + 1 form B (3 NO + 1 NC) 2 form A + 2 form B (2 NO + 2 NC)
Rated voltage	250VAC	250VAC
Rated current	6A	8A
Switching power / Max. break	1500VA	2000VA
Contact material	AgNi	AgSnO ₂
Min. recommended contact load	10mA at 5VDC	10mA at 5VDC

Coil Data

Magnetic system	DC	DC
Rated coil voltage	5 to 110VDC	5 to 110VDC
Rated coil power	700mW	800mW

Dielectric Strength

Initial dielectric strength		
between open contacts	1500Vrms	1500Vrms
between contact and coil	4000Vrms	4000Vrms
between adjacent contacts	3000Vrms	2500Vrms
Clearance/creepage		
between contact and coil	8/8mm	10/10mm

Other Data

Ambient temperature (max.)	+70°C	+70°C
Category of environmental protection IEC61810	RTIII	RTIII
Terminal type	THT/Plug-in	THT
Mounting	PCB/Socket	PCB
Dimensions (lwh)	29x12.6x25.5mm	40x13x16.5mm

Accessories

Sockets and relay clips

Link to datasheet

[SCHRACK SR2M](#)

[SCHRACK SR4 D/M](#)

1) Recommended minimum load indication for contact material: AU and gold plated: 1mA at 6VDC; AgNi0.15 and AgNi90/10: 10mA at 12VDC; AgCdO and AgSnO₂: 100mA at 12VDC. Please contact technical support for detailed technical data. 2) Footprint images are representative. For a complete selection, refer to the TE data sheet via the link above.

Force Guided Relays

Relays, Contactors & Circuit Breakers

Key Features

SCHRACK SR6

4/6 pole relay with force guided contacts according to EN50205

Reinforced insulation between all contacts depending on version



SCHRACK SRL7

7 pole relay with force guided contacts according to EN50205



Footprint

2) see footnote below

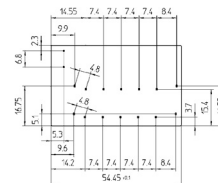
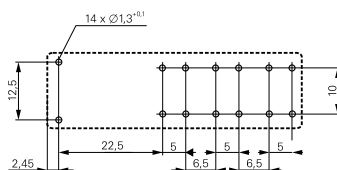

Applications

Safety modules
Process technology
Elevator and escalator control

Safety modules
Process technology
Elevator and escalator control

Contact Data

Contact arrangement	3 form A + 1 form B (3 NO + 1 NC) 2 form A + 2 form B (2 NO + 2 NC) 3 form A + 3 form B (3 NO + 3 NC) 4 form A + 2 form B (4 NO + 2 NC) 5 form A + 1 form B (5 NO + 1 NC)	2 form B + 5 form A (2 NC + 5 NO)
Rated voltage	250VAC	250VAC
Rated current	8A	6A
Switching power / Max. break	2000VA	1500VA
Contact material	AgSnO ₂	Ag alloy
Min. recommended contact load	10mA at 5VDC	10mA at 5VDC

Coil Data

Magnetic system	DC	DC
Rated coil voltage	5 to 110VDC	5 to 110VDC
Rated coil power	1200/800mW	700mW

Dielectric Strength

Initial dielectric strength between open contacts	1500Vrms	1000Vrms
between contact and coil	4000Vrms	2500/4000Vrms
between adjacent contacts	3000/4000Vrms	2500/4000Vrms
Clearance/creepage between contact and coil	5.5/5.5mm, 15/15mm	≥3/4mm and ≥5.5/5.5mm

Other Data

Ambient temperature (max.)	+70°C	+85°C
Category of environmental protection IEC61810	RTIII	RTII
Terminal type	THT	THT
Mounting	PCB	PCB
Dimensions (lwh)	55x16.5x16.5mm	55.5x33.8x10.8mm

Accessories

Link to datasheet

[SCHRACK SR6](#)

[SCHRACK SRL7](#)

1) Recommended minimum load indication for contact material: AU and gold plated: 1mA at 6VDC; AgNi0.15 and AgNi90/10: 10mA at 12VDC; AgCdO and AgSnO₂: 100mA at 12VDC. Please contact technical support for detailed technical data. 2) Footprint images are representative. For a complete selection, refer to the TE data sheet via the link above.

Panel Plug-In Relays

Relays, Contactors & Circuit Breakers

Key Features

SCHRACK SLIM INTERFACE SNR

Strong coil pins for DIN-rail socket
LED and protection circuit standard
4kV coil-contact, 6/8mm clearance/
creepage
System width only 6.2mm



SCHRACK INTERFACE RELAY RT

Strengthened pins designed to plug into DIN-rail-sockets
Cadmium-free contacts
Complete interface solutions available
Modular concept socket/relay/module

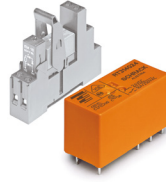

SCHRACK INTERFACE RELAY XT

Manual test tab, optionally lockable
Mechanical and electrical indicator
Reinforced insulation
4kV/8mm dielectric strength between coil and contact



Footprint

2) see footnote below

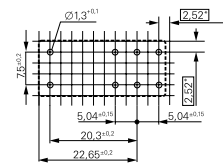
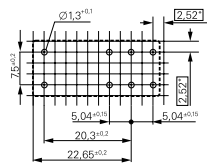
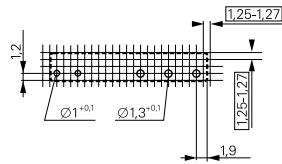

Applications	Interface technology Panel board Mechanical engineering	Panel board Mechanical engineering Machine Industry	Panel boards Mechanical engineering
Contact Data			
Contact arrangement	1 form C, (CO)	1 form C, (1 CO) 2 form C, (2 CO)	1 form C, (1 CO) 2 form C, (2 CO)
Rated voltage	250VAC	240VAC	240VAC
Rated current	6A	8/16A	8/16A
Switching power / Max. break	1500VA	2000/4000VA	2000/4000VA
Contact material	AgSnO ₂ , AgSnO ₂ Au plated	AgSnO ₂ , AgNi90/10 AgNi90/10 Au plated	AgNi90/10
Min. recommended contact load	1) see footnote below	1) see footnote below	10mA at 12VDC
Coil Data			
Magnetic system	DC	DC, AC	DC, AC
Rated coil voltage	5 to 60VDC	5 to 110VDC/24 to 230VAC	12 to 110VDC/24 to 230VAC
Rated coil power	170mW	400mW/0.75VA	400mW/0.75VA
Dielectric Strength			
Initial dielectric strength			
between open contacts	1000Vrms	1000Vrms	1000Vrms
between contact and coil	4000Vrms	4000/5000Vrms	4000/5000Vrms
between adjacent contacts		2500Vrms	2500Vrms
Clearance/creepage			
between contact and coil	≥6/8mm	≥8/8mm	≥8/8mm
Other Data			
Ambient temperature (max.)	Relay +85°C, in socket +55°C	+70/+85°C	+70/+85°C
Category of environmental protection IEC61810	RTIII	RTII	RTII
Terminal type	Plug-in	Plug-in	Plug-in
Mounting	Socket	Socket	Socket
Dimensions (lwh)	28x5x15mm	29x13x15.7mm	29x13x26.7mm
Accessories	DIN rail sockets, jumper bars	DIN rail and PCB sockets, clips, marking tags, modules, jumper bars	DIN rail and PCB sockets, clips, marking tags, modules, jumper bars
Link to datasheet	SCHRACK SLIM INTERFACE SNR	SCHRACK INTERFACE RELAY RT	SCHRACK INTERFACE RELAY XT

1) Recommended minimum load indication for contact material: AU and gold plated: 1mA at 6VDC; AgNi015 and AgNi90/10: 10mA at 12VDC; AgCdO and AgSnO₂: 100mA at 12VDC. Please contact technical support for detailed technical data. 2) Footprint images are representative. For a complete selection, refer to the TE data sheet via the link above.

Panel Plug-In Relays

Relays, Contactors & Circuit Breakers

Key Features

Potter & Brumfield R10

Broad range of coil options provide sensitivity ranging from 25 to 750mW
Various contacts switch from dry circuit to 7.5A
Many mounting and termination options

SCHRACK PT/ Potter & Brumfield KH

Sensitive coil
Low height 29/33mm
Manual test tab, optionally lockable
Mechanical indicator
Optional LED, protection diode

Potter & Brumfield K10

Mounting options include socket, PCB, top flange
DC and AC coils
LED versions available



Footprint

2) see footnote below

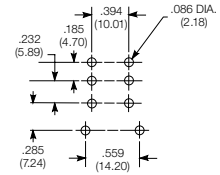
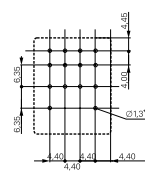
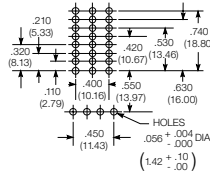

Applications	Coin changers Audio equipment Ultrasonic test equipment	Machine industry Elevator industry Building management	Industrial controls Motor controls Industrial timers
Contact Data			
Contact arrangement	1, 2, 3, 4, 6, 8 form C (CO)	2 form C (2 CO) 3 form C (3 CO) 4 form C (4 CO)	2 form C (2 CO)
Rated voltage	115VAC, 115VDC	240VAC	120/240VAC
Rated current	0.5/2/3/7.5A	1/2/5/6/10/12A	10/15A
Switching power / Max. break	862VA max.	1500/2500/3000VA	1800/2500VA
Contact material	Ag, AgCdO, Ag w/ Au overlay	AgNi90/10, AgNi90/10 Au plated	AgCdO, AgNi90/10
Min. recommended contact load	Dry circuit to 300mA at 12VDC	1) Bifurcated contacts for dry circuit available on KH	1) see footnote below
Coil Data			
Magnetic system	DC, AC	DC, AC	DC, AC
Rated coil voltage	3 to 115VDC/6 to 115VAC	6 to 220VDC/6 to 240VAC	6 to 220VDC/6 to 240VAC
Rated coil power	36mW to 1.6W/1.5VA	750 to 900mW/1 to 1.2VA	750 to 900mW/1 to 1.2VA
Dielectric Strength			
Initial dielectric strength			
between open contacts	500/1000Vrms	1200Vrms	1200/1000Vrms
between contact and coil	1000Vrms	2500Vrms	2500/1500Vrms
between adjacent contacts	1000Vrms	2000/2500Vrms	2500/1500Vrms
Clearance/creepage			
between contact and coil	Visit TE.com for more information	≥4/4mm	≥3.1/3.1mm
Other Data			
Ambient temperature (max.)	+75°C	+70°C	+70°C
Category of environmental protection IEC61810	RTI, RTIII	RTII	RTII
Terminal type	Solder/plug-in and PCB	THT, plug-in, Quick connect	Quick connect, solder, PCB
Mounting	Socket, panel mount and PCB	Socket, PCB	Socket and bracket mount
Dimensions (lwh)	29.6x18.7x30.2mm	28x22.5x29/30/36mm	28x22.5x29/34.9mm
Accessories			
	Solder/PCB sockets, clips, hold down strap, mounting strip	DIN rail and PCB sockets, clips, marking tags, modules, jumper bars	Screw, solder and PCB sockets and clips
Link to datasheet			
	POTTER & BRUMFIELD R10	Potter & Brumfield KHA SCHRACK PT	POTTER & BRUMFIELD K10

1) Recommended minimum load indication for contact material: AU and gold plated: 1mA at 6VDC; AgNi015 and AgNi90/10: 10mA at 12VDC; AgCdO and AgSnO₂: 100mA at 12VDC. Please contact technical support for detailed technical data. 2) Footprint images are representative. For a complete selection, refer to the TE data sheet via the link above.

Panel Plug-In Relays

Relays, Contactors & Circuit Breakers

Key Features

Potter & Brumfield KRPA/MT

Industry standard octal/undecal type termination for quick installation
DC and AC coils
Mechanical indicator, indicator lamp and push-to-test options



SCHRACK RM2/3/7

Wide selection of termination and mounting styles
PC terminals available
Push to test button and indicator lamps
Class B coil insulation

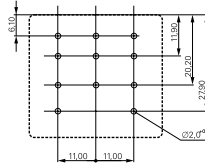

Potter & Brumfield KUP/KUMP/KUIP

Wide selection of termination and mounting styles
Broad range of contact forms
PC terminals available
Push to test button and indicator lamps
Class B coil insulation

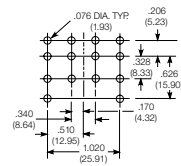

Footprint

2) see footnote below

PCB mount not applicable. Visit TE.com for more information

Applications	Mechanical engineering Elevator control, Plant control Baggage handling	Elevator control Power supplies	HVAC Pump motor controls Hospital beds
Contact Data			
Contact arrangement	1 form C (1 CO) (KRPA) 2 form C (2 CO) 3 form C (3 CO)	2 form C (2 CO) 3 form C (3 CO)	1, 2, 3, 4 form C (CO) 1, 2, 3 form A (NO) 2, 3 form B (NC) 1 form X (NO-DM) 1 form Y (NC-DB) 1 form Z (CO-DM/DB)
Rated voltage	240VAC	400VAC	240VAC
Rated current	4/10A	10/16A	10/15A
Switching power / Max. break	500/2400/2500VA	3800/6000VA	2400/4155VA
Contact material	AgCdO, AgNi90/10, AgNi90/10 Au plated	AgCdO, AgNi90/10 in preparation	Ag, AgCdO, AgSnOInO
Min. recommended contact load	1) see footnote below	100mA at 12VDC	100mA at 12VDC(Ag) 300mA at 12VDC (AgCdO, AnSnOInO)
Coil Data			
Magnetic system	DC, AC	DC, AC	DC, AC
Rated coil voltage	6 to 220VDC/6 to 240VAC	6 to 220VDC/6 to 400VAC	5 to 110VDC/6 to 240VAC
Rated coil power	760mW to 1.3W/0.74 to 2.3VA	1.2 to 1.8W/2 to 2.8VA	1.2 to 1.8W/2 to 2.7VA
Dielectric Strength			
Initial dielectric strength			
between open contacts	1000/1500Vrms	1500Vrms	1200Vrms
between contact and coil	1000/2500Vrms	2500Vrms	2200/3750Vrms
between adjacent contacts	1000/2500Vrms	2500Vrms	2200Vrms
Clearance/creepage			
between contact and coil	≥2.8/4mm	≥4/14.9mm	Visit TE.com for more information
Other Data			
Ambient temperature (max.)	DC +60/+70°C AC +50/+55°C	+50/+70°C	DC +50/+70/+95°C AC +45/+55/+70°C
Category of environmental protection IEC61810	RTI	RTI	RTI
Terminal type	Plug-in	THT, Plug-in, solder, Quick connect	THT, Plug-in, solder, Quick connect
Mounting	Socket	Socket, PCB, bracket, flange mount and DIN-snap-on	Socket, PCB, bracket, flange, stud and tapped core
Dimensions (lwh)	35.7x35.7x50.8/57mm	38.5x35.5x48.5mm	38.9x35.7x48.4mm
Accessories	DIN rail and PCB sockets, clips, marking tags, modules	DIN rail and PCB sockets, clips	DIN rail, panel and PCB sockets, clips
Link to datasheet	POTTER & BRUMFIELD KRPA SCHRACK MT	SCHRACK RM2/3/7	Potter & Brumfield KUIP KUGP KUM KUMP KUP

1) Recommended minimum load indication for contact material: AU and gold plated: 1mA at 6VDC; AgNi015 and AgNi90/10: 10mA at 12VDC; AgCdO and AgSnO₂: 100mA at 12VDC. Please contact technical support for detailed technical data. 2) Footprint images are representative. For a complete selection, refer to the TE data sheet via the link above.



Panel Plug-In Relays

Relays, Contactors & Circuit Breakers

Key Features

SCHRACK RM8/C/D

Power relay with push-on and solder terminals
 Various mounting options
 Indicator lamps and mechanical indicator
 Optional push to test button

Potter & Brumfield KUHP

Power relay with push-on and solder terminals
 Various mounting options
 Designed to meet VDE space requirements
 Class B coil insulation

SCHRACK RM5/6/B 3MM

3mm contact gap
 DC or AC coil
 Push-to-test button
 Plug-in version, PCB terminals or chassis or DIN-rail mount

Footprint

2) see footnote below



PCB mount not applicable.
 Visit TE.com for more information

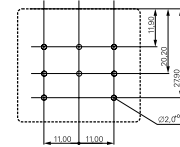
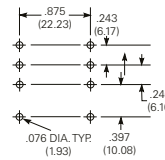

Applications	Cleaning equipment Heating equipment Cooling equipment	Baggage handling motors Industrial pumps Commercial ovens	Power supplies Pump control
--------------	--	---	--------------------------------

Contact Data	SCHRACK RM8/C/D	POTTER & BRUMFIELD KUHP	SCHRACK RM5/6/B 3MM
Contact arrangement	1 form C (1 CO) 2 form C (2 CO) 1 form Z contact (1 NO + 1 NC) 1 form X contact (1 NO)	1 form C (1 CO) 2 form C (2 CO)	2 form A (2 NO) 3 form A (3NO)
Rated voltage	400VAC	240VAC, 50/60Hz; 28VDC	240/400VAC
Rated current	25/30/32A	20/30A	10/16A
Switching power / Max. break	6000/7500VA	4800/7200VA	3800/6000VA
Contact material	AgCdO, AgNi90/10	AgCdO, AgSnOInO	AgCdO, AgNi90/10 in preparation
Min. recommended contact load	100mA at 12VDC	300mA at 12VDC	100mA at 12VDC

Coil Data	SCHRACK RM8/C/D	POTTER & BRUMFIELD KUHP	SCHRACK RM5/6/B 3MM
Magnetic system	DC, AC	DC, AC	DC, AC
Rated coil voltage	6 to 220VDC/6 to 400VAC	6 to 110VDC 50/60Hz. 6 to 277VAC	6 to 220VDC/6 to 400VAC
Rated coil power	1.2W/2.7VA	1.2W/2.7VA	1.2W/2.7VA

Dielectric Strength	SCHRACK RM8/C/D	POTTER & BRUMFIELD KUHP	SCHRACK RM5/6/B 3MM
Initial dielectric strength			
between open contacts	1500/2000Vrms	1200Vrms	2500Vrms
between contact and coil	2500Vrms	3750Vrms	2500Vrms
between adjacent contacts	4000Vrms	3750Vrms	2500Vrms
Clearance/creepage			
between contact and coil	≥4/14.9mm	Visit TE.com for more information	≥4/14.9mm

Other Data	SCHRACK RM8/C/D	POTTER & BRUMFIELD KUHP	SCHRACK RM5/6/B 3MM
Ambient temperature (max.)	DC +60/+65°C AC +40°C	DC +45°C AC +75°C	+50/+60°C
Category of environmental protection IEC61810	RTI	RTI, RTO	RTI
Terminal type	Solder/Quick connect	Solder/PCB THT/Quick connect	Plug-in, solder, Quick connect, PCB THT
Mounting	Bracket, top flange panel mount and DIN snap-on	Bracket and top flange panel mount	Socket, PCB, bracket, flange mount and DIN-snap-on
Dimensions (lwh)	38.5x35.5x48.5mm	38.9x35.7x48.4mm	38.5x35.5x48.5mm

Accessories	SCHRACK RM8/C/D	POTTER & BRUMFIELD KUHP	SCHRACK RM5/6/B 3MM
	No sockets	No sockets	DIN rail and PCB sockets, clips

Link to datasheet	SCHRACK RM8C/D SCHRACK RM 8	POTTER & BRUMFIELD KUHP	SCHRACK RM5/6/B 3MM
-------------------	--	---	-------------------------------------

1) Recommended minimum load indication for contact material: AU and gold plated: 1mA at 6VDC; AgNi015 and AgNi90/10: 10mA at 12VDC; AgCdO and AgSnO₂: 100mA at 12VDC. Please contact technical support for detailed technical data. 2) Footprint images are representative. For a complete selection, refer to the TE data sheet via the link above.



Panel Plug-In Relays

Relays, Contactors & Circuit Breakers

Key Features

Potter & Brumfield KUGP

3mm contact gap
DC or AC coil
Plug-in version, PCB terminals or chassis mount

Potter & Brumfield KUL

Magnetic latching
Single and dual coils
Panel mounting

Potter & Brumfield KUEP

10A relay with various contact arrangements
Magnetic blowout for 150VDC load switching
Indicator lamp option

Footprint

2) see footnote below

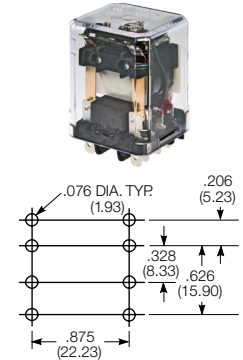
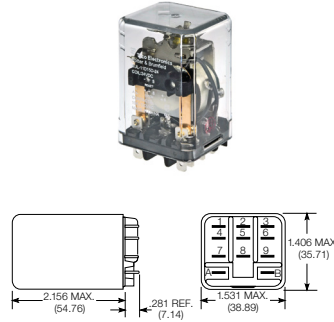
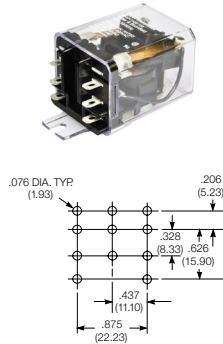

Applications

Voltage control units

Alarm systems
Machine tools
Battery chargers

DC load switching in industrial controls

Contact Data

Contact arrangement	1 form C (1 CO) 2 form A (2 NO) 2 form C (2 CO) 3 form C (3 CO)	1 form C (1 CO) 2 form C (2 CO) 3 form C (3 CO)	1 form X (NO-DM) 2 form A (2 NO) 2 form C (2 CO)
Rated voltage	240/400VAC	28/240VAC	150VDC/240VAC
Rated current	10A	10A	10A
Switching power / Max. break	2400VA		1500W/2400VA
Contact material	Ag, AgCdO	Ag, AgCdO	AgCdO, AgSnOInO
Min. recommended contact load	100mA at 12VDC (Ag) 300mA at 12VDC (AgCdO)	100mA at 12VDC (Ag) 300mA at 12VDC (AgCdO)	300mA at 12VDC

Coil Data

Magnetic system	DC, AC	DC, AC	DC, AC
Rated coil voltage	6-110VDC/6-240VAC	12 to 48VDC/24 to 120/240VAC	5 to 110VDC/6 to 240VAC
Rated coil power	1.8W/2.7VA	1.6W dual coil/1.2W single coil	1.2W to 1.8W/2 to 2.7VA

Dielectric Strength

Initial dielectric strength			
between open contacts	3500Vrms	500Vrms	1200Vrms
between contact and coil	2200Vrms	1500Vrms	2200Vrms
between adjacent contacts	2200Vrms	1500Vrms	2200Vrms
Clearance/creepage			
between contact and coil	>8mm	Visit TE.com for more information	Visit TE.com for more information

Other Data

Ambient temperature (max.)	DC +75°C AC +70°C	DC +70°C AC +50/+70°C	AC +55/+70°C DC +50/+70°C
Category of environmental protection IEC61810	RTI	RTI	RTI
Terminal type	THT, Plug-in, solder, Quick connect, PCB	.187 Quick connect, solder	Quick connect, solder and PCB
Mounting	Socket, PCB, bracket, flange mount	Socket, bracket	Socket, PCB, bracket and top flange mount
Dimensions (lwh)	38.9x35.7x48.4mm	38.9x35.7x54.8mm	38.9x35.7x48.4mm

Accessories

DIN rail and PCB sockets, clips

Screw, solder, PCB and Quick connect sockets and clips

DIN rail, track mount, chassis mount, and snap-in sockets, clips

Link to datasheet

[POTTER & BRUMFIELD KUGP](#)

[POTTER & BRUMFIELD KUL](#)

[POTTER & BRUMFIELD KUEP](#)

1) Recommended minimum load indication for contact material: AU and gold plated: 1mA at 6VDC; AgNi0.15 and AgNi90/10: 10mA at 12VDC; AgCdO and AgSnO₂: 100mA at 12VDC. Please contact technical support for detailed technical data. 2) Footprint images are representative. For a complete selection, refer to the TE data sheet via the link above.



Panel Plug-In Relays

Relays, Contactors & Circuit Breakers

Key Features

ACCESSORIES

DIN rail and PCB sockets
Screw and screwless fingersafe terminals
Retaining and ejection clips
Marking tags, jumper bars, jumper links
LED and protection modules

SETS

Relay package consisting of relay, DIN rail socket, plastic retaining clip, marking tag and module

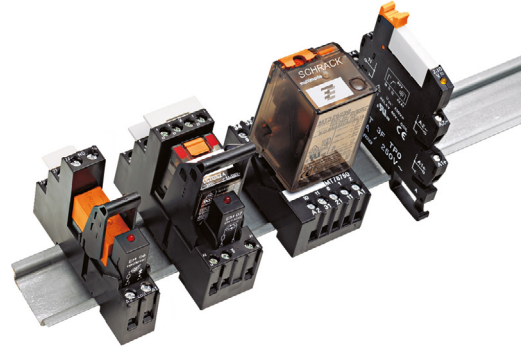

Applications

Contact Data

Contact arrangement	1 form C (1 CO) 2 form C (2 CO) 3 form C (3 CO) 4 form C (4 CO)	1 form C (1 CO) 2 form C (2 CO) 3 form C (3 CO) 4 form C (4 CO)
Rated voltage	240/250VAC	240/250VAC
Rated current	6 to 16A	6 to 16A
Switching power / Max. break		1500 to 4000VA
Min. recommended contact load		1) see footnote below

Coil Data

Magnetic system	DC, AC
Rated coil voltage	6 to 220VDC/6 to 230VAC
Rated coil power	170 to 700mW/0.4 to 1VA

Dielectric Strength

Initial dielectric strength
between open contacts
between contact and coil
between adjacent contacts
Clearance/creepage
between contact and coil

Other Data

Ambient temperature (max.)		
Category of environmental protection IEC61810	IP20	
Terminal type	Screw, screwless, plate mount, PCB	Screw, screwless
Mounting		
Dimensions (lwh)		

Accessories	PCB, panel mount and DIN rail	DIN, panel mount
-------------	-------------------------------	------------------

Link to datasheet	ACCESSORIES SLIM INTERFACE RELAY SNR ACCESSORIES INDUSTRIAL POWER RELAY RT ACCESSORIES MINIATURE RELAY PT ACCESSORIES INTERFACE PLUG-IN RELAY XT	RELAY PACKAGE RT RELAY PACKAGE PT RELAY PACKAGE SNR ACCESSORIES MULTIMODE RELAY MT
-------------------	---	---

1) Recommended minimum load indication for contact material: AU and gold plated: 1mA at 6VDC; AgNi0.15 and AgNi90/10: 10mA at 12VDC; AgCdO and AgSnO₂: 100mA at 12VDC. Please contact technical support for detailed technical data.

Signal Relays

Relays, Contactors & Circuit Breakers

Key Features

Axicom IM

4G telecom/signal relay/switching relay
Slim line 10x6mm, low-profile 5.65mm
Switching power 60W/62.5VA
Switching voltage 220VDC/250VAC
Monostable + Bistable
Low rated coil power
High dielectric version
High current version up to 5 A
High contact stability version
Bifurcated contacts + single contact

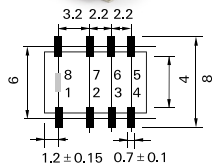
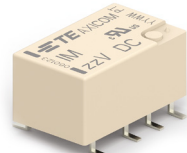

Axicom IMB

4G telecom/signal relay/switching relay
Slim line 10x6mm, low-profile 5.65mm
Switching power 60W/62.5VA
Switching voltage 220VDC/250VAC
Monostable + Bistable
Very high dielectric version
Bifurcated contacts

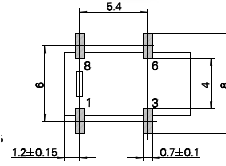
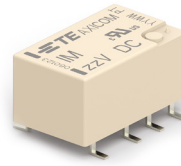

Axicom IMC

4G telecom/signal relay/switching relay
Slim line 10x6mm, low-profile 5.65mm
Switching power 60W/62.5VA
Switching voltage 220VDC/250VAC
Monostable + Bistable
High dielectric version
High current version up to 4 A
Bifurcated contacts

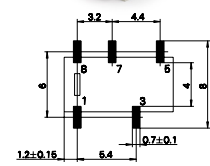
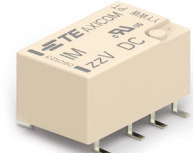

Footprint

2) see footnote below

Applications

Telecommunication, access and transmission equipment
Thermostat controls, fire and security equipment
Measurement and test equipment, Industrial controls, medical equipment

Telecommunication, access and transmission equipment
Thermostat controls, fire and security equipment
Measurement and test equipment, Industrial controls, medical equipment

Telecommunication, access and transmission equipment
Thermostat controls, fire and security equipment
Measurement and test equipment, Industrial controls, medical equipment

Contact Data

Contact arrangement	2 form C, 2 CO Single contact + Bifurcated contacts	1 form A, 1 NO Bifurcated contacts	1 form C, 1 CO Bifurcated contacts
Rated voltage	250VAC/220VDC	250VAC/220VDC	250VAC/220VDC
Rated current	2/5A	2A	2/4A
Switching power / Max. break	60W/62.5VA	60W/62.5VA	60W/62.5VA
Min. recommended contact load	100µV/1µA	100µV/1µA	100µV/1µA
Initial contact resistance	<50mΩ at 10mA/30mV I: < 100mΩ	<100mΩ at 10mA/30mV	<50mΩ at 10mA/ 30mV

Coil Data

Magnetic system	Polarized	Polarized	Polarized
Rated coil voltage	1.5 to 24VDC	1.5 to 24VDC	1.5 to 24VDC
Rated coil power	50 to 200mW/-/	140mW/-/	140mW/-/
DC coil / bistable 1 coil/2 coils			

Dielectric Strength

Initial dielectric strength			
between open contacts	750 to 1500Vrms	2500Vrms	1000 to 1600Vrms
between contact and coil	1500 to 1800Vrms	3500Vrms	1800 to 2200Vrms
between adjacent contacts	750 to 1800Vrms		
Initial surge withstand voltage			
between open contacts	1000 to 2500V	3500V	1500 to 2200V
between contact and coil	2000 to 2500V	4900V	2500 to 3000V
between adjacent contacts	1000 to 2500V		
Isolation 100/900MHz	37.0/18.8dB	37.0/18.8dB	37.0/18.8dB
Insertion loss 100/900MHz	0.03/0.33dB	0.03/0.33dB	0.03/0.33dB
Volt. standing wave ratio 100/900MHz	1.06/1.49	1.06/1.49	1.06/1.49
Capacitance			
between open contacts	max. 1pF	max. 1pF	max. 1pF

Other Data

Ambient temperature (max.)	-40 to +85°C	-40 to +85°C	-40 to +85°C
Category of environmental protection	IP67/RTV	IP67/RTV	IP67/RTV
Terminal type	THT, SMT	THT, SMT	THT, SMT
Dimension (lwh)	10x6x5.65mm	10x6x5.65mm	10x6x5.65mm

Link to datasheet

[AXICOM IM](#)

[AXICOM IMB](#)

[AXICOM IMC](#)

1) Recommended minimum load indication for contact material: AU and gold plated: 1mA at 6VDC; AgNi0.15 and AgNi90/10: 10mA at 12VDC; AgCdO and AgSnO₂: 100mA at 12VDC. Please contact technical support for detailed technical data.

2) Footprint images are representative. For a complete selection, refer to the TE data sheet via the link above.

Signal Relays

Relays, Contactors & Circuit Breakers

Key Features

Axicom IMD/IME

4G telecom/signal relay/switching relay
Slim line 10x6mm, low-profile 5.65mm
Switching power 60W/62.5VA
Switching voltage 220VDC/250VAC
Monostable
Bifurcated contacts

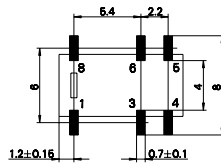
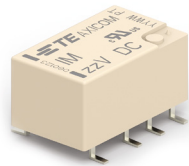

Axicom P2 / P2 HIGH DIELECTRIC VERSION

Small Signal relay
Slim line 15x7.5mm
Switching current max. 5A
High dielectric version
Meets Telcordia Technologies Inc. requirements

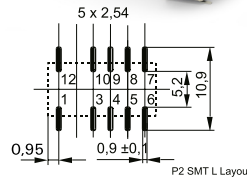
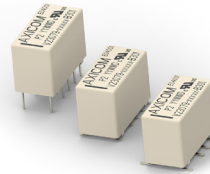

Axicom P2 LIGHTING

Small signal relay
Slim line 15x7.5mm
Switching current max. 5A
High dielectric strength 3kV
VDE certified for LED tubes

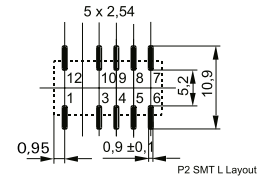
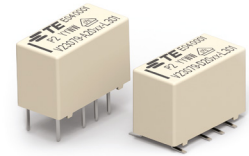

Footprint

2) see footnote below

Applications

Telecommunication, access and transmission equipment, fire and security equipment
Thermostat controls
Measurement and test equipment, Industrial controls, medical equipment

Security systems, consumer electronics, thermostats
Home automation systems, communication systems
Set top boxes, office equipment

LED tubes
Office equipment
Security systems, set top boxes

Contact Data

Contact arrangement	2 form B, 2 NC 2 form A, 2 NO Bifurcated contacts	2 form C, 2 CO Bifurcated contacts	2 form C, 2 CO Bifurcated contacts
Rated voltage	250VAC/220VDC	250VAC/220VDC	250VAC/220VDC
Rated current	2A	2A	2A
Switching power / Max. break	60W/62.5VA	60W/62.5VA	60W/62.5VA
Min. recommended contact load	100μV/1μA	100μV/1μA	100μV/1μA
Initial contact resistance	<50mΩ at 10mA/20mV	<50mΩ at 10mA/20mV	<50mΩ at 10mA/20mV

Coil Data

Magnetic system	Polarized	Polarized	Polarized
Rated coil voltage	1.5 to 24VDC	2.4 to 24VDC	3 to 12VDC
Rated coil power DC coil / bistable 1 coil/2 coils	140mW/-/-	140mW/70mW/140mW	140mW - 1 coil version

Dielectric Strength

Initial dielectric strength			
between open contacts	1000Vrms	1000 to 1500Vrms	1500Vrms
between contact and coil	1800Vrms	1500Vrms	3000Vrms
between adjacent contacts	1000Vrms	1000 to 1500Vrms	1500Vrms
Initial surge withstand voltage			
between open contacts	1500V	2000 to 2500Vrms	
between contact and coil	2500V	2500V	6000Vrms
between adjacent contacts	1500V	2500V	
Isolation 100/900MHz	37.0/18.8dB		
Insertion loss 100/900MHz	0.03/0.33dB		
Volt. standing wave ratio 100/900MHz	1.6/1.49		
Capacitance			
between open contacts	max. 1pF		

Other Data

Ambient temperature (max.)	-40 to +85°C	-40 to +85°C	-40 to +85°C
Category of environmental protection	IP67/RTV	RTIII	RTIII
Terminal type	THT, SMT	THT, SMT	THT, SMT
Dimension (lwh)	10x6x5.65mm	14.5x7.2x10.4mm, stnd 14.5x7.2x9.9mm, ovrmld	14.5x7.2x9.9mm, ovrmld

Link to datasheet

[AXICOM IMD/IME](#)

[AXICOM P2 / P2 HIGH DIELECTRIC VERSION](#)

[AXICOM P2 LIGHTING](#)

1) Recommended minimum load indication for contact material: Au and gold plated: 1mA at 6VDC; AgNi0.15 and AgNi90/10: 10mA at 12VDC; AgCdO and AgSnO₂: 100mA at 12VDC. Please contact technical support for detailed technical data. 2) Footprint images are representative. For a complete selection, refer to the TE data sheet via the link above.

Signal Relays

Relays, Contactors & Circuit Breakers

Key Features

Axicom FP2

Slim line 14x9mm
2 form C bifurcated contacts
High mechanical shock resistance, up to 1500g survival

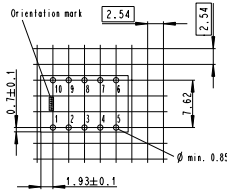
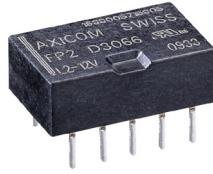

Axicom D2N V23105

2G telecom/signal relay
4 coil sensitivities
3A UL rating

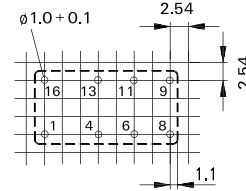
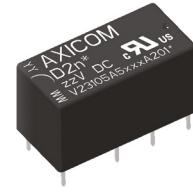

Footprint

2) see footnote below

Applications

Communication equipment
Keyless entry
Speaker switch, consumer electronics

Communication equipment
Office equipment
Measurement and control equipment

Contact Data

Contact arrangement	1 form C (CO)	2 form C, 2 CO Single Contacts
Rated voltage	220VDC/250VAC	250VAC/220VDC
Rated current	2A	3A
Switching power / Max. break	60W/62.5VA	60W/125VA
Min. recommended contact load	100μV	100μV/10μA
Initial contact resistance	<50mΩ at 10mA	<100mΩ

Coil Data

Magnetic system	Polarized	Non polarized
Rated coil voltage	2 to 24VDC	3 to 48VDC
Rated coil power DC coil/bistable 1 coil/2 coils	80mW (high sensitive), 140mW	150 to 700mW/-/-

Dielectric Strength

Initial dielectric strength		
between open contacts	750Vrms	750Vrms
between contact and coil	1000Vrms	1000Vrms
between adjacent contacts	1000Vrms	750Vrms
Initial surge withstand voltage		
between open contacts	1100V	1500V
between contact and coil	1500V	1500V
between adjacent contacts	1500V	1500V
Isolation/Cross talk at 100MHz/900MHz	Cross talk -40.2/-22.3dB	Isolation -39.0/-20.7dB
Insertion loss 100/900MHz	0.03dB/0.25dB	-0.02/-0.27dB
Volt. standing wave ratio 100/900MHz	1.01/1.07	1.04/1.40
Capacitance between open contacts		max. 2pF

Other Data

Ambient temperature (max.)	-40 to +85°C	-25 to +85°C
Category of environmental protection	IP67/RTIII	IP67/RTIII
Terminal type	THT	THT
Dimension (lwh)	14x9x5mm	20.2x10x11.4mm

Link to datasheet

[AXICOM FP2](#)

[AXICOM D2N V23105](#)

1) Recommended minimum load indication for contact material: AU and gold plated: 1mA at 6VDC; AgNi0.15 and AgNi90/10: 10mA at 12VDC; AgCdO and AgSnO₂: 100mA at 12VDC. Please contact technical support for detailed technical data. 2) Footprint images are representative. For a complete selection, refer to the TE data sheet via the link above.

Signal Relays

Relays, Contactors & Circuit Breakers

Key Features

Axicom MT2

2G telecom/signal relay
5 coil sensitivities
2A UL rating

Axicom P1 V23026

Very high sensitive relay
Low-profile
High vibration and shock resistance
Version: symmetric pin layout
Temperature range up to 85°C
1500Vrms across opened contacts

Footprint

2) see footnote below

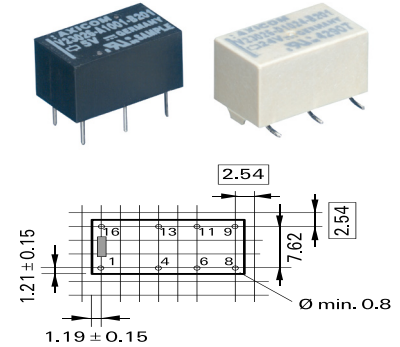
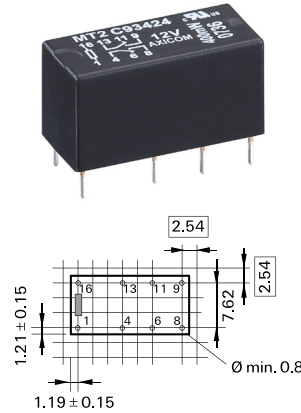

Applications	Communication equipment Linecard application Measurement and control equipment	Automotive equipment CAN bus Imobilizer
Contact Data		
Contact arrangement	2 form C, 2 CO Bifurcated contacts	1 form C, 1 CO Bifurcated contacts
Rated voltage	250VAC/220VDC	150VAC/125VDC
Rated current	2A	1A
Switching power / Max. break	60W/62.5VA	30W/60VA
Min. recommended contact load	100µV/1µA	100µV/1µA
Initial contact resistance	<70mΩ	<50mΩ
Coil Data		
Magnetic system	Non polarized	Polarized
Rated coil voltage	3 to 48VDC	3 to 24VDC
Rated coil power	150 to 550mW/-/-	65 to 130mW/30 to 130mW/70 to 200mW
DC coil/bistable 1 coil/2 coils		
Dielectric Strength		
Initial dielectric strength		
between open contacts	750Vrms	500Vrms
between contact and coil	1000Vrms	1500Vrms
between adjacent contacts	750Vrms	
Initial surge withstand voltage		
between open contacts	1500V	
between contact and coil	1500V	2500V
between adjacent contacts	1500V	
Isolation 100/900MHz	-31.8/-14.2dB	-30.0/-18.0dB
Insertion loss 100/900MHz	-0.02/-0.97dB	-0.12/-1.90dB
Volt. standing wave ratio 100/900MHz	1.03/1.31	1.06/1.75
Capacitance		
between open contacts	max. 2pF	max. 5pF
Other Data		
Ambient temperature (max.)	-55 to +85°C	-40 to +85°C
Category of environmental protection	IP67/RTIII	IP67/RTIII
Terminal type	THT	THT, SMT
Dimension (lwh)	20.2x10x11mm	13x7.6x6.9mm
Link to datasheet	AXICOM MT2	AXICOM P1 V23026

1) Recommended minimum load indication for contact material: AU and gold plated: 1mA at 6VDC; AgNi0.15 and AgNi90/10: 10mA at 12VDC; AgCdO and AgSnO₂: 100mA at 12VDC. Please contact technical support for detailed technical data.

2) Footprint images are representative. For a complete selection, refer to the TE data sheet via the link above.

Signal Relays

Relays, Contactors & Circuit Breakers

Key Features

Axicom REED DIP/SIL

Direct driving with TTL signals
 Ultrasonic cleanable
 High switching speed
 Clamping diode
 Electrostatic shield



TSC

Designed for thermostat, modem
 Computer peripherals, video
 recording and security application
 Low coil power requirements
 IC compatibility



OUAZ/T81

Gold overlay silver palladium alloy
 contact suitable for low loads
 High density available on PCB due to
 small size
 2.54mm terminal pitch same as IC
 socket terminal pitch
 Sensitive and standard coils



Footprint

2) see footnote below

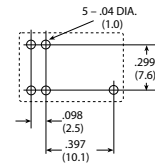
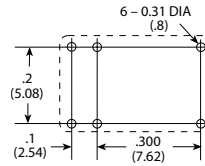
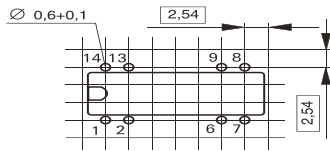

Applications	Incircuit tester Measuring and control systems Alarm and security equipment	Telecommunications Office machine	Telecommunications Logic and process control Vending machines
Contact Data			
Contact arrangement	1 form A, 1 NO 2 form A, 2 NO 1 form C, 1 CO Reed contacts	1 form C, 1 CO	1 form C, 1 CO 1 form A, 1 NO
Rated voltage	175 to 200VAC/VDC	120VAC, 30VDC	120VAC/24VDC
Rated current	0.25 to 0.5A	1A	1A
Switching power / Max. break	3 to 10W	120VA, 24W	120VA, 30W
Min. recommended contact load	10μV/1μA	1mA at 1VDC	1mA at 1VDC
Initial contact resistance	<150mΩ	50mΩ at 100mA, 6VDC	
Coil Data			
Magnetic system	Non polarized	DC, sensitive	DC, sensitive
Rated coil voltage	5 to 24VDC	3 to 24VDC	5 to 24VDC
Rated coil power	50 to 300mW/-/- DC coil/bistable 1 coil/2 coils	150, 300mW	200, 450mW
Dielectric Strength			
Initial dielectric strength			
between open contacts	140 to 175Vrms	400Vrms	500Vrms
between contact and coil	500vdc	1000Vrms	1000Vrms
between adjacent contacts	500vdc		
Initial surge withstand voltage			
between open contacts			
between contact and coil		1500Vp (10/160μs)	1500Vp (10/160μs)
between adjacent contacts			
Isolation 100/900MHz			
Insertion loss 100/900MHz			
Volt. standing wave ratio 100/900MHz			
Capacitance			
between open contacts	max. 1pF		
Other Data			
Ambient temperature (max.)	-20 to +70°C	40 to +80°C	-40 to +60°C (standard)
Category of environmental protection	IP67/RTIII	RTIII/IP67	RTII, RTIII
Terminal type	THT	THT	THT
Dimension (lwh)	19.3x5.7x7.5mm/19.8x5.1x8mm	12.5x7.5x10mm	15.4x10.4x11.2mm
Link to datasheet	AXICOM REED DIP/SIL	TSC	OUAZ/T81

1) Recommended minimum load indication for contact material: AU and gold plated: 1mA at 6VDC; AgNi0.15 and AgNi90/10: 10mA at 12VDC; AgCdO and AgSnO₂: 100mA at 12VDC. Please contact technical support for detailed technical data. 2) Footprint images are representative. For a complete selection, refer to the TE data sheet via the link above.



High Frequency Relays

Relays, Contactors & Circuit Breakers

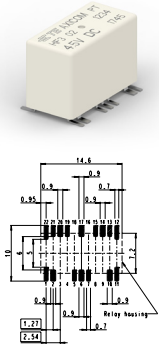
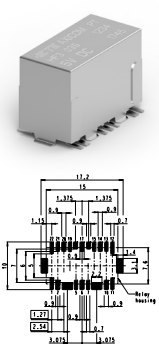
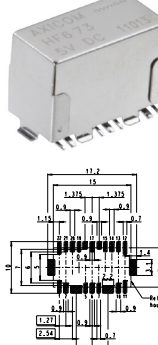
	Axicom HF3	Axicom HF3S	Axicom HF6
Key Features	High performance RF relay/switch for up to 3GHz Low power consumption $\leq 70/140$ mW 50 and 75 Ω version Very small design	High performance RF relay/switch for up to 3GHz Low power consumption $\leq 70/140$ mW 50 and 75 Ω version RF power 100W at 2GHz Very small design	High performance RF relay/switch for up to 6GHz Low power consumption $\leq 70/140$ mW 50 Ω version Very small design
Footprint 2) see footnote below			
Applications	Cable modems and linecards/CATV Measurement and test equipment ATE Satellite/audio/video tuners	Cable modems and linecards/CATV Measurement and test equipment ATE Satellite/audio/video tuners	Measurement and test equipment ATE Wireless base stations and antennas Wireless infrastructure
Contact Data	1 form C, 1 CO Bridge contacts Rated voltage 250VAC/220VDC Rated current 2A Switching power / Max. break 60W/62.5VA/50W (2.5GHz) Min. recommended contact load 100 μ V/1 μ A Initial contact resistance <100m Ω	1 form C, 1 CO Bridge contacts Rated voltage 250VAC/220VDC Rated current 2A Switching power / Max. break 60W/62.5VA/50W (2.5GHz) Min. recommended contact load 100 μ V/1 μ A Initial contact resistance <100m Ω	1 form C, 1 CO Bridge contacts Rated voltage 250VAC/220VDC Rated current 2A Switching power / Max. break 60W/62.5VA/50W (2.5GHz) Min. recommended contact load 100 μ V/1 μ A Initial contact resistance <100m Ω
Coil Data	Magnetic system Polarized Rated coil voltage 3 to 24VDC Rated coil power 140mW/70mW/140mW DC coil/bistable 1 coil/2 coils	Magnetic system Polarized Rated coil voltage 3 to 24VDC Rated coil power 140mW/70mW/140mW	Magnetic system Polarized Rated coil voltage 3 to 24VDC Rated coil power 140mW/70mW/140mW
Dielectric Strength	Initial dielectric strength between open contacts 600Vrms between contact and coil 1000Vrms between adjacent contacts 1000Vrms Initial surge withstand voltage between open contacts 1000Vp between contact and coil 1500Vp between adjacent contacts 1500Vp Capacitance between open contacts max. 1pF	Initial dielectric strength between open contacts 600Vrms between contact and coil 1000Vrms between adjacent contacts 1000Vrms Initial surge withstand voltage between open contacts 1000Vp between contact and coil 1500Vp between adjacent contacts 1500Vp Capacitance between open contacts max. 1pF	Initial dielectric strength between open contacts 600Vrms between contact and coil 1000Vrms between adjacent contacts 1000Vrms Initial surge withstand voltage between open contacts 1000Vp between contact and coil 1500Vp between adjacent contacts 1500Vp Capacitance between open contacts max. 1pF
RF Data	0.1/0.9/3GHz Isolation -80/-72/-DB45 Insertion loss -0.03/0.12/-0.35dB Voltage standing wave ratio (VSWR) 1.05/1.15/1.20	0.1/0.9/3GHz Isolation -95/-80/-55dB Insertion loss -0.03/-0.12/-0.30dB Voltage standing wave ratio (VSWR) 1.05/1.10/1.25	0.9/3/6GHz Isolation -80/-60/-30dB Insertion loss -0.05/-0.15/-0.80dB Voltage standing wave ratio (VSWR) 1.05/1.10/1.40
Other Data	Ambient temperature (max.) -55 to +85°C Category of environmental protection IP67/RTIII Terminal type SMT Dimension (lwh) 14.6x7.2x10mm	Ambient temperature (max.) -55 to +85°C Category of environmental protection IP67/RTIII Terminal type SMT Dimension (lwh) 15x7.6x10.6mm	Ambient temperature (max.) -55 to +85°C Category of environmental protection IP67/RTIII Terminal type SMT Dimension (lwh) 15x7.6x10.6mm
Link to datasheet	AXICOM HF3	AXICOM HF3S	AXICOM HF6

1) Recommended minimum load indication for contact material: AU and gold plated: 1mA at 6VDC; AgNi0.15 and AgNi90/10: 10mA at 12VDC; AgCdO and AgSnO₂: 100mA at 12VDC. Please contact technical support for detailed technical data. 2) Footprint images are representative. For a complete selection, refer to the TE data sheet via the link above.

Solid State Relays

Relays, Contactors & Circuit Breakers

Key Features

Potter & Brumfield SSR

Standard "hockey puck" package
Inverse parallel SCR output
240VAC & 480VAC output types
Zero voltage and random voltage turn-on versions
4,000Vrms optical isolation
Cover design with anti-rotation barriers
1 Form A (SPST-NO)



PCB mount not applicable.
Visit [TE.com](https://www.te.com) for more information

Potter & Brumfield SSRD

Two independent AC output solid state relays
Standard "hockey puck" package
Inverse parallel SCR output
4000Vrms optical isolation
Quick connect style termination
2 Form A (2 SPST-NO)



PCB mount not applicable.
Visit [TE.com](https://www.te.com) for more information

Potter & Brumfield SSRT

Standard "hockey puck" package
TRIAC Output
4,000Vrms optical isolation
Cover design with anti-rotation barriers
1 Form A (SPST-NO)



PCB mount not applicable.
Visit [TE.com](https://www.te.com) for more information

Typical Applications

Industrial machinery
HVAC
Building controls

Industrial machinery
HVAC
Building controls

Industrial machinery
HVAC
Building controls

Output Data

Load Voltage	24 - 280VAC/48 - 660VAC	24 - 280VAC	24 - 280VAC
Repetitive Blocking Voltage	600VAC/1200VAC	600VAC	600VAC
Load Current Range	25A/50A/125A	25A/40A	10A/25A
Leakage Current (Off-State)	5mA	5mA	5mA
On-State Voltage Drop (Max.)	1.8V	1.8V	1.6V
Load Power Factor Rating	0.5 - 1.0	0.5 - 1.0	0.5 - 1.0
Thermal Resistance, Junction to Case (R _{θJ-C}) (Max.)	2.35/0.55/0.35	2.35/0.86	2.4/1.7

Input Data (AC/DC)

Control Voltage Range VIN	90 - 280VAC/3 - 32VDC	4 - 15VDC	90 - 280VAC/3 - 32VDC
Must Operate Voltage VIN(OP) (Min.)	90VAC/3VDC	4VDC	90VAC/3VDC
Must release Voltage VIN(REL) (Min.)	10VAC/1VDC	1VDC	10VAC/1VDC
Input Current	2 - 26mA / 3 - 30mA	15mA @ 8VDC	25mA/20mA

Dielectric Strength

Isolation:	4000Vrms	4000Vrms	4000Vrms
------------	----------	----------	----------

Other Data

Dimensions	46.5x57.8x43.4mm	44.5x57.8x30.15mm	45x57.5x36.5mm
Operating Temperature	-30 to +80°C	-30 to +80°C	-30 to +80°C
Mounting	Panel	Panel	Panel
UL File No	E29244	E29244	E29244

Link to datasheet	POTTER & BRUMFIELD SSR	POTTER & BRUMFIELD SSRD	POTTER & BRUMFIELD SSRT
-------------------	--	---	---

1) Recommended minimum load indication for contact material: AU and gold plated: 1mA at 6VDC; AgNi0.15 and AgNi90/10: 10mA at 12VDC; AgCdO and AgSnO₂: 100mA at 12VDC. Please contact technical support for detailed technical data.

Solid State Relays

Relays, Contactors & Circuit Breakers

Key Features

Potter & Brumfield SSRDC

Standard "hockey puck" package
200VDC FET output
12A, 25A and 40A load current options
1500VDC optical isolation
Cover design with anti-rotation barriers
1 Form A (SPST-NO)

Potter & Brumfield SSRK

10-30A DIN mount Solid State Relay with integrated heat sink
Narrow 22.5mm design
Inverse parallel SCR output
240VAC & 600VAC output types
4,000Vrms optical isolation
1 Form A (SPST-NO)

Potter & Brumfield SSRM

45A-65A DIN mount Solid State Relay with integrated heat sink
44.5mm design
Inverse parallel SCR output
600VAC output type
4,000Vrms optical isolation
1 Form A (SPST-NO)



PCB mount not applicable.
Visit [TE.com](https://www.te.com) for more information



PCB mount not applicable.
Visit [TE.com](https://www.te.com) for more information



PCB mount not applicable.
Visit [TE.com](https://www.te.com) for more information

Typical Applications

Material handling
Trains
Construction equipment

Industrial machinery
HVAC
Building controls

Industrial machinery
HVAC
Building controls

Output Data

Load Voltage	200VDC	24 - 280VAC/48 - 660VAC	48 - 660VAC
Repetitive Blocking Voltage	NA	600VAC/1200VAC	1200VAC
Load Current Range	10 A/25 A/40 A	10A/20A/30A	45A/55A/65A
Leakage Current (Off-State)	12mA	5mA	1mA
On-State Voltage Drop (Max.)	2.83VDC	1.8V/1.6V	1.7V
Load Power Factor Rating	NA	0.5 - 1.0	0.5 - 1.0
Thermal Resistance, Junction to Case (R _{θJ-C}) (Max.)	0.7/0.7/0.5	-	-

Input Data (AC/DC)

Control Voltage Range VIN	3 - 32VDC	90 - 280VAC/3 - 32VDC	90 - 140VAC/4 - 32VDC
Must Operate Voltage VIN(OP) (Min.)	3.5VDC	90VAC/3VDC	90VAC/3VDC
Must release Voltage VIN(REL) (Min.)	1VDC	10VAC/1VDC	10VAC/1VDC
Input Current	30mA	7.5mA - 16mA/18 - 30mA	15mA/14 - 30mA

Dielectric Strength

Isolation:	1500VDC	4000Vrms	4000Vrms
------------	---------	----------	----------

Other Data

Dimensions	45x57.8x43.4mm	22.5x82.3x111.5mm	22.5x76.2x109.2mm
Operating Temperature	-30 to +80°C	-30 to +80°C	-40 to +80°C
Mounting	Panel	Din Rail	Din Rail
UL File No	E29244	E29244	E29244

Link to datasheet	POTTER & BRUMFIELD SSRDC	POTTER & BRUMFIELD SSRK	POTTER & BRUMFIELD SSRM
-------------------	--	---	---

1) Recommended minimum load indication for contact material: AU and gold plated; 1mA at 6VDC; AgNi0.15 and AgNi90/10; 10mA at 12VDC; AgCdO and AgSnO₂; 100mA at 12VDC. Please contact technical support for detailed technical data.

Solid State Relays

Relays, Contactors & Circuit Breakers

Key Features

Potter & Brumfield SSRA

2A Miniature, SIP Solid State Relay
 Inverse parallel SCR output
 2500Vrms optical isolation
 240VAC output
 1 Form A (SPST-NO)

Potter & Brumfield SSRC

5A SIP Solid State Relay
 Inverse parallel SCR output
 4000Vrms optical isolation
 1 Form A (SPST-NO)

Footprint

2) see footnote below

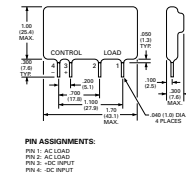
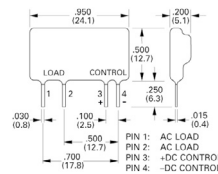

Typical Applications	Industrial machinery HVAC Building controls	Industrial machinery HVAC Building controls
Output Data		
Load Voltage	12 - 280VAC	12 - 280VAC/48 - 660VAC
Repetitive Blocking Voltage	600VAC	600VAC/1200VAC
Load Current Range	2A	5A
Leakage Current (Off-State)	0.1mA	0.1mA
On-State Voltage Drop (Max.)	1.5V	1.4V
Load Power Factor Rating	0.5 - 1.0	0.5 - 1.0
Thermal Resistance, Junction to Case (ROJ-C) (Max.)	-	-
Input Data (AC/DC)		
Control Voltage Range VIN	4-10VDC	3 - 15VDC
Must Operate Voltage VIN(OP) (Min.)	4VDC	4VDC
Must release Voltage VIN(REL) (Min.)	1VDC	1VDC
Input Current	15mA	15mA
Dielectric Strength		
Isolation:	2500Vrms	4000Vrms
Other Data		
Dimensions	24.1x5.1x12.7mm	43.1x7.6x25.4mm
Operating Temperature	-30 to + 80°C	-30 to + 80°C
Mounting	PCB	PCB
UL File No	E29244	E29244
Link to datasheet	POTTER & BRUMFIELD SSRA	POTTER & BRUMFIELD SSRC

1) Recommended minimum load indication for contact material: AU and gold plated: 1mA at 6VDC; AgNi0.15 and AgNi90/10: 10mA at 12VDC; AgCdO and AgSnO₂: 100mA at 12VDC. Please contact technical support for detailed technical data. 2) Footprint images are representative. For a complete selection, refer to the TE data sheet via the link above.

Solid State Relays

Relays, Contactors & Circuit Breakers

Key Features

Potter & Brumfield SSRF

25A SIP Solid State Relay with integrated heat sink
Inverse parallel SCR output
4000Vrms optical isolation
1 Form A (SPST-NO)

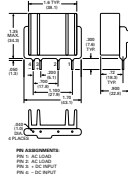

Potter & Brumfield IACM

Slim Solid State AC Input Module
Color coded by function - Yellow
4000Vrms optical isolation
Compatible with 2IO series mounting boards
1 Form A (SPST-NO)

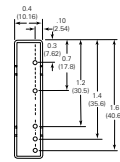

Footprint

2) see footnote below

Typical Applications

Industrial machinery
HVAC
Building controls

Industrial machinery
HVAC
Building controls

Output Data

Load Voltage	12 - 280VAC/48 - 660VAC	30VDC
Repetitive Blocking Voltage	600VAC/1200VAC	-
Load Current Range	10A (CC)/25A (FAC)	50mA
Leakage Current (Off-State)	0.1mA	10uA
On-State Voltage Drop (Max.)	1.6V	0.2VDC
Load Power Factor Rating	0.5 - 1.0	-
Thermal Resistance, Junction to Case (ROJ-C) (Max.)	-	-

Input Data (AC/DC)

Control Voltage Range VIN	3 - 15VDC	24VAC/120VAC/240VAC
Must Operate Voltage VIN(OP) (Min.)	4VDC	18VAC/90VAC/280VAC
Must release Voltage VIN(REL) (Min.)	1VDC	10VAC/60VAC/60VAC
Input Current	15mA	1-5mA

Dielectric Strength

Isolation:	4000Vrms	4000Vrms
------------	----------	----------

Other Data

Dimensions	43.1x22.8x34.3mm	43.5x10.3x25.5mm
Operating Temperature	-30 to + 80°C	-30 to 100°C
Mounting	PCB	PCB
UL File No	E29244	E29244

Link to datasheet

[POTTER & BRUMFIELD SSRF](#)

[POTTER & BRUMFIELD IACM](#)

1) Recommended minimum load indication for contact material: AU and gold plated: 1mA at 6VDC; AgNi0.15 and AgNi90/10: 10mA at 12VDC; AgCdO and AgSnO₂: 100mA at 12VDC. Please contact technical support for detailed technical data. 2) Footprint images are representative. For a complete selection, refer to the TE data sheet via the link above.

Solid State Relays

Relays, Contactors & Circuit Breakers

Key Features

Potter & Brumfield OACM

Slim Solid State AC Output Module
Color coded by function - black
4000Vrms optical isolation
Compatible with 2IO series mounting boards
1 Form A (SPST-NO)

Potter & Brumfield IDCM

Slim Solid State DC Input Module
Color coded by function - white
4000Vrms optical isolation
Compatible with 2IO series mounting boards
1 Form A (SPST-NO)

Potter & Brumfield ODCM

Slim Solid State AC Output Module
Color coded by function - red
4000Vrms optical isolation
Compatible with 2IO series mounting boards
1 Form A (SPST-NO)

Footprint

2) see footnote below

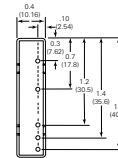
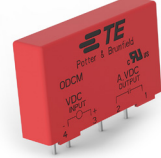
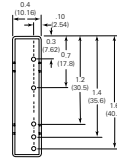
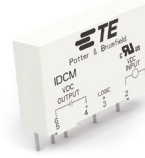
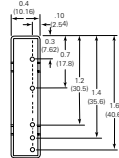

Typical Applications

Industrial machinery
HVAC
Building controls

Industrial machinery
HVAC
Building controls

Industrial machinery
HVAC
Building controls

Output Data

Load Voltage	24 - 280VAC	30VDC	60VDC
Repetitive Blocking Voltage	600VAC	-	-
Load Current Range	3A/5A	50mA	3A
Leakage Current (Off-State)	5mA	10uA	0.5mA
On-State Voltage Drop (Max.)	1.6VAC	0.2VDC	1.5VDC
Load Power Factor Rating	-	-	-
Thermal Resistance, Junction to Case (R0J-C) (Max.)	-	-	-

Input Data (AC/DC)

Control Voltage Range VIN	3 - 8VDC / 3 - 15VDC	3 - 32VDC/10 - 60VDC	5VDC/15VDC/24VDC
Must Operate Voltage VIN(OP) (Min.)	3VDC	3VDC/10VDC	3VDC/9VDC/18VDC
Must release Voltage VIN(REL) (Min.)	1VDC	1VDC/1VDC	1VDC
Input Current	8mA	10mA	20mA

Dielectric Strength

Isolation:	4000Vrms	4000Vrms	4000Vrms
------------	----------	----------	----------

Other Data

Dimensions	43.5x10.3x25.5mm	43.5x10.3x25.5mm	43.5x10.3x25.5mm
Operating Temperature	-30 to 100°C	-30 to 100°C	-30 to 100°C
Mounting	PCB	PCB	PCB
UL File No	E29244	E29244	E29244

Link to datasheet

[POTTER & BRUMFIELD OACM](#)

[POTTER & BRUMFIELD IDCM](#)

[POTTER & BRUMFIELD ODCM](#)

1) Recommended minimum load indication for contact material: AU and gold plated: 1mA at 6VDC; AgNi0.15 and AgNi90/10: 10mA at 12VDC; AgCdO and AgSnO₂: 100mA at 12VDC. Please contact technical support for detailed technical data. 2) Footprint images are representative. For a complete selection, refer to the TE data sheet via the link above.

Circuit Breakers

Relays, Contactors & Circuit Breakers

Key Features

Potter & Brumfield W28

Thermal Overload / Trip Free Operation
 Replaces slow blow glass cartridge fuse and holder
 Button provides visible trip indication
 Push-to-reset
 Snap-in mounting
 UL 1077, CSA, VDE, CCC (16A/20A not VDE)



PCB mount not applicable.
 Visit [TE.com](https://www.te.com) for more information

Potter & Brumfield W23/W31

Thermal Overload / Trip Free Operation
 Toggle or Push/Pull Actuation
 Cannot be reset against overload
 On/Off switching option
 UL 1077, CSA



PCB mount not applicable.
 Visit [TE.com](https://www.te.com) for more information

Typical Applications

HVAC (Transformers), General Aviation, Medical, Marine Power Supplies, Lighting, Surge Protection Audio, Pool and Spa, Appliances, Industrial Controls

Generators, General Aviation, Medical, Marine Power Supplies, Lighting, Surge Protection Audio, Pool and Spa, Appliances, Industrial Controls

Operational Data

Type	Thermal	Thermal
Number of Poles	1	1
Circuit function	Series trip	Series trip
Ambient temperature (max.)	-20 to +60 °C	-20 to +65°C
Terminal type	Standard quick connect .250in x .032in	#8-32 screw
Mounting	Snap-in	Thru-hole 3/8"-24 threaded bushing
Manual operation Actuator	Push-to-reset	Push/pull W23 and toggle W31
Dimension L*W*H	39.0 x 15.9 x 13.7mm	40.6x17.5x35.2mm

Electrical Data

Dielectric strength	1500Vrms	1500Vrms
Insulation Resistance		
Max Operating Voltages	32VDC 250VAC, 50/60Hz	50VDC 240VAC to (400Hz)
Rated current	0.5A to 20A	1A to 50A
Interrupt capacity	1,000 amps at 250VAC, 50/60 Hz. and 32VDC in accordance with UL standard 1077.	With 4X Max. Series Fuse Protection 0.5-50 amp models – 1000 amps at 240VAC. 30-50 amp models – 1000 amps at 50VDC. Without 4X Max. Series Fuse Protection 0.5-25 amp models – 2000 amps at 50VDC. 10-20 amp models – 2000 amps at 120VAC Continuously carry 100% of rating, may trip between 101% and 134% of rating at 25°C. Must trip at 135% in one hour.
Calibration	Will continuously carry 100% of rating. 3-20 amp models - may trip between 101% and 134%, but must trip at 135% of rating within one hour at +25°C. 0.25-2 amp models - may trip between 101% and 174%, but must trip at 175% of rating within one hour at +25°C.	
Resettable Overload Capacity	Six times rated current for 0.25 through 2 amp models. Ten times rated current for 3 through 20 amp models.	Ten times rated current.
Reset Time	180 seconds max. for 0.25 through 2 amp models. 5 to 30 seconds for 3 through 20 amp models.	

Accessories

Protective boot, push-on lockwasher

Hex nut, lockwasher, knurl nut

Link to datasheet

[POTTER & BRUMFIELD W28](#)

[POTTER & BRUMFIELD W23/W31](#)

1) Recommended minimum load indication for contact material: AU and gold plated: 1mA at 6VDC; AgNi015 and AgNi90/10: 10mA at 12VDC; AgCdO and AgSnO₂: 100mA at 12VDC. Please contact technical support for detailed technical data. 2) Footprint images are representative. For a complete selection, refer to the TE data sheet via the link above.

Circuit Breakers

Relays, Contactors & Circuit Breakers

Key Features

Potter & Brumfield W33

Thermal overload/trip free Operation
Optional indicator lamp
Optional auxiliary switch
Combines on/off switching and circuit protection in a single unit
UL 1077, CSA



PCB mount not applicable.
Visit [TE.com](https://www.te.com) for more information

Potter & Brumfield W51

Thermal overload/trip free operation
Rocker actuated with switch overload sensing
Optional indicator lamp
Combines power switching and circuit protection in a single unit
Compact design
PCB termination options
UL1077, cUL, VDE, CCC



PCB mount not applicable.
Visit [TE.com](https://www.te.com) for more information

Potter & Brumfield W54

Thermal overload/trip free operation
Push to reset
Visual trip indication
Multiple termination options
UL 1077, UL 1500, cUL, VDE, CCC, CSA. (>30A not UL1500 or CSA) (>20A not VDE)



PCB mount not applicable.
Visit [TE.com](https://www.te.com) for more information

Typical applications

Generators, General Aviation, Medical, Marine
Power Supplies, Lighting, Surge Protection
Audio, pool and spa, appliances, Industrial controls

Generators, General Aviation, Medical, Marine
Power Supplies, Lighting, Surge Protection
Audio, pool and spa, appliances, Industrial controls

Generators, general aviation, medical, marine
Power supplies, lighting, surge protection
Audio, pool and spa, appliances, Industrial controls

Operational Data

Type	Thermal	Thermal	Thermal
Number of Poles	1-2	1	1
Circuit function	Series trip both poles; series trip 1 pole/switch only 1 pole; switch only 2 poles	Series trip	Series trip
Ambient temperature (max.)	-20 to +65 °C	0°C to + 60 °C for 10-20A models 0°C to + 50 °C for 5-8A models	0 to 60 °C
Terminal type	Standard quick connect 250in x .032in and solder option	Standard quick connect 250in x .032in/solder option/PCB	Standard quick connect 250in x .032in and #8-32 screw 3/8"-24, M11-1.0, M12-1.0 threaded bushing
Mounting	Snap-in	Snap-in, PCB	
Manual operation Actuator	Rocker	Rocker	Push-to-reset
Dimension L*W*H	43.8 x 24.9 x 48.0mm	21.8 x 15.2 x 32.0mm	31.0 x 14.6 x 35.0mm (W54) 22.6 x 14.6 x 29.2mm (W57)

Electrical Data

Dielectric strength	2000Vrms	1500VAC	1500VAC
Insulation Resistance		100M Ω	100MΩ
Max Operating Voltages	50VDC 250VAC	50VDC 125/250VAC (model dependent)	50VDC 250VAC
Rated current	2A to 20A	5A to 20A	5A to 40A
Interrupt capacity	1000A at 50VDC, 250VAC/60Hz and 125/250VAC 400Hz; 1500A at 25/250VAC/60Hz	1,000 amps in accordance with UL standard 1077	1,000 amps in accordance with UL standard 1077
Calibration	Will continuously carry 100% of rating. May trip between 101% and 134%, but must trip at 135% of rating within one hour at +25°C 150% for 5-8A models	Will continuously carry 100% of rating. May trip between 101% and 134%, but must trip at 135% of rating within one hour at +25°C. 150% for 5-8A models	Will continuously carry 100% of rating. May trip between 101% and 134%, but must trip at 135% of rating within one hour at +25°C
Resettable OverloadCapacity	Ten times rated current	Ten times rated current. Switch Endurance Cycling: Typically 6,000 operations at 100% of rating	Ten times rated current.
Reset Time		60 Seconds	60 Seconds

Accessories

Protective boot, knurl nut, hex nut, lockwasher, nameplate

Link to datasheet

[POTTER & BRUMFIELD W33](#)

[POTTER & BRUMFIELD W51](#)

[POTTER & BRUMFIELD W54](#)

1) Recommended minimum load indication for contact material: AU and gold plated: 1mA at 6VDC; AgNi0.15 and AgNi90/10: 10mA at 12VDC; AgCdO and AgSnO₂: 100mA at 12VDC. Please contact technical support for detailed technical data.

Circuit Breakers

Relays, Contactors & Circuit Breakers

Key Features

Potter & Brumfield W57

Thermal overload/trip free operation
Push to reset
Compact design
Cannot be manually tripped
PCB termination options
UL 1077, UL 1500, cUL, VDE, CCC.
(3A,4A,20A no VDE)



PCB mount not applicable.
Visit [TE.com](https://www.te.com) for more information

Potter & Brumfield W58

Thermal overload/trip free operation
Push to reset
Cannot be manually tripped
Visual trip indication
UL 1077, UL 1500, CSA. (30A not UL or CSA)



PCB mount not applicable.
Visit [TE.com](https://www.te.com) for more information

Potter & Brumfield W6/W9

Magnetic hydraulic actuation/trip-free operation
Several delay curve options
Fungus and moisture resistant
UL 1077, UL 1500, CSA, VDE

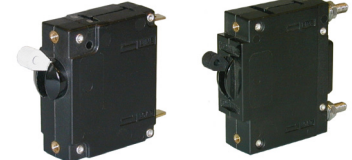

PCB mount not applicable.
Visit [TE.com](https://www.te.com) for more information

Applications

Generators, general aviation, medical, marine
Power supplies, lighting, surge protection
Audio, pool and spa, appliances, Industrial controls

Generators, general aviation, medical, marine
Power supplies, lighting, surge protection
Audio, pool and spa, appliances, Industrial controls

HVAC (transformers), general aviation, medical, marine
Power supplies, lighting, surge protection
Audio, pool and spa, appliances, Industrial controls

Operational Data

Type	Thermal	Thermal	Magnetic/hydraulic
Number of Poles	1	1	1-4
Circuit function	Series trip	Series trip	Series trip
Ambient temperature (max.)	0 to 60°C	-25 to 65°C	-40 to +85 °C
Terminal type	Standard quick connect .250in x .032in and #8-32 screw and PCB option	Standard quick connect .250in x .032in and #8-32 screw	W6-Standard Quick Connect .250in x .032in and #8-32 or #10/32 screw. W9- #10/32 stud terminations 6-32, M3 tapped holes
Mounting	3/8"-24, M11-1.0, M12-1.0 threaded bushing	7/16"-28, 15/32"-32, 3/8"-24 threaded bushing"	
Manual operation Actuator	Push-to-reset	Push-to-reset	Toggle
Dimension L*W*H	31.0 x 14.6 x 35.0mm (W54) 22.6 x 14.6 x 29.2mm (W57)	34.9 x 16.8 x 34.9mm	41.7 x 19.0 x 50.8mm (W6 per pole) 46.9 x 19.0 x 63.5mm (W9 per pole)

Electrical Data

Dielectric strength	1500VAC	1500Vrms	50/60 Hz, 1500V: DC, 1100V
Insulation Resistance			100 megohms at 500VDC
Max Operating Voltages	50VDC, 250VAC 50/60 Hz	50VDC, 250VAC	65VDC, 277VAC, 480VAC - 3Ø wye
Rated current	3A to 20A	0.5A to 30A	0.20A to 50A
Interrupt capacity	1000 amps in accordance with UL standard 1077	2000 amps at 50VDC (0.5 - 30 amp models) 1000 amps at 250VAC (0.5 - 30amp models). Note: 30 amp model not UL or CSA	up to 5000A with UL 1077, CSA, VDE. Up to 3000A for UL 1500
Calibration	Will continuously carry 100% of rating. May trip between 101% and 134%, but must trip at 135% of rating within one hour at +25°C	Breaker will continuously carry 100% of rated load. It may trip between 101% and 145% of rated load, but must trip at 145% at 25°C	Breakers will hold 100% rated current. May trip between 101% and 124% rated load (134% for AC/DC units) Must trip at 125% rated load (135% for AC/DC units)
Resettable Overload Capacity	Ten times rated current	Ten times rated current	Ten times rated current
Reset Time	60 Seconds		60 Seconds

Accessories

Protective boot, knurl nut, hex nut, lockwasher, nameplate

Protective boot, knurl nut, hex nut, lockwasher

Toggle guard (W6 only)

Link to datasheet

[POTTER & BRUMFIELD W57](#)

[POTTER & BRUMFIELD W58](#)

[POTTER & BRUMFIELD W6/W9](#)

1) Recommended minimum load indication for contact material: AU and gold plated: 1mA at 6VDC; AgNi0.15 and AgNi90/10: 10mA at 12VDC; AgCdO and AgSnO₂: 100mA at 12VDC. Please contact technical support for detailed technical data.

Transformers

Relays, Contactors & Circuit Breakers

Key Features

4000 SERIES WIRE LEAD CLASS II CONTROL TRANSFORMERS

5VA to 75VA
 UL 5085-3, formerly UL 1585
 Inherently/non-inherently energy limited
 Wire lead terminations
 Custom specification/design available

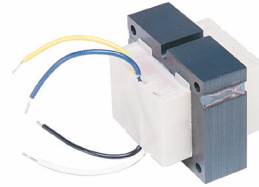

Visit TE.com for more information

4000 SERIES QUICK CONNECT CLASS II CONTROL TRANSFORMERS

5VA to 75VA
 UL 5085-3, formerly UL 1585
 Inherently/non-inherently energy limited
 Quick connect terminals
 Custom specification/design available

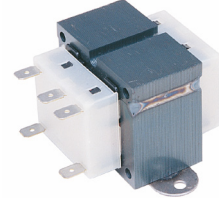

Visit TE.com for more information

Typical Applications

HVAC
 Industrial and residential
 Motor control

HVAC
 Industrial and residential
 Motor control

Specifications

Primary Voltage- AC	120, 208, 240, 277, 380, 415, 480, 575	120, 208, 240, 277, 380, 415, 480, 575
Secondary Voltage- DC	12 or 24	12 or 24
Insulation Class	UL Class B (130°C)	UL Class B (130°C)
Wire Size	Standard 18 AWG stranded, 12in	N/A
QC size	N/A	standard .250in x .032in
Terminations	Same side - opposite side	Type BB Same side Type AB Opposite side Type AE Laydown
Frequency	50/60 Hz	50/60 Hz
Mounting Options	Type K Foot Mount Type G Panel Mount Plate Mount	Type K Foot Mount Type G Panel Mount Plate Mount

Other Data

Secondary Fusing Requirement	60VA-75VA non-inherently energy limited	Internal fuse or integral circuit breaker 75VA standard models come with integral circuit breaker
Shielding	Internal fuse or integral circuit breaker	
Dielectric Strength	75VA standard models come with integral circuit breaker	

Link to datasheet

[4000 SERIES WIRE LEAD CLASS II CONTROL TRANSFORMERS](#)

[4000 SERIES QUICK CONNECT CLASS II CONTROL TRANSFORMERS](#)

1) Recommended minimum load indication for contact material: AU and gold plated: 1mA at 6VDC; AgNi0.15 and AgNi90/10: 10mA at 12VDC; AgCdO and AgSnO₂: 100mA at 12VDC. Please contact technical support for detailed technical data.

Transformers

Relays, Contactors & Circuit Breakers

Key Features

4700 SERIES GENERAL PURPOSE POWER TRANSFORMERS

60VA to 150VA
 UL 5085-1,-2 formerly UL 50
 Non-fused
 Wire leads or quick connects
 Custom specification/design available

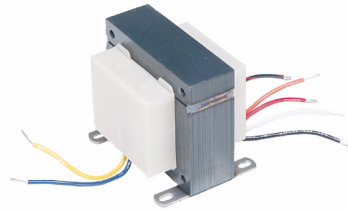

Visit [TE.com](https://www.te.com) for more information

4900 SERIES PRINTED CIRCUIT MOUNT POWER TRANSFORMERS

1.1VA to 36VA
 UL 5085-1,-2 formerly UL 506
 Drop in replacement
 Split bobbin design
 Signal or dual primary voltage
 Custom specification/design available



Visit [TE.com](https://www.te.com) for more information

Applications	HVAC Industrial Motor control	Industrial controls, garage door openers small power supplies, control boards lighting/monitoring controls, vending machines
Specifications		
Primary Voltage- AC	120, 208, 240, 230, 277, 460, 480, 575	Single 115VAC, 6-pin Dual 115/230VAC, 8-pin
Secondary Voltage- DC	24	Series 10-120VCT Parallel 6-60VAC
Insulation Class	UL Class B (130°C)	UL Class B (130°C)
Wire Size	Standard 18 AWG stranded, 12in	N/A
QC size	Standard .250in x .032in	N/A
Terminations	Type BB same side Type AB opposite side	PCB through hole design
Frequency	50/60 Hz	50/60 Hz
Mounting Options	Type K foot mount	PCB through hole design
Other Data		
Secondary Fusing Requirement		
Shielding		Electrostatic shielding not required due to split bobbin
Dielectric Strength		1500Vrms
Link to datasheet	4700 SERIES GENERAL PURPOSE POWER TRANSFORMERS	4900 SERIES PRINTED CIRCUIT MOUNT POWER TRANSFORMERS

1) Recommended minimum load indication for contact material: AU and gold plated: 1mA at 6VDC; AgNi0.15 and AgNi90/10: 10mA at 12VDC; AgCdO and AgSnO₂: 100mA at 12VDC. Please contact technical support for detailed technical data.

