



Wi-Fi 6/ 6E TRIPLE BAND EMBEDDED ANTENNA

**Part Numbers: 2118909-1, 2118909-2
2118909-4, 2118909-5
2118909-6, 2118909-8
1-2118909-1/-2/-3/-4/-5/-6/-7/-8**

FEATURES & BENEFITS

- WiFi 6, also including WiFi 6E new 6GHz band, Bluetooth, ZigBee
- Adhesive backing on the PCB simplifies mounting within the device
- Global Frequency coverage
- PCB antenna assembly
- Different cable length and connector options available

SPECIFICATIONS (Shown as 2118909-1 : Others can vary with different cable lengths.)

Frequency Range (MHz)	2400-2500	5150-5875	5925-7125
VSWR	< 1.9:1	< 1.8:1	< 2.2:1
Average Efficiency	80%	69%	66%
Peak Gain	4.3dBi	4.3dBi	5.0dBi
Average Gain	-1.0dBi	-1.6dBi	-1.9dBi
Power Handling	10 Watt cw		
Feed Point Impedance	50 ohms unbalanced		
Polarization	Linear		
Size	40.0 mm x 8.0 mm x 1.0 mm		
Weight	< 2.3 g		
Mounting	Adhesive Tape		
Mating Connectors	MHF and MHF4L-type Refer to page 5		
Cable (Coaxial)	1.13mm Dia. Refer to page 5		
Operating Temperature	-40 to +85°C		
Storage Temperature	-40 to +85°C		
Hazardous Materials	A certificate of conformance is available from the product page on TE website.		

RF DATA (Shown as 2118909-1 : Others can vary with different cable lengths.)

VSWR

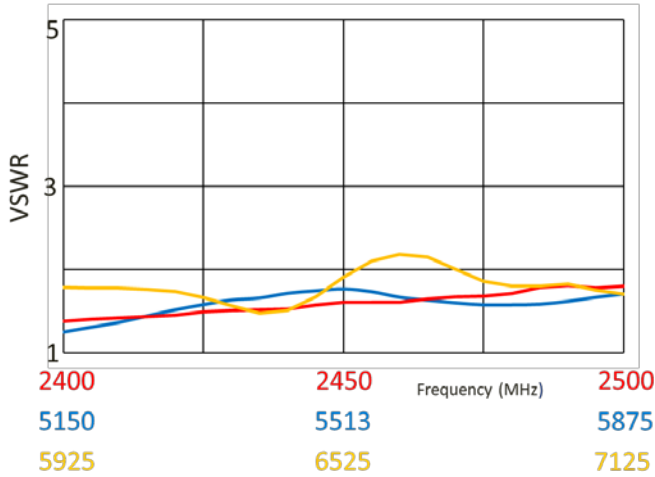

Return Loss

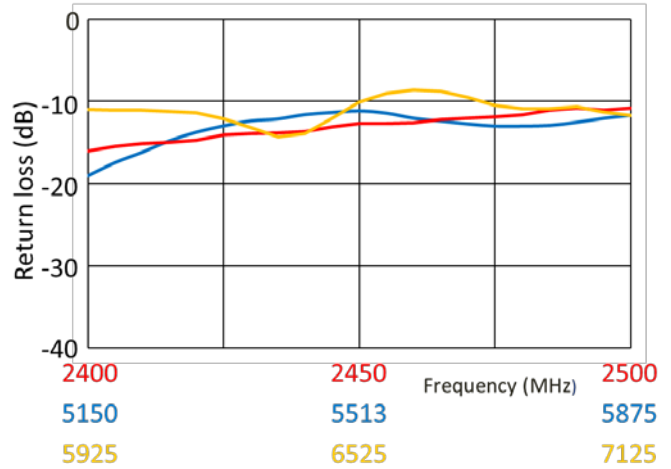

Efficiency

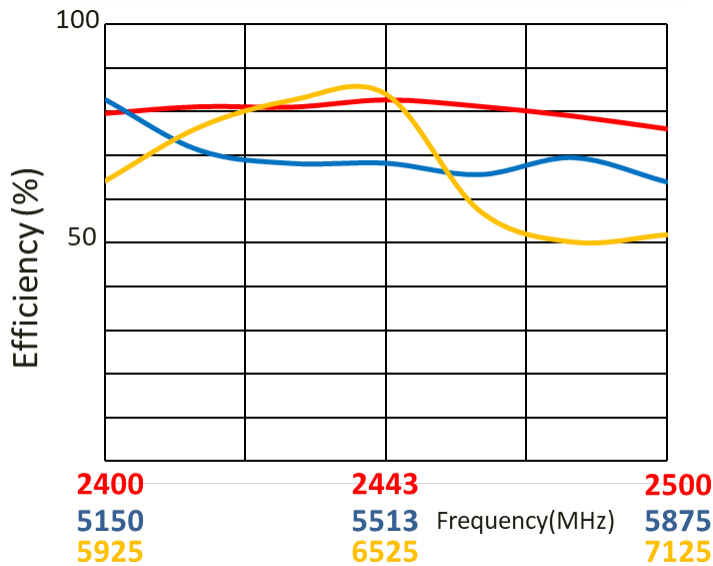

Data measured in free space and on plastic device enclosure

RADIATION PATTERN

(Shown as 2118909-1 : Others can vary with different cable lengths.)

Test setup

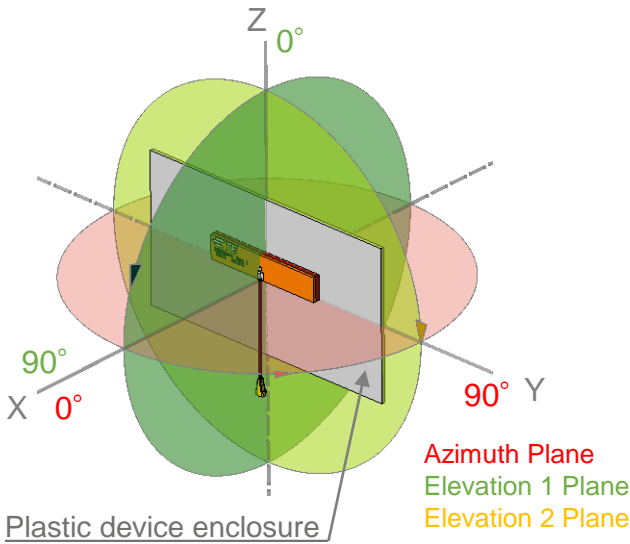

Azimuth

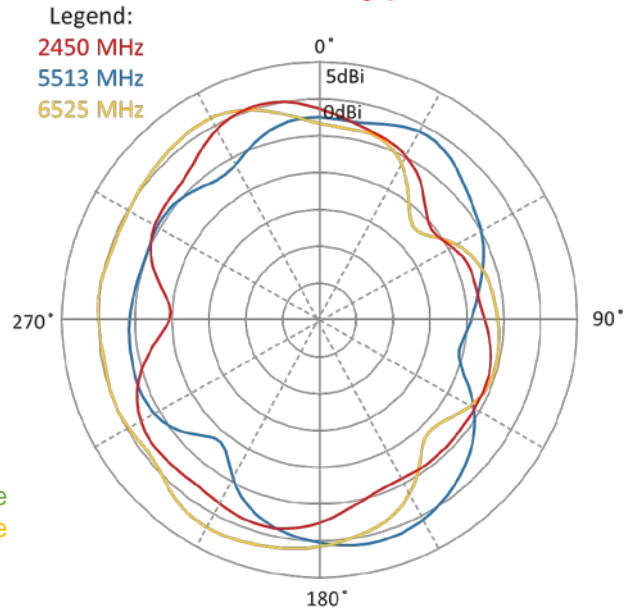

Elevation 1

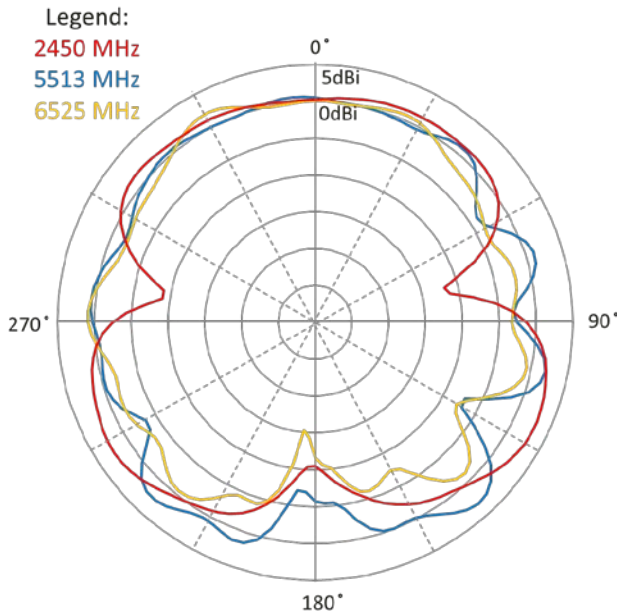

Elevation 2

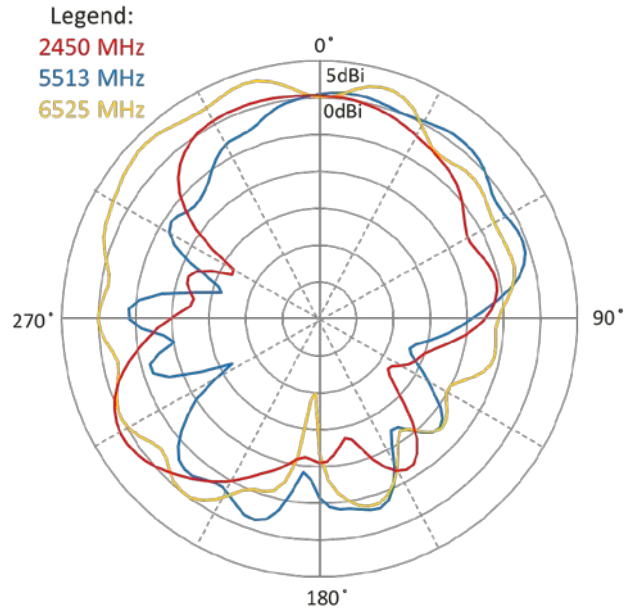

Data measured in free space and on plastic device enclosure

KEEP OUT AREA

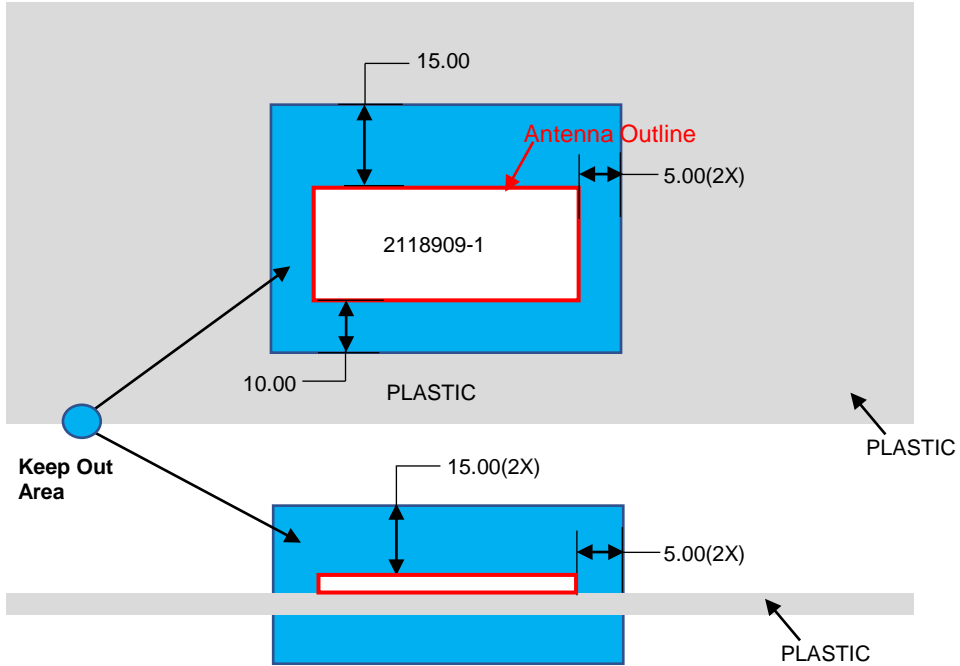

- NOTES: 1. Antenna designed to be mounted on plastic cover.
 2. Area in blue above indicates Keep Out Area.
 3. For more information please call TE.

Dimensions: mm
 Diagram is not to scale

DIMENSIONS

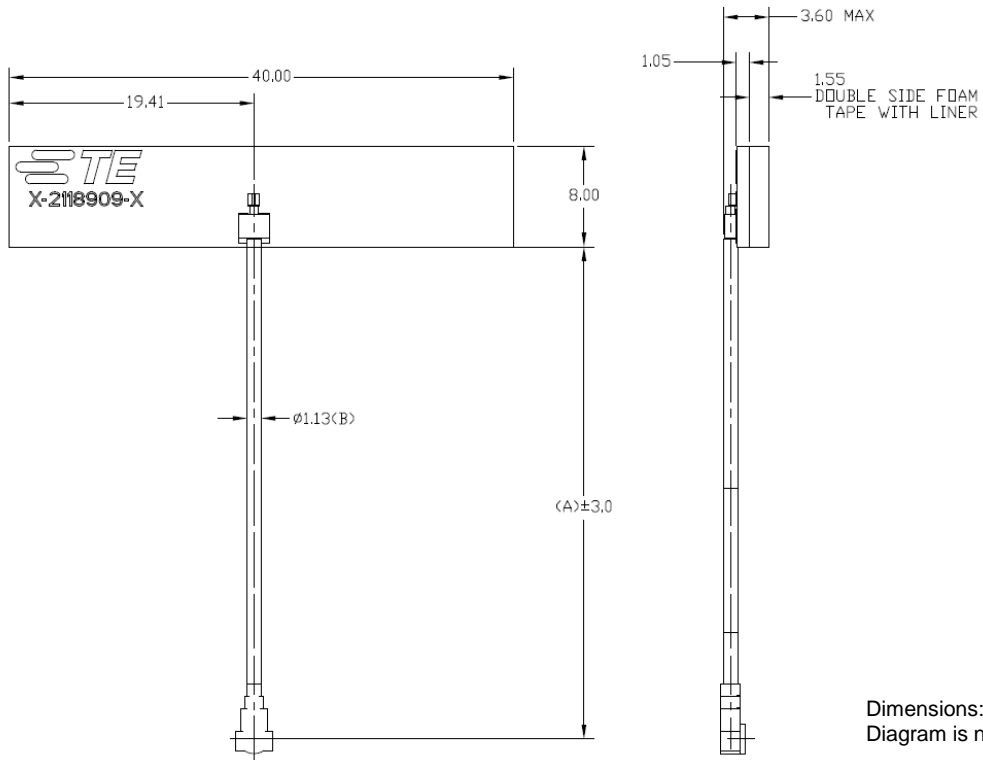

Dimensions: mm
 Diagram is not to scale

MATING COMPONENTS TO PART NUMBERS AND DIMENSIONS

2118909-1	120.0	3.048	1.13	MHF-TYPE PLUG	RECEPTACLE (TE PN: 2337019-1)	
2118909-2	273.0	6.934	1.13	MHF-TYPE PLUG	RECEPTACLE (TE PN: 2337019-1)	
2118909-8	64.15	1.629	1.13	MHF-TYPE PLUG	RECEPTACLE (TE PN: 2337019-1)	
2118909-4	120.0	3.048	1.13	MHF4L-TYPE PLUG	RECEPTACLE (TE PN: 2334884-1)	
2118909-5	225.0	5.715	1.13	MHF4L-TYPE PLUG	RECEPTACLE (TE PN: 2334884-1)	
2118909-6	375.0	9.525	1.13	MHF4L-TYPE PLUG	RECEPTACLE (TE PN: 2334884-1)	
PART NUMBER	MM	INCH	MM	CONNECTOR TYPE (ON CABLE)	PART NUMBER	IMAGE
	CABLE LENGTH(A)		CABLE O.D(B)		MATING COMPONENTS	

1-2118909-1	50.0	1.968	1.13	MHF-TYPE PLUG	RECEPTACLE (TE PN: 2337019-1)	
1-2118909-2	100.0	3.937	1.13	MHF-TYPE PLUG	RECEPTACLE (TE PN: 2337019-1)	
1-2118909-3	150.0	5.905	1.13	MHF-TYPE PLUG	RECEPTACLE (TE PN: 2337019-1)	
1-2118909-4	200.0	7.784	1.13	MHF-TYPE PLUG	RECEPTACLE (TE PN: 2337019-1)	
1-2118909-5	50.0	1.968	1.13	MHF4L-TYPE PLUG	RECEPTACLE (TE PN: 2334884-1)	
1-2118909-6	100.0	3.937	1.13	MHF4L-TYPE PLUG	RECEPTACLE (TE PN: 2334884-1)	
1-2118909-7	150.0	5.905	1.13	MHF4L-TYPE PLUG	RECEPTACLE (TE PN: 2334884-1)	
1-2118909-8	200.0	7.784	1.13	MHF4L-TYPE PLUG	RECEPTACLE (TE PN: 2334884-1)	
PART NUMBER	MM	INCH	MM	CONNECTOR TYPE (ON CABLE)	PART NUMBER	IMAGE
	CABLE LENGTH(A)		CABLE O.D(B)		MATING COMPONENTS	

PACKAGING

