

## 1.5KE-G Series

**Breakdown Voltage: 6.8 to 600 Volts**

**Peak Pulse Power: 1500 Watts**

**RoHS Device**

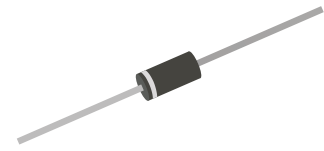

### Features

- Glass passivated chip.
- 1500W peak pulse power capability with a 10/1000 $\mu$ s waveform, repetitive rate (duty cycle):0.01%
- Low leakage.
- Uni and Bidirectional unit.
- Excellent clamping capability.
- Very fast response time.
- UL recognized file # E349157  Range: 1.5KE6.8(C)A thru. 1.5KE120(C)A

### Mechanical Data

- Case: Molded plastic, DO-201
- Epoxy: UL 94V-0 rate flame retardant
- Lead: Solderable per MIL-STD-202, method 208 guaranteed.
- Polarity: Color band denotes cathode end except bipolar.
- Mounting position: Any
- Weight: 0.844 grams(approx.).

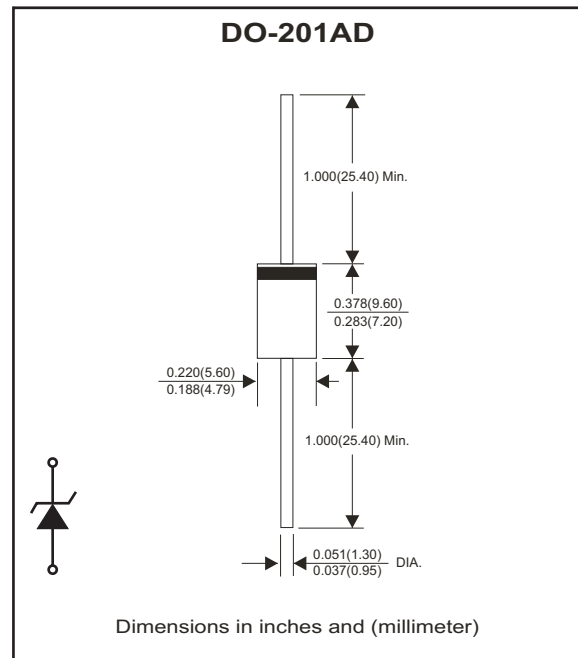

### Maximum Ratings (TA=25°C unless otherwise noted)

Parameter	Symbol	Value	Unit
Peak power dissipation with a 10/1000 $\mu$ s waveform (Note 1)	PPP	1500	W
Peak pulse current with a 10/1000 $\mu$ s waveform (Note 1)	I <sub>PP</sub>	See Next Table	A
Power dissipation on infinite heatsink at T <sub>L</sub> =75°C	P <sub>D</sub>	6.5	W
Peak forward surge current, 8.3ms single half sine-wave unidirectional only (JEDEC method) (Note 2)	I <sub>FSM</sub>	200	A
Maximum instantaneous forward voltage at 100 A for unidirectional only (Note 3)	V <sub>F</sub>	3.5/5.0	V
Operating junction and storage temperature range	T <sub>J</sub> , T <sub>STG</sub>	-55 to +150	°C

NTOES:

- (1) Non-repetitive current pulse, per fig.5 and derated above TA=25°C per fig.1
- (2) Measured on 8.3ms single half sine-wave or equivalent square wave, duty cycle=4 pulses per minute maximum
- (3) V<sub>F</sub><3.5V for devices of V<sub>BR</sub><200V and V<sub>F</sub><5.0V for devices of V<sub>BR</sub>>201V

Company reserves the right to improve product design , functions and reliability without notice.

REV:E

## RATING AND CHARACTERISTIC CURVES (1.5KE6.8-G Thru. 1.5KE600-G)

Fig.1 - Pulse Derating Curve



Fig.2 - Max. Non-repetitive Surge Current

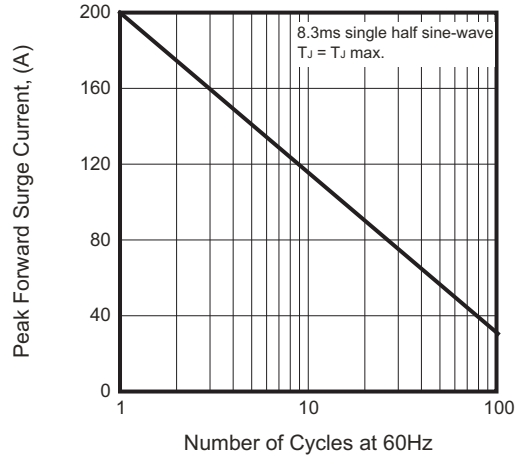

Fig.3 - Steady State Power Derating Curve

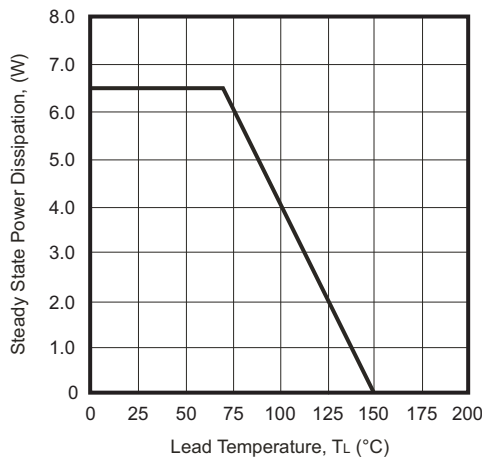

Fig.4 - Peak Pulse Power Rating Curve

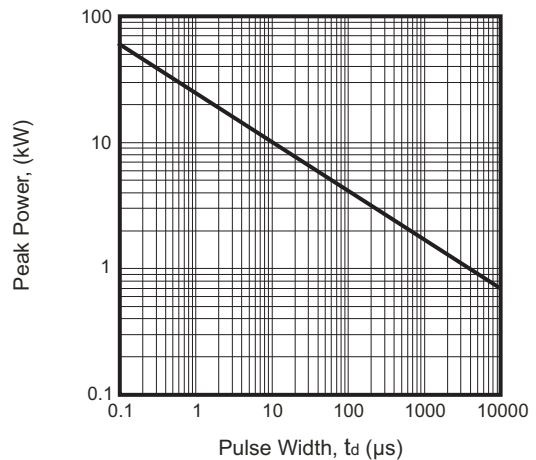

Fig.5 - Pulse Waveform

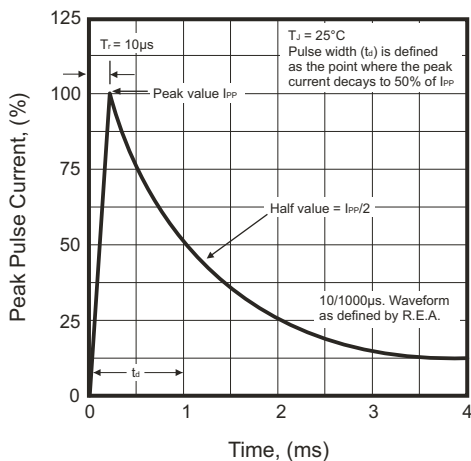
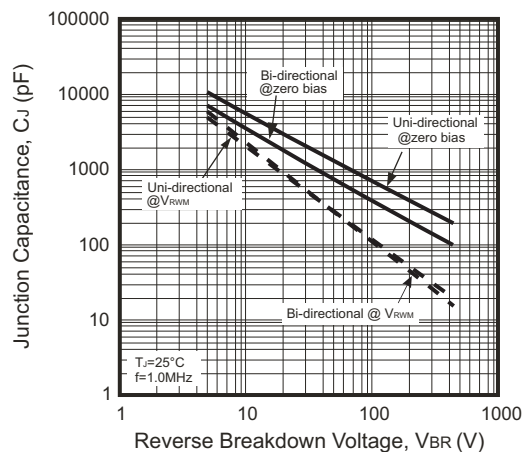

Fig.6 - Typical Junction Capacitance



Company reserves the right to improve product design, functions and reliability without notice.

# 1500W Transient Voltage Suppressor



## Electrical Characteristics (1.5KE6.8-G Thru. 1.5KE600-G)

Part No.	Breakdown voltage VBR @ IT			Maximum Reverse Leakage @VRWM IR (uA)	Working Peak Reverse Voltage VRWM (V)	Maximum Reverse Surge Current IPP (A)	Maximum Clamping Voltage @IPP Vc (V)	Marking Code	
	Min. (V)	Max. (V)	IT (mA)					UNI	BI
1.5KE6.8(C)A-G	6.46	7.14	10	1000	5.8	142.86	10.5	1.5KE6.8A	1.5KE6.8CA
1.5KE7.5(C)A-G	7.13	7.88	10	500	6.4	132.74	11.3	1.5KE7.5A	1.5KE7.5CA
1.5KE8.2(C)A-G	7.79	8.61	10	200	7.0	123.97	12.1	1.5KE8.2A	1.5KE8.2CA
1.5KE9.1(C)A-G	8.65	9.56	1.0	50	7.8	111.94	13.4	1.5KE9.1A	1.5KE9.1CA
1.5KE10(C)A-G	9.50	10.50	1.0	10	8.6	103.45	14.5	1.5KE10A	1.5KE10CA
1.5KE11(C)A-G	10.45	11.55	1.0	5.0	9.4	96.15	15.6	1.5KE11A	1.5KE11CA
1.5KE12(C)A-G	11.40	12.60	1.0	5.0	10.2	89.82	16.7	1.5KE12A	1.5KE12CA
1.5KE13(C)A-G	12.35	13.65	1.0	1.0	11.1	82.42	18.2	1.5KE13A	1.5KE13CA
1.5KE15(C)A-G	14.25	15.75	1.0	1.0	12.8	70.75	21.2	1.5KE15A	1.5KE15CA
1.5KE16(C)A-G	15.20	16.80	1.0	1.0	13.6	66.67	22.5	1.5KE16A	1.5KE16CA
1.5KE18(C)A-G	17.10	18.90	1.0	1.0	15.3	59.52	25.2	1.5KE18A	1.5KE18CA
1.5KE20(C)A-G	19.00	21.00	1.0	1.0	17.1	54.15	27.7	1.5KE20A	1.5KE20CA
1.5KE22(C)A-G	20.90	23.10	1.0	1.0	18.8	49.02	30.6	1.5KE22A	1.5KE22CA
1.5KE24(C)A-G	22.80	25.20	1.0	1.0	20.5	45.18	33.2	1.5KE24A	1.5KE24CA
1.5KE27(C)A-G	25.65	28.35	1.0	1.0	23.1	40.00	37.5	1.5KE27A	1.5KE27CA
1.5KE30(C)A-G	28.50	31.50	1.0	1.0	25.6	36.23	41.4	1.5KE30A	1.5KE30CA
1.5KE33(C)A-G	31.35	34.65	1.0	1.0	28.2	32.82	45.7	1.5KE33A	1.5KE33CA
1.5KE36(C)A-G	34.20	37.80	1.0	1.0	30.8	30.06	49.9	1.5KE36A	1.5KE36CA
1.5KE39(C)A-G	37.05	40.95	1.0	1.0	33.3	27.83	53.9	1.5KE39A	1.5KE39CA
1.5KE43(C)A-G	40.85	45.15	1.0	1.0	36.8	25.30	59.3	1.5KE43A	1.5KE43CA
1.5KE47(C)A-G	44.65	49.35	1.0	1.0	40.2	23.15	64.8	1.5KE47A	1.5KE47CA
1.5KE51(C)A-G	48.45	53.55	1.0	1.0	43.6	21.40	70.1	1.5KE51A	1.5KE51CA
1.5KE56(C)A-G	53.20	58.80	1.0	1.0	47.8	19.48	77.0	1.5KE56A	1.5KE56CA
1.5KE62(C)A-G	58.90	65.10	1.0	1.0	53.0	17.65	85.0	1.5KE62A	1.5KE62CA
1.5KE68(C)A-G	64.60	71.40	1.0	1.0	58.1	16.30	92.0	1.5KE68A	1.5KE68CA
1.5KE75(C)A-G	71.25	78.75	1.0	1.0	64.1	14.56	103.0	1.5KE75A	1.5KE75CA
1.5KE82(C)A-G	77.90	86.10	1.0	1.0	70.1	13.27	113.0	1.5KE82A	1.5KE82CA
1.5KE91(C)A-G	86.45	95.55	1.0	1.0	77.8	12.00	125.0	1.5KE91A	1.5KE91CA
1.5KE100(C)A-G	95.00	105.00	1.0	1.0	85.5	10.95	137.0	1.5KE100A	1.5KE100CA
1.5KE110(C)A-G	104.50	115.50	1.0	1.0	94.0	9.87	152.0	1.5KE110A	1.5KE110CA
1.5KE120(C)A-G	114.00	126.00	1.0	1.0	102.0	9.09	165.0	1.5KE120A	1.5KE120CA
1.5KE130(C)A-G	123.50	136.50	1.0	1.0	111.0	8.38	179.0	1.5KE130A	1.5KE130CA
1.5KE150(C)A-G	142.50	157.50	1.0	1.0	128.0	7.25	207.0	1.5KE150A	1.5KE150CA
1.5KE160(C)A-G	152.00	168.00	1.0	1.0	136.0	6.85	219.0	1.5KE160A	1.5KE160CA
1.5KE170(C)A-G	161.50	178.50	1.0	1.0	145.0	6.41	234.0	1.5KE170A	1.5KE170CA
1.5KE180(C)A-G	171.00	189.00	1.0	1.0	154.0	6.10	246.0	1.5KE180A	1.5KE180CA
1.5KE200(C)A-G	190.00	210.00	1.0	1.0	171.0	5.47	274.0	1.5KE200A	1.5KE200CA
1.5KE220(C)A-G	209.00	231.00	1.0	1.0	185.0	4.57	328.0	1.5KE220A	1.5KE220CA
1.5KE250(C)A-G	237.50	262.50	1.0	1.0	214.0	4.36	344.0	1.5KE250A	1.5KE250CA
1.5KE300(C)A-G	285.00	315.00	1.0	1.0	256.0	3.62	414.0	1.5KE300A	1.5KE300CA
1.5KE350(C)A-G	332.50	367.50	1.0	1.0	299.3	3.11	482.0	1.5KE350A	1.5KE350CA
1.5KE380(C)A-G	361.00	399.00	1.0	1.0	324.9	2.86	524.4	1.5KE380A	1.5KE380CA
1.5KE400(C)A-G	380.00	420.00	1.0	1.0	342.0	2.72	548.0	1.5KE400A	1.5KE400CA
1.5KE440(C)A-G	418.00	462.00	1.0	1.0	376.2	2.47	602.0	1.5KE440A	1.5KE440CA
1.5KE500(C)A-G	475.00	525.00	1.0	1.0	427.5	2.17	690.0	1.5KE500A	1.5KE500CA
1.5KE520(C)A-G	494.00	546.00	1.0	1.0	444.6	2.09	717.6	1.5KE520A	1.5KE520CA
1.5KE550(C)A-G	522.50	577.50	1.0	1.0	470.3	1.98	759.0	1.5KE550A	1.5KE550CA
1.5KE600(C)A-G	570.00	630.00	1.0	1.0	513.0	1.81	828.0	1.5KE600A	1.5KE600CA

- Note: 1) Suffix A denotes 5% tolerance devices.  
 2) Add suffix "C" or "CA" after part number to specify Bi-directional devices.  
 3) For Bi-Directional devices having VR of 10 volts and under, the IR limit is double.

Company reserves the right to improve product design , functions and reliability without notice.

## Taping Specification For Axial Lead Diodes

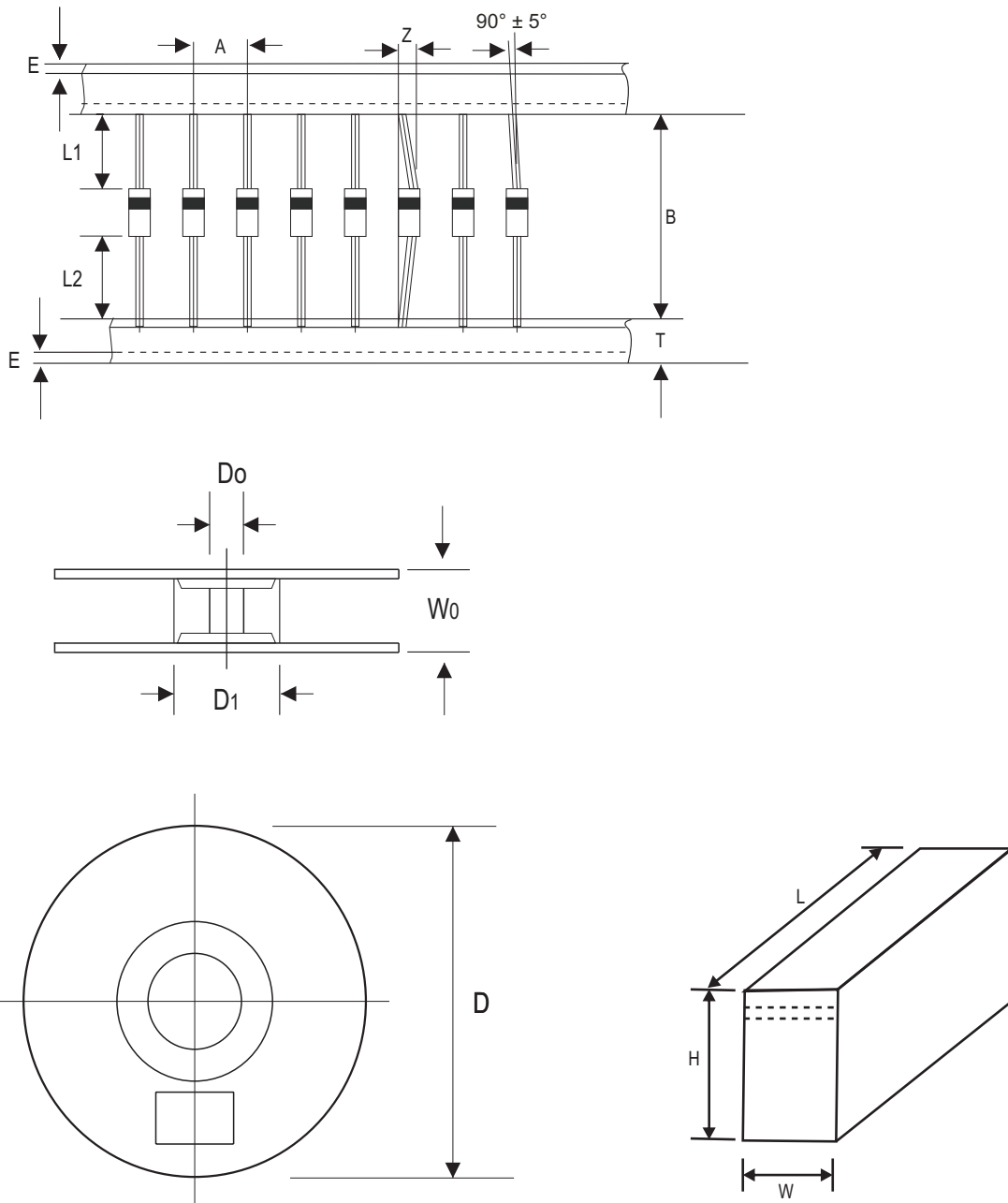

DO-201	SYMBOL	A	B	Z	T	E	L1-L2
	(mm)	$10.00 \pm 0.50$	$52.40 \pm 1.50$	1.60 (max)	$6.00 \pm 0.40$	3.00 (max)	1.00 (max)
	(inch)	$0.394 \pm 0.020$	$2.063 \pm 0.059$	0.063 (max)	$0.236 \pm 0.016$	0.118 (max)	0.039 (max)

DO-201	SYMBOL	D1	D0	D	W0	L	W	H
	(mm)	$85.70 \pm 0.30$	$16.60 \pm 0.40$	330.00	$72.00 \pm 3.00$	$260 \pm 5.00$	$75 \pm 5.00$	$145 \pm 5.00$
	(inch)	$3.374 \pm 0.012$	$0.654 \pm 0.016$	13.000	$2.835 \pm 0.118$	$10.236 \pm 0.197$	$2.953 \pm 0.197$	$5.709 \pm 0.197$

Company reserves the right to improve product design, functions and reliability without notice.