



1.5KE SERIES

GLASS PASSIVATED JUNCTION TRANSIENT VOLTAGE SUPPRESSOR PEAK PULSE POWER 1500 Watt

BREAKDOWN VOLTAGE

6.8 to 440 Volt

Recongized File # E210467 (1.5KE6.8~1.5KE300CA)

FEATURES

- Plastic package has Underwriters Laboratory Flammability Classification 94V-O
- Glass passivated chip junction in DO-201AE package
- 1500W surge capability at 1ms
- Excellent clamping capability
- Low zener impedance
- Fast response time: typically less than 1ps from 0 volts to BV min
- High temperature soldering guaranteed: 260°C/10 seconds/0.375" (9.5mm) lead length/5lbs. (2.3kg) tension
- ESD IEC-61000-4-2 Air \pm 30kV, Contact \pm 30kV
- Lead free in ccompliance with EU RoHS 2.0

MECHANICAL DATA

- Case: JEDEC DO-201AE molded plastic
- Terminals: Axial leads, solderable per MIL-STD-750, Method 2026
- Polarity: Color band denotes cathode end
- Approx. Weight: 0.04 ounce, 1.12 gram

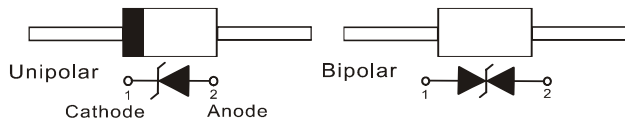

DO-201AE

Unit : inch(mm)

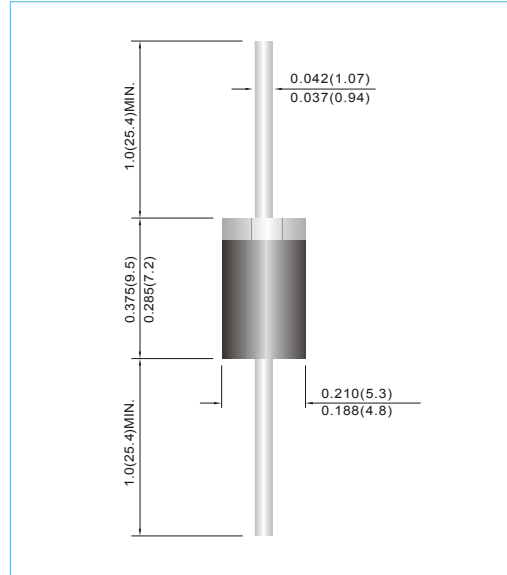

DEVICES FOR BIPOLAR APPLICATIONS

For Bidirectional use C or CA Suffix for types 1.5KE6.8 thru types 1.5KE440.
Electrical characteristics apply in both directions.

MAXIMUM RATINGS AND CHARACTERISTICS

Rating at 25°C ambient temperature unless otherwise specified.

Rating	Symbol	Value	Units
Peak Power Dissipation at $T_A=25^\circ\text{C}$, $t_p=1\text{ms}$ (Notes 1)	P_{PP}	1500	Watts
Typical Thermal Resistance Junction to Air Lead Lengths 0.375", (9.5mm) (Notes 2)	$R_{\theta JA}$	30	$^\circ\text{C} / \text{W}$
Peak Pulse Current on $t_p=10/1000\mu\text{s}$ waveform (Notes 1)	I_{PPM}	see Table	Amps
Peak Forward Surge Current, 8.3ms Single Half Sine-Wave Superimposed on Rated Load (Notes 3)	I_{FSM}	200	Amps
ESD IEC-61000-4-2 (Air) ESD IEC-61000-4-2 (Contact)	V_{ESD}	± 30 ± 30	kV
Operating Junction and Storage Temperature Range	T_J, T_{STG}	-65 to +175	$^\circ\text{C}$

NOTES :

1. Non-repetitive current pulse, per Fig. 3 and derated above $T_A=25^\circ\text{C}$ per Fig. 2.
2. Mounted on Copper Leaf area of $0.79 \text{ in}^2 (20\text{mm}^2)$.
3. 8.3ms single half sine-wave, duty cycle= 4 pulses per minutes maximum.
4. A transient suppressor is selected according to the working peak reverse voltage (V_{RWM}), which should be equal to or greater than the DC or continuous peak operating voltage level.



1.5KE SERIES

Part Number		Reverse Stand-off Voltage	Breakdown Voltage		Test Current	Reverse Leakage		Max. Clamp Voltage 10/1000µs	Peak Pulse Current 10/1000µs	Marking Code	
		V _{RWM} (Notes 4)	V _{BR} @ I _r		I _r	I _R @ V _{RWM}		V _C @ I _{PP}	I _{PP}		
			Min.	Max.		UNI	BI				
UNI	BI	V	V	V	mA	µA	µA	V	A	UNI	BI
1500W Transient Voltage Suppressor											
1.5KE6.8	1.5KE6.8C	5.5	6.12	7.48	10	1000	2000	10.8	139	1.5KE6.8	1.5KE6.8C
1.5KE6.8A	1.5KE6.8CA	5.8	6.45	7.14	10	1000	2000	10.5	143	1.5KE6.8A	1.5KE6.8CA
1.5KE7.5	1.5KE7.5C	6.05	6.75	8.25	10	500	1000	11.7	128	1.5KE7.5	1.5KE7.5C
1.5KE7.5A	1.5KE7.5CA	6.4	7.13	7.88	10	500	1000	11.3	132	1.5KE7.5A	1.5KE7.5CA
1.5KE8.2	1.5KE8.2C	6.63	7.38	9.02	10	200	400	12.5	120	1.5KE8.2	1.5KE8.2C
1.5KE8.2A	1.5KE8.2CA	7.02	7.79	8.61	10	200	400	12.1	124	1.5KE8.2A	1.5KE8.2CA
1.5KE9.1	1.5KE9.1C	7.37	8.19	10	1	50	100	13.8	109	1.5KE9.1	1.5KE9.1C
1.5KE9.1A	1.5KE9.1CA	7.78	8.65	9.5	1	50	100	13.4	112	1.5KE9.1A	1.5KE9.1CA
1.5KE10	1.5KE10C	8.1	9	11	1	10	20	15	100	1.5KE10	1.5KE10C
1.5KE10A	1.5KE10CA	8.55	9.5	10.5	1	10	20	14.5	103	1.5KE10A	1.5KE10CA
1.5KE11	1.5KE11C	8.92	9.9	12.1	1	5	10	16.2	93	1.5KE11	1.5KE11C
1.5KE11A	1.5KE11CA	9.4	10.5	11.6	1	5	10	15.6	96	1.5KE11A	1.5KE11CA
1.5KE12	1.5KE12C	9.72	10.8	13.2	1	5	5	17.3	87	1.5KE12	1.5KE12C
1.5KE12A	1.5KE12CA	10.2	11.4	12.6	1	5	5	16.7	90	1.5KE12A	1.5KE12CA
1.5KE13	1.5KE13C	10.5	11.7	14.3	1	1	1	19	79	1.5KE13	1.5KE13C
1.5KE13A	1.5KE13CA	11.1	12.4	13.7	1	1	1	18.2	82	1.5KE13A	1.5KE13CA
1.5KE15	1.5KE15C	12.1	13.5	16.5	1	1	1	22	68	1.5KE15	1.5KE15C
1.5KE15A	1.5KE15CA	12.8	14.3	15.8	1	1	1	21.2	71	1.5KE15A	1.5KE15CA
1.5KE16	1.5KE16C	12.9	14.4	17.6	1	1	1	23.5	64	1.5KE16	1.5KE16C
1.5KE16A	1.5KE16CA	13.6	15.2	16.8	1	1	1	22.5	67	1.5KE16A	1.5KE16CA
1.5KE18	1.5KE18C	14.5	16.2	19.8	1	1	1	26.5	56.5	1.5KE18	1.5KE18C
1.5KE18A	1.5KE18CA	15.3	17.1	18.9	1	1	1	25.2	59.5	1.5KE18A	1.5KE18CA
1.5KE20	1.5KE20C	16.2	18	22	1	1	1	29.1	51.5	1.5KE20	1.5KE20C
1.5KE20A	1.5KE20CA	17.1	19	21	1	1	1	27.7	54	1.5KE20A	1.5KE20CA
1.5KE22	1.5KE22C	17.8	19.8	24.2	1	1	1	31.9	47	1.5KE22	1.5KE22C
1.5KE22A	1.5KE22CA	18.8	20.9	23.1	1	1	1	30.6	49	1.5KE22A	1.5KE22CA
1.5KE24	1.5KE24C	19.4	21.6	26.4	1	1	1	34.7	43	1.5KE24	1.5KE24C
1.5KE24A	1.5KE24CA	20.5	22.8	25.2	1	1	1	33.2	45	1.5KE24A	1.5KE24CA
1.5KE27	1.5KE27C	21.8	24.3	29.7	1	1	1	39.1	38.5	1.5KE27	1.5KE27C
1.5KE27A	1.5KE27CA	23.1	25.7	28.4	1	1	1	37.5	40	1.5KE27A	1.5KE27CA
1.5KE30	1.5KE30C	24.3	27	33	1	1	1	43.5	34.5	1.5KE30	1.5KE30C
1.5KE30A	1.5KE30CA	25.6	28.5	31.5	1	1	1	41.4	36	1.5KE30A	1.5KE30CA
1.5KE33	1.5KE33C	26.8	29.7	36.3	1	1	1	47.7	31.5	1.5KE33	1.5KE33C
1.5KE33A	1.5KE33CA	28.2	31.4	34.7	1	1	1	45.7	33	1.5KE33A	1.5KE33CA
1.5KE36	1.5KE36C	29.1	32.4	39.6	1	1	1	52	29	1.5KE36	1.5KE36C
1.5KE36A	1.5KE36CA	30.8	34.2	37.8	1	1	1	49.9	30	1.5KE36A	1.5KE36CA
1.5KE39	1.5KE39C	31.6	35.1	42.9	1	1	1	56.4	26.5	1.5KE39	1.5KE39C
1.5KE39A	1.5KE39CA	33.3	37.1	41	1	1	1	53.9	28	1.5KE39A	1.5KE39CA
1.5KE43	1.5KE43C	34.8	38.7	47.3	1	1	1	61.9	24	1.5KE43	1.5KE43C
1.5KE43A	1.5KE43CA	36.8	40.9	45.2	1	1	1	59.3	25.3	1.5KE43A	1.5KE43CA
1.5KE47	1.5KE47C	38.1	42.3	51.7	1	1	1	67.8	22.2	1.5KE47	1.5KE47C
1.5KE47A	1.5KE47CA	40.2	44.7	49.4	1	1	1	64.8	23.2	1.5KE47A	1.5KE47CA
1.5KE51	1.5KE51C	41.3	45.9	56.1	1	1	1	73.5	20.4	1.5KE51	1.5KE51C



1.5KE SERIES

Part Number		Reverse Stand-off Voltage	Breakdown Voltage			Test Current	Reverse Leakage		Max. Clamp Voltage 10/1000µs	Peak Pulse Current 10/1000µs	Marking Code	
		V _{RWM} (Notes 4)	V _{BR} @ I _T			I _T	I _R @ V _{RWM}		V _C @ I _{PP}	I _{PP}		
			Min.	Max.			UNI	BI				
UNI	BI	V	V	V	mA	µA	µA	V	A	UNI	BI	
1500W Transient Voltage Suppressor												
1.5KE51A	1.5KE51CA	43.6	48.5	53.6	1	1	1	70.1	21.4	1.5KE51A	1.5KE51CA	
1.5KE56	1.5KE56C	45.6	50.4	61.6	1	1	1	80.5	18.6	1.5KE56	1.5KE56C	
1.5KE56A	1.5KE56CA	47.8	53.2	58.8	1	1	1	77	19.5	1.5KE56A	1.5KE56CA	
1.5KE62	1.5KE62C	50.2	55.8	68.2	1	1	1	89	16.9	1.5KE62	1.5KE62C	
1.5KE62A	1.5KE62CA	53	58.9	65.1	1	1	1	85	17.7	1.5KE62A	1.5KE62CA	
1.5KE68	1.5KE68C	55.1	61.2	74.8	1	1	1	98	15.3	1.5KE68	1.5KE68C	
1.5KE68A	1.5KE68CA	58.1	64.6	71.4	1	1	1	92	16.3	1.5KE68A	1.5KE68CA	
1.5KE75	1.5KE75C	60.7	67.5	82.5	1	1	1	108	13.9	1.5KE75	1.5KE75C	
1.5KE75A	1.5KE75CA	64.1	71.3	78.8	1	1	1	103	14.6	1.5KE75A	1.5KE75CA	
1.5KE82	1.5KE82C	66.4	73.8	90.2	1	1	1	118	12.7	1.5KE82	1.5KE82C	
1.5KE82A	1.5KE82CA	70.1	77.9	86.1	1	1	1	113	13.3	1.5KE82A	1.5KE82CA	
1.5KE91	1.5KE91C	73.7	81.9	100	1	1	1	131	11.4	1.5KE91	1.5KE91C	
1.5KE91A	1.5KE91CA	77.8	86.5	95.5	1	1	1	125	12	1.5KE91A	1.5KE91CA	
1.5KE100	1.5KE100C	81	90	110	1	1	1	144	10.4	1.5KE100	1.5KE100C	
1.5KE100A	1.5KE100CA	85.5	95	105	1	1	1	137	11	1.5KE100A	1.5KE100CA	
1.5KE110	1.5KE110C	89.2	99	121	1	1	1	158	9.5	1.5KE110	1.5KE110C	
1.5KE110A	1.5KE110CA	94	105	116	1	1	1	152	9.9	1.5KE110A	1.5KE110CA	
1.5KE120	1.5KE120C	97.2	108	132	1	1	1	173	8.7	1.5KE120	1.5KE120C	
1.5KE120A	1.5KE120CA	102	114	126	1	1	1	165	9.1	1.5KE120A	1.5KE120CA	
1.5KE130	1.5KE130C	105	117	143	1	1	1	187	8	1.5KE130	1.5KE130C	
1.5KE130A	1.5KE130CA	111	124	137	1	1	1	179	8.4	1.5KE130A	1.5KE130CA	
1.5KE150	1.5KE150C	121	135	165	1	1	1	215	7	1.5KE150	1.5KE150C	
1.5KE150A	1.5KE150CA	128	143	158	1	1	1	207	7.2	1.5KE150A	1.5KE150CA	
1.5KE160	1.5KE160C	130	144	176	1	1	1	230	6.5	1.5KE160	1.5KE160C	
1.5KE160A	1.5KE160CA	136	152	168	1	1	1	219	6.8	1.5KE160A	1.5KE160CA	
1.5KE170	1.5KE170C	138	153	187	1	1	1	244	6.2	1.5KE170	1.5KE170C	
1.5KE170A	1.5KE170CA	145	162	179	1	1	1	234	6.4	1.5KE170A	1.5KE170CA	
1.5KE180	1.5KE180C	146	162	198	1	1	1	258	5.8	1.5KE180	1.5KE180C	
1.5KE180A	1.5KE180CA	154	171	189	1	1	1	246	6.1	1.5KE180A	1.5KE180CA	
1.5KE200	1.5KE200C	162	180	220	1	1	1	287	5.2	1.5KE200	1.5KE200C	
1.5KE200A	1.5KE200CA	171	190	210	1	1	1	274	5.5	1.5KE200A	1.5KE200CA	
1.5KE220	1.5KE220C	175	198	242	1	1	1	344	4.3	1.5KE220	1.5KE220C	
1.5KE220A	1.5KE220CA	185	209	231	1	1	1	328	4.6	1.5KE220A	1.5KE220CA	
1.5KE250	1.5KE250C	202	225	275	1	1	1	360	4.3	1.5KE250	1.5KE250C	
1.5KE250A	1.5KE250CA	214	237	263	1	1	1	344	4.5	1.5KE250A	1.5KE250CA	
1.5KE300	1.5KE300C	243	270	330	1	1	1	430	3.6	1.5KE300	1.5KE300C	
1.5KE300A	1.5KE300CA	256	285	315	1	1	1	414	3.8	1.5KE300A	1.5KE300CA	
1.5KE350	1.5KE350C	284	315	385	1	1	1	504	3.1	1.5KE350	1.5KE350C	
1.5KE350A	1.5KE350CA	300	332	368	1	1	1	482	3.2	1.5KE350A	1.5KE350CA	
1.5KE400	1.5KE400C	324	360	440	1	1	1	574	2.7	1.5KE400	1.5KE400C	
1.5KE400A	1.5KE400CA	342	380	420	1	1	1	548	2.8	1.5KE400A	1.5KE400CA	
1.5KE440	1.5KE440C	356	396	484	1	1	1	631	2.4	1.5KE440	1.5KE440C	
1.5KE440A	1.5KE440CA	376	418	462	1	1	1	600	2.6	1.5KE440A	1.5KE440CA	



1.5KE SERIES

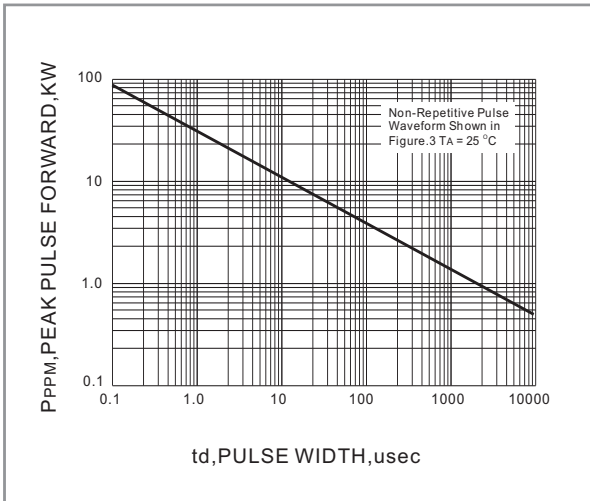

Fig.1 PEAK PULSE POWER RATING VERSUS PULSE TIME CURVE

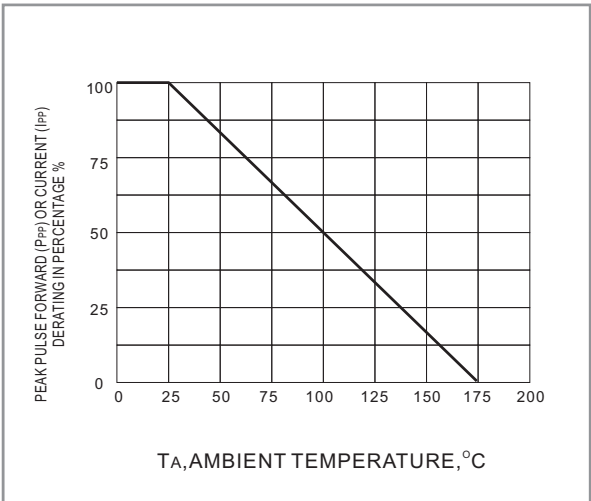

Fig.2 PULSE DERATING CURVE

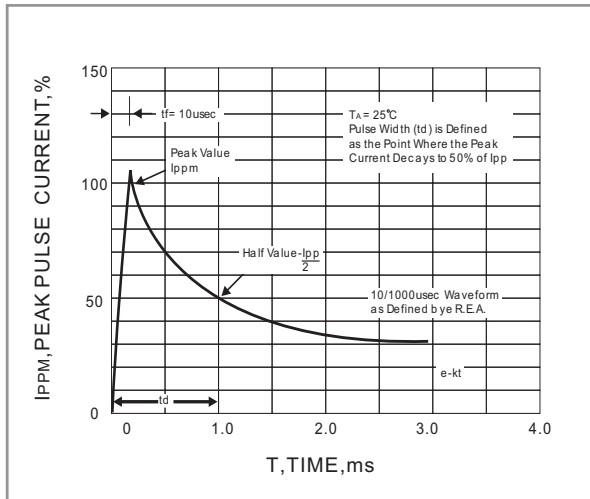

Fig.3 PULSE WAVEFORM

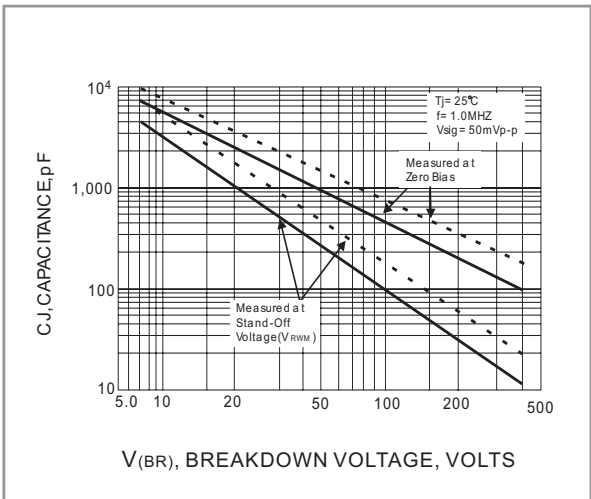

Fig.4 TYPICAL JUNCTION CAPACITANCE

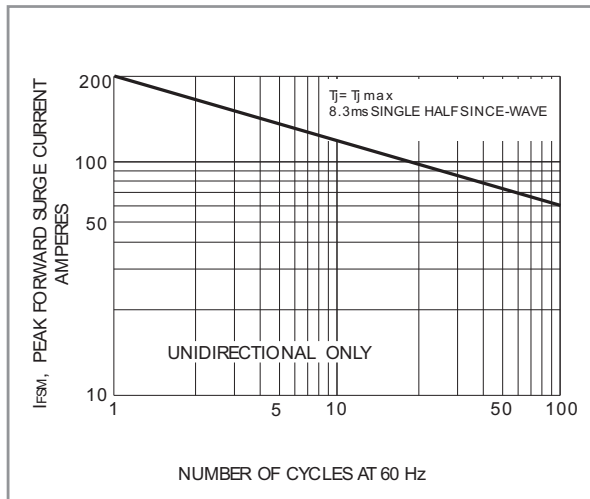

Fig.5 MAXIMUM NON-REPETITIVE PEAK FORWARD SURGE CURRENT UNIDIRECTIONAL



1.5KE SERIES

Part No._packing code_Version

- 1.5KE6.8_AY_00001
- 1.5KE6.8_AY_10001
- 1.5KE6.8_B0_00001
- 1.5KE6.8_B0_10001
- 1.5KE6.8_R2_00001
- 1.5KE6.8_R2_10001

For example :

RB500V-40_R2_00001

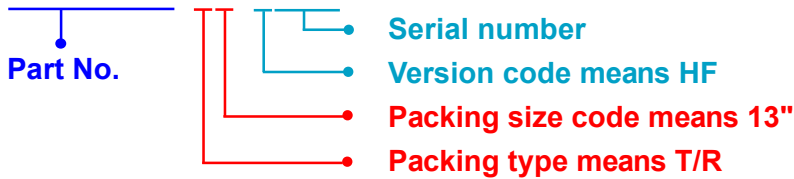

Packing Code XX				Version Code XXXXXX		
Packing type	1 st Code	Packing size code	2 nd Code	HF or RoHS	1 st Code	2 nd ~5 th Code
Tape and Ammunition Box (T/B)	A	N/A	0	HF	0	serial number
Tape and Reel (T/R)	R	7"	1	RoHS	1	serial number
Bulk Packing (B/P)	B	13"	2			
Tube Packing (T/P)	T	26mm	X			
Tape and Reel (Right Oriented) (TRR)	S	52mm	Y			
Tape and Reel (Left Oriented) (TRL)	L	PANASERT T/B CATHODE UP (PBCU)	U			
FORMING	F	PANASERT T/B CATHODE DOWN (PBCD)	D			