

**GPP TRANSIENT VOLTAGE SUPPRESSOR
1500 WATT PEAK POWER 6.5 WATTS STEADY STATE**

FEATURES

- * Plastic package has underwriters laboratory
- * Glass passivated chip construction
- * 1500 watt surge capability at 1ms
- * Excellent clamping capability
- * Low zener impedance
- * Fast response time

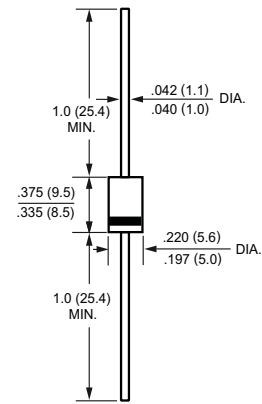

MAXIMUM RATINGS AND ELECTRICAL CHARACTERISTICS

Ratings at 25 °C ambient temperature unless otherwise specified.

Single phase, half wave, 60 Hz, resistive or inductive load,
For capacitive load, derate current by 20%.

MAXIMUM RATINGS (@ TA=25 °C unless otherwise noted)

| RATINGS | SYMBOL | VALUE | UNITS |
|--|------------------|--------------|------------------|
| Peak Power Dissipation at TA = 25°C, TP = 1mS (Note 1) | PPPM | Minimum 1500 | W |
| Steady State Power Dissipation at TL = 75°C lead length, .375" (9.5 mm) (Note 2) | PM(AV) | 6.5 | W |
| Peak Forward Surge Current, 8.3mS Single half sine-wave superimposed on rated load (JEDEC METHODE) | IFSM | 200 | A |
| Typical Current Squared Time | I ² T | 166 | A ² S |
| Maximum instantaneous forwards voltage at 50A for unidirectional only (Note 4) | VF | 3.5/5.0 | V |
| Operating and Storage Temperature Range | TJ, TSTG | -55 to + 150 | °C |

- NOTES : 1. Non-repetitive current pulse, per Fig.3 and derated above TA = 25°C per Fig.2.
 2. Mounted on 0.2 X 0.2" (5.0 X 5.0mm) copper pad to each terminal.
 3. "Fully ROHS compliant", "100% Sn plating (Pb-free)".
 4. VF =3.5V max. for devices of V(BR) ≤220V and VF =5.0Volts for device of V(BR) ≥220V.

RATING AND CHARACTERISTICS CURVES (1.5KE6.8 THRU 1.5KE600CA)

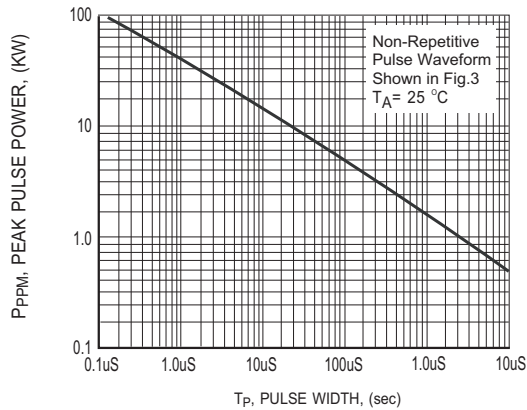

FIG.1 PEAK PULSE POWER RATING CURVE

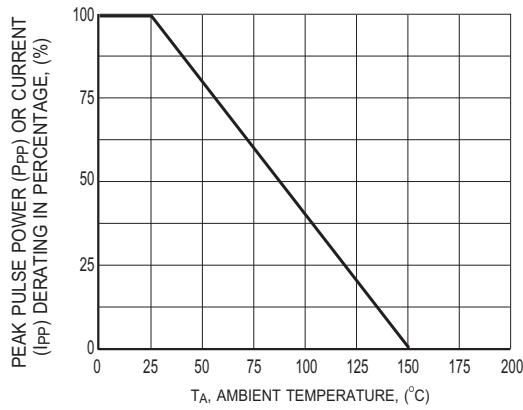

FIG.2 PULSE DERATING CURVE

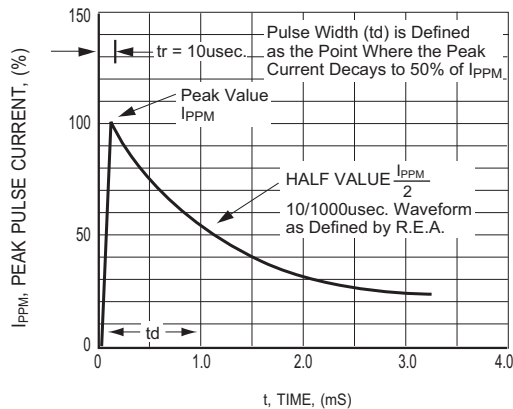

FIG.3 PULSE WAVEFORM

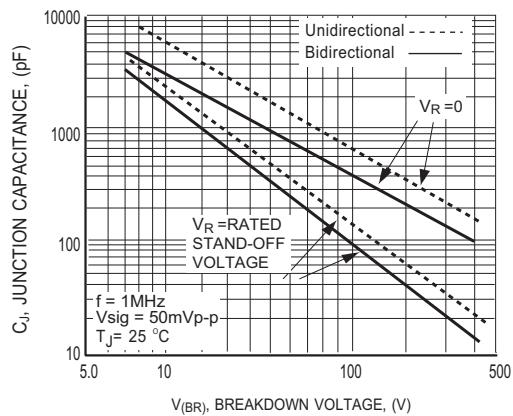

FIG.4 TYPICAL JUNCTION CAPACITANCE BIDIRECTIONAL

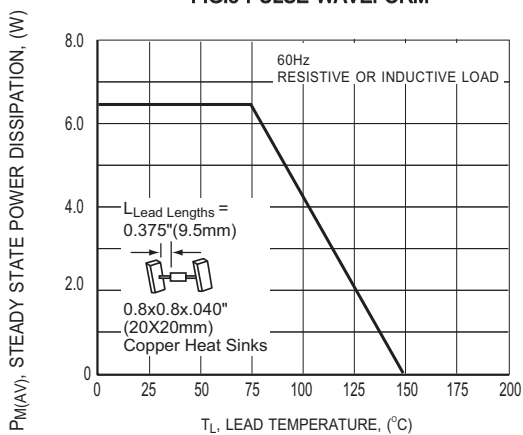

FIG.5 STEADY STATE POWER DERATING CURVE

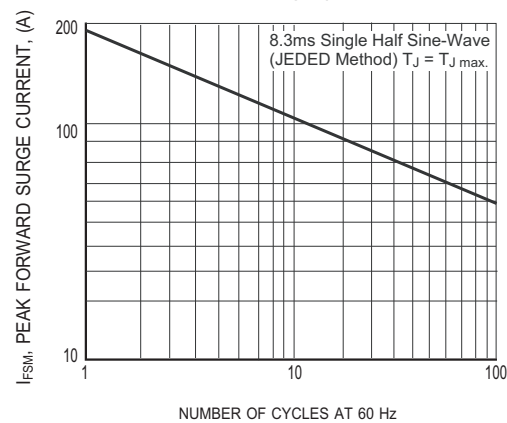

FIG.6 MAXIMUM NON-REPETITIVE FORWARD SURGE CURRENT UNIDIRECTIONAL

RATING AND CHARACTERISTICS CURVES (1.5KE6.8 THRU 1.5KE600CA)

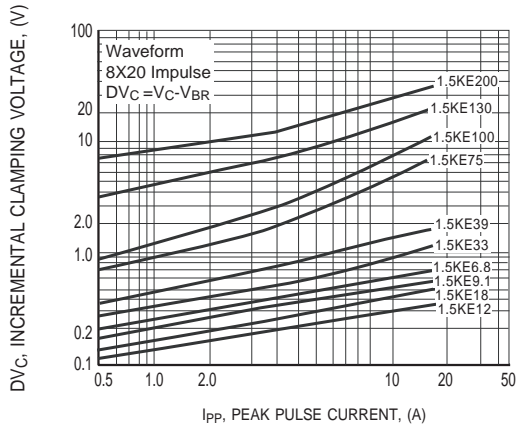

FIG.7 INCREMENTAL CLAMPING VOLTAGE CURVE UNIDIRECTIONAL

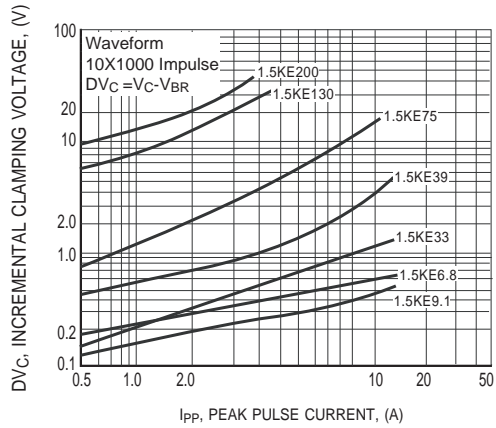

FIG.8 INCREMENTAL CLAMPING VOLTAGE CURVE UNIDIRECTIONAL

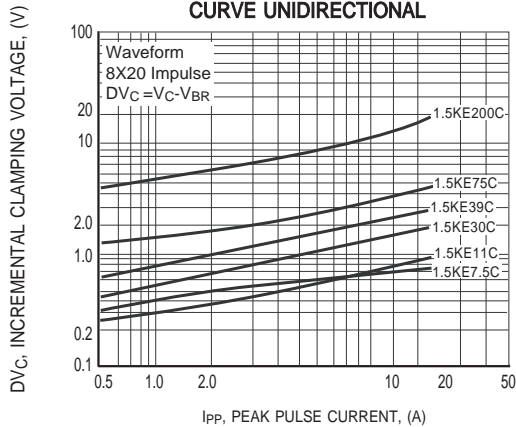

FIG.9 INCREMENTAL CLAMPING VOLTAGE CURVE UNIDIRECTIONAL

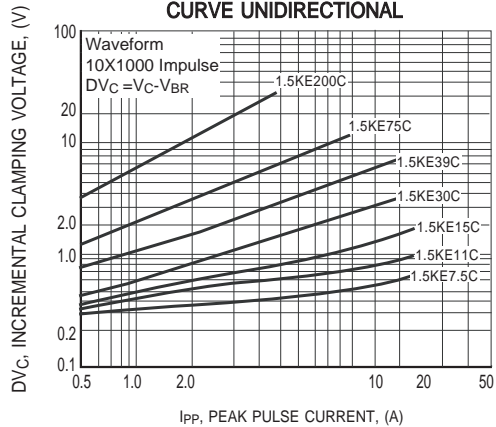

FIG.10 INCREMENTAL CLAMPING VOLTAGE CURVE UNIDIRECTIONAL

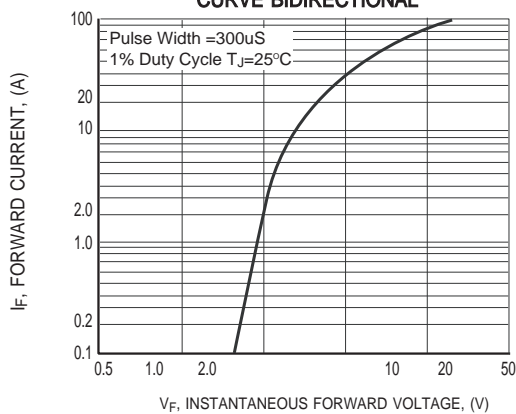

FIG.11 INSTANTANEOUS FORWARD VOLTAGE CHARACTERISTICS CURVE

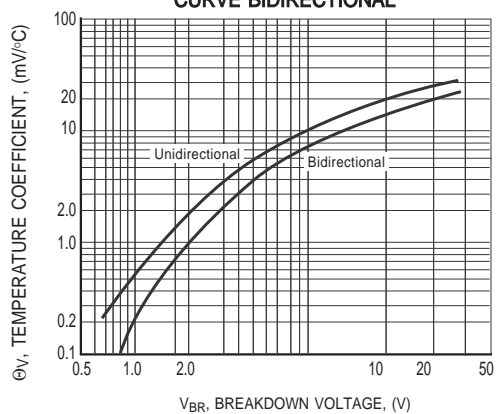

FIG.12 BREAKDOWN VOLTAGE TEMPERATURE COEFFICIENT CURVE

TRANSIENT VOLTAGE SUPPRESSORS

1500W SERIES TVS DIODES/ 1.5KE (CASE 10) 1500W

| TYPE | Breakdown Voltage | | | Reverse Stand off Voltage V_{WM} (Volts) | Maximum Reverse Leakage at V_{WM} I_D (μ A) | Maximum Peak Pulse Current I_{PPM} (Amps) | Maximum Clamping Voltage at I_{PPM} V_C (Volts) |
|-----------|-------------------|------|----------|--|--|---|---|
| | VBR (Volts) | | @IT (mA) | | | | |
| | MIN. | MAX. | | | | | |
| 1.5KE6.8 | 6.12 | 7.48 | 10 | 5.50 | 1000 | 139 | 10.8 |
| 1.5KE6.8A | 6.45 | 7.14 | 10 | 5.80 | 1000 | 143 | 10.5 |
| 1.5KE7.5 | 6.75 | 8.25 | 10 | 6.05 | 500 | 128 | 11.7 |
| 1.5KE7.5A | 7.13 | 7.88 | 10 | 6.40 | 500 | 133 | 11.3 |
| 1.5KE8.2 | 7.38 | 9.02 | 10 | 6.63 | 200 | 120 | 12.5 |
| 1.5KE8.2A | 7.79 | 8.61 | 10 | 7.02 | 200 | 124 | 12.1 |
| 1.5KE9.1 | 8.19 | 10.0 | 1.0 | 7.37 | 50 | 109 | 13.8 |
| 1.5KE9.1A | 8.65 | 9.55 | 1.0 | 7.78 | 50 | 112 | 13.4 |
| 1.5KE10 | 9.00 | 11.0 | 1.0 | 8.10 | 10 | 100 | 15.0 |
| 1.5KE10A | 9.50 | 10.5 | 1.0 | 8.55 | 10 | 103 | 14.5 |
| 1.5KE11 | 9.90 | 12.1 | 1.0 | 8.92 | 5.0 | 92.6 | 16.2 |
| 1.5KE11A | 10.5 | 11.6 | 1.0 | 9.40 | 5.0 | 96.2 | 15.6 |
| 1.5KE12 | 10.8 | 13.2 | 1.0 | 9.72 | 5.0 | 86.7 | 17.3 |
| 1.5KE12A | 11.4 | 12.6 | 1.0 | 10.2 | 5.0 | 89.8 | 16.7 |
| 1.5KE13 | 11.7 | 14.3 | 1.0 | 10.5 | 5.0 | 78.9 | 19.0 |
| 1.5KE13A | 12.4 | 13.7 | 1.0 | 11.1 | 5.0 | 82.4 | 18.2 |
| 1.5KE15 | 13.5 | 16.5 | 1.0 | 12.1 | 5.0 | 68.2 | 22.0 |
| 1.5KE15A | 14.3 | 15.8 | 1.0 | 12.8 | 5.0 | 70.8 | 21.2 |
| 1.5KE16 | 14.4 | 17.6 | 1.0 | 12.9 | 5.0 | 63.8 | 23.5 |
| 1.5KE16A | 15.2 | 16.8 | 1.0 | 13.6 | 5.0 | 66.7 | 22.5 |
| 1.5KE18 | 16.2 | 19.8 | 1.0 | 14.5 | 5.0 | 56.6 | 26.5 |
| 1.5KE18A | 17.1 | 18.9 | 1.0 | 15.3 | 5.0 | 59.5 | 25.2 |
| 1.5KE20 | 18.0 | 22.0 | 1.0 | 16.2 | 5.0 | 51.5 | 29.1 |
| 1.5KE20A | 19.0 | 21.0 | 1.0 | 17.1 | 5.0 | 54.2 | 27.7 |
| 1.5KE22 | 19.8 | 24.2 | 1.0 | 17.8 | 5.0 | 47 | 31.9 |
| 1.5KE22A | 20.9 | 23.1 | 1.0 | 18.8 | 5.0 | 49 | 30.6 |
| 1.5KE24 | 21.6 | 26.4 | 1.0 | 19.4 | 5.0 | 43.2 | 34.7 |
| 1.5KE24A | 22.8 | 25.2 | 1.0 | 20.5 | 5.0 | 45.2 | 33.2 |
| 1.5KE27 | 24.3 | 29.7 | 1.0 | 21.8 | 5.0 | 38.4 | 39.1 |
| 1.5KE27A | 25.7 | 28.4 | 1.0 | 23.1 | 5.0 | 40 | 37.5 |
| 1.5KE30 | 27.0 | 33.0 | 1.0 | 24.3 | 5.0 | 34.5 | 43.5 |
| 1.5KE30A | 28.5 | 31.5 | 1.0 | 25.6 | 5.0 | 36.2 | 41.4 |
| 1.5KE33 | 29.7 | 36.3 | 1.0 | 26.8 | 5.0 | 31.4 | 47.7 |
| 1.5KE33A | 31.4 | 34.7 | 1.0 | 28.2 | 5.0 | 32.8 | 45.7 |
| 1.5KE36 | 32.4 | 39.6 | 1.0 | 29.1 | 5.0 | 28.8 | 52.0 |
| 1.5KE36A | 34.2 | 37.8 | 1.0 | 30.8 | 5.0 | 30.1 | 49.9 |
| 1.5KE39 | 35.1 | 42.9 | 1.0 | 31.6 | 5.0 | 26.6 | 56.4 |
| 1.5KE39A | 37.1 | 41.0 | 1.0 | 33.3 | 5.0 | 27.8 | 53.9 |
| 1.5KE43 | 38.7 | 47.3 | 1.0 | 34.8 | 5.0 | 24.2 | 61.9 |
| 1.5KE43A | 40.9 | 45.2 | 1.0 | 36.8 | 5.0 | 25.3 | 59.3 |
| 1.5KE47 | 42.3 | 51.7 | 1.0 | 38.1 | 5.0 | 22.1 | 67.8 |
| 1.5KE47A | 44.7 | 49.4 | 1.0 | 40.2 | 5.0 | 23.1 | 64.8 |
| 1.5KE51 | 45.9 | 56.1 | 1.0 | 41.3 | 5.0 | 20.4 | 73.5 |
| 1.5KE51A | 48.5 | 53.6 | 1.0 | 43.6 | 5.0 | 21.4 | 70.1 |
| 1.5KE56 | 50.4 | 61.6 | 1.0 | 45.4 | 5.0 | 18.6 | 80.5 |
| 1.5KE56A | 53.2 | 58.8 | 1.0 | 47.8 | 5.0 | 19.5 | 77.0 |

TRANSIENT VOLTAGE SUPPRESSORS

1500W SERIES TVS DIODES/ 1.5KE (CASE 10) 1500W

| TYPE | Breakdown Voltage | | @I _T (mA) | Reverse Stand off Voltage V _{WM} (Volts) | Maximum Reverse Leakage at V _{WM} I _D (uA) | Maximum Peak Pulse Current I _{PPM} (Amps) | Maximum Clamping Voltage at I _{PPM} V _C (Volts) |
|-----------|----------------------------|-------|-------------------------|---|---|--|--|
| | V _{BR} (Volts) | | | | | | |
| | MIN. | MAX. | | | | | |
| 1.5KE62 | 55.8 | 68.2 | 1.0 | 50.2 | 5.0 | 16.9 | 89.0 |
| 1.5KE62A | 58.9 | 65.1 | 1.0 | 53.0 | 5.0 | 17.6 | 85.0 |
| 1.5KE68 | 61.2 | 74.8 | 1.0 | 55.1 | 5.0 | 15.3 | 98.0 |
| 1.5KE68A | 64.6 | 71.4 | 1.0 | 58.1 | 5.0 | 16.3 | 92.0 |
| 1.5KE75 | 67.5 | 82.5 | 1.0 | 60.7 | 5.0 | 13.9 | 109 |
| 1.5KE75A | 71.3 | 78.8 | 1.0 | 64.1 | 5.0 | 14.6 | 104 |
| 1.5KE82 | 73.8 | 90.2 | 1.0 | 66.4 | 5.0 | 12.7 | 118 |
| 1.5KE82A | 77.9 | 86.1 | 1.0 | 70.1 | 5.0 | 13.3 | 113 |
| 1.5KE91 | 81.9 | 100 | 1.0 | 73.7 | 5.0 | 11.5 | 131 |
| 1.5KE91A | 86.5 | 95.5 | 1.0 | 77.8 | 5.0 | 12.0 | 125 |
| 1.5KE100 | 90.0 | 110 | 1.0 | 81.0 | 5.0 | 10.4 | 144 |
| 1.5KE100A | 95.0 | 105 | 1.0 | 85.5 | 5.0 | 10.9 | 137 |
| 1.5KE110 | 99.0 | 121 | 1.0 | 89.2 | 5.0 | 9.5 | 158 |
| 1.5KE110A | 105 | 116 | 1.0 | 94.0 | 5.0 | 9.9 | 152 |
| 1.5KE120 | 108 | 132 | 1.0 | 97.2 | 5.0 | 8.7 | 173 |
| 1.5KE120A | 114 | 126 | 1.0 | 102 | 5.0 | 9.1 | 165 |
| 1.5KE130 | 117 | 143 | 1.0 | 105 | 5.0 | 8.0 | 187 |
| 1.5KE130A | 124 | 137 | 1.0 | 111 | 5.0 | 8.4 | 179 |
| 1.5KE150 | 135 | 165 | 1.0 | 121 | 5.0 | 7.0 | 215 |
| 1.5KE150A | 143 | 158 | 1.0 | 128 | 5.0 | 7.2 | 207 |
| 1.5KE160 | 144 | 176 | 1.0 | 130 | 5.0 | 6.5 | 230 |
| 1.5KE160A | 152 | 168 | 1.0 | 136 | 5.0 | 6.8 | 219 |
| 1.5KE170 | 153 | 187 | 1.0 | 138 | 5.0 | 6.1 | 244 |
| 1.5KE170A | 162 | 179 | 1.0 | 145 | 5.0 | 6.4 | 234 |
| 1.5KE180 | 162 | 198 | 1.0 | 146 | 5.0 | 5.8 | 258 |
| 1.5KE180A | 171 | 189 | 1.0 | 154 | 5.0 | 6.1 | 246 |
| 1.5KE200 | 180 | 220 | 1.0 | 162 | 5.0 | 5.2 | 287 |
| 1.5KE200A | 190 | 210 | 1.0 | 171 | 5.0 | 5.5 | 274 |
| 1.5KE220 | 198 | 242 | 1.0 | 175 | 5.0 | 4.4 | 344 |
| 1.5KE220A | 209 | 231 | 1.0 | 185 | 5.0 | 4.6 | 328 |
| 1.5KE250 | 225 | 275 | 1.0 | 202 | 5.0 | 4.2 | 360 |
| 1.5KE250A | 237 | 263 | 1.0 | 214 | 5.0 | 4.4 | 344 |
| 1.5KE300 | 270 | 330 | 1.0 | 243 | 5.0 | 3.5 | 430 |
| 1.5KE300A | 285 | 315 | 1.0 | 256 | 5.0 | 3.6 | 414 |
| 1.5KE350 | 315 | 385 | 1.0 | 284 | 5.0 | 3.0 | 504 |
| 1.5KE350A | 333 | 368 | 1.0 | 300 | 5.0 | 3.1 | 482 |
| 1.5KE400 | 360 | 440 | 1.0 | 324 | 5.0 | 2.6 | 574 |
| 1.5KE400A | 380 | 420 | 1.0 | 342 | 5.0 | 2.7 | 548 |
| 1.5KE440 | 396 | 484 | 1.0 | 356 | 5.0 | 2.4 | 631 |
| 1.5KE440A | 418 | 462 | 1.0 | 376 | 5.0 | 2.5 | 602 |
| 1.5KE480A | 456 | 504 | 1.0 | 408 | 5.0 | 2.3 | 658 |
| 1.5KE510A | 485 | 535 | 1.0 | 434 | 5.0 | 2.1 | 698 |
| 1.5KE530A | 503.5 | 556.5 | 1.0 | 477 | 5.0 | 2.1 | 725 |
| 1.5KE540A | 513 | 567 | 1.0 | 486 | 5.0 | 2.0 | 740 |
| 1.5KE550A | 522.5 | 577.5 | 1.0 | 495 | 5.0 | 2.0 | 760 |
| 1.5KE600A | 570 | 630 | 1.0 | 512 | 5.0 | 1.8 | 828 |

- Notes :
1. V_{BR} measured after I_T applied for 300ms. I_T = square pulse or equivalent.
 2. For bidirectional use C or CA suffixs for all types (ex. 1.5KE6.8C, 1.5KE600CA) electrical characteristics apply in both directions.
 3. For bidirectional types having V_{WM} of 10 volts and less, the I_D limit is doubled.
 4. All devices UL listed file# E211196.



Attachment information about 1.5KEXX (C) A

1. Internal Circuit



2. Marking on the body

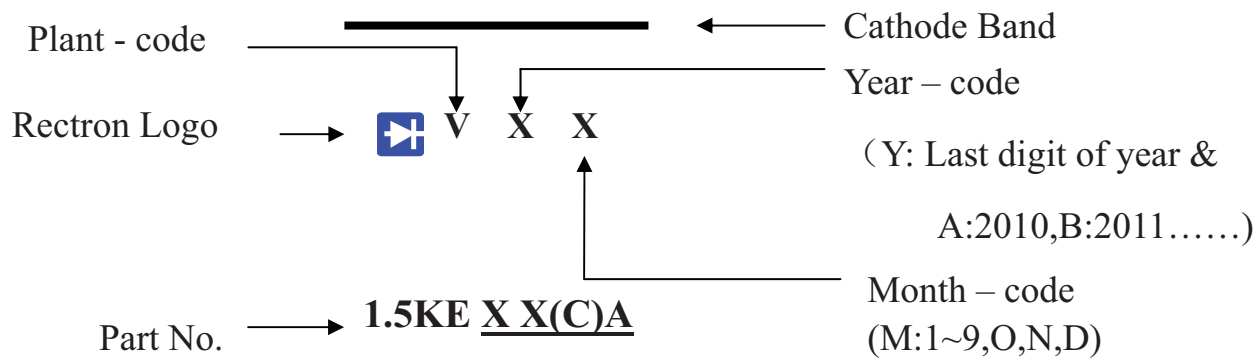

PACKAGING OF DIODE AND BRIDGE RECTIFIERS

REEL PACK

| PACKAGE | PACKING CODE | EA PER REEL | EA PER INNER BOX | COMPONENT SPACE (mm) | TAPE SPACE (mm) | REEL DIA (mm) | CARTON SIZE (mm) | EA PER CARTON | GROSS WEIGHT(Kg) |
|---------|--------------|-------------|------------------|----------------------|-----------------|---------------|------------------|---------------|------------------|
| 1.5KE | -T | 1,200 | 1,200 | 10.0 | 52 | 330 | 355*350*335 | 4,800 | 8.05 |