

## 1500 W TVS in DO-201

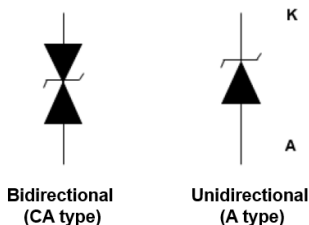
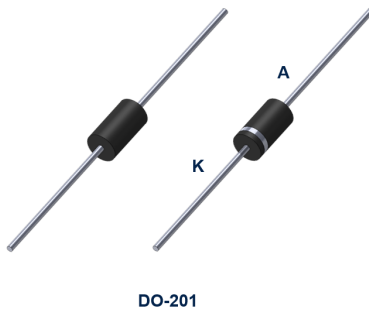

## Product status link

1.5KE6V8A, 1.5KE6V8CA, 1.5KE12A,  
 1.5KE12CA, 1.5KE15A, 1.5KE15CA,  
 1.5KE18A, 1.5KE18CA, 1.5KE27A,  
 1.5KE27CA, 1.5KE30A, 1.5KE30CA,  
 1.5KE33A, 1.5KE33CA, 1.5KE36A,  
 1.5KE36CA, 1.5KE39A, 1.5KE39CA,  
 1.5KE47A, 1.5KE47CA, 1.5KE56A,  
 1.5KE56CA, 1.5KE62A, 1.5KE62CA,  
 1.5KE68A, 1.5KE68CA, 1.5KE82A,  
 1.5KE82CA, 1.5KE100A, 1.5KE100CA,  
 1.5KE120A, 1.5KE120CA, 1.5KE150A,  
 1.5KE150CA, 1.5KE180A, 1.5KE180CA,  
 1.5KE200A, 1.5KE200CA, 1.5KE220A,  
 1.5KE220CA, 1.5KE250A, 1.5KE250CA,  
 1.5KE300A, 1.5KE300CA, 1.5KE350A,  
 1.5KE350CA, 1.5KE400A, 1.5KE400CA,  
 1.5KE440A, 1.5KE440CA

## Features

- Peak pulse power:
  - 1500 W (10/1000  $\mu$ s)
  - up to 10 kW (8/20  $\mu$ s)
- Stand-off voltage range from 5 V to 376 V
- Unidirectional and bidirectional types
- Operating  $T_j$  max: 175 °C
- High power capability at  $T_j$  max.: up to 1100 W (10/1000  $\mu$ s)
- Lead finishing: matte tin plating

## Complies with the following standards

- UL94, V0
- J-STD-020 MSL level 1
- J-STD-002, JESD 22-B102 E3 and MIL-STD-750, method 2026
- JESD-201 class 2 whisker test
- UL 497B file number: QVGQ2.E136224
- IEC 61000-4-4 level 4:
  - 4 k V
- IEC 61000-4-2, C = 150 pF, R = 330  $\Omega$  exceeds level 4:
  - 30 kV (air discharge)
  - 30 kV (contact discharge)

## Description

The 1.5KE TVS series is designed to protect sensitive equipment against electrostatic discharges according to IEC 61000-4-2, MIL STD 883 Method 3015, and electrical overstress such as IEC 61000-4-4 and 5. They are used for surges below 1500 W 10/1000  $\mu$ s.

This planar technology makes it compatible with high-end equipment and SMPS where low leakage current and high junction temperature are required to provide reliability and stability over time.

# 1 Characteristics

**Table 1. Absolute maximum ratings ( $T_{amb} = 25\text{ }^{\circ}\text{C}$ )**

Symbol	Parameter	Value	Unit	
$V_{PP}$	Peak pulse voltage	IEC 61000-4-2 (C = 150 pF, R = 330 $\Omega$ )		
		Contact discharge	30	kV
	Air discharge	30		
$P_{PP}$	Peak pulse power dissipation	10/1000 $\mu\text{s}$ , $T_j$ initial = $T_{amb}$	1500	W
$I_{FSM}$	Non repetitive surge peak forward current for unidirectional types	$t_p = 10\text{ ms}$ , $T_j$ initial = $T_{amb}$	200	A
$T_{stg}$	Storage temperature range		-65 to +175	$^{\circ}\text{C}$
$T_j$	Operating junction temperature range		-55 to +175	$^{\circ}\text{C}$
$T_L$	Maximum lead temperature for soldering during 10 s at 5 mm from case		260	$^{\circ}\text{C}$

**Figure 1. Electrical characteristics - parameter definitions**

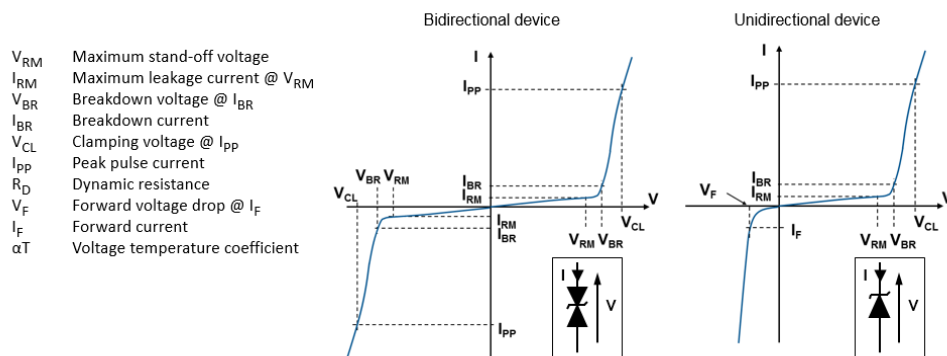

**Figure 2. Pulse definition for electrical characteristics**

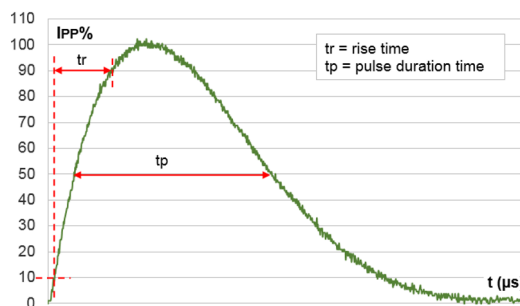

**Table 2. Electrical characteristics - parameter values ( $T_{amb} = 25\text{ °C}$ , unless otherwise specified)**

Type	$I_{RM}$ max at $V_{RM}$		$V_{BR}$ at $I_{BR}^{(1)}$				10 / 1000 $\mu s$			8 / 20 $\mu s$			$\alpha T$
							$V_{CL}^{(2)(3)}$	$I_{PP}^{(4)}$	$R_D$	$V_{CL}^{(2)(3)}$	$I_{PP}^{(4)}$	$R_D$	
	25 °C		Min.	Typ.	Max.		Max.		Max.	Max.		Max.	
	$\mu A$	V	V			mA	V	A	$\Omega$	V	A	$\Omega$	$10^{-4}/\text{°C}$
1.5KE6V8A/CA	1000	5.8	6.45	6.8	7.14	10	10.5	143	0.023	13.4	746	0.008	5.7
1.5KE10A/CA	10	8.55	9.5	10	10.5	1	14.5	100	0.040	18.6	538	0.015	7.3
1.5KE12A/CA	5	10.2	11.4	12	12.6	1	16.7	90	0.046	21.7	461	0.020	7.8
1.5KE15A/CA	1	12.8	14.3	15	15.8	1	21.2	71	0.076	27.2	368	0.031	8.4
1.5KE18A/CA	1	15.3	17.1	18	18.9	1	25.2	59.5	0.106	32.5	308	0.044	8.8
1.5KE24A/CA	1	20.5	22.8	24	25.2	1	33.2	45	0.178	42.8	234	0.075	9.4
1.5KE27A/CA	1	23.1	25.7	27	28.4	1	37.5	40	0.228	48.3	207	0.096	9.6
1.5KE30A/CA	1	25.6	28.5	30	31.5	1	41.5	36	0.278	53.5	187	0.118	9.7
1.5KE33A/CA	1	28.2	31.4	33	34.7	1	45.7	33	0.333	59	169	0.144	9.8
1.5KE36A/CA	1	30.8	34.2	36	37.8	1	49.9	30	0.403	64.3	156	0.170	9.9
1.5KE39A/CA	1	33.3	37.1	39	41	1	53.9	28	0.461	69.7	143	0.201	10.0
1.5KE47A/CA	1	40.2	44.7	47	49.4	1	64.8	23.2	0.664	84	119	0.291	10.1
1.5KE56A/CA	1	47.8	53.2	56	58.8	1	77	19.5	0.933	100	100	0.412	10.3
1.5KE62A/CA	1	53.0	58.9	62	65.1	1	85	17.7	1.12	111	90	0.510	10.4
1.5KE68A/CA	1	58.1	64.6	68	71.4	1	92	16.3	1.26	121	83	0.598	10.4
1.5KE82A/CA	1	70.1	77.9	82	86.1	1	113	13.3	2.02	146	69	0.868	10.5
1.5KE100A/CA	1	85.5	95.0	100	105	1	137	11	2.91	178	56	1.30	10.6
1.5KE120A/CA	1	102	114	120	126	1	165	9.1	4.29	212	47	1.83	10.7
1.5KE150A/CA	1	128	143	150	158	1	207	7.2	6.81	265	38	2.82	10.8
1.5KE180A/CA	1	154	171	180	189	1	246	6.1	9.34	317	31.5	4.06	10.8
1.5KE200A/CA	1	171	190	200	210	1	274	5.5	11.6	353	28	5.11	10.8
1.5KE220A/CA	1	188	209	220	231	1	328	4.6	21.1	388	26	6.04	10.8
1.5KE250A/CA	1	213	237	250	263	1	344	5.0	16.2	442	23	7.78	11
1.5KE300A/CA	1	256	285	300	315	1	414	5.0	19.8	529	19	11.3	11
1.5KE350A/CA	1	299	332	350	368	1	482	4.0	28.5	618	16	15.6	11
1.5KE400A/CA	1	342	380	400	420	1	548	4.0	32.0	706	14	20.4	11
1.5KE440A/CA	1	376	418	440	462	1	603	3.5	40.3	776	13	24.2	11

1. To calculate  $V_{BR}$  versus  $T_j$ :  $V_{BR}$  at  $T_j = V_{BR}$  at  $25\text{ °C} \times (1 + \alpha T \times (T_j - 25))$
2. To calculate  $V_{CL}$  versus  $T_j$ :  $V_{CL}$  at  $T_j = V_{CL}$  at  $25\text{ °C} \times (1 + \alpha T \times (T_j - 25))$
3. To calculate  $V_{CL}$  max versus  $I_{PP\text{appli}}$ :  $V_{CL\text{max}} = V_{CL} - R_D \times (I_{PP} - I_{PP\text{appli}})$  where  $I_{PP\text{appli}}$  is the surge current in the application
4. Surge capability given for both directions for unidirectional (A type) and bidirectional (CA type) devices

## 1.1 Characteristics (curves)

**Figure 3. Maximum peak power dissipation versus initial junction temperature**

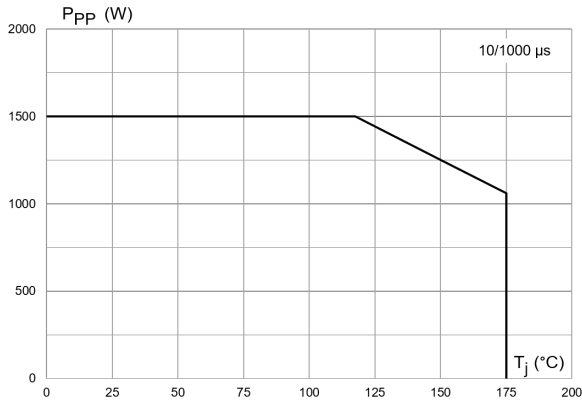

**Figure 4. Maximum peak pulse power versus exponential pulse duration**

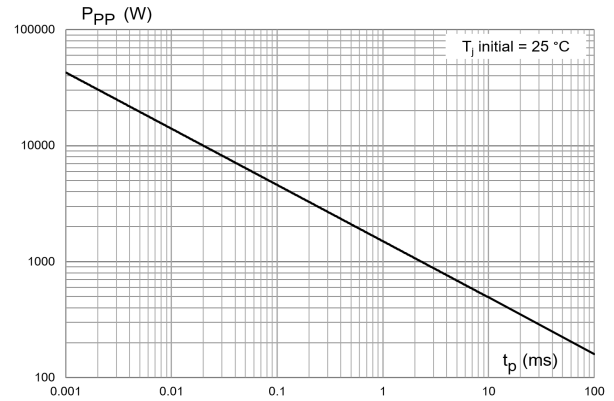

**Figure 5. Maximum peak pulse current versus clamping voltage**

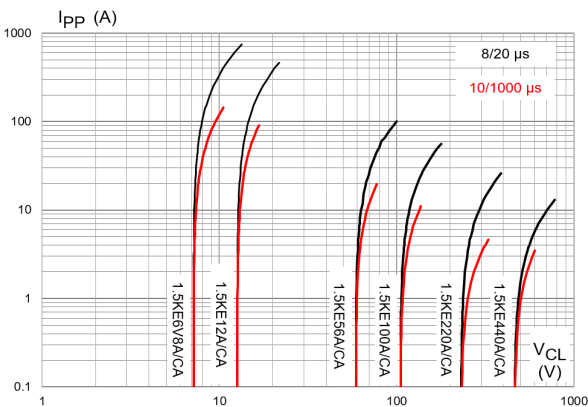

**Figure 6. Dynamic resistance versus pulse duration**

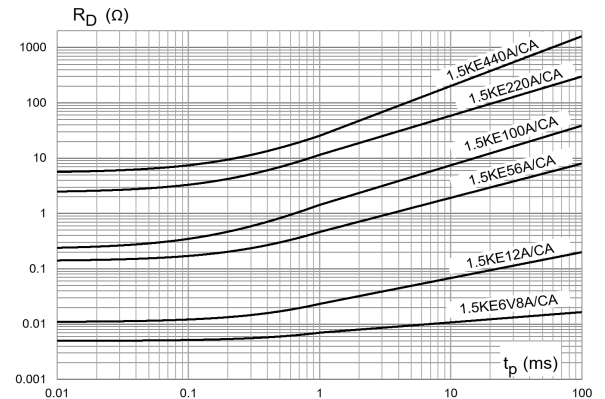

**Figure 7. Junction capacitance versus reverse applied voltage (unidirectional type)**

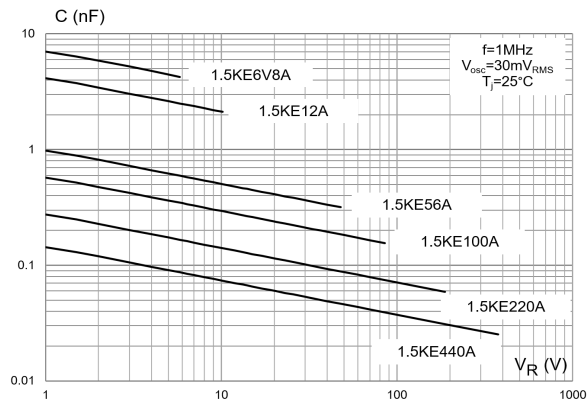

**Figure 8. Junction capacitance versus applied voltage (bidirectional type)**

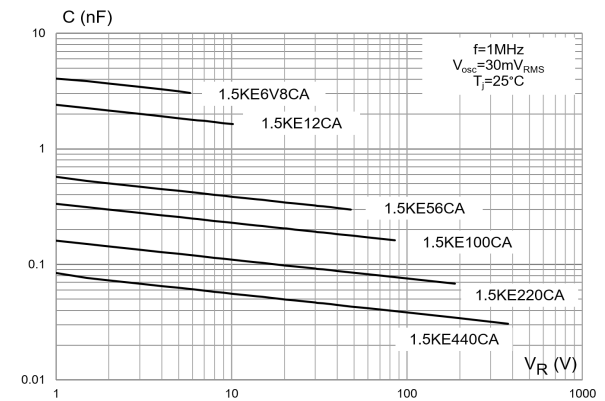

Figure 9. Leakage current versus junction temperature

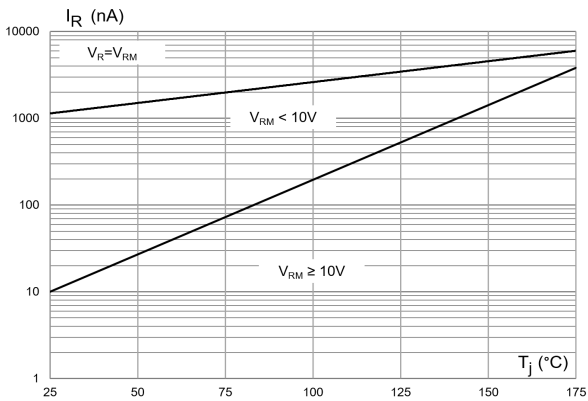

Figure 10. Peak forward voltage drop versus peak forward current

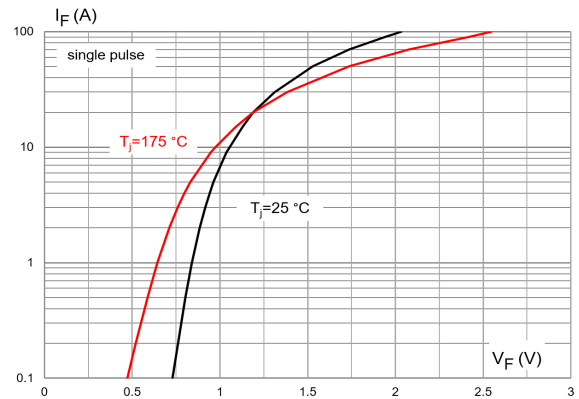

Figure 11. Thermal impedance junction to ambient versus pulse duration

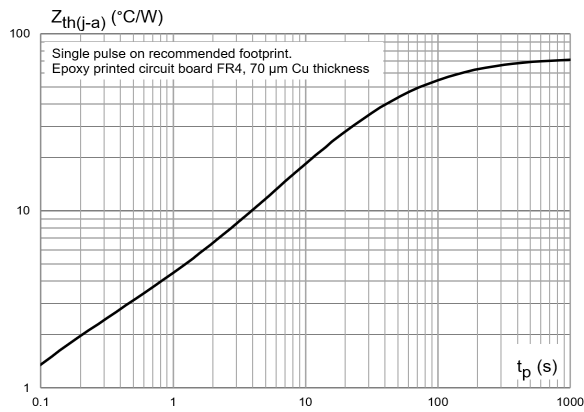
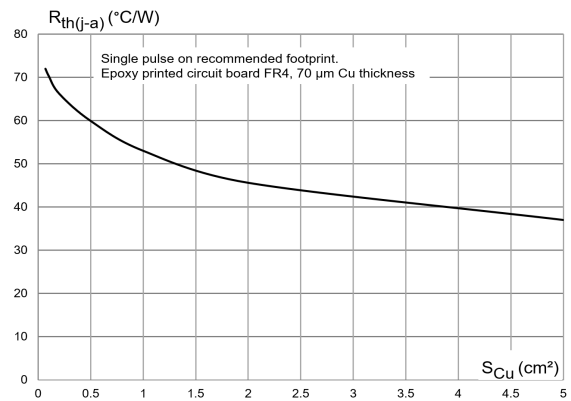

Figure 12. Thermal resistance junction to ambient versus copper area under each lead



## 2 Package information

In order to meet environmental requirements, ST offers these devices in different grades of **ECOPACK** packages, depending on their level of environmental compliance. ECOPACK specifications, grade definitions and product status are available at: [www.st.com](http://www.st.com). ECOPACK is an ST trademark.

### 2.1 DO-201 package information

Figure 13. DO-201 package outline

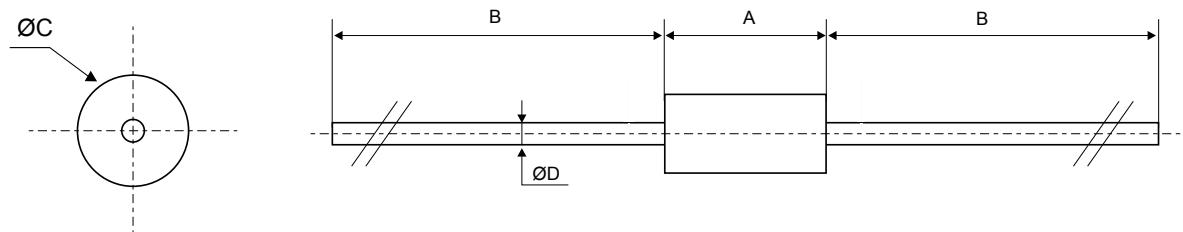

Table 3. DO-201 package mechanical data

Ref.	Dimensions					
	Millimeters			Inches (for reference only)		
	Min.	Typ.	Max.	Min.	Typ.	Max.
A	8.50	-	9.50	0.334	-	0.374
B	25.4	-		1.000	-	
C	4.80	-	5.30	0.189	-	0.209
D	0.96	-	1.06	0.038	-	0.042

Figure 14. Marking layout

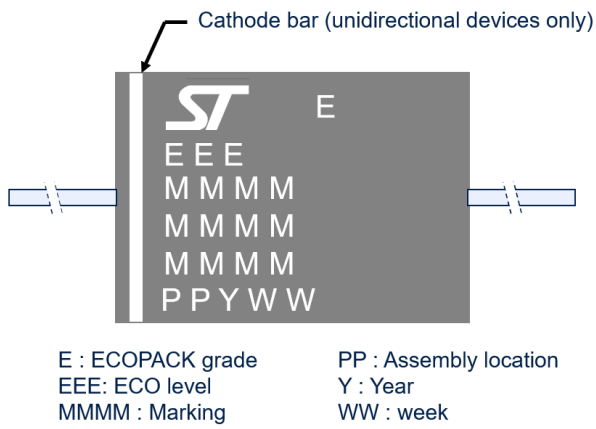

Figure 15. Tape and reel orientation

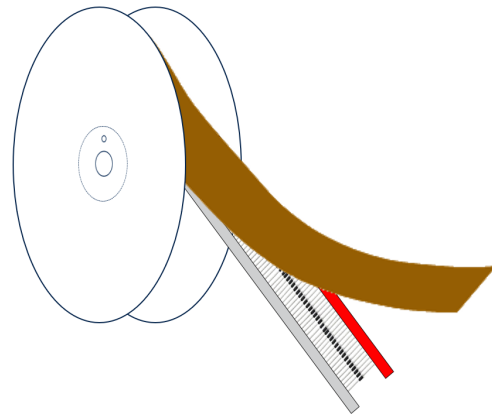

Figure 16. 13" reel dimension values (mm)

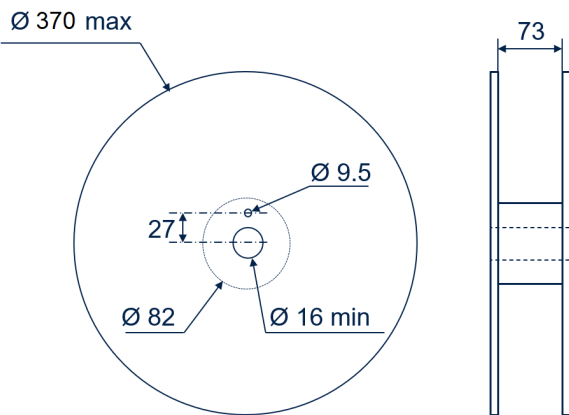

Figure 17. Inner box dimension values (mm)

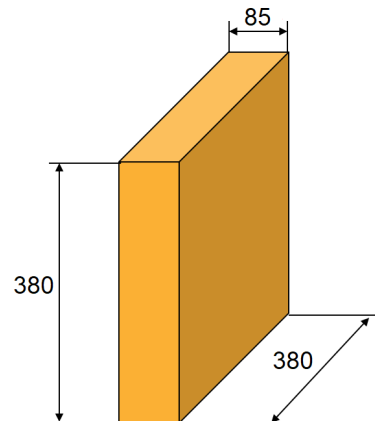

Figure 18. Ammopack dimension values (mm)

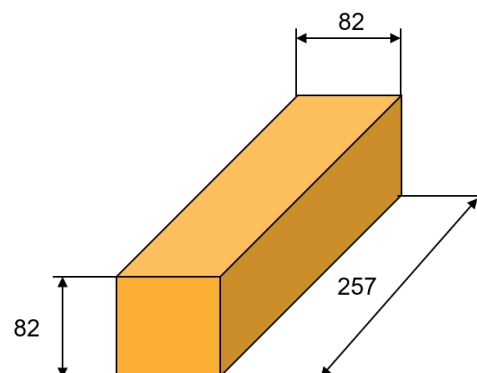
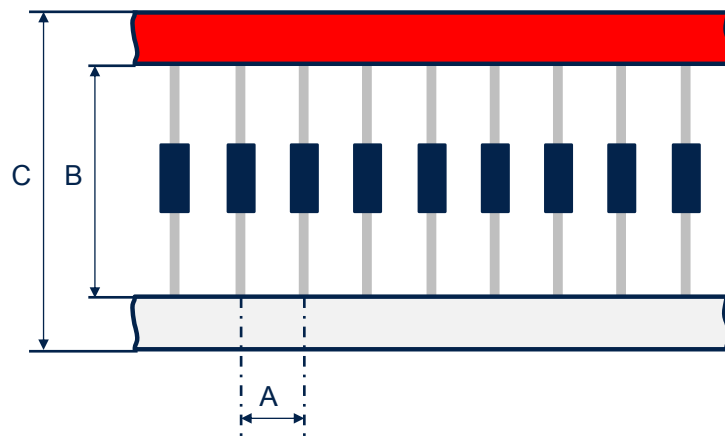

Figure 19. Tape outline



Dimensions are not to scale

Unidirectional components are oriented with red tape on the cathode and white tape on the anode. Bidirectional components have red tape on both sides.

Table 4. Tape dimension values

Ref.	Dimensions		
	Millimeters		
	Min.	Typ.	Max.
A	9.5	10	10.5
B	51	53	55
C	63	65	67



## 2.2 Reflow profile

Figure 20. ST ECOPACK recommended soldering reflow profile for PCB mounting

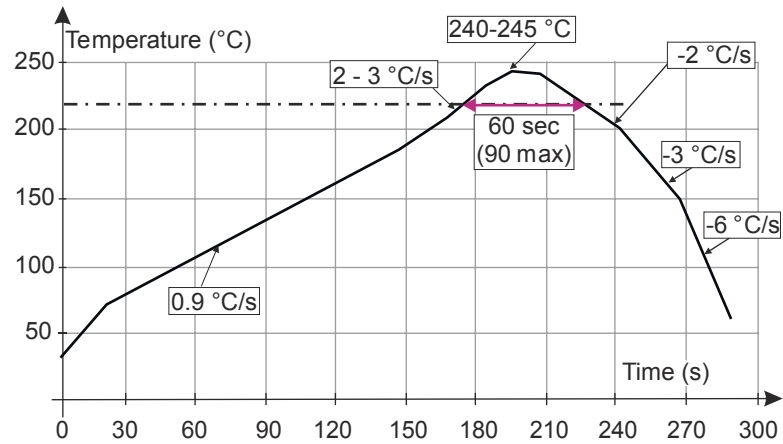

Note: Minimize air convection currents in the reflow oven to avoid component movement. Maximum soldering profile corresponds to the latest IPC/JEDEC J-STD-020.

### 3 Ordering information

**Table 5. Ordering information**

Order code	Marking	Package	Weight	Base qty.	Delivery mode
1.5KExxARL/CARL <sup>(1)</sup>	Equal to order code (without RL suffix)	DO-201	0.876 g	1900	Reel
1.5KExxA/CA	Equal to order code			600	Ammopack

1. Where xx is nominal value of  $V_{BR}$  and A or CA indicates unidirectional or bidirectional version.

## Revision history

**Table 6. Document revision history**

Date	Revision	Changes
Feb -2002	3A	Last issue.
12-Mar-2012	4	Added UL statement, Table 5 and ordering information.
28-Sep-2022	5	Updated package information. Minor text changes.