



2022 PRODUCT CATALOG

www.inrcore.com



INRCORE



iNRCORE

iNRCORE, LLC is a world class manufacturer with 70 years experience supplying catalog and custom magnetic components to the military, commercial aerospace, manned and unmanned space, high reliability industrial, medical, transportation and power-grid infrastructure markets around the world. The company was originally founded as Technitrol in 1947 and products D.S.C.C. qualified products that are listed for MIL-PRF-21038, MIL-PRF-83531 & MIL-PRF-83532 magnetic devices.

iNRCORE's experienced engineering teams offer cutting-edge technical solutions and manufacturing expertise which provide comprehensive production as AS9100D certified facilities located both domestically and off-shore. iNRCORE offers complete design support and qualification testing services to meet your demanding requirements. iNRCORE's award-winning quality and delivery services will help you meet your program's rugged demands - no matter the mission.

© 2021 iNRCORE, LLC



MISSION STATEMENT

- To serve Defense, Aerospace, Space and High-Reliability industry customers with the highest level of service focusing on a relationship with mutual benefits.
- To design and manufacture magnetic solutions exceeding customers' satisfaction in terms of quality, reliability and delivery.
- To be competitive while remaining a world-class source for specialty solutions.

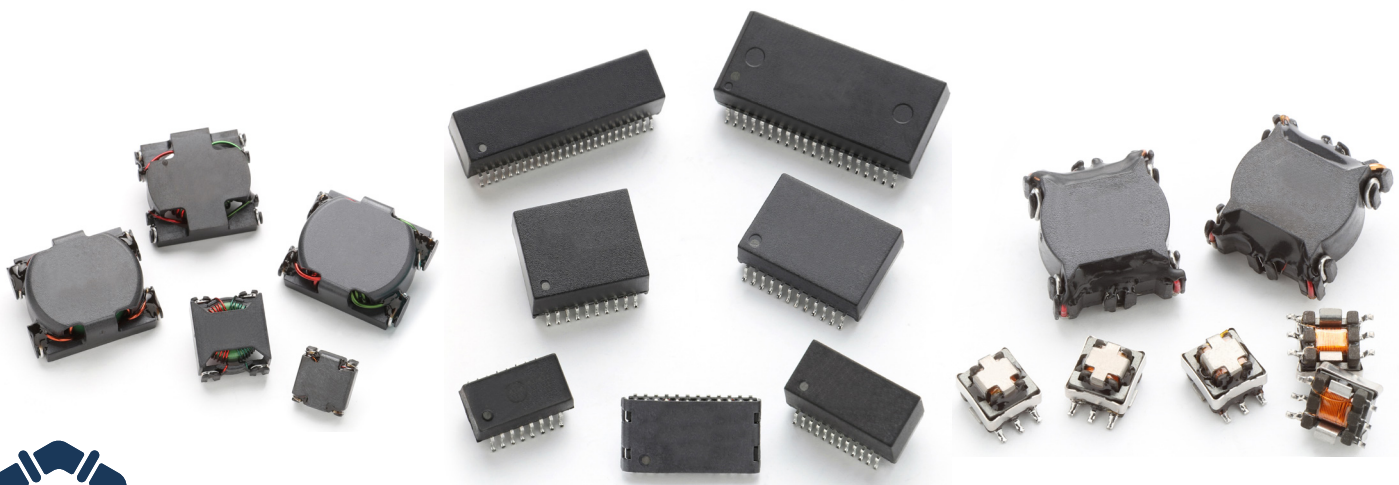

Performance warranty of products offered on this data sheet is limited to the parameters specified. Data is subject to change without notice. Other brand and product names mentioned herein may be trademarks or registered trademarks of their respective owners. © Copyright, 2020. iNRCORE, LLC. All rights reserved.

12/2021

www.iNRCORE.com

TABLE OF CONTENTS

iNRCORE SIGNAL PRODUCTS		4-12
IEEE 1394B Firewire Transceiver Line		4
Copperhead™ Series Transceiver Line Interface Modules (Active)		5
Copperhead™ High Speed Dual Transformers (Dual Passive)		5
Copperhead™ High Speed Single Transformers (Single Passive)		5
Digital Video Isolation Transformers (3G and Standard)		5
SMPTE Digital Video Baluns (3G and Standard)		5
High Frequency Balun Adaptors		6
Ethernet/AFDX (10/100)		7
Ethernet/AFDX (10/100/1000/10000)		8
High Isolation Ethernet (10KV)		9
MIL-STD-1553 Interface Transformers (Non-QPL)		10
MIL-STD-1553 Interface Transformers (Low Profile and Stacked)		11
MIL-STD-1553 Interface Transformers (Low Profile Miniature Series)		11
QPL Series - Qualified to MIL-PRF-21038/27		11
PULSE Transformer/Data Transformer/CAN BUS		12
iNRCORE POWER PRODUCTS		13-18
Toroid Power Inductors (SLED Series)		13
SMT Common Mode Chokes (SLIC Series)		13
SMT Power Inductors (SLIC, HCCI-80) Series		14
SMT Power Inductors (Toroid, SLED Series)		14
SMT Power Inductors (Toroid, POGO Series)		14
SMT Common Mode Inductors (POGO Series)		15
SMT Power Inductors (Shielded Drum Core)		15
SMT Planar Power Inductors		17
High Frequency Planar Power Transformers		18
SMT Current Sense Transformers		20
Audio Transformers		21
Gate Drive Transformers		21
CUSTOM CAPABILITIES & DESIGNER WORKSHEETS		22-25

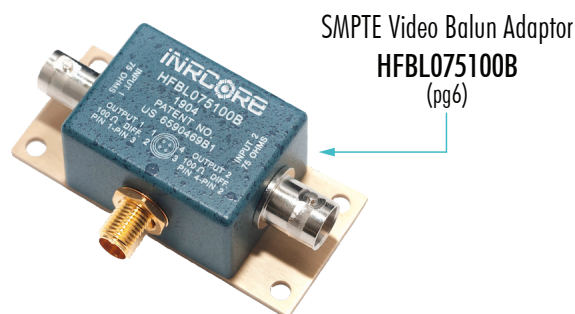

iNRCORE SIGNAL PRODUCTS

iNRCORE has a full line of High-Speed Transformers supporting Ethernet IEEE802.x, AFDX systems, SMPTE Serial Video, Fibre Channel and IEEE1394b applications. A unique line of Line Interface Transceivers supports a wide range of cable impedances and data rates up to 2.125 Gbps. iNRCORE's products have been utilized for a variety of applications, from Fighter Jets to Space programs. iNRCORE continues to offer tin/lead termination finishes for Military, Space and Aerospace applications requiring the highest grade of reliability.

Parts can also be purchased with pure tin lead finishes where RoHS and REACH compliance are required. In addition to providing this full catalog of off-the-shelf products, more than 50% of iNRCORE's business is customizing parts to customer requirements. iNRCORE can provide custom design services, as well as perform specialized screening and qualification testing.

COPPERHEAD™ SERIES TRANSCEIVER LINE INTERFACE MODULES - ACTIVE

High Speed Data and Communications over 100+ Meters of Copper

- ⊗ Military Temperature Range: -55 °C to +125 °C
- ⊗ Low transmit/receive jitter
- ⊗ Low power dissipation; 450 mW typical
- ⊗ ECL or CML logic interface
- ⊗ 1500V Isolation Voltage
- ⊗ Surface Mount - pick-and-place compatible
- ⊗ Withstands infrared and vapor phase soldering 225 °C MAX Temperature

Ordering Information



IEEE 1394B FIREWIRE TRANSCEIVER LINE INTERFACE MODULES

Part Number	Transmitter/Receiver Data Rate (Mb/s)		Transmitter Differential Signal Level - V _{OUT} (mV)			Total Power Dissipation (mW) TYP	Receive Turns Ratio TYP	Receive Primary Inductance - Lm (uH) MIN	Return Loss Insertion (dB) MAX	Transmit/Receive Return Loss (dB) MIN	Package L/W/H (in.)	Data Sheet*	IEEE 1394B Speed
	MIN	MAX	MIN	TYP	MAX								
TM1062TXDUA	246	1062	1350	1400	1500	232	1:1	4.5	-2	-12	0.800/0.400/0.200	M103	S200-S800
TM1062TXHUA	246	1062	1350	1400	1500	232	1:1	4.5	-2	-12	0.510/0.300/0.140	M103	S200-S800
TM1062TX3DUA	246	1062	1350	1400	1500	700	1:1	4.5	-2	-12	0.800/0.400/0.185	M103	S200-S800
TM125TXHUA	98	246	1350	1400	1500	232	1:1	40	-2	-12	0.510/0.300/0.140	M186	S100-S200
TM1062DUXB	246	1062	1350	1400	1500	232	1:1	4.5	-2	-12	0.800/0.400/0.200	M186	S200-S800
TM1062HUXB	246	1062	1350	1400	1500	232	1:1	4.5	-2	-12	0.510/0.300/0.140	M186	S200-S800
TM1062DU3XB	246	1062	1350	1400	1500	700	1:1	4.5	-2	-12	0.800/0.400/0.200	M186	S200-S800
TM125TXHUA	98	246	1350	1400	1500	232	1:1	44	-2	-12	0.510/0.300/0.140	M186	S100-S200

* Parts listed on datasheet M103 are manufactured in the United States. Datasheet M186 contains equivalent parts manufactured in China.

NOTES:

- Applications: Fibre Channel, Gigabit Ethernet, SONET, HDTV, IEEE 1394B, SMPTE.
- iNRCORE's standard lead finish is tin/lead (Sn63/Pb37). Parts can be ordered Non-lead by adding the suffix "NL" to the part number (i.e. TM1062DUXBNL).
- To order in Tape & Reel packaging, add the suffix "T" to the part number (i.e. TM1062DUXBT).



COPPERHEAD™ HIGH SPEED DUAL TRANSFORMERS - PASSIVE

Part Number	Package L/W/H (in.)	Turns Ratio (±5%)	Primary Inductance (µH) MIN	Rise Time (ps: MAX @20%-80%)	DC Resistance (Ω) MAX	HiPot (Vrms) MIN	Insertion Loss (dB) MAX	Application Nominal Bit Rate (Mbps)	Data Sheet
T-330SCT	0.500/0.435/0.180	1CT:1CT	26	350	0.20	1500	-1.5 (15 - 165 MHz)	265.6 (quarter speed)	M105
T-531SCT	0.500/0.375/0.235	1CT:1CT	7.5	325	0.20	1500	-2.0 (50 - 265 MHz)	531 (half speed)	M105
T-1062SCT	0.500/0.435/0.180	1CT:1CT	3.75	280	0.20	1500	-2.0 (100 - 531 MHz)	1062.50 (full speed)	M105
T-1250SCT	0.500/0.435/0.180	1CT:1CT	3.75	280	0.20	1500	-2.0 (125 - 650 MHz)	1,250 (Gigabit Ethernet)	M105
T-1485SCT	0.500/0.435/0.180	1CT:1CT	3.75	280	0.20	1500	1,485 (SMPTE)	1,485 (SMPTE)	M105
T-3200SCT	0.500/0.375/0.235	1CT:1CT	0.70	280	0.20	1500	-4.5 (500 - 1600 MHz)	3,200	M105

COPPERHEAD™ HIGH SPEED SINGLE TRANSFORMERS - PASSIVE

Part Number	Package L/W/H (in.)	Turns Ratio (±5%)	Primary Inductance (µH) MIN	Rise Time (ps: MAX @20%-80%)	DC Resistance (Ω) MAX	HiPot (Vrms) MIN	Insertion Loss (dB) MAX	Application Nominal Bit Rate (Mbps)	Data Sheet
T-330ACT	0.230/0.265/0.215	1CT:1CT	26	350	0.20	1500	-1.5 (15 - 165 MHz)	265.5 (quarter speed)	M131
T-531ACT	0.230/0.265/0.215	1CT:1CT	7.5	325	0.20	1500	-2.0 (100 - 265 MHz)	531 (half speed)	M131
T-1062ACT	0.230/0.265/0.215	1CT:1CT	3.75	280	0.20	1500	-2.0 (100 - 531 MHz)	1062.5 (full speed)	M131
T-1250ACT	0.230/0.265/0.215	1CT:1CT	3.75	280	0.20	1500	-2.0 (200 - 620 MHz)	1,250 (Gigabit Ethernet)	M131
T-1485ACT	0.230/0.265/0.215	1CT:1CT	3.75	280	0.20	1500	-2.0 (200 - 742.5 MHz)	1,485 (SMPTE)	M131

NOTES:

- Dual Transformers are designed specifically for Point-to-Point Communication using STP, QUADRAX or TWINAX cable (comparable with 50,75,100 & 150Ω cable)
- Applications: Fibre Channel, Gigabit Ethernet, SONET, HDTV, IEEE 1394B, SMPTE.
- INRCORE's standard lead finish is tin/lead (Sn63/Pb37). Parts can be ordered Non-Lead by adding "NL" to the part number (i.e. T-1250ACTNL).
- To order in Tape & Reel packaging, add the suffix "T" to the part number (i.e. T-330ACTT)

HIGH-FREQUENCY SMT BALUNS

Part Number	Impedance Unbalanced (Ω)	Impedance Balanced (Ω)	Insertion Loss 1.0 MHz - 1.485Gbps (dB) MAX	Insertion Loss 1.0 MHz - 1.485Gbps (dB) MIN	Data Sheet
T-050078	50	78	-2	12	M132
T-050100	50	100	-2	12	M132
T-050150	50	150	-2	12	M132
T-075100	75	100	-2	12	M132

- Designed for standard test equipment with SMA connectors. Wide bandwidth: 1.0 MHz to 1.2 GHz.

SMPT E DIGITAL VIDEO BALUNS – 3G AND STANDARD (1.485Gbps)

Part Number	Package L/W/H (in.)	Data Rate (Gbps)	Impedance Unbalanced (Ω)	Impedance Balanced (Ω)	Insertion Loss @1.5GHz (dB) MAX	Return Loss @1.5GHz (dB) MIN	Data Sheet
TA-0751003G	0.290/0.240/0.150	2.973	75	100	-2.0	12	M551
TA-0751503G	0.290/0.240/0.150	2.973	75	150	-2.0	10	M551
TA-0501003G	0.290/0.240/0.150	2.973	50	100	-2.0	10	M551
TA-075100G	0.290/0.240/0.150	1.485	75	100	-2.0	12	M551
TA-075150G	0.290/0.240/0.150	1.485	75	150	-2.0	10	M551
TA-050100G	0.290/0.240/0.150	1.485	50	100	-2.0	10	M551

SMPT E DIGITAL VIDEO ISOLATION TRANSFORMERS – 3G (2.973Gbps)

Part Number	Package L/W/H (in.)	Data Rate (Gbps)	Impedance Unbalanced (Ω)	Impedance Balanced (Ω)	Insertion Loss @1.5GHz (dB) MAX	Isolation (Hi-Pot) (Vrms) MAX	Data Sheet
TA-0750753G	0.290/0.240/0.150	2.973	75	75	-6.0	1500	M558



INSTRUMENTATION BALUN ADAPTERS

Part Number	Impedance Unbalanced (Ω)	Impedance Balanced (Ω)	Insertion Loss (dB)	Return Loss 1.0MHz - 1.2GHz (dB)	Data Sheet
			MAX	MIN	
HFB050150	50	150	-2	15	M100
HFB050100	50	100	-2	15	M100

- Transforms 150 Ω or 100 Ω balanced differential signal, to 50 Ω single-ended signal.
- Designed for standard test equipment with SMA connectors. Wide bandwidth: 1.0 MHz to 1.2 GHz.

SMPT E VIDEO BALUN ADAPTORS - STANDARD (1.485Gbps)

Part Number	Impedance Unbalanced (Ω)	Impedance Balanced (Ω)	Insertion Loss (dB)	Jitter Dj (pSec)	Bracket	Data Sheet
			MAX	MAX		
HFB075100A	75	100	-2	110	No	M146
HFB075100B	75	100	-2	110	No	M146
HFB075150A	75	150	-2	110	No	M146
HFB075150B	75	150	-2	110	No	M146
HFBLO75100A	75	100	-2	110	Yes	M146
HFBLO75100B	75	100	-2	110	Yes	M146
HFBLO75150A	75	150	-2	110	Yes	M146
HFBLO75150B	75	150	-2	110	Yes	M146
HFBM075100B	75	100	-2	110	Yes	M147
HFBM075100C *	75	100	-2	110	Yes	M147
HFBM075100S **	75	100	-2	110	Yes	M305
HFBM075100L	75	100	-2	110	Yes	M265
HFB075100D	75	100	-2	110	Yes	M283

- Transforms 100 Ω or 150 Ω balanced differential signal to 75 Ω , grounded, unbalanced signal.
- Designed for SMPTE-292M. HDTV application at 1.485Gbps data rate.

* HFBM075100C - 75 Ω Connectors: TriaxS Ω , Trompeter BJ770
 ** HFBM075100S - 75 Ω Connectors: BNC

SMPT E VIDEO BALUN ADAPTORS - 3G

Part Number	Impedance Unbalanced (Ω)	Impedance Balanced (Ω)	Insertion Loss (dB)	Jitter Dj (pSec)	Bracket	Data Sheet
			MAX	MAX		
HFB3G075100A	75	100	-6.50	65	No	M416
HFB3G075100B	75	100	-6.50	65	No	M416
HFB3GLO75100A	75	100	-6.50	65	Yes	M416
HFB3GLO75100B	75	100	-6.50	65	Yes	M416
HFB3G075150A	75	150	-6.50	65	No	M416
HFB3G075150B	75	150	-6.50	65	No	M416
HFB3GLO75150A	75	150	-6.50	65	Yes	M416
HFB3GLO75150B	75	150	-6.50	65	Yes	M416

- Transforms 100 Ω or 150 Ω balanced differential signal to 75 Ω , grounded, unbalanced signal.
- Designed for SMPTE-424M/425M, 2,973Gbps.

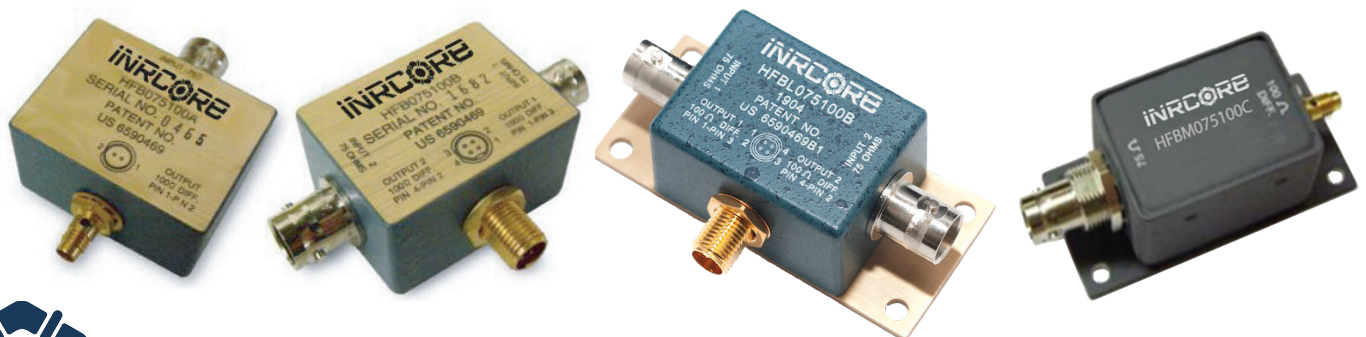



ETHERNET / AFDX

10/100Base - TX

Number of Ports	Part Number	Turns Ratio	Configuration		Package Style	Size L/W/H (in.)	Data Sheet
			RX	TX			
Single	100B-1001	1CT:1CT	T, C	T, C, S	12-pin SMT	0.630/0.470/0.200	M101
	100B-1001X	1CT:1CT	T, C	T, C, S	12-pin SMT	0.630/0.470/0.200	M101
	100B-1001F	1CT:1CT	T, C	T, C, S	12-pin SMT	0.630/0.470/0.200	M101
	100B-1001FX	1CT:1CT	T, C	T, C, S	12-pin SMT	0.630/0.470/0.200	M101
	100B-1003	1CT:1CT	T, C	T, C	16-pin SMT	0.500/0.265/0.235	M101
	100B-1003X	1CT:1CT	T, C	T, C	16-pin SMT	0.500/0.265/0.235	M101
	100B-1018	1CT:1CT	T, C	T, C, S	12-pin SMT	0.583/0.470/0.180	M189
	100B-1018X	1CT:1CT	T, C	T, C, S	12-pin SMT	0.583/0.470/0.180	M189
	100B-1027	1CT:1CT	T, C	T, C, S	16-pin SMT	1.00/0.390/0.235	M197
	100B-1027X	1CT:1CT	T, C	T, C, S	16-pin SMT	1.00/0.390/0.235	M197
	100B-1035	1CT:1CT	T, C	T, C	12-pin SMT	0.500/0.347/0.088	M316
	100B-1051	1CT:1CT	T, C	T, C	24-pin SMT	0.590/0.520/0.155	M440
	100B-1054X	1CT:1CT	T, C	T, C	16-pin SMT	0.500/0.358/0.236	M441
Dual	100B-2002	1CT:1CT	T, C	T, C	24-pin SMT	0.518/0.595/0.241	M110
	100B-2002X	1CT:1CT	T, C	T, C	24-pin SMT	0.518/0.595/0.241	M110
	100B-2002F	1CT:1CT	T, C	T, C	24-pin SMT	0.518/0.595/0.241	M110
	100B-2002FX	1CT:1CT	T, C	T, C	24-pin SMT	0.518/0.595/0.241	M110
Quad	100B-4005	1CT:1CT	T, C	T, C	40-pin SMT	1.125/0.480/0.280	M203
	100B-4005X	1CT:1CT	T, C	T, C	40-pin SMT	1.120/0.480/0.280	M203
	100B-4005F	1CT:1CT	T, C	T, C	40-pin SMT	1.125/0.480/0.280	M203
	100B-4005FX	1CT:1CT	T, C	T, C	40-pin SMT	1.120/0.480/0.280	M203
	100B-4009	1CT:1CT	T, C	T, C	40-pin SMT	1.125/0.480/0.280	M190
	100B-4009X	1CT:1CT	T, C	T, C	40-pin SMT	1.125/0.480/0.280	M190
	100B-4009F	1CT:1CT	T, C	T, C	40-pin SMT	1.125/0.480/0.280	M190
	100B-4009FX	1CT:1CT	T, C	T, C	40-pin SMT	1.125/0.480/0.280	M190
	100B-4011	1CT:1CT	T, C	T, C	40-pin SMT	1.125/0.480/0.280	M151
	100B-4011X	1CT:1CT	T, C	T, C	40-pin SMT	1.125/0.480/0.280	M151
	100B-4011F	1CT:1CT	T, C	T, C	40-pin SMT	1.125/0.480/0.280	M151
	100B-4011FX	1CT:1CT	T, C	T, C	40-pin SMT	1.125/0.480/0.280	M151
	100B-4018	1CT:1CT	T, C	T, C	40-pin SMT	1.110/0.630/0.225	M448
	100B-4019	1CT:1CT	T, C	T, C	40-pin SMT	1.080/0.630/0.226	M449
100B-4020	1CT:1CT		C, T, C	C, T, C	40-pin SMT	1.090/0.360/0.236	M307

- iNRCORE's standard lead finish is Tin/Lead (Sn63/Pb37). Parts can be ordered Non-Lead by adding "NL" to the part number (i.e. 100B-2002XNL).
- To order in Tape & Reel packaging, add the suffix "T" to the part number (i.e. 100B-4009FT)

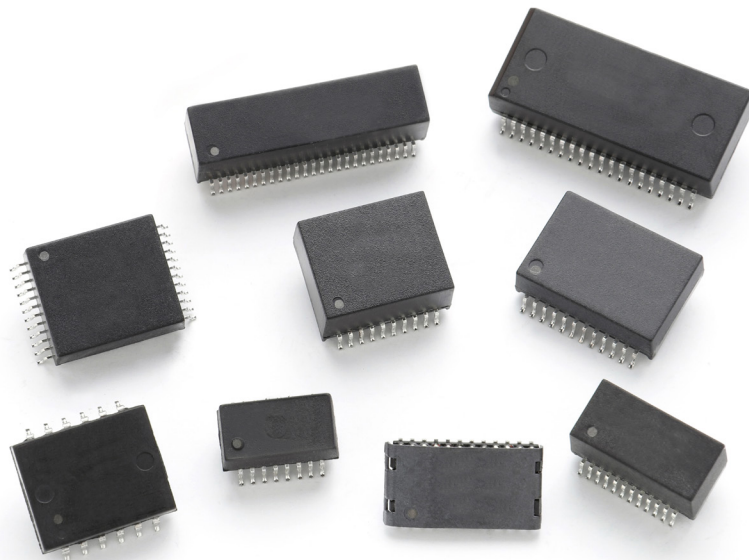

iNRCORE							
ETHERNET / AFDX							
1000Base-T / 10GBase-T							
Number of Ports	Part Number	Turns Ratio	Configuration		Package Style	Size L/W/H (in.)	Data Sheet
			RX	TX			
Single	1000B-5001	1CT:1CT	T, C, S	T, C, S	24-pin SMT	0.695/0.635/0.230	M1061
	1000B-5001X	1CT:1CT	T, C, S	T, C, S	24-pin SMT	0.695/0.635/0.230	M1061
	1000B-5001F	1CT:1CT	T, C, S	T, C, S	24-pin SMT	0.695/0.635/0.230	M1061
	1000B-5001FX	1CT:1CT	T, C, S	T, C, S	24-pin SMT	0.695/0.635/0.230	M1061
	1000B-5002	1CT:1CT	T, C	T, C	24-pin SMT	0.695/0.635/0.230	M106
	1000B-5002X	1CT:1CT	T, C	T, C	24-pin SMT	0.695/0.635/0.230	M106
	1000B-5002F	1CT:1CT	T, C	T, C	24-pin SMT	0.695/0.635/0.230	M106
	1000B-5002FX	1CT:1CT	T, C	T, C	24-pin SMT	0.695/0.635/0.230	M106
	1000B-5004	1CT:1CT	T, C, S	T, C, S	24-pin SMT	0.705/0.490/0.190	M428
	1000B-5009	1CT:1CT	T	T	24-pin SMT	0.600/0.430/0.340	M160
	1000B-5009X	1CT:1CT	T	T	24-pin SMT	0.600/0.430/0.340	M160
	1000B-5010 (PoE)	1CT:1CT	T, C, S	T, C, S	24-pin SMT	0.690/0.480/0.225	M290
	1000B-5010X (PoE)	1CT:1CT	T, C, S	T, C, S	24-pin SMT	0.690/0.480/0.225	M290
	1000B-5012	1CT:1CT	T	T	24-pin SMT	0.735/0.518/0.241	M160
	1000B-5012X	1CT:1CT	T	T	24-pin SMT	0.735/0.518/0.241	M160
	1000B-5016	1CT:1CT	T	T	24-pin SMT	0.600/0.405/0.163	M160
	1000B-5017	1CT:1CT	T, C	T, C	24-pin SMT	0.715/0.480/0.260	M429
	1000B-5017F	1CT:1CT	T, C	T, C	24-pin SMT	0.715/0.480/0.260	M429
	1000B-5026F	1CT:1CT	T, C	T, C	24-pin SMT	0.705/0.480/0.180	M430
	1000B-5027 (PoE)	1CT:1CT	T, C, S	T, C, S	24-pin SMT	0.695/0.480/0.180	M238
	1000B-5027X (PoE)	1CT:1CT	T, C, S	T, C, S	24-pin SMT	0.695/0.480/0.180	M238
	1000B-5028X	1CT:1CT	T	T	24-pin SMT	0.600/0.300/0.163	M431
	1000B-5028FX	1CT:1CT	T	T	24-pin SMT	0.600/0.300/0.163	M431
	1000B-5029	1CT:1CT	T, C	T, C	24-pin SMT	0.700/0.620/0.185	M285
	1000B-5029X	1CT:1CT	T, C	T, C	24-pin SMT	0.700/0.620/0.185	M285
	1000B-5033	1CT:1CT	T, C	T, C	24-pin SMT	0.600/0.430/0.340	M433
	1000B-5033X	1CT:1CT	T, C	T, C	24-pin SMT	0.600/0.430/0.340	M433
	1000B-5035	1CT:1CT	T, C, S	T, C, S	24-pin SMT	0.736/0.537/0.225	M434
	1000B-5036 (PoE)	1CT:1CT	T, C	T, C	24-pin SMT	0.725/0.490/0.265	M435
	1000B-5037 (PoE)	1CT:1CT	T, C	T, C	24-pin SMT	0.725/0.633/0.410	M436
	1000B-5042	1CT:1CT	T, C	T, C	24-pin SMT	0.510/0.520/0.155	M437
	1000B-5045X	1CT:1CT	T, C	T, C	24-pin SMT	0.725/0.490/0.265	M438
	1000B-5046x	1CT:1CT	T, C	T, C	24-pin SMT	0.725/0.490/0.265	M439
	10GB-6001	1CT:1CT	T, C	T, C	24-pin SMT	0.700/0.630/0.235	M375
	10GB-6006	1CT:1CT	T, C	T, C	24-pin SMT	0.700/0.630/0.235	M555
	10GB-6007	1CT:1CT	T, C	T, C	24-pin SMT	0.790/0.760/0.100	M553
	10GB-6009	1CT:1CT	T, C	T, C	30-pin SMT	0.705/0.615/0.295	M562
	10GB-6010	1CT:1CT	C, T	C, T	24-pin SMT	0.547/0.605/0.225	M567
	10GB-6011 (POE)	1CT:1CT	C, T	C, T	24-pin SMT	0.725/0.630/0.265	M564
	10GB-6012 (POE+)	1CT:1CT	C, T	C, T	24-pin SMT	0.725/0.643/0.410	M565
	10GB-6013 (POE++)	1CT:1CT	C, T	C, T	24-pin SMT	0.725/0.643/0.410	M566
	10GB-6014	1CT:1CT	T, C	T, C	24-pin SMT	0.547/0.605/0.255	M568
Dual	1000B-5003	1CT:1CT	T, C	T, C	50-pin SMT	1.100/0.430/0.340	M106
	1000B-5003X	1CT:1CT	T, C	T, C	50-pin SMT	1.100/0.430/0.340	M106
	1000B-5003F	1CT:1CT	T, C	T, C	50-pin SMT	1.100/0.430/0.340	M106
	1000B-5003FX	1CT:1CT	T, C	T, C	50-pin SMT	1.100/0.430/0.340	M106
	1000B-5014	1CT:1CT	T, C, S	T, C, S	48-pin SMT	1.100/0.610/0.290	M160
	1000B-5014X	1CT:1CT	T, C, S	T, C, S	48-pin SMT	1.100/0.610/0.290	M160
	1000B-5020	1CT:1CT	T, C	T, C	48-pin SMT	0.100/0.610/0.290	M286
	1000B-5020X	1CT:1CT	T, C	T, C	48-pin SMT	0.100/0.610/0.290	M286

- iNRCORE's standard lead finish is tin/lead (Sn63/Pb37). Parts can be ordered Non-Lead by adding "NL" to the part number (i.e. 1000B-5003NL).
- To order in Tape & Reel packaging, add the suffix "T" to the part number (i.e. 1000B-5002FXT)
- T = Transformer, C = Choke, S = Shunt inductor

- Standard Operating Temperature: -40°C to +85°C
- Extended Operating Temperature (suffix "X"): -55°C to +125°C
- Parts compliant to IEEE 802.3 standard
- PoE = Power over Ethernet Per IEEE 802.3af, 15 W
PoE+ = 30W
PoE++ = 60W



ETHERNET / AFDX

10/100Base - TX

Part Number	Insertion Loss (dB MAX)				Return Loss (dB MIN)						Crosstalk (dB MIN)				Differential to Common Mode Rejection (dB MIN)				Isolation (K VAC)	Data Sheet
	0.10 - 30 MHz	60 MHz	80 MHz	100 MHz	5 MHz	30 MHz	50 MHz	60 MHz	80 MHz	100 MHz	1 MHz	30 MHz	60 MHz	100 MHz	30 MHz	60 MHz	100 MHz	200 MHz		
X-1644	-1.00	-2.0	-2.50	-4.00	-18	-9	-5.50	-4.50	-3.00	-2.0	-45	-30	-27	-25	-36	-32	-30	-25	10	M215
X-1697	-1.50	-3.0	-3.50	-4.50	-18	-8	-5.50	-4.50	-3.30	-2.0	-45	-30	-27	-25	-36	-32	-30	-25	10	M514
100B-1014	-1.10	-1.0		-1.40	-20	-13	-10	-9	-7		-50	-40	-40	-35	-42	-37	-35	-35	6	M510
100B-1021	-1.00	-2.0	-3.00	-4.00	-18	-9	-5.50	-4.50	-3	-2.0	-45	-30	-27	-25	-36	-32	-30	-25	8	M511
100B-1044	-1.00	-1.0	-1.00	-1.00	-12	-12	-12	-12	-10	-8.0	-45	-30	-27	-25	-36	-32	-30	-25	6	M512

- INRCORE's standard lead finish is tin/lead (Sn63/Pb37). Parts can be ordered Non-Lead by adding "NL" to the part number (i.e. 100B-1014NL).
- To order in Tape & Reel packaging, add the suffix "T" to the part number (i.e. 100B-1014T).

Mechanicals

Electrical Schematics

X-1644

Dimensions: inch [mm]
Tolerance (unless otherwise specified): ±0.010 [0.25]

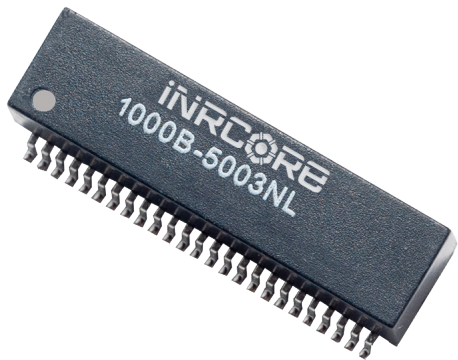
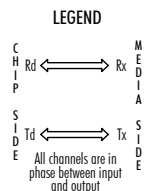
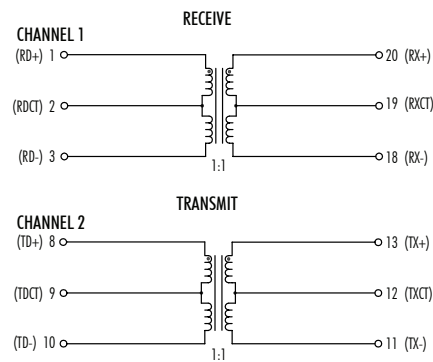
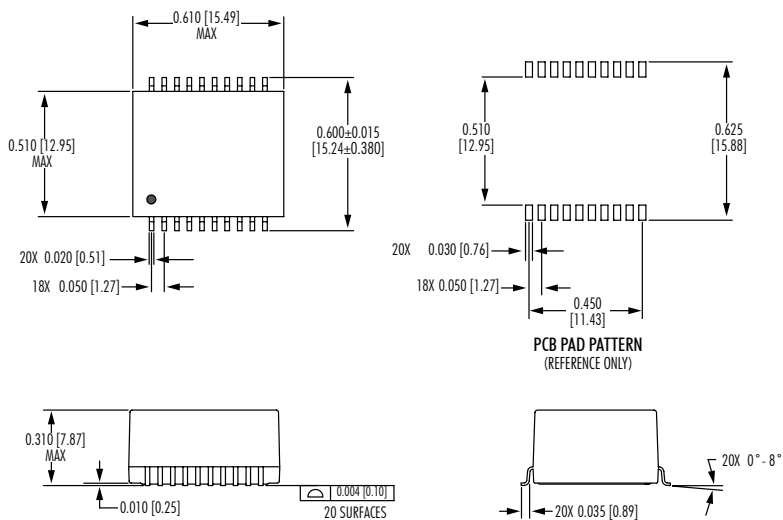

MIL-STD-1553 INTERFACE TRANSFORMERS

Non-QPL

Part Number	Turns Ratio (±3%)	Impedance MIN (W)	Package Size L/W/H (in.)	Data Sheet	Part Number	Turns Ratio (±3%)	Impedance MIN (W)	Package Size L/W/H (in.)	Data Sheet
FL1553-1	1CT:1CT/1CT:0.707CT	4000	0.630/0.630/0.155	M227	STQ1553-3	1.25:1/1.66:1	4000	0.630/0.630/0.340	M230
GL1553-1	1CT:1CT/1CT:0.707CT	4000	0.630/0.630/0.155	M227	STQ1553-5	1:2.12/1:1.50	4000	0.630/0.630/0.340	M230
TL1553-1	1CT:1CT/1CT:0.707CT	4000	0.630/0.630/0.155	M226	STQ1553-45	1.50/1:1.79	4000	0.630/0.630/0.340	M230
FL1553-2	1.40CT:1CT/2CT:1CT	7200	0.630/0.630/0.155	M227	SFQ1553-1	1:1/1:0.707	4000	0.630/0.630/0.340	M231
GL1553-2	1.40CT:1CT/2CT:1CT	7200	0.630/0.630/0.155	M227	SGQ1553-1	1:1/1:0.707	4000	0.630/0.630/0.340	M231
TL1553-2	1.40CT:1CT/2CT:1CT	7200	0.630/0.630/0.155	M226	SFQ1553-2	1.40:1/2:1	7200	0.630/0.630/0.340	M231
FL1553-3	1.25CT:1CT/1.66CT/1CT	4000	0.630/0.630/0.155	M227	SGQ1553-2	1.40:1/2:1	7200	0.630/0.630/0.340	M231
GL1553-3	1.25CT:1CT/1.66CT/1CT	4000	0.630/0.630/0.155	M227	SFQ1553-3	1.25:1/1.66:1	4000	0.630/0.630/0.340	M231
TL1553-3	1.25CT:1CT/1.66CT/1CT	4000	0.630/0.630/0.155	M226	SGQ1553-3	1.25:1/1.66:1	4000	0.630/0.630/0.340	M231
FL1553-5	1CT:2.12CT/1CT:1.50CT	4000	0.630/0.630/0.155	M227	SFQ1553-5	1:2.12/1:1.50	4000	0.630/0.630/0.340	M231
GL1553-5	1CT:2.12CT/1CT:1.50CT	4000	0.630/0.630/0.155	M227	SGQ1553-5	1:2.12/1:1.50	4000	0.630/0.630/0.340	M231
TL1553-5	1CT:2.12CT/1CT:1.50CT	4000	0.630/0.630/0.155	M226	SFQ1553-45	1:2.50/1:1.79	4000	0.630/0.630/0.340	M231
FL1553-45	1CT:2.50CT/1CT:1.79CT	4000	0.630/0.630/0.155	M227	SGQ1553-45	1:2.50/1:1.79	4000	0.630/0.630/0.340	M231
GL1553-45	1CT:2.50CT/1CT:1.79CT	4000	0.630/0.630/0.155	M227	SLQF1553-1	1:1/1.40:1	4000	0.630/0.630/0.280	M234
TL1553-45	1CT:2.50CT/1CT:1.79CT	4000	0.630/0.630/0.155	M226	SLQF1553-2	1.40:1/2:1	7200	0.630/0.630/0.280	M234
DFL1553-1	1CT:1CT/1CT:0.707CT	4000	0.930/0.630/0.155	M229	SLQF1553-3	1.25:1/1.66:1	4000	0.630/0.630/0.280	M234
DGL1553-1	1CT:1CT/1CT:0.707CT	4000	0.930/0.630/0.155	M229	SLQF1553-5	1:2.12/1:1.50	4000	0.630/0.630/0.280	M234
DTL1553-1	1CT:1CT/1CT:0.707CT	4000	0.930/0.630/0.155	M228	SLQF1553-45	1:2.5/1:1.79	4000	0.630/0.630/0.280	M234
DFL1553-2	1.40CT:1CT/2CT:1CT	7200	0.930/0.630/0.155	M229	SLQG1553-1	1:1/1.4:1	4000	0.630/0.630/0.280	M234
DGL1553-2	1.40CT:1CT/2CT:1CT	7200	0.930/0.630/0.155	M229	SLQG1553-2	1.4:1/2:1	7200	0.630/0.630/0.280	M234
DTL1553-2	1.40CT:1CT/2CT:1CT	7200	0.930/0.630/0.155	M228	SLQG1553-3	1.25:1/1.66:1	4000	0.630/0.630/0.280	M234
DFL1553-3	1.25CT:1CT/1.66CT:1CT	4000	0.930/0.630/0.155	M229	SLQG1553-5	1:2.12/1:1.50	4000	0.630/0.630/0.280	M234
DGL1553-3	1.25CT:1CT/1.66CT:1CT	4000	0.930/0.630/0.155	M229	SLQG1553-45	1:2.50/1:1.79	4000	0.630/0.630/0.280	M234
DTL1553-3	1.25CT:1CT/1.66CT:1CT	4000	0.930/0.630/0.155	M228	SLQT1553-1	1:1/1.4:1	4000	0.630/0.630/0.280	M234
DFL1553-5	1CT:2.12CT/1CT:1.50CT	4000	0.930/0.630/0.155	M229	SLQT1553-2	1.4:1/2:1	7200	0.630/0.630/0.280	M234
DGL1553-5	1CT:2.12CT/1CT:1.50CT	4000	0.930/0.630/0.155	M229	SLQT1553-3	1.25:1/1.66:1	4000	0.630/0.630/0.280	M234
DTL1553-5	1CT:2.12CT/1CT:1.50CT	4000	0.930/0.630/0.155	M228	SLQT1553-5	1:2.12/1:1.50	4000	0.630/0.630/0.280	M234
DFL1553-45	1CT:2.50CT/1CT:1.79CT	4000	0.930/0.630/0.155	M229	SLQT1553-45	1:2.50/1:1.79	4000	0.630/0.630/0.280	M234
DGL1553-45	1CT:2.50CT/1CT:1.79CT	4000	0.930/0.630/0.155	M229	X-1584	1:1.79	3000	0.500/0.350/0.172	M157
DTL1553-45	1CT:2.50CT/1CT:1.79CT	4000	0.930/0.630/0.155	M228	X-1596	1:2.50	3000	0.500/0.350/0.172	M157
STQ1553-1	1CT:1CT/1CT:0.707CT	4000	0.630/0.630/0.340	M230	Q1553-71**	1:3/1:2.15	4000	0.625/0.625/0.250	M128
STQ1553-2	1.40CT:1CT/2CT:1CT	7200	0.630/0.630/0.340	M230	SMQ1553-70**	1:3/1:2.15	4000	0.625/0.625/0.250	M128

*** Choose 1 of 3 Operating Temperature Ranges:**

Operating Temperature	Flat Pack Prefix	Gull Wing Prefix	Thru-Hole Prefix
0°C to +70°C	FLC	GLC	TLC
-40°C to +85°C	FLN	GLN	TLN
-55°C to +125°C	FL	GL	TL

Part Number Prefix - Package Types	
FL	Flat Pack Package
GL	Gull Wing Package
TL	Thru-Hole Package
DFL	Dual-Ratio, Dual Interface, Flat Pack Package
DGL	Dual-Ratio, Dual Interface, Gull Wing Package
DTL	Dual-Ratio, Dual Interface, Thru-Hole Package
SFQ	Stacked Dual-Ratio, Dual Interface, Flat Pack Package
SGQ	Stacked Dual-Ratio, Dual Interface, Gull Wing Package
STQ	Stacked Dual-Ratio, Dual Interface, Thru-Hole Package
SLQF	Stacked/Low Profile, Dual-Ratio, Dual Interface, Flat Pack Package
SLQG	Stacked/Low Profile, Dual-Ratio, Dual Interface, Gull Wing Package
SLQT	Stacked/Low Profile, Dual-Ratio, Dual Interface, Thru-Hole Package

- Designed and built to conform with MIL-PRF-21038/27 requirements.
- Custom capabilities are available - See Temperature Range options
- Parts can be built and screened to Space NASA EEE-INST-002 requirements.

**For use with 3.3VDC Transceivers

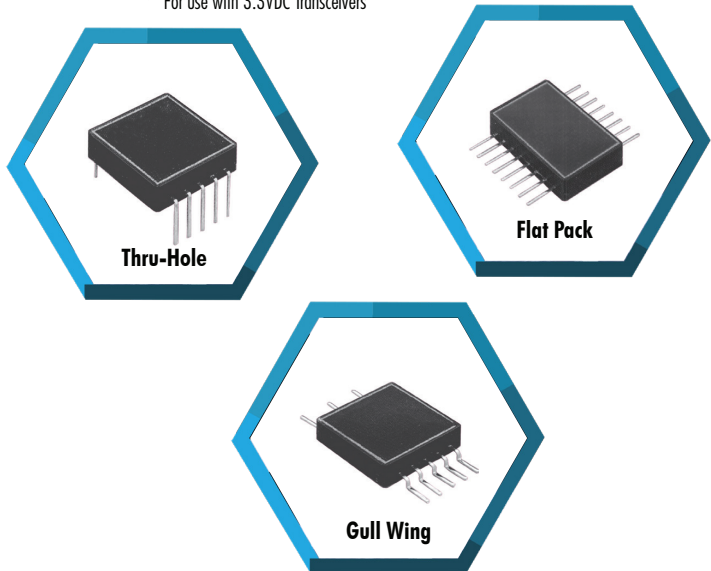

MIL-STD-1553 INTERFACE TRANSFORMERS (continued)

Interface Transformers - COTS Series				
Part Number	Turns Ratio ($\pm 3\%$)	Impedance MIN (W)	Package Size L/W/H (in.)	Data Sheet
X1553-1	1:1/1:0.707	4000	0.625/0.625/0.250	M233
X1553-2	1.40:1/2:1	7200	0.625/0.625/0.250	M233
X1553-3	1.25:1/1.66:1	4000	0.625/0.625/0.250	M233
X1553-5	1:2.12/1.5:1	4000	0.625/0.625/0.250	M233
X1553-45	1:2.50/1:1.79	4000	0.625/0.625/0.250	M233

- Designed and built to conform with MIL-PRF-21038/27 requirements.
- To purchase, select desired operating temperature range and add prefix listed below.

* Choose 1 of 3 Operating Temperature Ranges:

Part Number Prefix	Operating Temperature
C	0°C to +70°C
N	-40°C to +85°C
TQ	-55°C to +125°C

Single Interface Transformers - COTS Low Profile Miniature Series				
Part Number	Turns Ratio ($\pm 3\%$)	Impedance MIN (W)	Package Size L/W/H (in.)	Data Sheet
SMG1553-60	1.25:1	4000	0.400/0.400/0.185	M112
SMG1553-61	1.66:1	4000	0.400/0.400/0.185	M112
SMG1553-65	1:2.50	4000	0.400/0.400/0.185	M112
SMG1553-66	1:1.79	4000	0.400/0.400/0.185	M112
SMG1553-67	1:2.70	4000	0.400/0.400/0.185	M112
SMG1553-68	1:3.75	4000	0.400/0.400/0.185	M112

- Designed and built to conform with MIL-PRF-21038/27 requirements.

Dual Interface Transformers - COTS Low Profile Miniature Series				
Part Number	Turns Ratio ($\pm 3\%$)	Impedance MIN (W)	Package Size L/W/H (in.)	Data Sheet
DKG1553-45	1:2.50/1:1.79	4000	0.675/0.400/0.185	M322
DKG1553-70	1:3/1:2.15	4000	0.675/0.400/0.185	M322
DKG1553-71	1:3.54/1:2.70	4000	0.675/0.400/0.185	M322
DKG1553-72	1:2.65/1:2.07	4000	0.675/0.400/0.185	M322
DKG1553-75	1:2.50/1:1.79	4000	0.675/0.400/0.185	M322

- Designed and built to conform with MIL-PRF-21038/27 requirements.



Mechanicals

DKG1553-XX

Dimensions: inch [mm]
Tolerance (unless otherwise specified): ± 0.010 [0.25]

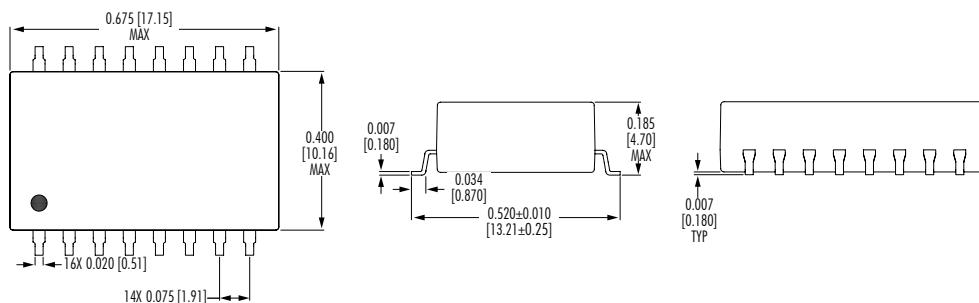

QPL Series - Qualified to MIL-PRF-21038/27					
Part Number	Military Designation Number	Turns Ratio ($\pm 3\%$)	Impedance MIN (W)	Package Size L/W/H (in.)	Data Sheet
Q(X)1553-20	M21038/27-05	1:1.41	3000	0.500/0.350/0.250	M223
Q(X)1553-21	M21038/27-06	1:1	3000	0.500/0.350/0.250	M223
Q(X)1553-22	M21038/27-07	1:1.41	3000	0.500/0.350/0.250	M223
Q(X)1553-23	M21038/27-08	1:1.66	3000	0.500/0.350/0.250	M223
Q(X)1553-24	M21038/27-09	1:2	3000	0.500/0.350/0.250	M223
Q(X)1553-25	M21038/27-28	1:1.50	3000	0.500/0.350/0.250	M223
Q(X)1553-51	M21038/27-29	1:1.79	3000	0.500/0.350/0.250	M223
Q(X)1553-52	M21038/27-30	1:2.50	3000	0.500/0.350/0.250	M223
Q(X)1553-1	M21038/27-01	1:1/1:0.707	4000	0.625/0.625/0.250	M224
Q(X)1553-2	M21038/27-02	1.40:1/2:1	7200	0.625/0.625/0.250	M224
Q(X)1553-3	M21038/27-03	1.25:1/1.66:1	4000	0.625/0.625/0.250	M224
Q(X)1553-5	M21038/27-10	1:2.12/1:1.50	4000	0.625/0.625/0.250	M224
Q(X)1553-45	M21038/27-26	1:2.50/1:1.79	4000	0.625/0.625/0.250	M224
Q(X)1553-81	M21038/27-21	1:1/1:0.707	4000	0.625/0.625/0.275	M224
Q(X)1553-82	M21038/27-22	1.40:1/2:1	7200	0.625/0.625/0.275	M224
Q(X)1553-83	M21038/27-23	1.25:1/1.66:1	4000	0.625/0.625/0.275	M224
Q(X)1553-84	M21038/27-24	1:2.12/1:1.50	4000	0.625/0.625/0.275	M224
Q(X)1553-85	M21038/27-25	1:2.50/1:1.79	4000	0.625/0.625/0.275	M224
FPQ(X)1553-6	M21038/27-16	1:1/1:0.707	4000	0.625/0.625/0.250	M225
SMQ(X)1553-6	M21038/27-11	1:1/1:0.707	4000	0.625/0.625/0.250	M225
FPQ(X)1553-7	M21038/27-17	1.40:1/2:1	7200	0.625/0.625/0.250	M225
SMQ(X)1553-7	M21038/27-12	1.40:1/2:1	7200	0.625/0.625/0.250	M225
FPQ(X)1553-8	M21038/27-18	1.25:1/1.66:1	4000	0.625/0.625/0.250	M225
SMQ(X)1553-8	M21038/27-13	1.25:1/1.66:1	4000	0.625/0.625/0.250	M225
FPQ(X)1553-10	M21038/27-20	1:2.12/1:1.50	4000	0.625/0.625/0.250	M225
SMQ(X)1553-10	M21038/27-15	1:2.12/1:1.50	4000	0.625/0.625/0.250	M225
FPQ(X)1553-45	M21038/27-31	1:2.50/1:1.79	4000	0.625/0.625/0.250	M225
SMQ(X)1553-45	M21038/27-27	1:2.50/1:1.79	4000	0.625/0.625/0.250	M225

- Designed and built to conform with MIL-PRF-21038/27 requirements.
- To purchase, select desired Product Level and choose corresponding Part Number.

* Choose 1 of 3 Product Levels

Part Number Variation	Product Level
Q1553-20	Level M: for general purpose military applications
QC1553-20	Level C: for high reliability commercial/industrial applications
QT1553-20	Level T: for high reliability critical military applications

- Each Product Level utilizes a different degree of Inspection, Sampling and Testing. For specific information, please view the Data Sheets listed in the table above.
- To order in Tape & Reel packaging, add the Suffix "T" to the part number (i.e. Q1553-20T).



GENERAL PURPOSE PULSE TRANSFORMERS							
Part Number	Turns Ratio (1,5):(6,2) ($\pm 2\%$)	Primary Inductance (1-5) MIN (mH)	DCR (1-5, 6-2) MAX (W)	ET MIN (V-us)	Insulation Resistance @250Vdc (KMohm)	Leakage Inductance MAX (μ H)	Data Sheet
IZUHD	1:1	5	1.25	20	10	2.25	M480
IZUHE	1:1	3	1.25	10	10	2.70	M481

LOW-SPEED DATA TRANSFORMERS							
T1/E1/CEPT/ISDN-PRI SMT Transformers							
Part Number	Turns Ratio Pri:Sec ($\pm 2\%$)	OCL Pri MIN (mH)	Cww MAX (pF)	DCR Pri MAX (W)	Primary Pins	Package Size L/W/H (in.)	Data Sheet
X-1707	1:1	1.0	25	0.80	1-3	0.360/0.405/0.270	M487
PL1374	1:1	1.2	35	0.80	1-3	0.300/0.275/0.250	M119
X-1688	1:1	1.2	35	0.80	1-3	0.300/0.275/0.275	M486

LOW-SPEED DATA COMMON MODE CHOKE							
Part Number	1 MHz	Common Mode Attenuation (dB MIN)			Primary Inductance OCL MIN (μ H)	DCR MAX (Ω)	Data Sheet
		10 MHz	100 MHz	500 MHz			
PL1930	-10.0	-15.0	-12.0	-5.0	35	0.15	M218

LOW-SPEED DATA TRANSFORMERS							
64kbps Isolation Transformers							
Part Number	Turns Ratio Pri:Sec ($\pm 2\%$)	Primary Inductance MIN (mH)	Leakage Inductance MAX (μ H)	DCR Pri MAX (W)	Inter-Winding Capacitance	Package Size L/W/H (in.)	Data Sheet
X-1703	2:1	1.0	24	3.00	36	0.940/0.775/0.810	M489
X-1709	1:2	2.0	5.0	2.65	130	0.448/0.335/0.400	M483

HIGH-SPEED DATA TRANSFORMERS							
Fibre Channel Isolation							
Part Number	Turns Ratio Pri:Sec ($\pm 2\%$)	Primary Inductance MIN (μ H)	Cww MAX (pF)	DCR Pri MAX (W)	Hi-Pot MIN (Vrms)	Package Size L/W/H (in.)	Data Sheet
X-1704	1:1	7.5	5	0.20	2000	0.500/0.270/0.200	M482
X-1710	1:1	15	5	0.20	150	0.495/0.280/0.200	M485

CAN BUS (COMMON MODE CHOKES)							
80 VDC - 500 Vrms							
Part Number	Turns Ratio Pri:Sec ($\pm 2\%$)	Inductance (100 kHz) +50% - 30% (μ H)	Leakage Inductance MAX (μ H)	DCR Resistance MAX (W)	Current Rating (mA DC)	Package Size L/W/H (in.)	Data Sheet
X-1711	1:1	11	0.16	0.12	800	0.310/0.260/0.250	M488
X-1712	1:1	25	0.24	0.12	800	0.310/0.260/0.250	M488
X-1713	1:1	51	0.22	0.20	800	0.310/0.260/0.250	M488
X-1714	1:1	100	0.16	0.24	800	0.310/0.260/0.250	M488
X-1715	1:1	471	0.27	0.30	700	0.310/0.260/0.250	M488
X-1716	1:1	1000	0.43	0.40	700	0.310/0.260/0.250	M488

- iNRCORE's standard lead finish is tin/lead (Sn63/Pb37). Parts can be ordered Non-Lead by adding "NL" to the part number (i.e. X-1704NL).
- To order in Tape & Reel packaging, add the suffix "T" to the part number (i.e. X-1709T).



iNRCORE offers custom and catalog power magnetics ruggedized for Military, MIL-PRF-27, MIL-STD-981 and high reliability applications. iNRCORE has a full line of “Off-the-Shelf” inductors for military and aerospace power applications in SLED, SLIC and POGO series packaging. The SLED, SLIC and POGO series use ruggedized high temperature headers suitable for surface mounting to Printed Circuit Board assemblies. Cores are securely bonded to the headers allowing parts to meet MIL-PRF-27 environmental requirements.

iNRCORE offers **Shielded Drum Core Inductors** and **High Frequency Planar Transformers** incorporating ruggedized PCB mounting clips that have superior performance in applications with shock and vibration requirements. iNRCORE also offers catalog **Gate Drive Transformers** with high isolation, miniature **Current Sense Transformers**, and **Common Mode Chokes** with ruggedized construction to meet MIL-PRF-27 Grade 6 requirements.

iNRCORE continues to offer tin/lead termination finishes for Military, Space and Aerospace applications requiring the highest reliability. Parts can also be purchased with tin/lead finishes where RoHS and REACH compliance are required. iNRCORE offers complete design support, qualification test services and global AS9100 manufacturing capabilities.

Toroid Power Inductors - SLED Series							SMT Common Mode Chokes - SLIC Series					
Part Number	@I _{RATED} TYP (μH)	@I _{RATED} (A)	DCR MAX (mW)	L @0Adc TYP (μH)	Package Size L/W/H (in.)	Data Sheet	Part Number	L ±35% (mH)	@I _{RATED} (A)	DCR MAX (mW)	Package Size L/W/H (in.)	Data Sheet
SLED 20							SLIC Series					
PL8100	1.01	3.40	11	1.10	0.400/0.345/0.250	M107	PL8200	0.47	14	8	1.22/1.00/0.500	M108
PL8101	6.20	1.40	70	7.00	0.400/0.345/0.250	M107	PL8201	0.63	11.6	10	1.22/1.00/0.500	M108
PL8102	17.60	1.00	125	22.70	0.400/0.345/0.250	M107	PL8202	0.81	9.70	14	1.22/1.00/0.500	M108
SLED 30							PL8203	0.53	7.20	15	1.11/1.00/0.500	M108
PL8110	3.80	4.80	17.3	5.20	0.625/0.525/0.400	M107	PL8204	0.59	5.60	21	0.770/0.670/0.390	M108
PL8111	9.40	2.80	43.4	12.30	0.625/0.525/0.400	M107	PL8205	0.77	4.70	40	0.770/0.670/0.390	M108
PL8112	29.70	1.40	166	35.30	0.625/0.525/0.400	M107	PL8206	0.22	3.30	60	0.770/0.670/0.390	M108
PL8113	114	0.94	380	167	0.625/0.525/0.400	M107	PL8207	1.32	3.30	60	0.770/0.670/0.390	M108
SLED 40							PL8208	1.47	2.80	80	0.770/0.670/0.390	M108
PL8120	2.50	8.00	8.30	3.80	0.725/0.575/0.410	M107	PL8209	0.88	1.63	110	0.500/0.500/0.215	M108
PL8121	5.10	5.40	17.70	7.50	0.725/0.575/0.410	M107	PL8210	1.17	1.22	200	0.500/0.500/0.215	M108
PL8122	16.2	2.70	72	21.90	0.725/0.575/0.410	M107	PL8211	10.15	1.40	210	0.770/0.670/0.395	M108
PL8123	58.1	1.30	290	73	0.725/0.575/0.410	M107	PL8212	1.125	1.80	55	0.500/0.519/0.200	M108
PL8124	192	0.90	560	292	0.725/0.575/0.410	M107	PL8213	0.80	3.00	27	0.511/0.511/0.338	M108
PL8125	383	0.72	862	672	0.725/0.575/0.410	M107	PL8214	0.383	3.30	18	0.511/0.511/0.220	M108
PL8130	4.90	7.80	12.40	7.90	0.725/0.575/0.410	M107	PL8215	0.536	3.80	17.1	0.645/0.560/0.350	M108
PL8131	9.00	5.50	28	14	0.725/0.575/0.410	M107	PL8216	0.280	4.00	13.2	0.511/0.511/0.220	M108
PL8132	29.1	2.70	100	40.50	0.725/0.575/0.410	M107	PL8217	0.486	4.20	16	0.716/0.590/0.299	M108
PL8133	645	0.74	1250	1134	0.725/0.575/0.410	M107	PL8218	0.130	5.0	6.75	0.519/0.519/0.200	M108
PL8150	0.81	14.30	2.50	1.25	0.725/0.575/0.410	M107	PL8219	0.096	6.0	4.30	0.519/0.519/0.200	M108
PL8151	1.32	11.50	4.00	2.10	0.725/0.575/0.410	M107	PL8220	0.400	6.0	9.40	0.716/0.590/0.393	M108
SLED 50							PL8221	0.061	7.0	2.90	0.531/0.531/0.220	M108
PL8140	9.30	7.20	18.7	16	0.900/0.690/0.520	M107	PL8222	4.84	8.0	7.70	0.770/0.670/0.395	M108
PL8141	16.10	5.10	32	25.9	0.900/0.690/0.520	M107	PL8223	1.22	9.0	9.75	1.22/1.00/0.500	M108
PL8142	50	2.60	133	72.9	0.900/0.690/0.520	M107	PL8224	0.215	10	3.75	0.830/0.751/0.441	M108
PL8143	1070	0.71	1700	1950	0.900/0.690/0.520	M107	PL8225	0.095	12.5	3.0	0.770/0.670/0.395	M108
PL8160	1.68	13.9	3.60	2.80	0.900/0.690/0.520	M107	PL8226	0.117	14	1.90	0.830/0.751/0.441	M108
PL8161	2.50	11.4	5.40	4.20	0.900/0.690/0.520	M107	PL8227	0.500	16	4.25	1.22/1.00/0.500	M108
PL8170	3.50	12.4	6.60	6.50	0.900/0.690/0.520	M107	PL8228	0.380	20	4.10	1.22/1.00/0.500	M108
PL8171	4.70	10.4	8.30	8.40	0.900/0.690/0.520	M107						
SLED 60												
PL8180	5.20	15.4	5.27	10.5	1.275/1.065/0.510	M107						
PL8181	9.40	10.9	10.50	17.6	1.275/1.065/0.510	M107						

- iNRCORE's standard lead finish is tin/lead (Sn63/Pb37). Parts can be ordered Non-Lead by added "NL" to the part number (i.e. PL8222NL).
- To order in Tape & Reel packaging, add the Suffix "T" to the part number (i.e. PL8225T).



POWER INDUCTORS & CHOKES

SMT Power Inductors - SLIC (HCCI-80) Series						
Part Number ¹	@I _{RATED} TYP (μH)	@I _{RATED} (A)	DCR MAX (mW)	L @0Adc TYP (μH)	Package Size L/W/H (in.)	Data Sheet
SLIC (HCCI)						
PL8300 ^P	4.52	19	4.80	9.50	1.22/1.00/0.50	M109
PL8300 ^S	18.1	9.50	19.3	38	1.22/1.00/0.50	M109
PL8301 ^P	3.20	24	3.50	7.20	1.22/1.00/0.50	M109
PL8301 ^S	12.8	12	13.8	7.20	1.22/1.00/0.50	M109
PL8302 ^P	2.45	27	2.50	5.10	1.22/1.00/0.50	M109
PL8302 ^S	9.80	13.5	10.1	20.4	1.22/1.00/0.50	M109
PL8303 ^P	1.60	34	1.60	3.50	1.22/1.00/0.50	M109
PL8303 ^S	6.40	17	6.40	13.8	1.22/1.00/0.50	M109
PL8304 ^P	1.10	38	1.30	2.10	1.22/1.00/0.50	M109
PL8304 ^S	18.1	9.50	19.3	38	1.22/1.00/0.50	M109

SMT Power Inductors - Toroid, SLED Series						
Part Number	@I _{RATED} TYP (μH)	@I _{RATED} (A)	DCR MAX (mW)	L @0Adc TYP (μH)	Package Size L/W/H (in.)	Data Sheet
SLED 25						
PL8500	9.40	3.80	32	10.4	0.625/0.525/0.310	M113
PL8501	13.3	3.20	46	14.6	0.625/0.525/0.310	M113
PL8502	23	2.40	74	25	0.625/0.525/0.310	M113
PL8503	50	1.60	132	56	0.625/0.525/0.310	M113
PL8504	75	1.30	220	83	0.625/0.525/0.310	M113
PL8505	90	1.20	285	100	0.625/0.525/0.310	M113
PL8506	137	1.00	425	152	0.625/0.525/0.310	M113
PL8507	200	0.82	673	220	0.625/0.525/0.310	M113
PL8508	305	0.66	972	331	0.625/0.525/0.310	M113
PL8509	439	0.56	1520	472	0.625/0.525/0.310	M113

SMT Power Inductors - POGO Series						
Part Number ¹	@I _{RATED} TYP (μH)	@I _{RATED} (A)	DCR MAX (mW)	L @0Adc TYP (μH)	Package Size L/W/H (in.)	Data Sheet
POGO 40						
PL8400 ^S	43.6	1.10	309	247.2	0.725/0.575/0.310	M111
POGO 50						
PL8401 ^S	21.9	2.70	90.5	72.4	0.910/0.700/0.400	M111
PL8402 ^S	4.025	6.40	23	18.4	0.910/0.700/0.400	M111
PL8403 ^P	0.53	23.8	3.00	1.00	0.910/0.700/0.400	M111
PL8304 ^P	1.10	21	2.50	1.70	0.910/0.700/0.400	M111
POGO 50						
PL8305 ^P	2.10	22.4	3.40	2.50	1.280/1.070/0.400	M111

SMT Power Inductors - POGO Series (continued)						
Part Number	@I _{RATED} TYP (μH)	@I _{RATED} (A)	DCR MAX (mW)	L @0Adc TYP (μH)	Package Size L/W/H (in.)	Data Sheet
POGO 25						
PL8600 ^P	2.00	8.30	8.0	2.20	0.625/0.525/0.310	M114
PL8600 ^S	7.00	4.16	16	8.75	0.625/0.525/0.310	M114
PL8601 ^P	2.40	7.20	10.9	2.60	0.625/0.525/0.310	M114
PL8601 ^S	8.40	3.78	21.8	10.4	0.625/0.525/0.310	M114
PL8602 ^P	5.00	5.20	19	5.50	0.625/0.525/0.310	M114
PL8602 ^S	17.9	2.60	38	22.45	0.625/0.525/0.310	M114
PL8603 ^P	9.30	3.80	30	10.4	0.625/0.525/0.310	M114
PL8603 ^S	33.8	1.89	60	41.7	0.625/0.525/0.310	M114
PL8604 ^P	14.1	3.10	45.5	15.7	0.625/0.525/0.310	M114
PL8604 ^S	50.9	1.54	91	62.8	0.625/0.525/0.310	M114
PL8605 ^P	19.8	2.60	66.5	22.1	0.625/0.525/0.310	M114
PL8605 ^S	29.3	2.20	101	32.8	0.625/0.525/0.310	M114
PL8606 ^P	29.3	2.20	101	32.8	0.625/0.525/0.310	M114
PL8606 ^S	106.1	1.07	202	131	0.625/0.525/0.310	M114
PL8607 ^P	42.6	1.80	151	47.6	0.625/0.525/0.310	M114

¹ Connection: P = Parallel, S = Series

- iNRCORE's standard lead finish is tin/lead (Sn63/Pb37). Parts can be ordered Non-Lead by adding "NL" to the part number (i.e. PL8400NL).
- To order in Tape & Reel packaging, add the suffix "T" to the part number (i.e. PL8400T).
- The rated current as listed is either the saturation current or the heating current.



POGO 25

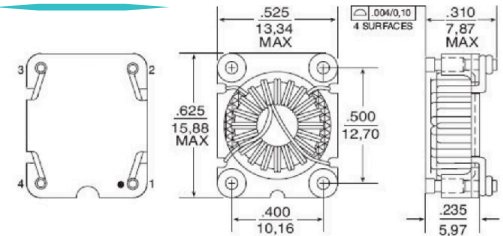

SLED 25

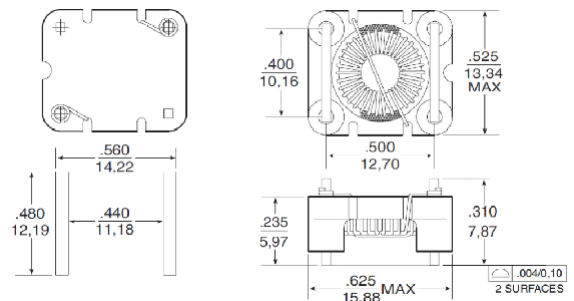

POWER INDUCTORS & CHOKES



SMT Power Inductors - POGO Series (continued)

Part Number ¹	@I _{RATED} TYP (μH)	@I _{RATED} (A)	DCR MAX (mW)	L @0Adc TYP (μH)	Package Size L/W/H (in.)	Data Sheet
POGO 25						
PL8607 ^S	154.2	0.89	302	190.3	0.625/0.525/0.310	M114
PL8608 ^P	61.3	1.50	222	67.5	0.625/0.525/0.310	M114
PL8608 ^S	218.9	0.74	444	270.2	0.625/0.525/0.310	M114
PL8309 ^P	84.2	1.30	318	91	0.625/0.525/0.310	M114
PL8609 ^S	295	0.64	636	364	0.625/0.525/0.310	M114
POGO 40						
PL8700 ^P	1.50	14.4	4.41	2.20	0.725/0.575/0.380	M115
PL8701 ^P	2.40	9.40	6.54	3.50	0.725/0.575/0.380	M115
PL8701 ^S	9.70	5.60	26.2	14	0.725/0.575/0.380	M115
PL8702 ^P	4.20	8.10	10.47	5.90	0.725/0.575/0.380	M115
PL8702 ^S	17	4.10	41.9	23.7	0.725/0.575/0.380	M115
PL8703 ^P	5.80	6.80	14.94	7.90	0.725/0.575/0.380	M115
PL8703 ^S	23.1	3.40	59.7	31.5	0.725/0.575/0.380	M115
PL8704 ^P	7.60	5.70	20.99	10.1	0.725/0.575/0.380	M115
PL8704 ^S	30.6	2.85	84	40.5	0.725/0.575/0.380	M115
PL8705 ^P	12.1	5.20	23.24	18.5	0.725/0.575/0.380	M115
PL8705 ^S	48.5	2.70	93	74.1	0.725/0.575/0.380	M115
PL8706 ^P	18	4.20	38.15	27.4	0.725/0.575/0.380	M115
PL8706 ^S	72	2.20	152.6	109.8	0.725/0.575/0.380	M115
PL8707 ^P	27	3.30	53.21	40.5	0.725/0.575/0.380	M115
PL8707 ^S	108	1.77	212.8	161.8	0.725/0.575/0.380	M115
PL8708 ^P	34.8	2.30	73.89	50.5	0.725/0.575/0.380	M115
PL8708 ^S	139.1	150	295.60	202.2	0.725/0.575/0.380	M115

SMT Common Mode Inductors - Toroid, POGO Series

Part Number ¹	@I _{RATED} TYP (μH)	@I _{RATED} (A)	DCR MAX (mW)	L @0Adc TYP (μH)	Package Size L/W/H (in.)	Data Sheet
POGO 40						
PL8801	1.50	1.50	60	2.00	0.725/0.575/0.380	M116
PL8803	10	1.00	450	0.50	0.725/0.575/0.380	M116
PL8804	22	0.50	850	0.30	0.725/0.575/0.380	M116
POGO 50						
PL8800	1.0	3.60	50	4.00	0.910/0.700/0.510	M116
PL8802	3.0	2.50	80	2.20	0.910/0.700/0.510	M116

¹ Connection: P = Parallel, S = Series

² Inductance at OADC tolerance is ±30%. The tolerance is ±20% on all other parts.

- iNRCORE's standard lead finish is tin/lead (Sn63/Pb37). Parts can be ordered Non-Lead by adding "NL" to the part number (i.e. PL8400NL).
- To order in Tape & Reel packaging, add the suffix "T" to the part number (i.e. PL8400T).

* IMPEDANCE CURVES

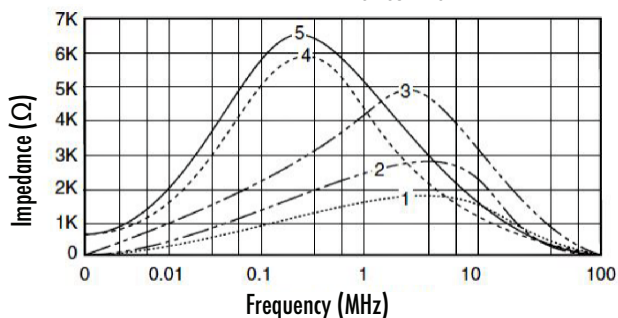

SMT Power Inductors - Shielded Drum Core

Part Number	@I _{RATED} TYP (μH)	@I _{RATED} (A)	DCR MAX (mW)	L @0Adc TYP (μH) ²	Saturation Current @25°C	Package Size L/W/H (in.)	Data Sheet
PL8901	0.80	11	4.0	1.0 ²	14	0.413/0.413/0.280	M117
PL8902	1.20	10	6.0	1.5 ²	13	0.413/0.413/0.280	M117
PL8903	2.10	9.0	7.3	2.7 ²	11	0.413/0.413/0.280	M117
PL8904	2.90	8.0	8.5	3.7 ²	9.2	0.413/0.413/0.280	M117
PL8905	3.70	7.3	9.5	4.7 ²	8.2	0.413/0.413/0.280	M117
PL8906	4.80	6.0	16.5	6.0 ²	6.9	0.413/0.413/0.280	M117
PL8907	6.00	5.5	18.5	7.6 ²	6.2	0.413/0.413/0.280	M117
PL8908	8.00	5.0	21.8	10	5.5	0.413/0.413/0.280	M117
PL8909	9.60	4.5	29	12	5.1	0.413/0.413/0.280	M117
PL8910	12	4.1	35.4	15	4.4	0.413/0.413/0.280	M117
PL8911	14.4	4.0	37	18	4.3	0.413/0.413/0.280	M117
PL8912	17.6	3.8	42	22	3.8	0.413/0.413/0.280	M117
PL8913	21.6	3.4	45.9	27	3.4	0.413/0.413/0.280	M117
PL8914	26.4	3.0	64.8	33	3.0	0.413/0.413/0.280	M117
PL8915	31.2	2.7	81.5	39	2.8	0.413/0.413/0.280	M117
PL8916	37.6	2.6	89	47	2.6	0.413/0.413/0.280	M117
PL8917	54.4	2.1	135	68	2.1	0.413/0.413/0.280	M117
PL9101	0.96	10.5	4.5	1.0 ²	12.7	0.413/0.413/0.248	M121
PL9102	1.52	9.5	5.5	1.8 ²	10.1	0.413/0.413/0.248	M121
PL9103	2.34	7.8	7.8	2.7 ²	8.4	0.413/0.413/0.248	M121
PL9104	3.27	6.7	11	3.9 ²	7.2	0.413/0.413/0.248	M121
PL9105	4.39	5.6	15.6	5.1 ²	6.3	0.413/0.413/0.248	M121
PL9106	5.54	5.2	18	6.8 ²	5.6	0.413/0.413/0.248	M121
PL9107	6.73	5.0	20	8.2 ²	5.1	0.413/0.413/0.248	M121
PL9108	8.19	4.6	22	10	4.6	0.413/0.413/0.248	M121
PL9109	9.90	4.2	27	12	4.2	0.413/0.413/0.248	M121
PL9110	13.4	3.6	30	15	3.6	0.413/0.413/0.248	M121
PL9111	15.4	3.4	40	18	3.4	0.413/0.413/0.248	M121
PL9112	17.6	3.2	45	22	3.2	0.413/0.413/0.248	M121
PL9113	22.5	2.8	62	27	2.8	0.413/0.413/0.248	M121
PL9114	28.5	2.5	70	33	2.5	0.413/0.413/0.248	M121
PL9115	31.4	2.4	75	39	2.4	0.413/0.413/0.248	M121
PL9116	38.4	2.2	100	47	2.2	0.413/0.413/0.248	M121
PL9117	48.3	1.9	110	56	1.9	0.413/0.413/0.248	M121
PL9118	55.9	1.8	120	68	1.8	0.413/0.413/0.248	M121
PL9119	67.6	1.7	178	82	1.7	0.413/0.413/0.248	M121
PL9120	86.1	1.4	230	100	1.4	0.413/0.413/0.248	M121
PL9121	103	1.3	253	120	1.3	0.413/0.413/0.248	M121
PL9122	121	1.2	280	150	1.2	0.413/0.413/0.248	M121
PL9123	149	1.1	310	180	1.1	0.413/0.413/0.248	M121
PL9124	186	1.0	400	220	1.0	0.413/0.413/0.248	M121
PL9125	224	0.91	460	270	0.91	0.413/0.413/0.248	M121
PL9126	279	0.82	690	330	0.82	0.413/0.413/0.248	M121
PL9127	335	0.72	760	390	0.72	0.413/0.413/0.248	M121
PL9128	398	0.68	850	470	0.68	0.413/0.413/0.248	M121
PL9129	464	0.63	1060	560	0.63	0.413/0.413/0.248	M121
PL9130	563	0.57	1200	680	0.57	0.413/0.413/0.248	M121
PL9131	681	0.52	1550	820	0.52	0.413/0.413/0.248	M121



POWER INDUCTORS

SMT Power Inductors - Shielded Drum Core (continued)

Part Number	@I _{RATED} TYP (μ H)	I _{RATED} (A)	DCR MAX (mW)	L @0Adc TYP (μ H)	Saturation Current @25°C	Package Size L/W/H (in.)	Data Sheet	Part Number	@I _{RATED} TYP (μ H)	I _{RATED} (A)	DCR MAX (mW)	L @0Adc TYP (μ H)	Saturation Current @25°C	Package Size L/W/H (in.)	Data Sheet
PL9201	0.95	8.70	5.70	1.0	11	0.413/0.413/0.201	M122	PL9401	0.67	7.00	4.40	0.68	7.0	0.410/0.410/0.132	M123
PL9202	1.55	7.40	7.90	1.6	8.8	0.413/0.413/0.201	M122	PL9402	1.30	6.10	6.40	1.50	6.10	0.410/0.410/0.132	M123
PL9203	2.32	6.60	10	2.7	7.3	0.413/0.413/0.201	M122	PL9403	2.10	5.70	10.4	2.20	5.70	0.410/0.410/0.132	M123
PL9204	3.24	5.50	4.50	3.6	6.3	0.413/0.413/0.201	M122	PL9404	3.10	4.80	15.6	3.30	4.80	0.410/0.410/0.132	M123
PL9205	4.26	5.10	16.5	4.5	5.5	0.413/0.413/0.201	M122	PL9405	4.50	4.10	21.2	4.70	4.10	0.410/0.410/0.132	M123
PL9206	5.64	4.40	22	6.0	4.9	0.413/0.413/0.201	M122	PL9406	5.80	3.60	25.2	6.20	3.60	0.410/0.410/0.132	M123
PL9207	7.17	4.20	25	7.6	4.4	0.413/0.413/0.201	M122	PL9407	7.00	3.30	27.8	6.80	3.30	0.410/0.410/0.132	M123
PL9208	9.30	3.60	35	10	4.0	0.413/0.413/0.201	M122	PL9408	9.40	3.00	39.5	8.20	3.00	0.410/0.410/0.132	M123
PL9209	10.8	3.30	37	12	3.7	0.413/0.413/0.201	M122	PL9409	11	2.70	42.9	10	2.70	0.410/0.410/0.132	M123
PL9210	13.4	3.00	47	15	3.4	0.413/0.413/0.201	M122	PL9410	12	2.40	50.0	12	2.40	0.410/0.410/0.132	M123
PL9211	17.5	2.70	58	18	2.9	0.413/0.413/0.201	M122	PL9411	15	2.25	65.2	15	2.25	0.410/0.410/0.132	M123
PL9212	19.4	2.60	67	22	2.8	0.413/0.413/0.201	M122	PL9412	24	1.85	86.1	22	1.85	0.410/0.410/0.132	M123
PL9213	24.2	2.20	79	27	2.4	0.413/0.413/0.201	M122	PL9413	35	1.40	126	33	1.40	0.410/0.410/0.132	M123
PL9214	30.6	2.10	94	33	2.2	0.413/0.413/0.201	M122	PL9414	48	1.25	188	47	1.25	0.410/0.410/0.132	M123
PL9215	38.5	1.80	126	39	2.0	0.413/0.413/0.201	M122	PL9415	55	1.15	208	56	1.15	0.410/0.410/0.132	M123
PL9216	46.1	1.70	140	47	1.8	0.413/0.413/0.201	M122	PL9416	64	1.05	279	68	1.05	0.410/0.410/0.132	M123
PL9217	53.2	1.60	157	56	1.7	0.413/0.413/0.201	M122	PL9417	88	0.94	317	82	0.94	0.410/0.410/0.132	M123
PL9218	63.1	1.45	202	68	1.6	0.413/0.413/0.201	M122	PL9418	106	0.88	358	100	0.88	0.410/0.410/0.132	M123
PL9219	76.6	1.36	232	82	1.4	0.413/0.413/0.201	M122	PL9419	129	0.80	478	120	0.80	0.410/0.410/0.132	M123
PL9220	88	1.29	270	100	1.3	0.413/0.413/0.201	M122	PL9420	157	0.70	545	150	0.70	0.410/0.410/0.132	M123
PL9221	112	1.07	316	120	1.2	0.413/0.413/0.201	M122	PL9421	238	0.58	837	220	0.58	0.410/0.410/0.132	M123
PL9222	135	1.02	456	150	1.05	0.413/0.413/0.201	M122	PL9422	325	0.45	1199	330	0.45	0.410/0.410/0.132	M123
PL9223	132	0.87	497	180	0.96	0.413/0.413/0.201	M122	PL9501	2.15	2.60	17.6	2.50	2.60	0.256/0.256/0.122	M124
PL9224	198	0.82	681	220	0.86	0.413/0.413/0.201	M122	PL9502	2.58	2.30	20.3	3.30	2.30	0.256/0.256/0.122	M124
PL9225	237	0.78	775	270	0.79	0.413/0.413/0.201	M122	PL9503	3.43	2.10	27	4	2.10	0.256/0.256/0.122	M124
PL9226	296	0.66	955	330	0.71	0.413/0.413/0.201	M122	PL9504	4.63	1.85	31.1	5	1.85	0.256/0.256/0.122	M124
PL9227	355	0.58	1087	390	0.66	0.413/0.413/0.201	M122	PL9505	5.22	1.70	41.9	6	1.70	0.256/0.256/0.122	M124
PL9228	445	0.54	1403	470	0.59	0.413/0.413/0.201	M122	PL9506	6.57	1.50	49.9	8	1.50	0.256/0.256/0.122	M124
PL9229	495	0.53	1623	560	0.54	0.413/0.413/0.201	M122	PL9507	8.65	1.30	54	10	1.30	0.256/0.256/0.122	M124
PL9230	610	0.49	1824	680	0.49	0.413/0.413/0.201	M122	PL9508	9.78	1.20	72	12	1.20	0.256/0.256/0.122	M124
PL9231	702	0.43	2355	820	0.45	0.413/0.413/0.201	M122	PL9509	12.13	1.10	82	15	1.10	0.256/0.256/0.122	M124
PL9232	890	0.40	2850	1000	0.41	0.413/0.413/0.201	M122	PL9510	15.23	1.05	102	18	1.05	0.256/0.256/0.122	M124
PL9301	0.62	7.60	5.50	0.68	10	0.410/0.410/0.157	M120	PL9511	18.70	0.95	119	22	0.95	0.256/0.256/0.122	M124
PL9302	1.20	7.10	7.30	1.30	8	0.410/0.410/0.157	M120	PL9512	21.54	0.85	146	27	0.85	0.256/0.256/0.122	M124
PL9303	1.90	5.80	10.9	2.2	6.15	0.410/0.410/0.157	M120	PL9513	27.71	0.76	183	33	0.76	0.256/0.256/0.122	M124
PL9304	2.80	5.20	13.3	3.3	5.80	0.410/0.410/0.157	M120	PL9514	33.57	0.68	210	39	0.68	0.256/0.256/0.122	M124
PL9305	4.00	4.70	19.6	4.7	5.40	0.410/0.410/0.157	M120	PL9515	40.15	0.60	230	47	0.60	0.256/0.256/0.122	M124
PL9306	5.40	3.70	27	6.0	4.50	0.410/0.410/0.157	M120	PL9516	49.68	0.55	305	56	0.55	0.256/0.256/0.122	M124
PL9307	6.90	3.50	30.8	7.6	4	0.410/0.410/0.157	M120	PL9517	60.66	0.48	351	68	0.48	0.256/0.256/0.122	M124
PL9308	8.00	3.40	33.2	10	3.80	0.410/0.410/0.157	M120	PL9518	74.71	0.45	419	82	0.45	0.256/0.256/0.122	M124
PL9309	11	3.00	45.2	12	3.40	0.410/0.410/0.157	M120	PL9519	85.39	0.40	520	100	0.40	0.256/0.256/0.122	M124
PL9310	12	2.80	49.4	15	3.10	0.410/0.410/0.157	M120								
PL9311	19	2.30	77	22	2.80	0.410/0.410/0.157	M120								
PL9312	25	2.10	89	27	2.30	0.410/0.410/0.157	M120								
PL9313	38	1.65	142	47	2.10	0.410/0.410/0.157	M120								
PL9314	55	1.32	212	68	1.50	0.410/0.410/0.157	M120								
PL9315	83	1.10	328	100	1.35	0.410/0.410/0.157	M120								
PL9316	123	0.88	500	150	1.15	0.410/0.410/0.157	M120								
PL9317	178	0.73	739	220	0.92	0.410/0.410/0.157	M120								
PL9318	278	0.60	1133	330	0.70	0.410/0.410/0.157	M120								

¹ The rated current as listed is either the saturation current or the heating current depending on which value is lower.

- iNRCORE's standard lead finish is tin/lead (Sn63/Pb37). Parts can be ordered Non-Lead by adding "NL" to the part number (i.e. PL9515NL).
- To order in Tape & Reel packaging, add the suffix "T" to the part number (i.e. PL9515T).

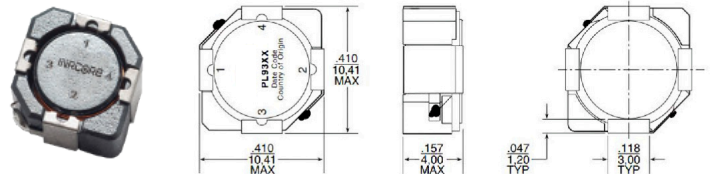



PLANAR POWER INDUCTORS

Electrical Specifications @25°C; Operating Temperature: -40°C to +130°C

Part Number ¹	L @I _{RATED} (μH±15%)	I _{RATED} ¹ (ADC)	DCR TYP (mW)	DCR MAX (mW)	L @0Adc (μH±15%)	Saturation Current (ADC)		Heating Current (A)	Data Sheet
						25°C	100°C		
2-Turn Series (Low Loss)									
PL10100	0.45	73	0.38	0.48	0.45	95	80	73	M194
PL10101	0.63	54	0.38	0.48	0.65	63	53	73	M194
PL10102	0.85	39	0.38	0.48	0.91	46	37	73	M194
PL10103	1.05	30	0.38	0.48	1.10	35	30	73	M194
PL10104	1.25	25	0.38	0.48	1.30	29	26	73	M194
PL10105	1.45	21	0.38	0.48	1.50	24	22	73	M194
2-Turn Series									
PL10106	0.45	52	0.78	0.98	0.45	95	80	52	M194
PL10107	0.63	52	0.78	0.98	0.65	63	53	52	M194
PL10108	0.85	39	0.78	0.98	0.91	46	37	52	M194
PL10109	1.05	30	0.78	0.98	1.10	35	30	52	M194
PL10110	1.25	25	0.78	0.98	1.30	29	26	52	M194
PL10111	1.45	21	0.78	0.98	1.50	24	22	52	M194
3-Turn Series									
PL10112	0.95	42	1.15	1.43	1.00	68	54	42	M194
PL10113	1.40	36	1.15	1.43	1.50	43	35	42	M194
PL10114	1.90	25	1.15	1.43	2.00	29	25	42	M194
PL10115	2.40	20	1.15	1.43	2.50	23	21	42	M194
PL10116	2.80	15	1.15	1.43	3.00	18	16	42	M194
PL10117	3.40	12	1.15	1.43	3.50	15	13	42	M194
4-Turn Series									
PL10118	1.60	37	1.44	1.80	1.60	55	43	37	M194
PL10119	2.40	30	1.44	1.80	2.42	35	27	37	M194
PL10120	3.30	17	1.44	1.80	3.60	20	18	37	M194
PL10121	4.00	14	1.44	1.80	4.40	16	15	37	M194
PL10122	4.90	11	1.44	1.80	5.34	13	12	37	M194
PL10123	5.80	9	1.44	1.80	6.20	11	10	37	M194

- INRCORE's standard lead finish is tin/lead (Sn63/Pb37). Parts can be ordered Non-Lead by adding "NL" to the part number (i.e. PL10111NL).
- To order in Tape & Reel packaging, add the suffix "T" to the part number (i.e. PL10210T).





HIGH FREQUENCY PLANAR TRANSFORMERS

Electrical Specifications @25°C - Power Rating up to 250W

Part Number	Turns Ratio		Primary Inductance MIN (μH)	Leakage Inductance MIN (μH)	DCR mΩ MAX			Data Sheet
	Primary	Secondary			Primary A	Primary B	Secondary	
PL10201	4T & 4T	1T:1T:1T:1T	216	0.30	13	13	4.5	M343
PL10203	5T & 5T	1T:1T:1T:1T	340	0.30	15	15	4.5	M343
PL10205	6T & 6T	1T:1T:1T:1T	480	0.30	21	21	4.5	M343
PL10207	7T & 7T	1T:1T:1T:1T	660	0.30	50	50	4.5	M343
PL10208	4T & 4T	1T & 1T	216	0.30	13	13	4.5	M343
PL10209	8T & 8T	1T:1T:1T:1T	860	0.30	60	60	4.5	M343
PL10210	5T & 5T (w/ 5T aux)	1T & 1T	340	0.30	15	15	0.56 & 0.56	M343
PL10212	6T & 6T (w/ 2T aux)	1T & 1T	480	0.30	21	21	0.56 & 0.56	M343
PL10214	7T & 7T (w/ 3T aux)	1T & 1T	660	0.30	50	50	0.56 & 0.56	M343
PL10216	8T & 8T	1T & 1T	860	0.30	60	60	0.56 & 0.56	M343
PL10230	4T	1T:1T:1T:1T	54	0.30	13	-	4.5	M343
PL10231	5T (w/ 5T aux)	1T:1T:1T:1T	85	0.30	15	470	4.5	M343
PL10232	6T (w/ 2T aux)	1T:1T:1T:1T	120	0.30	21	156	4.5	M343
PL10233	7T (w/ 3T aux)	1T:1T:1T:1T	165	0.30	50	200	4.5	M343
PL10234	4T	7T & 7T	54	0.30	13	-	4.5	M343
PL10235	5T (w/ 5T aux)	7T & 7T	85	0.30	15	470	40 & 40	M343
PL10236	6T (w/ 2T aux)	7T & 7T	120	0.30	21	156	40 & 40	M343
PL10237	7T (w/ 3T aux)	7T & 7T	165	0.30	50	200	40 & 40	M343
PL10238	4T	1T & 1T	54	0.30	13	-	40 & 40	M343
PL10239	5T (w/ 5T aux)	1T & 1T	85	0.30	15	470	40 & 40	M343
PL10240	6T (w/ 2T aux)	1T & 1T	120	0.30	21	156	1.12 & 1.12	M343
PL10241	7T (w/ 3T aux)	1T & 1T	165	0.30	50	200	1.12 & 1.12	M343
PL10242	4T	2T & 1T	54	0.30	13	-	1.12 & 1.12	M343
PL10243	5T (w/ 5T aux)	2T & 1T	85	0.30	15	470	1.12 & 1.12	M343
PL10244	6T (w/ 2T aux)	2T & 1T	120	0.30	21	156	1.12 & 1.12	M343
PL10245	7T (w/ 3T aux)	2T & 1T	165	0.30	50	200	1.80 & 0.60	M343
PL10246	8T	1T:1T:1T:1T	215	0.30	60	-	1.80 & 0.60	M343
PL10247	8T	2T & 1T	215	0.30	60	-	1.80 & 0.60	M343
PL10248	8T	1T & 1T	215	0.30	60	-	1.80 & 0.60	M343
PL10249	8T	2T & 1T	215	0.30	60	-	1.80 & 0.60	M343

- iNRCORE's standard lead finish is tin/lead (Sn63/Pb37). Parts can be ordered Non-Lead by adding "NL" to the part number (i.e. PL10122NL).
- To order in Tape & Reel packaging, add the suffix "T" to the part number (i.e. PL10210T).

Design Specifications

Design Type	Maximum Height	Part Numbers
Double Interleave Design*	10.2mm	PL10201-16
Single Interleave Design	9.10mm	PL10230-49

* Higher efficiency, lower DCR and lower leakage.

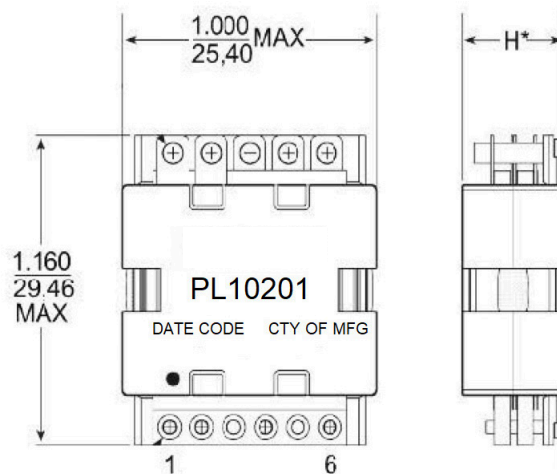

*H - Maximum Height (see table above)





HIGH FREQUENCY PLANAR TRANSFORMERS

Electrical Specifications @25°C - Power Rating up to 140W

Part Number	Turns Ratio		Primary Inductance MIN (μH)	Leakage Inductance MIN (μH)	DCR mΩ MAX			Data Sheet
	Primary	Secondary			Primary A	Primary B	Secondary	
PL10301	4T	5T	153	0.45	17.5	17.5	7	M314
PL10302	4T	5T	194	0.45	17.5	20	7	M314
PL10303	5T	5T	240	0.55	20	20	7	M314
PL10304	5T	6T	290	0.60	20	25	7	M314
PL10305	6T	6T	345	0.65	25	25	7	M314
PL10306	4T	4T	153	0.40	7.5	17.5	0.875 & 0.875	M314
PL10307	4T	5T	194	0.40	17.5	20	0.875 & 0.875	M314
PL10308	5T	5T	240	0.50	20	20	0.875 & 0.875	M314
PL10309	5T	6T	290	0.60	20	25	0.875 & 0.875	M314
PL10310	6T	6T	345	0.60	25	25	1.75 & 1.75	M314
PL10311	4T	4T	153	0.40	17.5	17.5	1.75 & 1.75	M314
PL10312	4T	5T	194	0.40	17.5	20	1.75 & 1.75	M314
PL10313	5T	5T	240	0.40	20	20	1.75 & 1.75	M314
PL10314	5T	5T	290	0.50	20	25	1.75 & 1.75	M314
PL10315	6T	6T	345	0.50	25	25	1.75 & 1.75	M314



HIGH FREQUENCY PLANAR TRANSFORMERS

Electrical Specifications @25°C - Power Rating up to 300W

Part Number	Turns Ratio		Primary Inductance MIN (μH)	Leakage Inductance MIN (μH)	DCR mΩ MAX			Data Sheet
	Primary	Secondary			Primary A	Primary B	Secondary	
PL10401	4T & 4T	1T:1T:1T:1T	211	0.30	6.8	6.8	4.5	M380
PL10402	5T & 5T	1T:1T:1T:1T	330	0.40	8.5	8.5	4.5	M380
PL10403	6T & 6T	1T:1T:1T:1T	423	0.60	10.2	10.2	4.5	M380
PL10404	7T & 7T	1T:1T:1T:1T	588	0.80	11.8	11.8	4.5	M380
PL10405	4T & 4T	1T:1T:1T:1T	768	1.20	13.4	13.4	4.5	M380
PL10406	8T & 8T	1T & 1T	216	0.45	6.8	6.8	0.056 & 0.056	M380
PL10407	5T & 5T	1T & 1T	340	0.84	8.5	8.5	0.056 & 0.056	M380
PL10408	6T & 6T	1T & 1T	480	1.00	10.2	10.2	0.056 & 0.056	M380
PL10409	7T & 7T	1T & 1T	660	1.20	11.8	11.8	0.056 & 0.056	M380
PL10410	8T & 8T	1T & 1T	860	1.70	13.4	13.4	0.056 & 0.056	M380

- iNRCORE's standard lead finish is tin/lead (Sn63/Pb37). Parts can be ordered Non-Lead by adding "NL" to the part number (i.e. PL10305NL).
- To order in Tape & Reel packaging, add the suffix "T" to the part number (i.e. PL10305T).

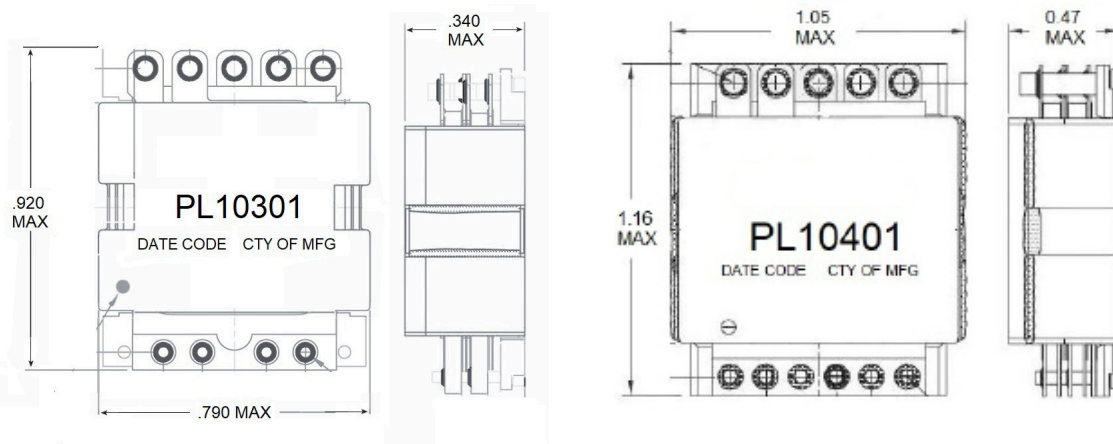

INRCORE POWER PRODUCTS

SMT CURRENT SENSE TRANSFORMERS							
Electrical Specifications @25°C; Operating Temperature: -55°C to +130°C; Current Rating: 10A							
Part Number	Turns Ratio	Current Rating (A)	Secondary Inductance MIN (μH)	DCR mΩ MAX		HiPot (Vrms)	Data Sheet
				(8-7)	(1-3)		
PL3250	1:20	10	0.080	6	550	1000	M278
PL3251	1:30	10	0.180	6	870	1000	M278
PL3252	1:40	10	0.320	6	1140	1000	M278
PL3253	1:50	10	0.500	6	1500	1000	M278
PL3254	1:60	10	0.720	6	2250	1000	M278
PL3255	1:70	10	0.980	6	4750	1000	M278
PL3256	1:100	10	2.00	6	5500	1000	M278
PL3257	1:125	10	3.00	6	6500	700	M278

SMT CURRENT SENSE TRANSFORMERS							
Electrical Specifications @25°C; Operating Temperature: -55°C to +130°C; Current Rating: 10A							
Part Number	Turns Ratio	Current Rating (A)	Secondary Inductance MIN (μH)	DCR mΩ MAX		HiPot (Vrms)	Data Sheet
				(8-7)	(1-3)		
PL3258	1:20	20	0.080	0.75	550	1000	M279
PL3259	1:30	20	0.18	0.75	870	1000	M279
PL3260	1:40	20	0.32	0.75	1140	1000	M279
PL3261	1:50	20	0.50	0.75	1500	1000	M279
PL3262	1:60	20	0.72	0.75	2250	1000	M279
PL3263	1:70	20	0.98	0.75	4750	1000	M279
PL3264	1:100	20	2.00	0.75	5500	1000	M279
PL3265	1:125	20	3.00	0.75	6500	700	M279
PL3479	1:200	20	8.00	0.75	17000	700	M279

SMT CURRENT SENSE TRANSFORMERS							
Electrical Specifications @25°C; Operating Temperature: -55°C to +130°C; Current Rating: 15A							
Part Number	Turns Ratio	Current Rating (A)	Secondary Inductance MIN (μH)	DCR mΩ MAX		HiPot (Vrms)	Data Sheet
				(1,3-2,4)	(5-6)		
PL1170	1:1:100	15	14.8	1.5	930	500	M133
PL1961	1:1:200	15	59.2	2.3	4200	500	M150

SMT CURRENT SENSE TRANSFORMERS							
Electrical Specifications @25°C; Operating Temperature: -55°C to +130°C; Current Rating: 35A							
Part Number	Turns Ratio	Current Rating (A)	Secondary Inductance MIN (μH)	DCR mΩ MAX		HiPot (Vrms)	Data Sheet
				(11-12)	(2-4)		
PL1839	50:1	35	1.40	0.42	700	1800	M302
PL1808	100:1	35	5.60	0.42	1400	1800	M302
PL1840	200:1	35	22.40	0.42	2900	1800	M302



Performance warranty of products offered on this data sheet is limited to the parameters specified. Data is subject to change without notice. Other brand and product names mentioned herein may be trademarks or registered trademarks of their respective owners. © Copyright, 2020. INRCORE, LLC. All rights reserved.

12/2021

www.INRCORE.com

AUDIO TRANSFORMERS							
Electrical Specifications @25°C; Operating Temperature: -40°C to +130°C							
Part Number	Turns Ratio Pri:Sec ±2%	Primary Impedance (Ω ±10%)	Insertion Loss MAX 1KHz/1.0Vrms (dB)	DCR Ω MAX		HiPot (Vrms)	Data Sheet
				(2-4)	(7-9)		
PL3141	1.10	600	1.55	55	67	1500	M358
PL3183	1.10	150	1.50	12	14	1250	M508

GATE DRIVE TRANSFORMERS										
1000VDC to 1500VDC - Basic & Functional Insulation										
Part Number	Turns Ratio	Pri-Sec Insulation	MAX (v*usec)	Primary Inductance MAX (μH)	Leakage Inductance MAX (μH)	DCR Ω MAX		Package Size L/W/H (in.)	Insulation	Data Sheet
						Primary	Secondary			
PL3172NL	1:1	1500 Vrms	9.7	1200	0.50	0.91	0.91	0.355/0.340/0.300	Functional	M297
PL1960	1:1	1500 VDC	9.7	785	0.46	0.60	0.60	0.265/0.340/0.140	Functional	M149
PL3280	1:1:1	1500 Vrms	12.7	800	0.65	0.75	0.75	0.340/0.265/0.140	Functional	M296
X-1569NL	1:1:1	1500 VDC	45.1	3330	0.70	1.60	1.60	0.355/0.340/0.300	Functional	M258
X-1622NL	1:1:1	1500 Vrms	60	1400	1.50	1.60	1.50/1.50	0.355/0.340/0.300	Functional	M295
PL3057NL	2.5:1:1	1500 Vrms	27.2	1200	0.80	0.91	0.38/0.38	0.355/0.340/0.300	Basic	M294
PL2973	1:1	1500 VDC	27.2	1200	0.50	0.91	0.91	0.355/0.340/0.300	Basic	M299
PL3140	2:1:1	1500 Vrms	-	1200	0.60	0.91	0.46	0.355/0.340/0.300	Functional	M383
PL3002	1:1:1	1600 Vrms	866	5000	0.50	6	7.2/7.2	0.750/0.750/0.500	Functional	M386
PL2148NL	1:1	1500 Vrms	55	1486	0.80	1.15	1.15	0.355/0.340/0.300	Functional	M387
PL3159	1:1:1	2700 VDC	21	507	0.40	0.85	0.85/0.85	0.315/0.200/0.118	Functional	M388
PL3212NL	1:1:1	3000 Vrms	95	450	0.50	0.080	0.072	0.810/0.750/0.480	Basic	M389
PL3215NL	1:1:1	6000 Vrms	115	686	0.80	0.71	0.71/0.71	0.750/0.810/0.480	Basic	M394
PL3445NL	1:1:1	1500 Vrms	85	7200	2.0	3.0	3.3	0.355/0.340/0.300	Functional	M395
PL3602NL	2:1:1	4000 Vrms	375	1500	8.0	2.2	1.60/1.60	0.650/0.500/0.599	Functional	M396
PL3716	1:1	700 Vrms	126	2500	4.0	5.8	6.20	0.650/0.443/0.400	Functional	M392
PL3839NL	1:1:1	2500 Vrms	48	1500	TBD	1.5	1.50/1.50	0.572/0.512/0.340	Functional	M393
PL3840	1:1	10 KVrms	320	1850	15	0.133	0.12/0.085	1.319/1.417/0.728	Functional	M397
PL1863	2:1:1	2500 VDC	27.2	1200	0.60	0.91	0.46/0.46	0.355/0.340/0.300	Functional	M398
PL1903	1:1	1500 Vrms	15.4	750	0.75	0.88	0.70	0.470/0.350/0.160	Basic	M410
PL2064	1:2.5:2.5	3750 Vrms	10.88	162	0.24	0.28	0.56/0.56	0.665/0.421/0.267	Basic	M412
PL2072	1:1	1500 Vrms	12	403.2	0.46	0.685	0.685	0.345/0.265/0.098	Functional	M367
10B-1002	1:1	700 Vrms	24	10000	30	11	11	0.650/0.443/0.440	Functional	M464

¹ The maximum volt*μSec rating limits the peak flux density to 2200 Gauss when used in a unipolar drive application. For bi-polar drive applications a maximum volt*μsec of two times this rating is acceptable (i.e. 2* (volt*μsec rating) Volt*μsec = (voltage applied to the primary) * duty cycle / Frequency = V * alpha / Freq_Hz = V * μsec

² Leakage inductance is measured at primary terminals with all secondaries shorted.

- INRCORE's standard lead finish is tin/lead (Sn63/Pb37). Parts can be ordered Non-Lead by adding "NL" to the part number (i.e. PL2973NL).
- To order in Tape & Reel packaging, add the suffix "T" to the part number (i.e. PL3280T).



DISCONTINUOUS HIGH VOLTAGE FLYBACK TRANSFORMERS							
Electrical Specifications @25°C; Operating Temperature: -55°C to +125°C							
Part Number	Turns Ratio	Voltage Output (V _{out})	Primary Inductance (μH)	Primary Inductance Leakage MAX (nH)	DCR Ω MAX		Data Sheet
					(1-4)	(5-8)	
PL4761	1:20	1400	8.5 - 9.5	650	0.50	80	M569
PL4762	1:30	1800	8.5 - 9.5	750	0.50	115	M569
PL4763	1:40	2000	8.5 - 9.5	850	0.50	150	M569

iNRCORE CUSTOM CAPABILITIES

SPACE DEVELOPMENT / TESTING / VALIDATION CAPABILITIES

- MIL-STD-981
- NASA EEE-INST-002
- NASA-STD 8739.3
- IPC-STD-001DS
- ESA
- IPC-610
- MIL-PRF-21038
- MIL-PRF-27
- MIL-STD-202
- ECSS-Q-ST-70-38C
- UL 60601
- CSA C22.2
- AEC-Q200
- MIL-STD-883
- Custom Magnetic Power
- Signal Design/Build
- MIL-STD-810
- IPC/WHMA-A-620

MANUFACTURING CAPABILITIES

- Bobbin Winding
- SMT Board Assembly
- In-House Machine Shop
- Custom Lead Forming
- Toroid Winding
- Electrical/Mechanical Assembly
- Automated Electrical Test
- E.S.S. Capability
- Automated Solder Tinning
- AS9100 Certified Facilities
- Harness Assembly
- Transfer Molding
- Vacuum Encapsulation

SPACE PROGRAM PARTICIPATION

- ISS
- Orion
- Artemis
- Europa Clipper
- James Webb
- JUICE
- OSIRIS-REx
- Cygnus
- Nancy Grace Roman

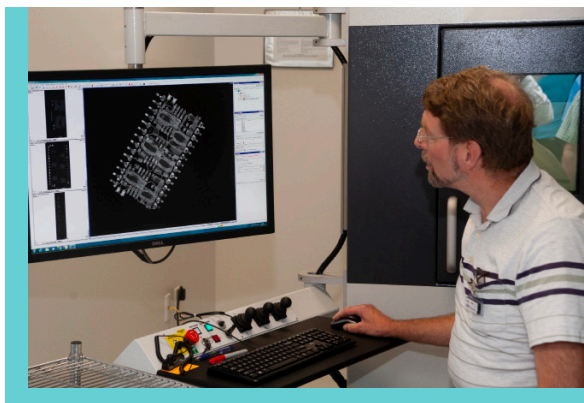
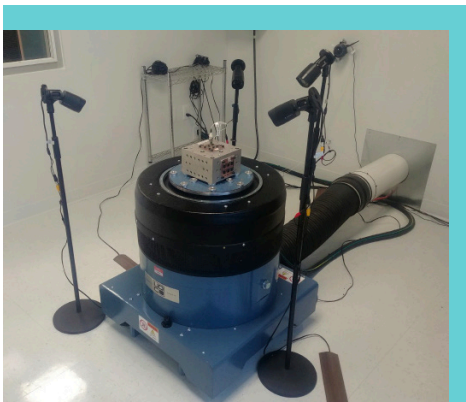
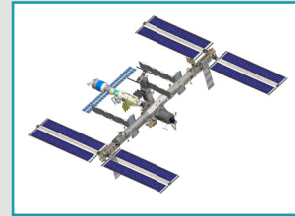
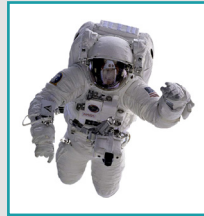
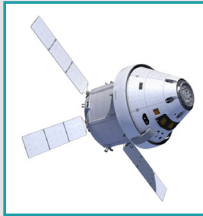

iNRCORE CUSTOM CAPABILITIES

Product Capability	Packaging	Max Power	Max Current	Frequency
Single Inductors	Lamination, Toroidal, Tape Wound	-	4 KVA	15 - 2 MHz
Common Mode Chokes 1/3 Phase	Lamination, Toroidal, Tape Wound	-	500 A	15 - 2400 Hz
Chokes - 3 Phase (Line Filtering)	Lamination, Tape Wound	-	500 A	15 - 2400 Hz
Power Transformers - 1 Phase	Lamination, Toroidal, Tape Wound	10 KVA	-	15 - 1200 Hz
Transformers - Laminated 3 Phase	Lamination, Toroidal, Tape Wound	10 KVA	-	15 - 1200 Hz
Transformers - Switch Mode	Planar, Bobbin Wound, Toroidal	10 KVA	-	20K - 1 MHz
Inductors - Switchmode Buck/Boost	Toroidal, Bobbin Wound	500 VA	-	20K - 1 MHz
Transformers - Current Sense	Toroidal, Bobbin Wound	4 KVA (burden)	-	15 - 1 MHz
Transformer Modules - Current Sense 1/3 Phase	Toroidal, Bobbin Wound	4 KVA (burden)	-	15 - 1 MHz
Transformers - Gate Drive	Toroidal, Bobbin Wound	-	-	20 KHz - 1 MHz
Current Sense Transformers	Lamination, Toroidal, Tape Wound	-	10 KVA	15 - 1200 Hz

TESTING SERVICES

Testing capabilities for product qualification and design validation

ELECTRICAL

- Inductance with or without DC
- Turns Ratio
- HI-POT - Vac up to 5kV, Vdc up to 6kV
- Insulation Resistance
- Distortion
- Pulse Testing
- Thermal Rise
- Impedance
- Q (up to 1MHz)
- DCR
- SRF (up to 3GHz)
- Leakage Inductance
- Voltage Ratio
- Insertion Loss

ENVIRONMENTAL

- Mechanical Shock
- Mechanical Vibration
- Solderability
- Resistance to Soldering
- Tin Whisker Analysis

MECHANICAL

- Humidity (to 90% RH)
- Moisture Resistance
- Thermal Shock
- Thermal Cycling
- High/Low Temperature Storage
- Steam Aging

ANALYTICAL

- X-Ray Imaging
- Real Time X-Ray
- Plating Composition Analysis
- Detailed Inspection Plans
- First Article Inspection to AS9102

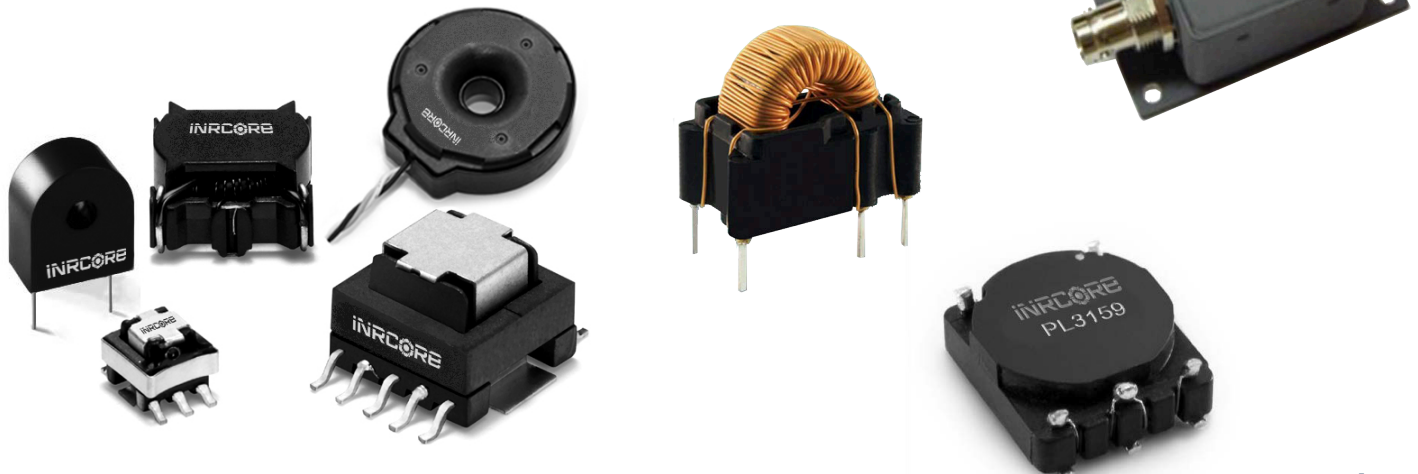

INDUCTOR DESIGN WORKSHEET

CONTACT INFORMATION

Company/Division _____

Contact Name _____

Telephone _____

Street Address _____

City _____

State _____

Zip Code _____

Email Address _____

ELECTRICAL

Common Mode Differential Mode PFC Resonant

For PFC inductor ONLY, please specify RMS current at 100-120Hz: _____

And peak-to-peak current for operation frequency: _____

Winding 1

Winding 2

Winding 3

Inductance Range: _____

Rated Current: _____

Ripple Current: _____

QF (Quality Factor): _____

SRF (Self-Resonant Frequency) Minimum: _____

MECHANICAL

Mounting Type: Surface Mount Through-Hole Other: _____

Maximum Size: Length: _____ Width: _____ Height: _____

SAFETY & ENVIRONMENTAL REQUIREMENTS

Dielectric Withstanding Voltage (DWV): _____ DC RMS

Ambient Temperature Range: _____ °C Temperature Rise, MAX: _____ °C

Lead/Terminal Finish: Tin/Lead Pure Tin Other: _____

OTHER

Production Start Date _____

EAU or QTY to be Quoted _____

Target Price (USD) _____

Part Number _____

Competitor Part Number _____

Application _____

Program Name _____

Restricted/ITAR: Yes No



TRANSFORMER DESIGN WORKSHEET

CONTACT INFORMATION

Company/Division _____

Contact Name _____

Telephone _____

Street Address _____

City _____

State _____

Zip Code _____

Email Address _____

ELECTRICAL

Total Output Power of Power Supply: _____

Switching Frequency: _____ (kHz) Maximum Duty Cycle: _____

Topology:

Flyback Continuous Flyback Discontinuous Forward Converter Active Clamp Forward Two-Switch Forward Push-Pull Half Bridge Full-Bridge

Other: _____

Primary:

Input Voltage Range: _____ Desired Inductance (if known): _____

Turns Ratio (if known): _____ Input Current (if known): _____

Other: _____

Secondary(ies):	S1	S2	S3	S4	S5	S6
Output Voltage:	_____	_____	_____	_____	_____	_____
Output Current:	_____	_____	_____	_____	_____	_____
Diode Drop:	_____	_____	_____	_____	_____	_____

MECHANICAL

Mounting Type: Surface Mount Through-Hole Other: _____

Maximum Size: Length: _____ Width: _____ Height: _____

SAFETY & ENVIRONMENTAL REQUIREMENTS

Agency Requirement: IEC: _____ UL: _____ CSA: _____

Insulation Class: Functional Basic Supplementary Reinforced

Dielectric Withstanding Voltage (DWV): _____ DC RMS

Ambient Temperature Range: _____ °C Temperature Rise, MAX: _____ °C

Lead/Terminal Finish: Tin/Lead Pure Tin Other: _____

OTHER

Production Start Date _____

EAU or QTY to be Quoted _____

Target Price (USD) _____

Part Number _____

Competitor Part Number _____

Application _____

Program Name _____

Restricted/ITAR: Yes No

