

PRODUCT NO	SEAGATE PART NO
10053668-001LF	100361017
10053668-002LF	100504880

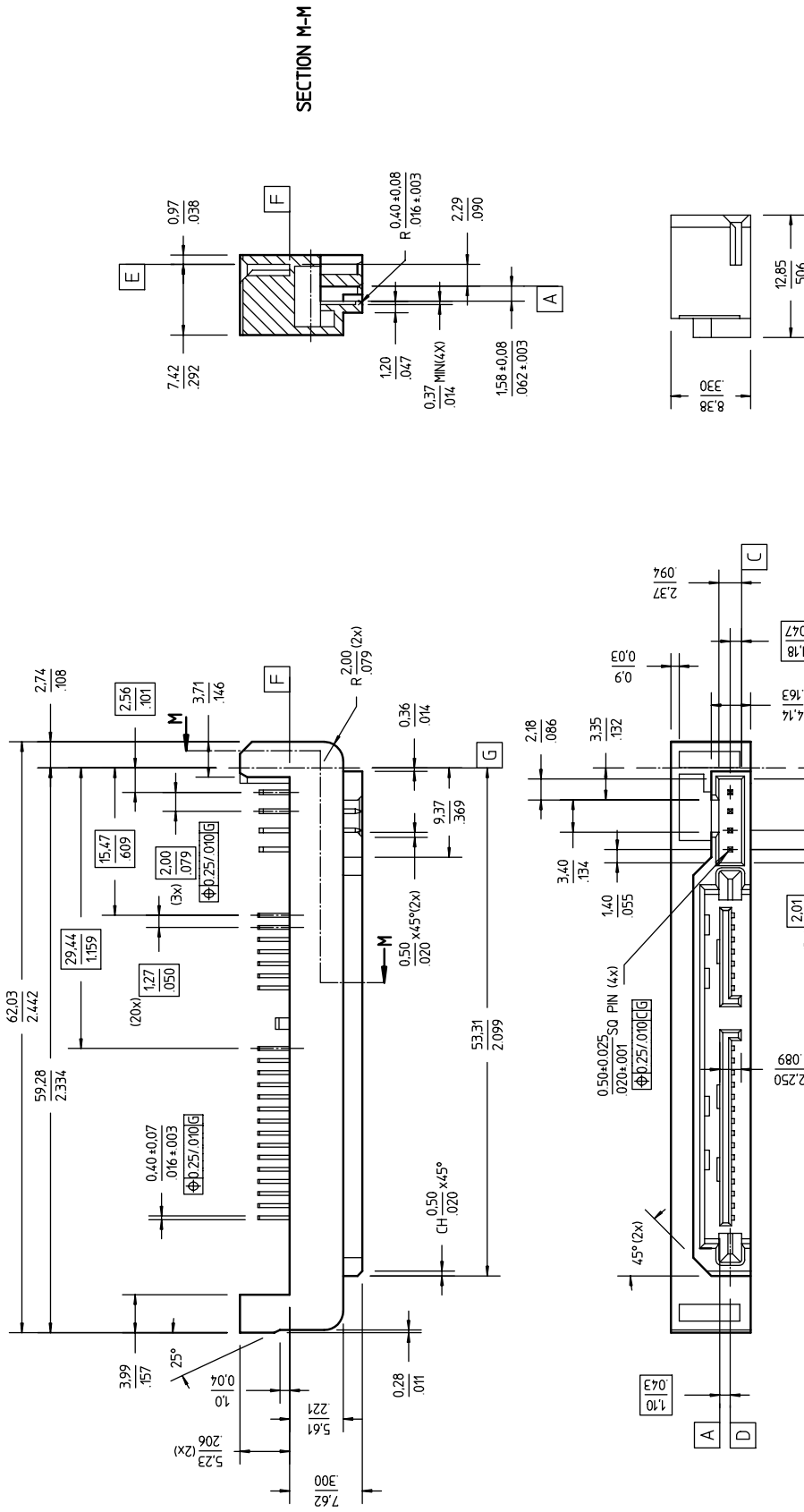

mat'l. code		surface	tolerance	projection	product family	SATA PLUG
ISO 1302	ISO 406 ISO 1101	ISO 1302	ISO 406 ISO 1101	1st angle	title	SATA COMBO PLUG
tolerances unless otherwise specified	linear	xx ± 0.25	xx ± 0.13	mm	dwg no	10053668
angles	3°	x.xxx ± 0.05	x.xxx ± 0.05	scale	sheet 1 of 4 size	A4
dr	R. CRASTA	2005-09-22	2005-09-22	15:1	CUSTOMER	Drawing
engr	R. CRASTA	2008-04-22	2008-04-22			
chr	R. CRASTA	2008-04-22	2008-04-22			
appd	JOEY NG	2008-04-22	2008-04-22			
sheet index	revision sheet					

PRODUCT NO
SEE TABLE

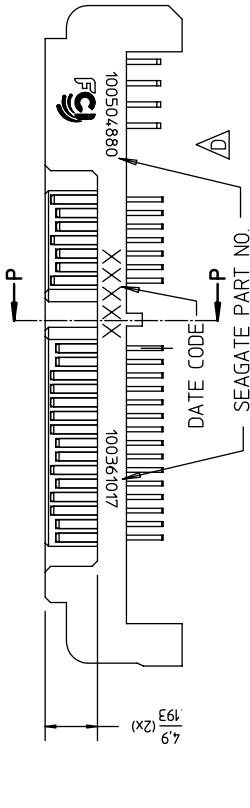

DATE CODE

SEAGATE PART NO.

SEC P-P

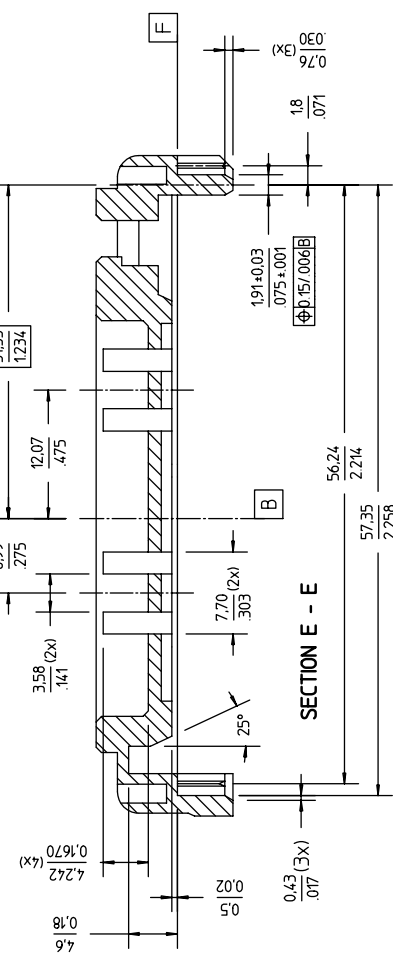
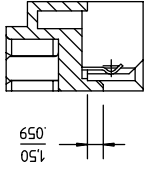

SECTION E - E

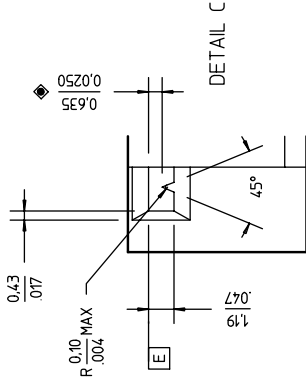
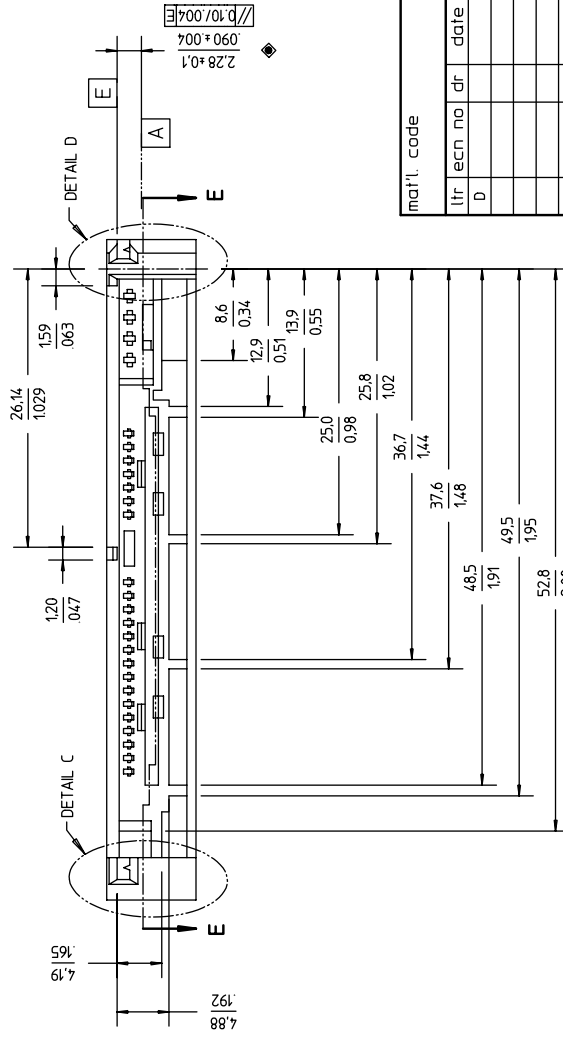

DETAIL C

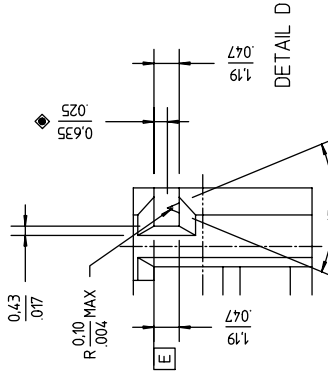

DETAIL D

mat'l. code		surface		tolerance		projection		product family	
itr	ecn no	dr	date	ISO 1302	ISO 406 ISO 1101	mm		SATA PLUG	
D				tolerances unless otherwise specified		scale 15:1		SATA COMBO PLUG	
				angles	linear			title	
				dr	R. CRASTA	2005-09-22		dwg no	
				engr	R. CRASTA	2008-04-22		10053668	
				chr	R. CRASTA	2008-04-22		sheet 2 of 4 size	
				appd	JOEY NG	2008-04-22		A4	
sheet index		revision sheet		CUSTOMER		Drawing		type	

PRODUCT NO
SEE TABLE

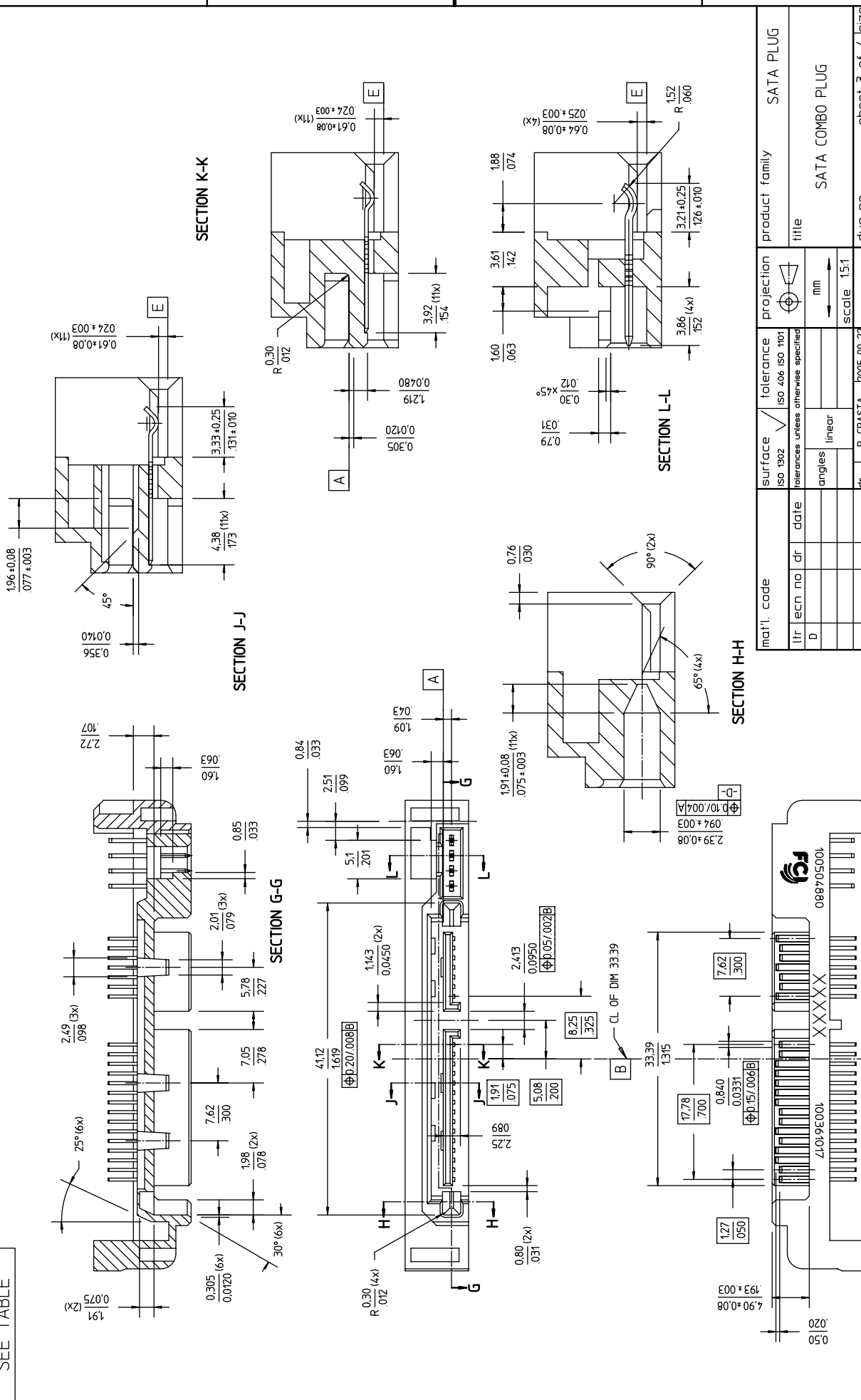

mat'l. code		surface	tolerance	projection	product family	SATA PLUG
ISO 1302	ISO 406 ISO 1101	ISO 15:1	mm	mm	SATA COMBO PLUG	
tolerances unless otherwise specified		angles	linear	scale		
dr	R. CRASTA	2005-09-22				
engr	R. CRASTA	2008-04-22				
chr	R. CRASTA	2008-04-22				
appd	JOEY NG	2008-04-22				
sheet	revision					
index	sheet					

dwg no		10053668
type		CUSTOMER Drawing
sheet 3 of 4 size		A4