

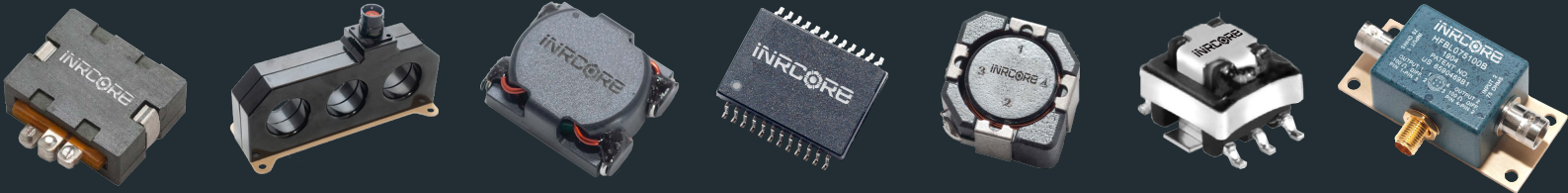

2020 PRODUCT CATALOG

www.inrcore.com



inRCORE



**AS 9100D
CERTIFIED
ISO 9001**

iNRCORE

iNRCORE designs and manufactures magnetic components that transmit high-speed, mission-critical signal and power in the harshest operating conditions. Our solutions have operated on the frontlines of defense to the frontiers of space exploration. For over 70 years, iNRCORE has deployed reliable and intelligent solutions to power next-generation systems.

Our expert engineering teams and award-winning quality and service exceed our customer demanding expectations. Whether we are working to assemble a component to meet your custom design or screening your products to qualify for a critical mission, iNRCORE's solutions are Rugged to the Core.



OUR MISSION

- To serve Defense, Aerospace, Space and High-Performance Industrial customers with the highest level of service focusing on building relationships with mutual benefits.
- To design and manufacture magnetic solutions exceeding customers' satisfaction in terms of quality, reliability and delivery.
- To be competitive while remaining a world-class source for specialty solutions.

Table of Contents

iNRCORE Signal Products Pages 4- 12

| | |
|--|---------|
| IEEE 1394B Firewire Transceiver Line | Page 4 |
| Copperhead™ Series Transceiver Line Interface Modules (Active) | Page 5 |
| Copperhead™ High Speed Dual Transformers (Dual Passive) | Page 5 |
| Copperhead™ High Speed Single Transformers (Single Passive) | Page 5 |
| Digital Video Isolation Transformers (3G and Standard) | Page 5 |
| SMPTTE Digital Video Baluns (3G and Standard) | Page 5 |
| High-Frequency Balun Adaptors | Page 6 |
| Ethernet/AFDX (10/100) | Page 7 |
| Ethernet/AFDX (10/100/1000/10000) | Page 8 |
| High Isolation Ethernet (10KV) | Page 9 |
| MIL-STD-1553 Interface Transformers (Non-QPL) | Page 10 |
| MIL-STD-1553 Interface Transformers (Low Profile and Stacked) | Page 11 |
| MIL-STD-1553 Interface Transformers (Low Profile Miniature Series) | Page 11 |
| QPL Series - Qualified to MIL-PRF-21038/27 | Page 11 |
| PULSE Transformer/Data Transformer/CAN BUS | Page 12 |

iNRCORE Power Products Pages 13-18

| | |
|--|---------|
| Toroid Power Inductors (SLED Series) | Page 13 |
| SMT Common Mode Chokes (SLIC Series) | Page 13 |
| SMT Power Inductors (SLIC, HCCI-80) Series | Page 14 |
| SMT Power Inductors (Toroid, SLED Series) | Page 14 |
| SMT Power Inductors (Toroid, POGO Series) | Page 14 |
| SMT Common Mode Inductors (POGO Series) | Page 15 |
| SMT Power Inductors (Shielded Drum Core) | Page 15 |
| SMT Planar Power Inductors | Page 17 |
| High Frequency Planar Power Transformers | Page 18 |
| SMT Current Sense Transformers | Page 20 |
| Audio Transformers | Page 21 |
| Gate Drive Transformers | Page 21 |

Custom Capabilities & Designer Worksheets Page 22-25

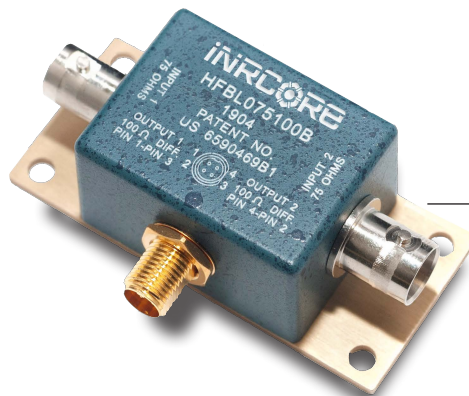

SMPTE Video Balun Adaptor
HFBL075100B (pg. 6)

INRCORE SIGNAL PRODUCTS

iNRCORE has a full line of **High-Speed Transformers** supporting Ethernet IEEE802.x, AFDX systems, SMPTE Serial Video, Fibre Channel and IEEE1394b applications. A unique line of **Line Interface Transceivers** supports a wide range of cable impedances and data rates up to 2.125 Gbps. iNRCORE's products have been utilized for a variety of applications, from Fighter Jets to Space programs. iNRCORE continues to offer tin/lead termination finishes for Military, Space and Aerospace applications requiring the highest grade of reliability.

Parts can also be purchased with pure tin lead finishes where RoHS and REACH compliance are required. In addition to providing this full catalog of off-the-shelf products, more than 50% of iNRCORE's business is customizing parts to customer requirements. iNRCORE can provide custom design services, as well as perform specialized screening and qualification testing.

COPPERHEAD™ SERIES TRANSCEIVER LINE INTERFACE MODULES - ACTIVE

High Speed Data and Communications over 100+ Meters of Copper

- | Military temperature range -55°C to +125°C
- | Low transmit/receive jitter
- | Low power dissipation; 450 mW typical
- | ECL or CML logic interface
- | 1500V Isolation Voltage
- | Surface mount – pick-and-place compatible
- | Withstands infrared and vapor phase soldering 225°C MAX Temperature

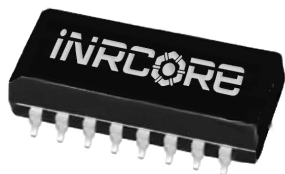

ORDERING INFORMATION

TM 531 D S A 1 (XX)

- (XX) - Custom Product Designator
- blank - No transmit driver
- 1 - 1100 mV output transmit driver and military temperature range
- 2 - 1100 mV output transmit driver and industrial temperature range
- 5 - Active cable equalizer circuit
- A - 5.00 Volt
- B - 3.30 Volt
- S - Impedance matched for STP and twinax (150 ohm)
- U - Impedance matched for unshielded twisted pair (100 ohm)
- V - Impedance matched for video and mini-coax (75 ohm)
- C - Impedance matched for coax (50 ohm)
- D - Gull wing DIP 28-pin package: 0.800"L x 0.400"W x 0.200"H
- F - Gull wing flat pack 28-pin package: 0.760"L x 0.610"W x 0.125"H
- H - Gull wing half DIP 16-pin package: 0.500"L x 0.300"W x 0.180"H
- 133 - 132.8125 Mbaud version 1/8 Speed Fibre Channel/ATM
- 266 - 265.625 Mbaud version 1/4 Speed Fibre Channel
- 531 - 531.25 Mbaud version 1/2 Speed Fibre Channel
- 1062 - 1.0625 Gbaud version Full Speed Fibre Channel
- 1250 - 1.250 Gbaud version, Gigabit Ethernet (both short haul and long haul)
- 1485 - 1.485 Gbaud version, SMPTE

IEEE 1394B FIREWIRE TRANSCEIVER LINE INTERFACE MODULES

| Part Number | Transmitter/Receiver Data Rate | | Transmitter Differential Signal Level - V _{OUT} (mV) | | | Total Power Dissipation (mW) | | Receiv Turns Ratio | Receive Primary Inductance-Lm(uH) | Receive Insertion Loss (dB) | Transmit/Receive Return Loss (dBMIN) | Package L/W/H (in.) | Data Sheet | IEEE 1394B Speed |
|--------------|--------------------------------|------|---|------|------|------------------------------|-----|--------------------|-----------------------------------|-----------------------------|--------------------------------------|---------------------|------------|------------------|
| | MIN | MAX | MIN | TYP | MAX | (mW) | TYP | MIN | (dBMax) | (dBMIN) | | | | |
| TM1062TXDUA | 246 | 1062 | 1200 | 1300 | 1500 | 232 | 1:1 | 4.5 | -2 | -12 | .800 / .400 / .200 | M103 | S200-S800 | |
| TM1062TXHUA | 246 | 1062 | 1200 | 1300 | 1500 | 232 | 1:1 | 4.5 | -2 | -12 | .510 / .300 / .140 | M103 | S200-S800 | |
| TM1062TX3DUA | 246 | 1062 | 1200 | 1300 | 1500 | 700 | 1:1 | 4.5 | -2 | -12 | .800 / .400 / .185 | M103 | S200-S800 | |
| TM125TXHUA | 98 | 246 | 1200 | 1300 | 1500 | 232 | 1:1 | 40 | -2 | -12 | .510 / .300 / .140 | M186 | S100-S200 | |
| TM1062DUXB | 246 | 1062 | 1200 | 1300 | 1500 | 232 | 1:1 | 4.5 | -2 | -12 | .800 / .400 / .200 | M186 | S200-S800 | |
| TM1062HUXB | 246 | 1062 | 1200 | 1300 | 1500 | 232 | 1:1 | 4.5 | -2 | -12 | .510 / .300 / .140 | M186 | S200-S800 | |
| TM1062DU3XB | 246 | 1062 | 1200 | 1300 | 1500 | 232 | 1:1 | 4.5 | -2 | -12 | .800 / .400 / .200 | M186 | S200-S800 | |
| TM125TXHUA | 98 | 246 | 1200 | 1300 | 1500 | 232 | 1:1 | 40 | -2 | -12 | .510 / .300 / .140 | M186 | S100-S200 | |

* Parts listed on data sheet M103 are manufactured in the United States. Data sheet M186 contains equivalent parts manufactured in China.

- View stock and download literature on the web at <http://www.inrcore.com> - On the Home page, "Search by Part Number"
- Applications: Fibre Channel, Gigabit Ethernet, SONET, HDTV, IEEE 1394B, SMTPE.
- iNRCORE's standard lead finish is tin/lead (Sn63/Pb37). Parts can be ordered Non-Lead by adding the suffix "NL" to the part number (i.e. TM1062DUXBNL).
- To order in Tape & Reel packaging, add the suffix "T" to the part number (i.e. TM1062DUXBT)



COPPERHEAD™ HIGH SPEED DUAL TRANSFORMERS - PASSIVE

| Part Number | Package L/W/H (in.) | Turns Ratio (±5%) | Primary Inductance (µH MIN) | Rise Time (ps: MAX @20-80%) | DC Resistance (Ω MAX) | Hipot (Vrms MIN) | Insertion Loss (dB MAX) | Application Nominal Bit Rate (Mbps) | Data Sheet |
|-------------|---------------------|-------------------|-----------------------------|-----------------------------|-----------------------|------------------|-------------------------|-------------------------------------|------------|
| T-330SCT | .500/.435/.180 | 1CT:1CT | 26.0 | 350 | 0.2 | 1500 | -1.5 (15-165 MHz) | 265.6 (quarter speed) | M105 |
| T-531SCT | .500/.375/.235 | 1CT:1CT | 7.5 | 325 | 0.2 | 1500 | -2.0 (50-265 MHz) | 531 (half speed) | M105 |
| T-1062SCT | .500/.435/.180 | 1CT:1CT | 3.75 | 280 | 0.2 | 1500 | -2.0 (100-531 MHz) | 1062.50 (full speed) | M105 |
| T-1250SCT | .500/.435/.180 | 1CT:1CT | 3.75 | 280 | 0.2 | 1500 | -2.0 (125-650MHz) | 1,250 (Gigabit Ethernet) | M105 |
| T-1485SCT | .500/.435/.180 | 1CT:1CT | 3.75 | 280 | 0.2 | 1500 | 1,485 (SMPTE) | 1,485 (SMPTE) | M105 |
| T-3200SCT | .500/.375/.235 | 1:1 | 0.70 | 280 | 0.2 | 1500 | -4.5 (500-1600MHz) | 3200 | M105 |

COPPERHEAD™ HIGH SPEED SINGLE TRANSFORMERS - PASSIVE

| Part Number | Package L/W/H (in.) | Turns Ratio (±5%) | Primary Inductance (µH MIN) | Rise Time (ps: MAX @20-80%) | DC Resistance (Ω MAX) | Hipot (Vrms MIN) | Insertion Loss (dB MAX) | Application Nominal Bit Rate (Mbps) | Data Sheet |
|-------------|---------------------|-------------------|-----------------------------|-----------------------------|-----------------------|------------------|-------------------------|-------------------------------------|------------|
| T-330ACT | .230/.265/.215 | 1CT:1CT | 26.0 | 350 | 0.2 | 1500 | -1.5 (15-165 MHz) | 265.5 (quarter speed) | M131 |
| T-531ACT | .230/.265/.215 | 1CT:1CT | 7.5 | 325 | 0.2 | 1500 | -2.0 (100-265 MHz) | 531 (half speed) | M131 |
| T-1062ACT | .230/.265/.215 | 1CT:1CT | 3.75 | 280 | 0.2 | 1500 | -2.0 (100-531 MHz) | 1,062.5 (full speed) | M131 |
| T-1250ACT | .230/.265/.215 | 1CT:1CT | 3.75 | 280 | 0.2 | 1500 | -2.0 (200-620 MHz) | 1,250 (Gigabit Ethernet) | M131 |
| T-1485ACT | .230/.265/.215 | 1CT:1CT | 3.75 | 280 | 0.2 | 1500 | -2.0 (200-742.5 MHz) | 1,485 (SMPTE) | M131 |

HIGH-FREQUENCY SMT BALUNS

| Part Number | Impedance Unbalanced (Ω) | Impedance Balanced (Ω) | Insertion Loss (dB MAX) 1.0 MHz - 1.485Gbps | Return Loss (dB MIN) 1.0 MHz - 1.485Gbps | Datasheet |
|-------------|--------------------------|------------------------|---|--|-----------|
| T-050078 | 50 | 78 | -2 | 12 | M132 |
| T-050100 | 50 | 100 | -2 | 12 | M132 |
| T-050150 | 50 | 150 | -2 | 12 | M132 |
| T-075100 | 75 | 100 | -2 | 12 | M132 |

• Designed for standard test equipment with SMA connectors. Wide bandwidth: 1.0 MHz to 1.2GHz.

SMPTE DIGITAL VIDEO BALUNS - 3G AND STANDARD (1.485Gbps)

| Part Number | Package L/W/H (in.) | Data Rate (Gbps) | Impedance Unbalanced (Ω) | Impedance Balanced (Ω) | Insertion Loss (dB MAX) @1.5GHz | Return Loss (dB MIN) @1.5GHz | Data Sheet |
|-------------|---------------------|------------------|--------------------------|------------------------|---------------------------------|------------------------------|------------|
| TA-0751003G | .290/.240/.150 | 2.973 | 75 | 100 | -2.0 | 12.0 | M551 |
| TA-0751503G | .290/.240/.150 | 2.973 | 75 | 150 | -2.0 | 10.0 | M551 |
| TA-0501003G | .290/.240/.150 | 2.973 | 50 | 100 | -2.0 | 10.0 | M551 |
| TA-075100G | .290/.240/.150 | 1.485 | 75 | 100 | -2.0 | 12.0 | M551 |
| TA-075150G | .290/.240/.150 | 1.485 | 75 | 150 | -2.0 | 10.0 | M551 |
| TA-050100G | .290/.240/.150 | 1.485 | 50 | 100 | -2.0 | 10.0 | M551 |

- View stock and download literature on the web at <http://www.inrcore.com> - On the Home page, "Search by Part Number"
- Dual Transformers are designed specifically for Point-to-Point Communication using STP, QUADRIX or TWINAX cable (comparable with 50,75,100 & 150Ω cable)
- Applications: Fibre Channel, Gigabit Ethernet, SONET, HDTV, IEEE 1394B, SMPTE.
- iNRCORE's standard lead finish is tin/lead (Sn63/Pb37). Parts can be ordered Non-Lead by adding "NL" to the part number (i.e. T-1250ACTNL).
- To order in Tape & Reel packaging, add the suffix "T" to the part number (i.e. T-330ACTT)

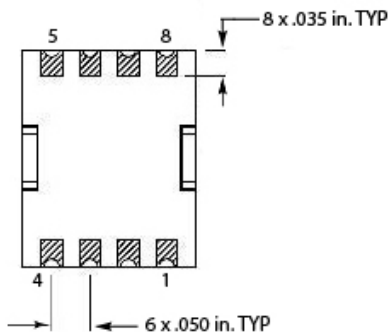
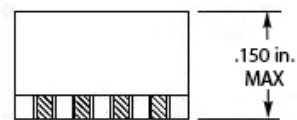
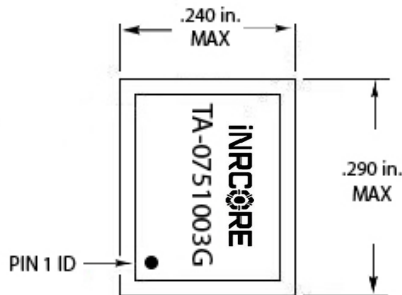
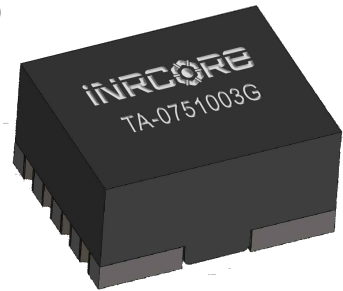

INSTRUMENTATION BALUN ADAPTERS

| Part Number | Impedance Unbalanced (Ω) | Impedance Balanced (Ω) 1.485Gbps | Insertion Loss (dB MAX) 1.485Gbps | Return Loss (dB MIN) 1.0MHz -1.2 GHz | Datasheet |
|-------------|-----------------------------------|--|--------------------------------------|---|-----------|
| HFB050150 | 50 | 150 | -2 | 15 | M100 |
| HFB050100 | 50 | 100 | -2 | 15 | M100 |

- Transforms 150 Ω or 100 Ω , balanced, differential signal, to 50 Ω single-ended signal.
- Designed for standard test equipment with SMA connectors. Wide bandwidth: 1.0 MHz to 1.2GHz.

SMPTE VIDEO BALUN ADAPTORS - STANDARD (1.485Gbps)

| Part Number | Unbalanced (Ω) | Impedance Balanced (Ω) | Insertion Loss dB MAX (1.485 Gbps) | Jitter Dj (pSec. MAX) 1.485 Gbps | Bracket | Datasheet |
|----------------|-------------------------|---------------------------------|---------------------------------------|-------------------------------------|---------|-----------|
| HFB075100A | 75 | 100 | -2.0 | 110.0 | NO | M146 |
| HFB075100B | 75 | 100 | -2.0 | 110.0 | NO | M146 |
| HFB075150A | 75 | 150 | -2.0 | 110.0 | NO | M146 |
| HFB075150B | 75 | 150 | -2.0 | 110.0 | NO | M146 |
| HFBL075100A | 75 | 100 | -2.0 | 110.0 | YES | M146 |
| HFBL075100B | 75 | 100 | -2.0 | 110.0 | YES | M146 |
| HFBL075150A | 75 | 150 | -2.0 | 110.0 | YES | M146 |
| HFBL075150B | 75 | 150 | -2.0 | 110.0 | YES | M146 |
| HFBM075100B | 75 | 100 | -2.0 | 110.0 | YES | M147 |
| HFBM075100C * | 75 | 100 | -2.0 | 110.0 | YES | M147 |
| HFBM075100S ** | 75 | 100 | -2.0 | 110.0 | YES | M305 |
| HFBM075100L | 75 | 100 | -2.0 | 110.0 | YES | M265 |
| HFB075100D | 75 | 100 | -2.0 | 110.0 | YES | M283 |

- Transforms 100 Ω or 150 Ω balanced differential signal to 75 Ω , grounded, unbalanced signal.
 - Designed for SMPTE-292M. HDTV application at 1.485Gbps data rate.
- * HFBM075100C - 75 Ω Connectors: Triax Ω , Trompeter BJ770
 ** HFBM075100S - 75 Ω Connectors: BNC

SMPTE VIDEO BALUN ADAPTORS - 3G

| Part Number | Unbalanced (Ω) | Impedance Balanced (Ω) | Insertion Loss (dB MAX) 2.973 Gbps | Jitter Dj (pSec. MAX) 2.973 Gbps, PN 7 | Bracket | Datasheet |
|---------------|-------------------------|---------------------------------|---------------------------------------|---|---------|-----------|
| HFB3G075100A | 75 | 100 | -6.5 | 65.0 | NO | M416 |
| HFB3G075100B | 75 | 100 | -6.5 | 65.0 | NO | M416 |
| HFB3GL075100A | 75 | 100 | -6.5 | 65.0 | YES | M416 |
| HFB3GL075100B | 75 | 100 | -6.5 | 65.0 | YES | M416 |
| HFB3G075150A | 75 | 150 | -6.5 | 65.0 | NO | M416 |
| HFB3G075150B | 75 | 150 | -6.5 | 65.0 | NO | M416 |
| HFB3GL075150A | 75 | 150 | -6.5 | 65.0 | YES | M416 |
| HFB3GL075150B | 75 | 150 | -6.5 | 65.0 | YES | M416 |

- Transforms 100 Ω or 150 Ω balanced differential signal to 75 Ω , grounded, unbalanced signal.
- Designed for SMPTE-424M/425M, 2,973Gbps.

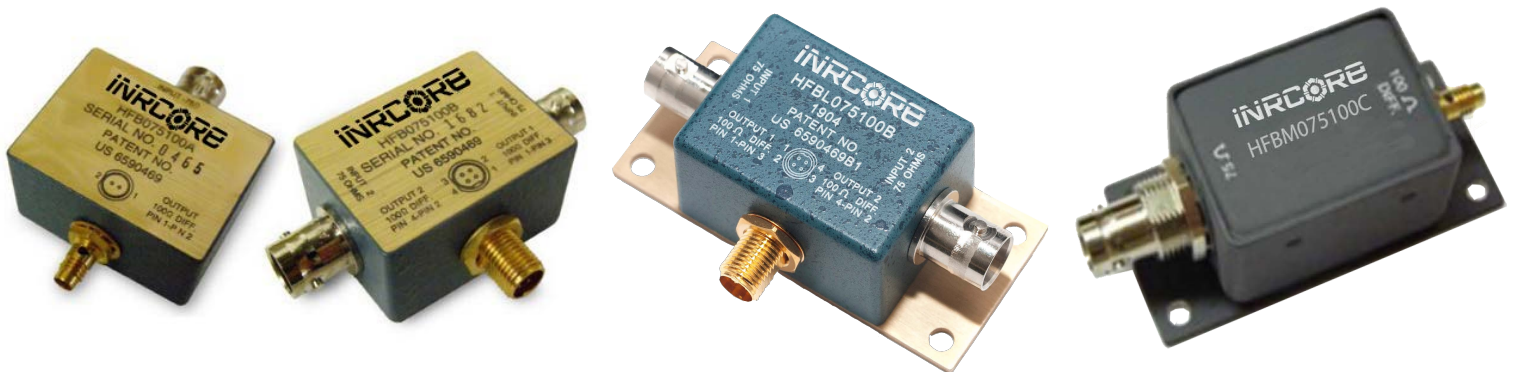

| INRCORE ETHERNET / AFDX | | | | | | | |
|-------------------------|-------------|-------------|---------------|------------|-----------------|-----------------|------------|
| 10/100Base-TX | | | | | | | |
| Number of Ports | Part Number | Turns Ratio | Configuration | | Style | Package | Data Sheet |
| | | | RX | TX | | | |
| Single | 100B-1001 | 1CT:1CT | T,C | T,C,S | 12-pin SMT | .630/.470/.200 | M101 |
| | 100B-1001X | 1CT:1CT | T,C | T,C,S | 12-pin SMT | .630/.470/.200 | M101 |
| | 100B-1001F | 1CT:1CT | T,C | T,C,S | 12-pin SMT | .630/.470/.200 | M101 |
| | 100B-1001FX | 1CT:1CT | T,C | T,C,S | 12-pin SMT | .630/.470/.200 | M101 |
| | 100B-1003 | 1CT:1CT | T,C | T,C | 16-pin SMT | .500/.265/.235 | M101 |
| | 100B-1003X | 1CT:1CT | T,C | T,C | 16-pin SMT | .500/.265/.235 | M101 |
| | 100B-1018 | 1CT:1CT | T,C | T,C,S | 12-pin SMT | .583/.470/.180 | M189 |
| | 100B-1018X | 1CT:1CT | T,C | T,C,S | 12-pin SMT | .583/.470/.180 | M189 |
| | 100B-1027 | 1CT:1CT | T,C | T,C,S | 16-pin SMT | 1.00/.390/.235 | M197 |
| | 100B-1027X | 1CT:1CT | T,C | T,C,S | 16-pin SMT | 1.00/.390/.235 | M197 |
| | 100B-1035 | 1CT:1CT: | T,C | T,C | 12-pin SMT | .500/.347/.088 | M316 |
| | 100B-1051 | 1CT:1CT | T,C | T,C | 24-pin SMT | .590/.520/.155 | M440 |
| | 100B-1054X | 1CT:1CT | T,C | T,C | 16-pin SMT | .500/.358/.236 | M441 |
| Dual | 100B-2002 | 1CT:1CT | T, C | T,C | 24-pin SMT | .518/.595/.241 | M110 |
| | 100B-2002X | 1CT:1CT | T, C | T,C | 24-pin SMT | .518/.595/.241 | M110 |
| | 100B-2002F | 1CT:1CT | T, C | T,C | 24-pin SMT | .518/.595/.241 | M110 |
| | 100B-2002FX | 1CT:1CT | T, C | T,C | 24-pin SMT | .518/.595/.241 | M110 |
| Quad | 100B-4005 | 1CT:1CT | T,C | T,C | 40-pin SMT | 1.125/.480/.280 | M203 |
| | 100B-4005X | 1CT:1CT | T,C | T,C | 40-pin SMT | 1.120/.480/.280 | M203 |
| | 100B-4005F | 1CT:1CT | T,C | T,C | 40-pin SMT | 1.125/.480/.280 | M203 |
| | 100B-4005FX | 1CT:1CT | T,C | T,C | 40-pin SMT | 1.120/.480/.280 | M203 |
| | 100B-4009 | 1CT:1CT | T,C | T,C | 40-pin SMT | 1.125/.480/.280 | M190 |
| | 100B-4009X | 1CT:1CT | T,C | T,C | 40-pin SMT | 1.125/.480/.280 | M190 |
| | 100B-4009F | 1CT:1CT | T,C | T,C | 40-pin SMT | 1.125/.480/.280 | M190 |
| | 100B-4009FX | 1CT:1CT | T,C | T,C | 40-pin SMT | 1.125/.480/.280 | M190 |
| | 100B-4011 | 1CT:1CT | T,C | T,C | 40-pin SMT | 1.125/.480/.280 | M151 |
| | 100B-4011X | 1CT:1CT | T,C | T,C | 40-pin SMT | 1.125/.480/.280 | M151 |
| | 100B-4011F | 1CT:1CT | T,C | T,C | 40-pin SMT | 1.125/.480/.280 | M151 |
| | 100B-4011FX | 1CT:1CT | T,C | T,C | 40-pin SMT | 1.125/.480/.280 | M151 |
| | 100B-4018 | 1CT:1CT | T,C | T,C | 40-pin SMT | 1.110/.630/.225 | M448 |
| | 100B-4019 | 1CT:1CT | T,C | T,C | 40-pin SMT | 1.08/.630/.226 | M449 |
| 100B-4020 | 1CT:1CT | C,T,C | C,T,C | 40-pin SMT | 1.090/.360/.236 | M307 | |

- View stock and download literature on the web at <http://www.inrcore.com> - On the Home page, "Search by Part Number"
- iNRCORE's standard lead finish is Tin/Lead (Sn63/Pb37). Parts can be ordered Non-Lead by adding "NL" to the part number (i.e. 100B-2002XNL).
- To order in Tape & Reel packaging, add the suffix "T" to the part number (i.e. 100B-4009FT)

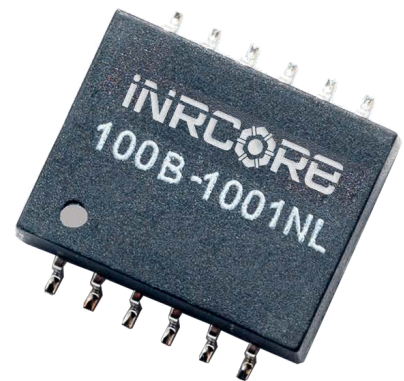
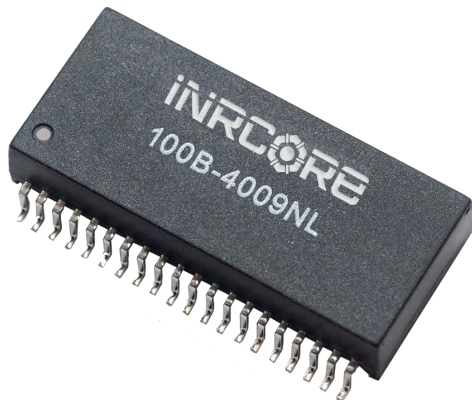

| INRCORE ETHERNET / AFDX | | | | | | | |
|-------------------------|-------------------|-------------|---------------|------------|----------------|-----------------|------------|
| 1000Base-T / 10GBase-T | | | | | | | |
| Number of Ports | Part Number | Turns Ratio | Configuration | | Style | Package | Data Sheet |
| | | | RX | TX | | | |
| Single | 1000B-5001 | 1CT:1CT | T,C,S | T,C,S | 24-pin SMT | .695/.635/.230 | M1061 |
| | 1000B-5001X | 1CT:1CT | T,C,S | T,C,S | 24-pin SMT | .695/.635/.230 | M1061 |
| | 1000B-5001F | 1CT:1CT | T,C,S | T,C,S | 24-pin SMT | .695/.635/.230 | M1061 |
| | 1000-5001FX | 1CT:1CT | T,C,S | T,C,S | 24-pin SMT | .695/.635/.230 | M1061 |
| | 1000B-5002 | 1CT:1CT | T,C | T,C | 24-pin SMT | .695/.635/.230 | M106 |
| | 1000B-5002X | 1CT:1CT | T,C | T,C | 24-pin SMT | .695/.635/.230 | M106 |
| | 1000B-5002F | 1CT:1CT | T,C | T,C | 24-pin SMT | .695/.635/.230 | M106 |
| | 1000B-5002FX | 1CT:1CT | T,C | T,C | 24-pin SMT | .695/.635/.230 | M106 |
| | 1000B-5004 | 1CT:1CT | T,C,S | T,C,S | 24-pin SMT | .705/.490/.190 | M428 |
| | 1000B-5009 | 1CT:1CT | T | T | 24-pin SMT | .600/.430/.340 | M160 |
| | 1000B-5009X | 1CT:1CT: | T | T | 24-pin SMT | .600/.430/.340 | M160 |
| | 1000B-5010 (PoE) | 1CT:1CT | T,C,S | T,C,S | 24-pin SMT | .690/.480/.225 | M290 |
| | 1000B-5010X (PoE) | 1CT:1CT | T,C,S | T,C,S | 24-pin SMT | .690/.480/.225 | M290 |
| | 1000B-5012 | 1CT:1CT | T | T | 24-pin SMT | .735/.518/.241 | M160 |
| | 1000B-5012X | 1CT:1CT | T | T | 24-pin SMT | .735/.518/.241 | M160 |
| | 1000B-5016 | 1CT:1CT | T | T | 24-pin SMT | .600/.405/.163 | M160 |
| | 1000B-5017 | 1CT:1CT | T,C | T,C | 24-pin SMT | .715/.480/.260 | M429 |
| | 1000B-5017F | 1CT:1CT | T,C | T,C | 24-pin SMT | .715/.480/.260 | M429 |
| | 1000B-5026F | 1CT:1CT | T,C | T,C | 24-pin SMT | .705/.480/.180 | M430 |
| | 1000B-5027 (PoE) | 1CT:1CT | T,C,S | T,C,S | 24-pin SMT | .695/.480/.180 | M238 |
| | 1000B-5027X (PoE) | 1CT:1CT | T,C,S | T,C,S | 24-pin SMT | .695/.480/.180 | M238 |
| | 1000B-5028X | 1CT:1CT | T | T | 24-pin SMT | .600/.300/.163 | M431 |
| | 1000B-5028FX | 1CT:1CT | T | T | 24-pin SMT | .600/.300/.163 | M431 |
| | 1000B-5029 | 1CT:1CT | T,C | T,C | 24-pin SMT | .700/.620/.185 | M285 |
| | 1000B-5029X | 1CT:1CT | T,C | T,C | 24-pin SMT | .700/.620/.185 | M285 |
| | 1000B-5033 | 1CT:1CT | T,C | T,C | 24-pin SMT | .600/.430/.340 | M433 |
| | 1000B-5033X | 1CT:1CT | T,C | T,C | 24-pin SMT | .600/.430/.340 | M433 |
| | 1000B-5035 | 1CT:1CT | T,C,S | T,C,S | 24-pin SMT | .736/.537/.225 | M434 |
| | 1000B-5036 (PoE) | 1CT:1CT | T,C | T,C | 24-pin SMT | .725/.490/.265 | M435 |
| | 1000B-5037 (PoE) | 1CT:1CT | T,C | T,C | 24-pin SMT | .725/.633/.410 | M436 |
| | 1000B-5042 | 1CT:1CT | T,C | T,C | 24-pin SMT | .510/.520/.155 | M437 |
| | 1000B-5045X | 1CT:1CT | T,C | T,C | 24-pin SMT | .725/.490/.265 | M438 |
| | 1000B-5046X | 1CT:1CT | T,C | T,C | 24-pin SMT | .725/.490/.265 | M439 |
| 10GB-6001 | 1CT:1CT | T,C | T,C | 24-pin SMT | .700/.630/.235 | M375 | |
| 10GB-6006 | 1CT:1CT | T,C | T,C | 24-pin SMT | .700/.630/.235 | M555 | |
| 10GB-6007 | 1CT:1CT | T,C | T,C | 24-pin SMT | .790/.760/.100 | M553 | |
| 10GB-6009 | 1CT:1CT | T,C | T,C | 30-pin SMT | .705/.615/.295 | M562 | |
| Dual | 1000B-5003 | 1CT:1CT | T,C | T,C | 50-pin SMT | 1.100/.430/.340 | M106 |
| | 1000B-5003X | 1CT:1CT | T,C | T,C | 50-pin SMT | 1.100/.430/.340 | M106 |
| | 1000B-5003F | 1CT:1CT | T,C | T,C | 50-pin SMT | 1.100/.430/.340 | M106 |
| | 1000B-5003FX | 1CT:1CT | T,C | T,C | 50-pin SMT | 1.100/.430/.340 | M106 |
| | 1000B-5014 | 1CT:1CT | T,C,S | T,C,S | 48-pin SMT | 1.100/.610/.290 | M160 |
| | 1000B-5014X | 1CT:1CT | T,C,S | T,C,S | 48-pin SMT | 1.100/.610/.290 | M160 |
| | 1000B-5020 | 1CT:1CT | T,C | T,C | 48-pin SMT | .100/.610/.290 | M286 |
| | 1000B-5020X | 1CT:1CT | T,C | T,C | 48-pin SMT | .100/.610/.290 | M286 |

- View stock and download literature on the web at <http://www.inrcore.com> - On the Home page, "Search by Part Number"
- iNRCORE's standard lead finish is tin/lead (Sn63/Pb37). Parts can be ordered Non-Lead by adding "NL" to the part number (i.e. 1000B-5003NL).
- To order in Tape & Reel packaging, add the suffix "T" to the part number (i.e. 1000B-5002FXT)
- T = Transformer, C = Choke, S = Shunt inductor
- Standard Operating Temperature: -40°C to +85°C
- Extended Operating Temperature (suffix "X"): -55°C to +125°C
- Parts compliant to IEEE 802.3 standard
- **PoE** = Power of Ethernet Per IEEE 802.3af, 15 W

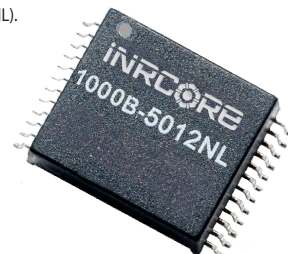

INRCORE ETHERNET/AFDX

High Isolation Ethernet

| Part Number | Insertion Loss (dB MAX) | | | | Return Loss (dB MIN) | | | | | | Crosstalk (dB MIN) | | | | Differential to Common Mode Rejection (dB MIN) | | | | Isolation | Data Sheet |
|-------------|-------------------------|--------|--------|---------|----------------------|--------|--------|--------|--------|---------|--------------------|--------|--------|---------|--|--------|---------|---------|-----------|------------|
| | 0.1 - 30 MHz | 60 MHz | 80 MHz | 100 MHz | 5 MHz | 30 MHz | 50 MHz | 60 MHz | 80 MHz | 100 MHz | 1 MHz | 30 MHz | 60 MHz | 100 MHz | 30 MHz | 60 MHz | 100 MHz | 200 MHz | | |
| X-1644 | -1 | -2 | -2.5 | -4 | -18 | -9 | -5.5 | -4.5 | -3.0 | -2.0 | -45 | -30 | -27 | -25 | -36 | -32 | -30 | -25 | 10K VAC | M215 |
| X-1697 | -1.5 | -3 | -3.5 | -4.5 | -18 | -8 | -5.5 | -4.5 | -3.3 | -2 | -45 | -30 | -27 | -25 | -36 | -32 | -30 | -25 | 10K VAC | M514 |
| 100B-1014 | -1.1 | -1 | / | -1.4 | -20 | -13 | -10 | -9 | -7 | / | -50 | -40 | -40 | -35 | -42 | -37 | -35 | -35 | 6K VAC | M510 |
| 100B-1021 | -1 | -2 | -3 | -4 | -18 | -9 | -5.5 | -4.5 | -3 | -2 | -45 | -30 | -27 | -25 | -36 | -32 | -30 | -25 | 8K VAC | M511 |
| 100B-1044 | -1 | -1 | -1 | -1 | -12 | -12 | -12 | -12 | -10 | -8 | -45 | -30 | -27 | -25 | -36 | -32 | -30 | -25 | 6K VAC | M512 |

- View stock and download literature on the web at <http://www.inrcore.com> - On the Home page, "Search by Part Number"
- INRCORE's standard lead finish is tin/lead (Sn63/Pb37). Parts can be ordered Non-Lead by adding "NL" to the part number (i.e. 100B-1014NL).
- To order in Tape & Reel packaging, add the suffix "T" to the part number (i.e. 100B-1014T)

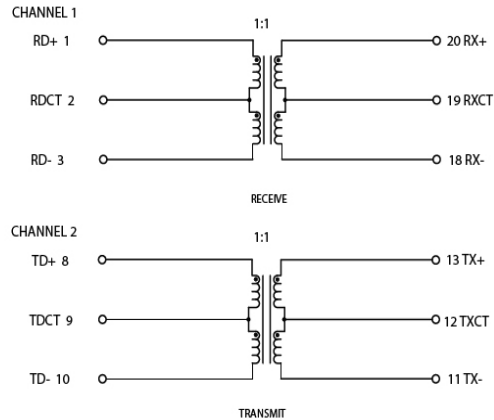
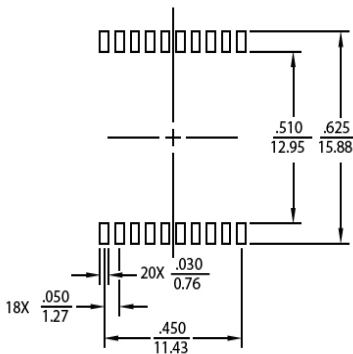
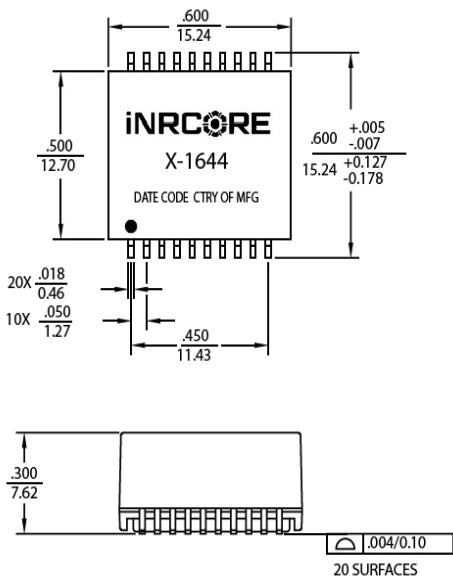
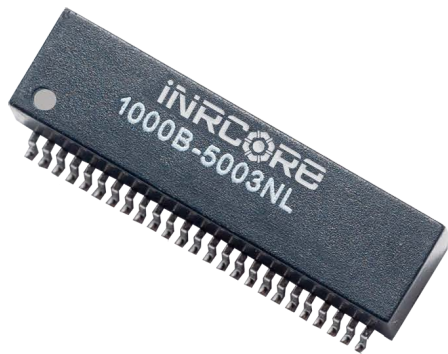

Weight 2.6 grams
 Tube 20/tube
 Tape & Reel 300/reel

Dimensions: Inches
 mm
 Unless otherwise specified, all tolerances are ± .010 / 0.25

MIL-STD-1553 INTERFACE TRANSFORMERS

Non-QPL

| Part Number* | Turns Ratio (±3%) | Impedance (W MIN) | Package L/W/H (in.) | Data Sheet | Part Number* | Turns Ratio (±3%) | Impedance (W MIN) | Package L/W/H (in.) | Data Sheet |
|--------------|-----------------------|-------------------|---------------------|------------|--------------|-----------------------|-------------------|---------------------|------------|
| FL1553-1 | 1CT:1CT/1CT:.707CT | 4,000 | .630/.630/.155 | M227 | STQ1553-3 | 1.25CT:1CT/1.66CT:1CT | 4,000 | .630/.630/.340 | M230 |
| GL1553-1 | 1CT:1CT/1CT:.707CT | 4,000 | .630/.630/.155 | M227 | STQ1553-5 | 1CT:2.12CT/1CT:1.5CT | 4,000 | .630/.630/.340 | M230 |
| TL1553-1 | 1CT:1CT/1CT:.707CT | 4,000 | .630/.630/.155 | M226 | STQ1553-45 | 1.5CT/1CT:1.79CT | 4,000 | .630/.630/.340 | M230 |
| FL1553-2 | 1.4CT:1CT/2CT:1CT | 7,200 | .630/.630/.155 | M227 | SFQ1553-1 | 1CT:1CT/1CT:.707CT | 4,000 | .630/.630/.340 | M231 |
| GL1553-2 | 1.4CT:1CT/2CT:1CT | 7,200 | .630/.630/.155 | M227 | SGQ1553-1 | CT:1CT/1CT:.707CT | 4,000 | .630/.630/.340 | M231 |
| TL1553-2 | 1.4CT:1CT/2CT:1CT | 7,200 | .630/.630/.155 | M226 | SFQ1553-2 | 1.4CT:1CT/2CT:1CT | 7,200 | .630/.630/.340 | M231 |
| FL1553-3 | 1.25CT:1CT/1.66CT:1CT | 4,000 | .630/.630/.155 | M227 | SGQ1553-2 | 1.4CT:1CT/2CT:1CT | 7,200 | .630/.630/.340 | M231 |
| GL1553-3 | 1.25CT:1CT/1.66CT:1CT | 4,000 | .630/.630/.155 | M227 | SFQ1553-3 | 1.25CT:1CT/1.66CT:1CT | 4,000 | .630/.630/.340 | M231 |
| TL1553-3 | 1.25CT:1CT/1.66CT:1CT | 4,000 | .630/.630/.155 | M226 | SGQ1553-3 | 1.25CT:1CT/1.66CT:1CT | 4,000 | .630/.630/.340 | M231 |
| TL1553-5 | 1CT:2.12CT/1CT:1.5CT | 4,000 | .630/.630/.155 | M227 | SFQ1553-5 | 1CT:2.12CT/1CT:1.5CT | 4,000 | .630/.630/.340 | M231 |
| GL1553-5 | 1CT:2.12CT/1CT:1.5CT | 4,000 | .630/.630/.155 | M227 | SGQ1553-5 | 1CT:2.12CT/1CT:1.5CT | 4,000 | .630/.630/.340 | M231 |
| TL1553-5 | 1CT:2.12CT/1CT:1.5CT | 4,000 | .630/.630/.155 | M226 | SFQ1553-45 | 1CT:2.5CT/1CT:1.79CT | 4,000 | .630/.630/.340 | M231 |
| FL1553-45 | 1CT:2.5CT/1CT:1.79CT | 4,000 | .630/.630/.155 | M227 | SGQ1553-45 | 1CT:2.5CT/1CT:1.79CT | 4,000 | .630/.630/.340 | M231 |
| GL1553-45 | 1CT:2.5CT/1CT:1.79CT | 4,000 | .630/.630/.155 | M227 | SLQF1553-1 | 1CT:1CT/1.4CT:1CT | 4000 | .630/.630/.280 | M234 |
| TL1553-45 | 1CT:2.5CT/1CT:1.79CT | 4,000 | .630/.630/.155 | M226 | SLQF1553-2 | 1.4CT:1CT/2CT:1CT | 7,200 | .630/.630/.280 | M234 |
| DFL1553-1 | 1CT:1CT/1CT:.707CT | 4,000 | .930/.630/.155 | M229 | SLQF1553-3 | 1.25CT:1CT/1.66CT:1CT | 4,000 | .630/.630/.280 | M234 |
| DGL1553-1 | 1CT:1CT/1CT:.707CT | 4,000 | .930/.630/.155 | M229 | SLQF1553-5 | 1CT:2.12CT/1CT:1.5CT | 4,000 | .630/.630/.280 | M234 |
| DTL1553-1 | 1CT:1CT/1CT:.707CT | 4,000 | .930/.630/.155 | M228 | SLQF1553-45 | 1CT:2.5CT/1CT:1.79CT | 4,000 | .630/.630/.280 | M234 |
| DFL1553-2 | 1.4CT:1CT/2CT:1CT | 7,200 | .930/.630/.155 | M229 | SLQG1553-1 | 1CT:1CT/1.4CT:1CT | 4,000 | .630/.630/.280 | M234 |
| DGL1553-2 | 1.4CT:1CT/2CT:1CT | 7,200 | .930/.630/.155 | M229 | SLQG1553-2 | 1.4CT:1CT/2CT:1CT | 7,200 | .630/.630/.280 | M234 |
| DTL1553-2 | 1.4CT:1CT/2CT:1CT | 7,200 | .930/.630/.155 | M228 | SLQG1553-3 | 1.25CT:1CT/1.66CT:1CT | 4,000 | .630/.630/.280 | M234 |
| DFL1553-3 | 1.25CT:1CT/1.66CT:1CT | 4,000 | .930/.630/.155 | M229 | SLQG1553-5 | 1CT:2.12CT/1CT:1.5CT | 4,000 | .630/.630/.280 | M234 |
| DGL1553-3 | 1.25CT:1CT/1.66CT:1CT | 4,000 | .930/.630/.155 | M229 | SLQG1553-45 | 1CT:2.5CT/1CT:1.79CT | 4,000 | .630/.630/.280 | M234 |
| DTL1553-3 | 1.25CT:1CT/1.66CT:1CT | 4,000 | .930/.630/.155 | M228 | SLQT1553-1 | 1CT:1CT/1.4CT:1CT | 4,000 | .630/.630/.280 | M234 |
| DFL1553-5 | 1CT:2.12CT/1CT:1.5CT | 4,000 | .930/.630/.155 | M229 | SLQT1553-2 | 1.4CT:1CT/2CT:1CT | 7,200 | .630/.630/.280 | M234 |
| DGL1553-5 | 1CT:2.12CT/1CT:1.5CT | 4,000 | .930/.630/.155 | M229 | SLQT1553-3 | 1.25CT:1CT/1.66CT:1CT | 4,000 | .630/.630/.280 | M234 |
| DTL1553-5 | 1CT:2.12CT/1CT:1.5CT | 4,000 | .930/.630/.155 | M228 | SLQT1553-5 | 1CT:2.12CT/1CT:1.5CT | 4,000 | .630/.630/.280 | M234 |
| DFL1553-45 | 1CT:2.5CT/1CT:1.79CT | 4,000 | .930/.630/.155 | M229 | SLQT1553-45 | 1CT:2.5CT/1CT:1.79CT | 4,000 | .630/.630/.280 | M234 |
| DGL1553-45 | 1CT:2.5CT/1CT:1.79CT | 4,000 | .930/.630/.155 | M229 | X-1584 | 1CT:1.79CT | 3,000 | .500/.350/.172 | M157 |
| DTL1553-45 | 1CT:2.5CT/1CT:1.79CT | 4,000 | .930/.630/.155 | M228 | X-1596 | v1CT:2.5CT | 3,000 | .500/.350/.172 | M157 |
| STQ1553-1 | 1CT:1CT/1CT:.707CT | 4,000 | .630/.630/.340 | M230 | Q1553-71** | 1CT:3CT/1CT:2.15CT | 4,000 | .625/.625/.250 | M128 |
| STQ1553-2 | 1.4CT:1CT/2CT:1CT | 7,200 | .630/.630/.340 | M230 | SMQ1553-70** | 1CT:3CT/1CT:2.15CT | 4,000 | .625/.625/.250 | M128 |

***Choose 1 of 3 Operating Temperature Ranges :**

| Operating Temperature | Flat Pack Prefix | Gull Wing Prefix | Through-Hole Prefix |
|-----------------------|------------------|------------------|---------------------|
| 0° to +70°C | FLC | GLC | TLC |
| -40° to +85°C | FLN | GLN | TLN |
| -55° to +125°C | FL | GL | TL |

Part Number Prefix - Package Types

| | |
|------|---|
| FL | Flat Pack Package |
| GL | Gull Wing Package |
| TL | Through-Hole Package |
| DFL | Dual-Ratio, Dual Interface, Flat Pack Package |
| DGL | Dual-Ratio, Dual Interface, Gull Wing Package |
| DTL | Dual-Ratio, Dual Interface, Through-Hole Package |
| SFQ | Stacked Dual-Ratio, Dual Interface, Flat Pack Package |
| SGQ | Stacked Dual-Ratio, Dual Interface, Gull Wing Package |
| STQ | Stacked Dual-Ratio, Dual Interface, Through-Hole Package |
| SLQF | Stacked/Low Profile, Dual-Ratio, Dual Interface, Flat Pack Package |
| SLQG | Stacked/Low Profile, Dual-Ratio, Dual Interface, Gull Wing Package |
| SLQT | Stacked/Low Profile, Dual-Ratio, Dual Interface, Through-Hole Package |

- Designed and built to conform to MIL-PRF-21038/27 requirements.
 - **Custom capabilities are available** - See Temperature Range Options
 - Parts can be built and screened to Space NASA EEE-INST-002 requirements.
- ** For use with 3.3VDC Transceivers

Flat Pack

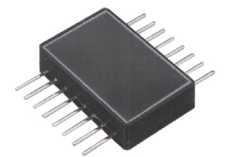

Gull Wing

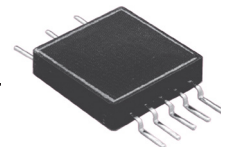

Through-Hole

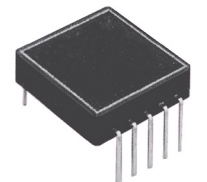

MIL-STD-1553 INTERFACE TRANSFORMERS (continued)

| Interface Transformers — COTS Series | | | | |
|--------------------------------------|-----------------------|----------------------|----------------------|---------------|
| Part * Number | Turns Ratio (±3%) | Impedance (W MIN) | Package L/W/H in. | Data Sheet |
| (X)1553-1 | 1CT:1CT/1CT:707CT | 4,000 | .625/.625/.250 | M233 |
| (X)1553-2 | 1.4CT:1CT/2CT:1CT | 7,200 | .625/.625/.250 | M233 |
| (X)1553-3 | 1.25CT:1CT/1.66CT:1CT | 4,000 | .625/.625/.250 | M233 |
| (X)1553-5 | 1CT:2.12CT/1.5CT:1CT | 4,000 | .625/.625/.250 | M233 |
| (X)1553-45 | 1CT:2.5CT/1CT:1.79CT | 4,000 | .625/.625/.250 | M233 |

- Designed and built to conform to MIL-PRF-21038/27
- To purchase, select desired operating temp. range and add prefix listed below

*Choose 1 of 3 Operating Temperature Ranges

| Part Number Prefix | Operating Temperature |
|--------------------|-----------------------|
| C | 0° to 70°C |
| N | -40° to +85°C |
| TQ | -55° to +125°C |

| Single Interface Transformers — COTS Low Profile Miniature Series | | | | |
|---|----------------------|----------------------|------------------------|---------------|
| Part Number | Turns Ratio (±3%) | Impedance (W MIN) | Package (L/W/H) in. | Data Sheet |
| SMG1553-60 | 1.25CT:1CT | 4,000 | .400/.400/.185 | M112 |
| SMG1553-61 | 1.66CT:1CT | 4,000 | .400/.400/.185 | M112 |
| SMG1553-65 | 1CT:2.5CT | 4,000 | .400/.400/.185 | M112 |
| SMG1553-66 | 1CT:1.79CT | 4,000 | .400/.400/.185 | M112 |
| SMG1553-67 | 1CT:2.7CT | 4,000 | .400/.400/.185 | M112 |
| SMG1553-68 | 1CT:3.75CT | 4,000 | .400/.400/.185 | M112 |

- Designed and built to conform to MIL-PRF-21038/27

| Dual Interface Transformers — COTS Low Profile Miniature Series | | | | |
|---|-----------------------|----------------------|------------------------|---------------|
| Part Number | Turns Ratio (±3%) | Impedance (W MIN) | Package (L/W/H) in. | Data Sheet |
| DKG1553-45 | 1CT:2.50CT/1CT:1.79CT | 4,000 | .675/.400/.185 | M322 |
| DKG1553-70 | 1CT:3.00CT/1CT:2.15CT | 4,000 | .675/.400/.185 | M322 |
| DKG1553-71 | 1CT:3.54CT/1CT:2.70CT | 4,000 | .675/.400/.185 | M222 |
| DKG1553-72 | 1CT:2.65CT/1CT:2.07CT | 4,000 | .675/.400/.185 | M322 |
| DKG1553-75 | 1CT:2.50CT/1CT:1.79CT | 4,000 | .675/.400/.185 | M322 |

- Designed and built to conform to MIL-PRF-21038/27

| QPL Series — Qualified to MIL-PRF-21038/27 | | | | | |
|--|-----------------------------------|-----------------------|----------------------|------------------------|---------------|
| Part ** Number | Military Designation Number | Turns Ratio (±3%) | Impedance (W MIN) | Package L/W/H (in.) | Data Sheet |
| Q(X)1553-20 | M21038/27-05 | 1:1.41 | 3,000 | .500/.350/.250 | M223 |
| Q(X)1553-21 | M21038/27-06 | 1CT:1CT | 3,000 | .500/.350/.250 | M223 |
| Q(X)1553-22 | M21038/27-07 | 1CT:1.41CT | 3,000 | .500/.350/.250 | M223 |
| Q(X)1553-23 | M21038/27-08 | 1CT:1.66CT | 3,000 | .500/.350/.250 | M223 |
| Q(X)1553-24 | M21038/27-09 | 1CT:2CT | 3,000 | .500/.350/.250 | M223 |
| Q(X)1553-25 | M21038/27-28 | 1CT:1.5CT | 3,000 | .500/.350/.250 | M223 |
| Q(X)1553-51 | M21038/27-29 | 1CT:1.79CT | 3,000 | .500/.350/.250 | M223 |
| Q(X)1553-52 | M21038/27-30 | 1CT:2.5CT | 3,000 | .500/.350/.250 | M223 |
| Q(X)1553-1 | M21038/27-01 | 1CT:1CT/1CT:707CT | 4,000 | .625/.625/.250 | M224 |
| Q(X)1553-2 | M21038/27-02 | 1.4CT:1CT/2CT:1CT | 7,200 | .625/.625/.250 | M224 |
| Q(X)1553-3 | M21038/27-03 | 1.25CT:1CT/1.66CT:1CT | 4,000 | .625/.625/.250 | M224 |
| Q(X)1553-5 | M21038/27-10 | 1CT:2.12CT/1CT:1.5CT | 4,000 | .625/.625/.250 | M224 |
| Q(X)1553-45 | M21038/27-26 | 1CT:2.5CT/1CT:1.79CT | 4,000 | .625/.625/.250 | M224 |
| Q(X)1553-81 | M21038/27-21 | 1CT:1CT/1CT:707CT | 4,000 | .625/.625/.275 | M224 |
| Q(X)1553-82 | M21038/27-22 | 1.4CT:1CT/2CT:1CT | 7,200 | .625/.625/.275 | M224 |
| Q(X)1553-83 | M21038/27-23 | 1.25CT:1CT/1.66CT:1CT | 4,000 | .625/.625/.275 | M224 |
| Q(X)1553-84 | M21038/27-24 | 1CT:2.12CT/1CT:1.5CT | 4,000 | .625/.625/.275 | M224 |
| Q(X)1553-85 | M21038/27-25 | 1CT:2.5CT/1CT:1.79CT | 4,000 | .625/.625/.275 | M224 |
| FPQ(X)1553-6 | M21038/27-16 | 1CT:1CT/1CT:707CT | 4,000 | .625/.625/.250 | M225 |
| SMQ(X)1553-6 | M21038/27-11 | 1CT:1CT/1CT:707CT | 4,000 | .625/.625/.250 | M225 |
| FPQ(X)1553-7 | M21038/27-17 | 1.4CT:1CT/2CT:1CT | 7,200 | .625/.625/.250 | M225 |
| SMQ(X)1553-7 | M21038/27-12 | 1.4CT:1CT/2CT:1CT | 7,200 | .625/.625/.250 | M225 |
| FPQ(X)1553-8 | M21038/27-18 | 1.25CT:1CT/1.66CT:1CT | 4,000 | .625/.625/.250 | M225 |
| SMQ(X)1553-8 | M21038/27-13 | 1.25CT:1CT/1.66CT:1CT | 4,000 | .625/.625/.250 | M225 |
| FPQ(X)1553-10 | M21038/27-20 | 1CT:2.12CT/1CT:1.5CT | 4,000 | .625/.625/.250 | M225 |
| SMQ(X)1553-10 | M21038/27-15 | 1CT:2.12CT/1CT:1.5CT | 4,000 | .625/.625/.250 | M225 |
| FPQ(X)1553-45 | M21038/27-31 | 1CT:2.5CT/1CT:1.79CT | 4,000 | .625/.625/.250 | M225 |
| SMQ(X)1553-45 | M21038/27-27 | 1CT:2.5CT/1CT:1.79CT | 4,000 | .625/.625/.250 | M225 |

- Designed and built to conform to MIL-PRF-21038/27
- To purchase, select desired Product Level and choose corresponding Part Number

** Choose 1 of 3 Product Levels

| Part Number Variation | Product Level |
|---|---|
| Q1553-20 <small>(No Variation)</small> | Level M: for general purpose military applications |
| QC1553-20 | Level C: for high reliability commercial/industrial applications |
| QT1553-20 | Level T: for high reliability critical military applications |

- Each Product Level utilizes a different degree of Inspection, Sampling, and Testing. **For specific information, please view the Data Sheets listed in table above.**
- View stock and download literature on the web at <http://www.inrcore.com> - On the Home page, "Search by Part Number"
- To order in Tape & Reel packaging, add the suffix "T" to the part number (i.e. Q1553-20T)

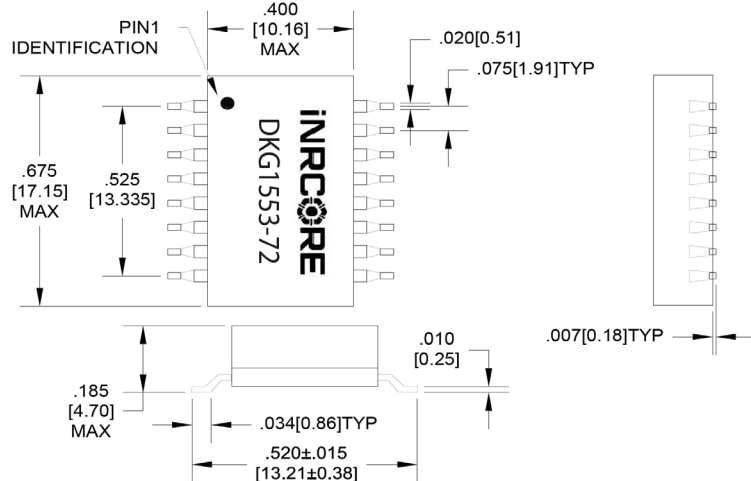

| GENERAL PURPOSE PULSE TRANSFORMERS | | | | | | | |
|------------------------------------|------------------------------|-----------------------------------|-----------------------|---------------|-------------------------------|-----------------------------|-----------|
| TRANSFORMERS | | | | | | | |
| Part Number | Turns Ratio (1,5): (6,2) ±2% | Primary Inductance (1-5) (mH MIN) | DCR (1-5,6-2) (W MAX) | ET (V-us Min) | Insulation Resistance @250Vdc | Leakage Inductance (µH Max) | Datasheet |
| IZUHD | 1CT:1CT | 5.0 | 1.25 | 20 | 10KMohm | 2.25 | M480 |
| IZUHE | 1CT:1CT | 3.0 | 1.25 | 10 | 10KMohm | 2.70 | M481 |

| LOW-SPEED DATA TRANSFORMERS | | | | | | | |
|--------------------------------------|---------------------------|------------------|--------------------------|-----------------|--------------|---------------------|-----------|
| T1/E1/CEPT/ISDN-PRI SMT TRANSFORMERS | | | | | | | |
| Part Number | Turns Ratio Pri: Sec: ±2% | OCL Pri (mH MIN) | C _{ww} (pf MAX) | DCR Pri (W MAX) | Primary Pins | Package L/W/H (in.) | Datasheet |
| X-1707 | 1CT:1CT | 1.0 | 25 | 0.8 | 1-3 | .360/.405/.270 | M487 |
| PL1374 | 1CT:1CT | 1.2 | 35 | 0.8 | 1-3 | .300/.275/.250 | M119 |
| X-1688 | 1CT:1CT | 1.2 | 35 | 0.8 | 1-3 | .300/.275/.275 | M486 |

| LOW-SPEED DATA TRANSFORMERS | | | | | | | |
|-------------------------------|---------------------------|-----------------------------|-----------------------------|-----------------|---------------------------|---------------------|-----------|
| 64kbps ISOLATION TRANSFORMERS | | | | | | | |
| Part Number | Turns Ratio Pri: Sec: ±2% | Primary Inductance (µH MIN) | Leakage Inductance (µH MAX) | DCR Pri (W MAX) | Inter-winding Capacitance | Package L/W/H (in.) | Datasheet |
| X-1703 | 2:1 | 1.0mH | 24 | 3.00 | 36 | .940/.775/.810 | M489 |
| X-1709 | 1:2CT | 20mH | 5.0 | 2.65 | 130 | .448/.335/.400 | M483 |

| HIGH-SPEED DATA TRANSFORMERS | | | | | | | |
|------------------------------|---------------------------|-----------------------------|--------------------------|-----------------|-------------------|---------------------|-----------|
| FIBRE CHANNEL ISOLATION | | | | | | | |
| Part Number | Turns Ratio Pri: Sec: ±2% | Primary Inductance (µH MIN) | C _{ww} (pf MAX) | DCR Pri (W MAX) | Hi-Pot (Vrms MIN) | Package L/W/H (in.) | Datasheet |
| X-1704 | 1:1 | 7.5 | 5.0 | .20 | 2000 | .500/.270/.200 | M482 |
| X-1710 | 1:1 | 15.0 | 5.0 | .20 | 150 | .495/.280/.200 | M485 |

| CAN BUS (COMMON MODE CHOKES) | | | | | | | |
|------------------------------|---------------------------|-----------------------------------|-----------------------------|------------------------|-----------------------|---------------------|-----------|
| 80 VDC- 500Vrms | | | | | | | |
| Part Number | Turns Ratio Pri: Sec: ±2% | Inductance (100kHz) (µH +50%-30%) | Leakage Inductance (µH MAX) | DCR Resatitnce (W MAX) | Current Rating (mADC) | Package L/W/H (in.) | Datasheet |
| X-1711 | 1:1 | 11 | .16 | .12 | 800 | .310/.260/.250 | M488 |
| X-1712 | 1:1 | 25 | .24 | .12 | 800 | .310/.260/.250 | M488 |
| X-1713 | 1:1 | 51 | .22 | .20 | 800 | .310/.260/.250 | M488 |
| X-1714 | 1:1 | 100 | .16 | .24 | 800 | .310/.260/.250 | M488 |
| X-1715 | 1:1 | 471 | .27 | .30 | 700 | .310/.260/.250 | M488 |
| X-1716 | 1:1 | 1000 | .43 | .40 | 700 | .310/.260/.250 | M488 |

- View stock and download literature on the web at <http://www.inrcore.com> - On the Home page, "Search by Part Number"
- INRCORE's standard lead finish is tin/lead (Sn63/Pb37). Parts can be ordered Non-Lead by adding "NL" to the part number (i.e. X-1704NL).
- To order in Tape & Reel packaging, add the suffix "T" to the part number (i.e. X-1709T)

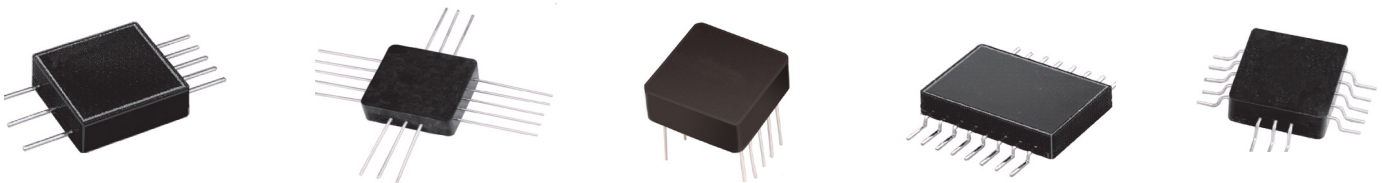

iNRCORE offers custom and catalog power magnetics ruggedized for Military, MIL-PRF-27, MIL-STD-981 and high reliability applications. iNRCORE has a full line of "Off-the-Shelf" inductors for military and aerospace power applications in SLED, SLIC and POGO series packaging. The SLED, SLIC and POGO series use ruggedized high temperature headers suitable for surface mounting to Printed Circuit Board assemblies. Cores are securely bonded to the headers allowing parts to meet MIL-PRF-27 environmental requirements.

iNRCORE offers **Shielded Drum Core Inductors** and **High Frequency Planar Transformers** incorporating ruggedized PCB mounting clips that have superior performance in applications with shock and vibration requirements. iNRCORE also offers catalog **Gate Drive Transformers** with high isolation, miniature **Current Sense Transformers**, and **Common Mode Chokes** with ruggedized construction to meet MIL-PRF-27 Grade 6 requirements.

iNRCORE continues to offer tin/lead termination finishes for Military, Space and Aerospace applications requiring the highest reliability. Parts can also be purchased with tin/lead finishes where RoHS and REACH compliance are required. iNRCORE offers complete design support, qualification test services and global AS9100 manufacturing capabilities.



POWER INDUCTORS & CHOKES

| Toroid Power Inductors - SLED Series | | | | | | |
|--------------------------------------|-------------------------------|------------------------|--------------|--------------------------|---------------------|------------|
| Part Number | @ I _{RATED} (μH) TYP | I _{RATED} (A) | DCR (mW MAX) | Inductance @0ADC (μH)TYP | Package L/W/H (in.) | Data Sheet |
| SLED 20 | | | | | | |
| PL8100 | 1.01 | 3.40 | 11 | 1.1 | .400/.345/.250 | M107 |
| PL8101 | 6.2 | 1.40 | 70 | 7 | .400/.345/.250 | M107 |
| PL8102 | 17.6 | 1.00 | 125 | 22.7 | .400/.345/.250 | M107 |
| SLED 30 | | | | | | |
| PL8110 | 3.8 | 4.80 | 17.3 | 5.2 | .625/.525/.400 | M107 |
| PL8111 | 9.4 | 2.80 | 43.4 | 12.3 | .625/.525/.400 | M107 |
| PL8112 | 29.7 | 1.40 | 166 | 35.3 | .625/.525/.400 | M107 |
| PL8113 | 114 | 0.94 | 380 | 167 | .625/.525/.400 | M107 |
| SLED 40 | | | | | | |
| PL8120 | 2.5 | 8.00 | 8.3 | 3.8 | .725/.575/.410 | M107 |
| PL8121 | 5.1 | 5.40 | 17.7 | 7.5 | .725/.575/.410 | M107 |
| PL8122 | 16.2 | 2.70 | 72 | 21.9 | .725/.575/.410 | M107 |
| PL8123 | 58.1 | 1.30 | 290 | 73 | .725/.575/.410 | M107 |
| PL8124 | 192 | 0.90 | 560 | 292 | .725/.575/.410 | M107 |
| PL8125 | 383 | 0.72 | 862 | 672 | .725/.575/.410 | M107 |
| PL8130 | 4.9 | 7.80 | 12.4 | 7.9 | .725/.575/.410 | M107 |
| PL8131 | 9 | 5.50 | 28 | 14 | .725/.575/.410 | M107 |
| PL8132 | 29.1 | 2.70 | 100 | 40.5 | .725/.575/.410 | M107 |
| PL8133 | 645 | 0.74 | 1250 | 1134 | .725/.575/.410 | M107 |
| PL8150 | 0.81 | 14.30 | 2.5 | 1.25 | .725/.575/.410 | M107 |
| PL8151 | 1.32 | 11.50 | 4.0 | 2.1 | .725/.575/.410 | M107 |
| SLED 50 | | | | | | |
| PL8140 | 9.3 | 7.20 | 18.7 | 16 | .900/.690/.520 | M107 |
| PL8141 | 16.1 | 5.10 | 32.0 | 25.9 | .900/.690/.520 | M107 |
| PL8142 | 50 | 2.60 | 133 | 72.9 | .900/.690/.520 | M107 |
| PL8143 | 1070 | 0.71 | 1700 | 1950 | .900/.690/.520 | M107 |
| PL8160 | 1.68 | 13.90 | 3.6 | 2.8 | .900/.690/.520 | M107 |
| PL8161 | 2.5 | 11.40 | 5.4 | 4.2 | .900/.690/.520 | M107 |
| PL8170 | 3.5 | 12.40 | 6.6 | 6.5 | .900/.690/.520 | M107 |
| PL8171 | 4.7 | 10.40 | 8.3 | 8.4 | .900/.690/.520 | M107 |
| SLED 60 | | | | | | |
| PL8180 | 5.2 | 15.40 | 5.27 | 10.5 | 1.275/1.065/.510 | M107 |
| PL8181 | 9.4 | 10.90 | 10.5 | 17.6 | 1.275/1.065/.510 | M107 |

| SMT Common Mode Chokes: SLIC Series | | | | | |
|-------------------------------------|----------------------|------------------------|--------------|---------------------|------------|
| Part Number | Inductance (mH ±35%) | I _{RATED} (A) | DCR (mW MAX) | Package L/W/H (in.) | Data Sheet |
| SLIC Series | | | | | |
| PL8200 | 0.47 | 14.0 | 8 | 1.220/1.000/500 | M108 |
| PL8201 | 0.63 | 11.6 | 10 | 1.220/1.000/500 | M108 |
| PL8202 | 0.81 | 9.70 | 14 | 1.220/1.000/500 | M108 |
| PL8203 | 0.53 | 7.20 | 15 | 1.110/1.000/395 | M108 |
| PL8204 | 0.59 | 5.60 | 21 | .770/.670/.390 | M108 |
| PL8205 | 0.77 | 4.70 | 40 | .770/.670/.390 | M108 |
| PL8206 | 0.22 | 3.30 | 60 | .770/.670/.390 | M108 |
| PL8207 | 1.32 | 3.30 | 60 | .770/.670/.390 | M108 |
| PL8208 | 1.47 | 2.80 | 80 | .770/.670/.390 | M108 |
| PL8209 | 0.88 | 1.63 | 110 | .500/.500/.215 | M108 |
| PL8210 | 1.17 | 1.22 | 200 | .500/.500/.215 | M108 |
| PL8211 | 10.15 | 1.40 | 210 | .770/.670/.395 | M108 |
| PL8212 | 1.125 | 1.80 | 55 | .500/.519/.200 | M108 |
| PL8213 | 0.80 | 3.00 | 27 | .511/.511/.338 | M108 |
| PL8214 | .383 | 3.3 | 18 | .511/.511/.220 | M108 |
| PL8215 | .536 | 3.8 | 17.1 | .645/.560/.350 | M108 |
| PL8216 | .280 | 4.0 | 13.2 | .511/.511/.220 | M108 |
| PL8217 | .486 | 4.2 | 16.0 | .716/.590/.299 | M108 |
| PL8218 | .130 | 5.0 | 6.75 | .519/.519/.220 | M108 |
| PL8219 | .096 | 6.0 | 4.30 | .519/.519/.200 | M108 |
| PL8220 | .400 | 6.0 | 9.4 | .716/.590/.393 | M108 |
| PL8221 | .061 | 7.0 | 2.9 | .531/.531/.220 | M108 |
| PL8222 | 4.84 | 8.0 | 7.7 | .770/.670/.395 | M108 |
| PL8223 | 1.22 | 9.0 | 9.75 | 1.22/1.00/500 | M108 |
| PL8224 | .215 | 10 | 3.75 | .830/.751/.441 | M108 |
| PL8225 | .095 | 12.5 | 3.0 | .770/.670/.395 | M108 |
| PL8226 | .117 | 14 | 1.9 | .830/.751/.441 | M108 |
| PL8227 | .500 | 16 | 4.25 | 1.22/1.00/500 | M108 |
| PL8228 | .380 | 20 | 4.1 | 1.22/1.00/500 | M108 |

- View stock and download literature on the web at <http://www.incore.com> - On the Home page, "Search by Part Number"
- iNRCORE's standard lead finish is tin/lead (Sn63/Pb37). Parts can be ordered Non-Lead by adding "NL" to the part number (i.e. PL8222NL).
- To order in Tape & Reel packaging, add the suffix "T" to the part number (i.e. PL8225T)



POWER INDUCTORS & CHOKES

SMT Power Inductors: SLIC (HCCI-80) Series

| Part ¹ Number | Inductance @Irated (μH) | Irated (A) | DCR (mW MAX) | Inductance @0ADC (μH) TYP | Package L/W/H (in.) | Data Sheet |
|-----------------------------|----------------------------|---------------|-----------------|------------------------------|------------------------|---------------|
| SLIC (HCCI) | | | | | | |
| PL8300 ^P | 4.52 | 19 | 4.8 | 9.5 | 1.220/1.000/500 | M109 |
| PL8300 ^S | 18.1 | 9.5 | 19.3 | 38.0 | 1.220/1.000/500 | M109 |
| PL8301 ^P | 3.2 | 24 | 3.5 | 7.2 | 1.220/1.000/500 | M109 |
| PL8301 ^S | 12.8 | 12 | 13.8 | 7.2 | 1.220/1.000/500 | M109 |
| PL8302 ^P | 2.45 | 27 | 2.5 | 5.1 | 1.220/1.000/500 | M109 |
| PL8302 ^S | 9.8 | 13.5 | 10.1 | 20.4 | 1.220/1.000/500 | M109 |
| PL8303 ^P | 1.6 | 34 | 1.6 | 3.5 | 1.220/1.000/500 | M109 |
| PL8303 ^S | 6.4 | 17 | 6.4 | 13.8 | 1.220/1.000/500 | M109 |
| PL8304 ^P | 1.1 | 38 | 1.3 | 2.1 | 1.220/1.000/500 | M109 |
| PL8304 ^S | 18.1 | 9.5 | 19.3 | 38.0 | 1.220/1.000/500 | M109 |

1. Connection: P = Parallel, S = Series

SMT Power Inductors: Toroid, POGO Series

| Part ¹ Number | Inductance @Irated (μH) | Irated (A) | DCR (mW MAX) | Inductance @0ADC (μH) TYP | Package L/W/H (in.) | Data Sheet |
|-----------------------------|----------------------------|---------------|-----------------|------------------------------|------------------------|---------------|
| POGO 40 | | | | | | |
| PL8400 ^S | 43.6 | 1.1 | 309 | 247.2 | .725/.575/.310 | M111 |
| POGO 50 | | | | | | |
| PL8401 ^S | 21.9 | 2.7 | 90.5 | 72.4 | .910/.700/.400 | M111 |
| PL8402 ^S | 4.025 | 6.4 | 23.0 | 18.4 | .910/.700/.400 | M111 |
| PL8403 ^P | 0.53 | 23.8 | 3.0 | 1.0 | .910/.700/.400 | M111 |
| PL8404 ^P | 1.1 | 21 | 2.5 | 1.7 | .910/.700/.400 | M111 |
| POGO 60 | | | | | | |
| PL8405 ^P | 2.1 | 22.4 | 3.4 | 2.5 | 1.280/1.070/.400 | M111 |

1. Connection: P = Parallel, S = Series



SMT Power Inductors: Toroid, SLED Series (contd.)

| Part Number | Inductance @Irated (μH) | Irated (A) | DCR (mW MAX) | Inductance @0ADC (μH) TYP | Package L/W/H (in.) | Data Sheet |
|----------------|----------------------------|---------------|-----------------|------------------------------|------------------------|---------------|
| SLED 25 | | | | | | |
| PL8500 | 9.4 | 3.8 | 32 | 10.4 | .625/.525/.310 | M113 |
| PL8501 | 13.3 | 3.2 | 46 | 14.6 | .625/.525/.310 | M113 |
| PL8502 | 23 | 2.4 | 74 | 25 | .625/.525/.310 | M113 |
| PL8503 | 50 | 1.6 | 135 | 56 | .625/.525/.310 | M113 |
| PL8504 | 75 | 1.3 | 220 | 83 | .625/.525/.310 | M113 |
| PL8505 | 90 | 1.2 | 285 | 100 | .625/.525/.310 | M113 |
| PL8506 | 137 | 1 | 425 | 152 | .625/.525/.310 | M113 |
| PL8507 | 200 | .82 | 673 | 220 | .625/.525/.310 | M113 |
| PL8508 | 305 | .66 | 972 | 331 | .625/.525/.310 | M113 |
| PL8509 | 439 | .56 | 1520 | 472 | .625/.525/.310 | M113 |

SMT Power Inductors: Toroid, POGO Series (contd.)

| Part ¹ Number | Inductance @Irated (μH) | Irated (A) | DCR (mW MAX) | Inductance @0ADC (μH) TYP | Package L/W/H (in.) | Data Sheet |
|-----------------------------|----------------------------|---------------|-----------------|------------------------------|------------------------|---------------|
| POGO 25 | | | | | | |
| PL8600 ^P | 2.0 | 8.30 | 8.0 | 2.2 | .625/.525/.310 | M114 |
| PL8600 ^S | 7.0 | 4.16 | 16.0 | 8.75 | .625/.525/.310 | M114 |
| PL8601 ^P | 2.4 | 7.20 | 10.9 | 2.6 | .625/.525/.310 | M114 |
| PL8601 ^S | 8.4 | 3.78 | 21.8 | 10.4 | .625/.525/.310 | M114 |
| PL8602 ^P | 5.0 | 5.20 | 19.0 | 5.5 | .625/.525/.310 | M114 |
| PL8602 ^S | 17.9 | 2.6 | 38.0 | 22.45 | .625/.525/.310 | M114 |
| PL8603 ^P | 9.3 | 3.80 | 30.0 | 10.4 | .625/.525/.310 | M114 |
| PL8603 ^S | 33.8 | 1.89 | 60 | 41.7 | .625/.525/.310 | M114 |
| PL8604 ^P | 14.1 | 3.10 | 45.5 | 15.7 | .625/.525/.310 | M114 |
| PL8604 ^S | 50.9 | 1.54 | 91 | 62.8 | .625/.525/.310 | M114 |
| PL8605 ^P | 19.8 | 2.6 | 66.5 | 22.1 | .625/.525/.310 | M114 |
| PL8605 ^S | 29.3 | 2.20 | 101 | 32.8 | .625/.525/.310 | M114 |
| PL8606 ^P | 29.3 | 2.20 | 101 | 32.8 | .625/.525/.310 | M114 |
| PL8606 ^S | 106.1 | 1.07 | 202 | 131.0 | .625/.525/.310 | M114 |
| PL8607 ^P | 42.6 | 1.80 | 151 | 47.6 | .625/.525/.310 | M114 |

1. Connection: P = Parallel, S = Series

- View stock and download literature on the web at <http://www.inrcore.com> - On the Home page, "Search by Part Number"
- To order in Tape & Reel packaging, add the suffix "T" to the part number (i.e. PL8400T)
- iNRCORE's standard lead finish is tin/lead (Sn63/Pb37). Parts can be ordered Non-Lead by adding "NL" to the part number (i.e. PL8400NL).
- The rated current as listed is either the saturation current or the heating current

SLED 25

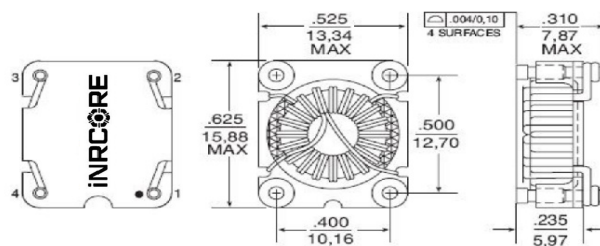
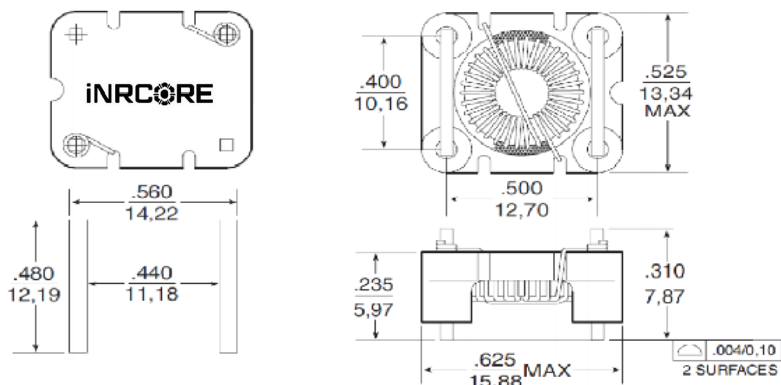

POGO 25



POWER INDUCTORS & CHOKES

| SMT Power Inductors: Toroid, POGO Series (contd.) | | | | | | |
|---|--|------------------------|--------------|---------------------------|---------------------|------------|
| Part ¹ Number | Inductance @ I _{RATED} (μH) MIN | I _{RATED} (A) | DCR (mW MAX) | Inductance @0ADC (μH) TYP | Package L/W/H (in.) | Data Sheet |
| POGO 25 | | | | | | |
| PL8607 ^S | 154.2 | 0.89 | 302 | 190.3 | .625/.525/.310 | M114 |
| PL8608 ^P | 61.3 | 1.50 | 222 | 67.5 | .625/.525/.310 | M114 |
| PL8608 ^S | 218.9 | 0.74 | 444 | 270.2 | .625/.525/.310 | M114 |
| PL8609 ^P | 84.2 | 1.30 | 318 | 91.0 | .625/.525/.310 | M114 |
| PL8609 ^S | 295.0 | 0.64 | 636 | 364.0 | .625/.525/.310 | M114 |
| POGO 40 | | | | | | |
| PL8700 ^P | 1.5 | 14.40 | 4.41 | 2.2 | .725/.575/.380 | M115 |
| PL8701 ^P | 2.4 | 9.40 | 6.54 | 3.5 | .725/.575/.380 | M115 |
| PL8702 ^P | 4.2 | 8.10 | 10.47 | 5.9 | .725/.575/.380 | M115 |
| PL8703 ^P | 5.8 | 6.80 | 14.94 | 7.9 | .725/.575/.380 | M115 |
| PL8704 ^P | 7.6 | 5.70 | 20.99 | 10.1 | .725/.575/.380 | M115 |
| PL8705 ^P | 12.1 | 5.20 | 23.24 | 18.5 | .725/.575/.380 | M115 |
| PL8706 ^P | 18.0 | 4.20 | 38.15 | 27.4 | .725/.575/.380 | M115 |
| PL8707 ^P | 27.0 | 3.30 | 53.21 | 40.5 | .725/.575/.380 | M115 |
| PL8708 ^P | 34.8 | 2.30 | 73.89 | 50.5 | .725/.575/.380 | M115 |
| PL8700 ^S | 6.1 | 7.20 | 17.60 | 9.0 | .725/.575/.380 | M115 |
| PL8701 ^S | 9.7 | 5.60 | 26.20 | 14.0 | .725/.575/.380 | M115 |
| PL8702 ^S | 17.0 | 4.10 | 41.90 | 23.7 | .725/.575/.380 | M115 |
| PL8703 ^S | 23.1 | 3.40 | 59.70 | 31.5 | .725/.575/.380 | M115 |
| PL8704 ^S | 30.6 | 2.85 | 84.00 | 40.5 | .725/.575/.380 | M115 |
| PL8705 ^S | 48.5 | 2.70 | 93.00 | 74.1 | .725/.575/.380 | M115 |
| PL8706 ^S | 72.0 | 2.20 | 152.60 | 109.8 | .725/.575/.380 | M115 |
| PL8707 ^S | 108.0 | 1.77 | 212.80 | 161.8 | .725/.575/.380 | M115 |
| PL8708 ^S | 139.1 | 1.50 | 295.60 | 202.2 | .725/.575/.380 | M115 |

| SMT Power Inductors: Shielded Drum Core | | | | | | | |
|---|---|------------------------|--------------|--|--------------------------|---------------------|------------|
| Part Number | Inductance @I _{RATED} (μH TYP) | I _{RATED} (A) | DCR (mW MAX) | Inductance ² @0ADC (μH) TYP | Saturation Current @25°C | Package L/W/H (in.) | Data Sheet |
| PL8901 | 0.80 | 11 | 4.0 | 1.0 ² | 14 | .413/.413/.280 | M117 |
| PL8902 | 1.20 | 10 | 6.0 | 1.5 ² | 13 | .413/.413/.280 | M117 |
| PL8903 | 2.1 | 9.0 | 7.3 | 2.7 ² | 11 | .413/.413/.280 | M117 |
| PL8904 | 2.9 | 8.0 | 8.5 | 3.7 ² | 9.2 | .413/.413/.280 | M117 |
| PL8905 | 3.7 | 7.3 | 9.5 | 4.7 ² | 8.2 | .413/.413/.280 | M117 |
| PL8906 | 4.8 | 6.0 | 16.5 | 6.0 ² | 6.9 | .413/.413/.280 | M117 |
| PL8907 | 6 | 5.5 | 18.5 | 7.6 ² | 6.2 | .413/.413/.280 | M117 |
| PL8908 | 8 | 5.0 | 21.8 | 10 | 5.5 | .413/.413/.280 | M117 |
| PL8909 | 9.6 | 4.5 | 29.0 | 12 | 5.1 | .413/.413/.280 | M117 |
| PL8910 | 12 | 4.1 | 35.4 | 15 | 4.4 | .413/.413/.280 | M117 |
| PL8911 | 14.4 | 4.0 | 37.0 | 18 | 4.3 | .413/.413/.280 | M117 |
| PL8912 | 17.6 | 3.8 | 42.0 | 22 | 3.8 | .413/.413/.280 | M117 |
| PL8913 | 21.6 | 3.4 | 45.9 | 27 | 3.4 | .413/.413/.280 | M117 |
| PL8914 | 26.4 | 3.0 | 64.8 | 33 | 3.0 | .413/.413/.280 | M117 |
| PL8915 | 31.2 | 2.7 | 81.5 | 39 | 2.8 | .413/.413/.280 | M117 |
| PL8916 | 37.6 | 2.6 | 89.0 | 47 | 2.6 | .413/.413/.280 | M117 |
| PL8917 | 54.4 | 2.1 | 135.0 | 68 | 2.1 | .413/.413/.280 | M117 |
| PL9101 | 0.96 | 10.5 | 4.5 | 1.0 ² | 12.7 | .413/.413/.248 | M121 |
| PL9102 | 1.52 | 9.5 | 5.5 | 1.8 ² | 10.1 | .413/.413/.248 | M121 |
| PL9103 | 2.34 | 7.8 | 7.8 | 2.7 ² | 8.4 | .413/.413/.248 | M121 |
| PL9104 | 3.27 | 6.7 | 11.0 | 3.9 ² | 7.2 | .413/.413/.248 | M121 |
| PL9105 | 4.39 | 5.6 | 15.6 | 5.1 ² | 6.3 | .413/.413/.248 | M121 |
| PL9106 | 5.54 | 5.2 | 18.0 | 6.8 ² | 5.6 | .413/.413/.248 | M121 |
| PL9107 | 6.73 | 5.0 | 20.0 | 8.2 ² | 5.1 | .413/.413/.248 | M121 |
| PL9108 | 8.19 | 4.6 | 22 | 10 | 4.6 | .413/.413/.248 | M121 |
| PL9109 | 9.9 | 4.2 | 27 | 12 | 4.2 | .413/.413/.248 | M121 |
| PL9110 | 13.4 | 3.6 | 30 | 15 | 3.6 | .413/.413/.248 | M121 |
| PL9111 | 15.4 | 3.4 | 40 | 18 | 3.4 | .413/.413/.248 | M121 |
| PL9112 | 17.6 | 3.2 | 45 | 22 | 3.2 | .413/.413/.248 | M121 |
| PL9113 | 22.5 | 2.8 | 62 | 27 | 2.8 | .413/.413/.248 | M121 |
| PL9114 | 28.5 | 2.5 | 70 | 33 | 2.5 | .413/.413/.248 | M121 |
| PL9115 | 31.4 | 2.4 | 75 | 39 | 2.4 | .413/.413/.248 | M121 |
| PL9116 | 38.4 | 2.2 | 100 | 47 | 2.2 | .413/.413/.248 | M121 |
| PL9117 | 48.3 | 1.9 | 110 | 56 | 1.9 | .413/.413/.248 | M121 |
| PL9118 | 55.9 | 1.8 | 120 | 68.0 | 1.8 | .413/.413/.248 | M121 |
| PL9119 | 67.6 | 1.7 | 178 | 82.0 | 1.7 | .413/.413/.248 | M121 |
| PL9120 | 86.1 | 1.4 | 230 | 100.0 | 1.4 | .413/.413/.248 | M121 |
| PL9121 | 103 | 1.3 | 253 | 120.0 | 1.3 | .413/.413/.248 | M121 |
| PL9122 | 121 | 1.2 | 280 | 150.0 | 1.2 | .413/.413/.248 | M121 |
| PL9123 | 149 | 1.1 | 310 | 180.0 | 1.1 | .413/.413/.248 | M121 |
| PL9124 | 186 | 1.0 | 400 | 220.0 | 1.0 | .413/.413/.248 | M121 |
| PL9125 | 224 | 0.91 | 460 | 270 | 0.91 | .413/.413/.248 | M121 |
| PL9126 | 279 | 0.82 | 690 | 330 | 0.82 | .413/.413/.248 | M121 |
| PL9127 | 335 | 0.72 | 760 | 390 | 0.72 | .413/.413/.248 | M121 |
| PL9128 | 398 | 0.68 | 850 | 470 | 0.68 | .413/.413/.248 | M121 |
| PL9129 | 464 | 0.63 | 1060 | 560 | 0.63 | .413/.413/.248 | M121 |
| PL9130 | 563 | 0.57 | 1200 | 680 | 0.57 | .413/.413/.248 | M121 |
| PL9131 | 681 | 0.52 | 1550 | 820 | 0.52 | .413/.413/.248 | M121 |

| SMT Common Mode Inductors: Toroid, POGO Series | | | | | | | |
|--|----------------------|------------------------|--------------|-----------|------------------|---------------------|------------|
| Part Number | Inductance (mH ±30%) | I _{rated} (A) | DCR (mW MAX) | SRF (MHz) | Impedance Curve* | Package L/W/H (in.) | Data Sheet |
| POGO 40 | | | | | | | |
| PL8801 | 1.5 | 1.50 | 60 | 2 | 2 | .725/.575/.380 | M116 |
| PL8803 | 10.0 | 1.00 | 450 | 0.5 | 4 | .725/.575/.380 | M116 |
| PL8804 | 22.0 | 0.50 | 850 | 0.3 | 5 | .725/.575/.380 | M116 |
| POGO 50 | | | | | | | |
| PL8800 | 1.0 | 3.60 | 50 | 4 | 1 | .910/.700/.510 | M116 |
| PL8802 | 3.0 | 2.50 | 80 | 2.2 | 3 | .910/.700/.510 | M116 |

* Impedance Curves

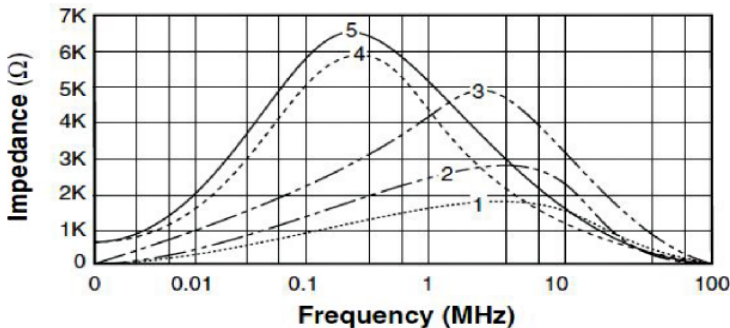

1. Connection: P = Parallel, S = Series
2. Inductance at 0ADC tolerance is ± 30% The tolerance is ± 20% on all other parts.

- View stock and download literature on the web at <http://www.inrcore.com> - On the Home page, "Search by Part Number"
- To order in Tape & Reel packaging, add the suffix "T" to the part number (i.e. PL9123T)
- INRCORE's standard lead finish is tin/lead (Sn63/Pb37). Parts can be ordered Non-Lead by adding "NL" to the part number (i.e. PL9123NL).

continued on the next page

POWER INDUCTORS (continued)

SMT Power Inductors: Shielded Drum Core (continued)

| Part Number | Inductance @Irated (μH TYP) | Irated ¹ (A) | DCR (mW MAX) | Inductance @0ADC (μH) TYP | Saturation Current @25°C | Package L/W/H (in.) | Data Sheet | Part Number | Inductance @Irated (μH TYP) | Irated ¹ (A) | DCR (mW MAX) | Inductance @0ADC (μH) TYP | Saturation Current @25°C | Package L/W/H (in.) | Data Sheet |
|-------------|-----------------------------|-------------------------|--------------|---------------------------|--------------------------|---------------------|------------|-------------|-----------------------------|-------------------------|--------------|---------------------------|--------------------------|---------------------|------------|
| PL9201 | 0.95 | 8.7 | 5.7 | 1.0 | 11 | .413/.413/.201 | M122 | PL9401 | 0.67 | 7.00 | 4.4 | 0.68 | 7.00 | .410/.410/.132 | M123 |
| PL9202 | 1.55 | 7.4 | 7.9 | 1.6 | 8.8 | .413/.413/.201 | M122 | PL9402 | 1.3 | 6.10 | 6.4 | 1.5 | 6.10 | .410/.410/.132 | M123 |
| PL9203 | 2.32 | 6.6 | 10.0 | 2.7 | 7.3 | .413/.413/.201 | M122 | PL9403 | 2.1 | 5.70 | 10.4 | 2.2 | 5.70 | .410/.410/.132 | M123 |
| PL9204 | 3.24 | 5.5 | 4.5 | 3.6 | 6.3 | .413/.201/.201 | M122 | PL9404 | 3.1 | 4.80 | 15.6 | 3.3 | 4.80 | .410/.410/.132 | M123 |
| PL9205 | 4.26 | 5.1 | 16.5 | 4.5 | 5.5 | .413/.413/.201 | M122 | PL9405 | 4.5 | 4.10 | 21.2 | 4.7 | 4.10 | .410/.410/.132 | M123 |
| PL9206 | 5.64 | 4.4 | 22 | 6.0 | 4.9 | .413/.413/.201 | M122 | PL9406 | 5.8 | 3.60 | 25.2 | 6.2 | 3.60 | .410/.410/.132 | M123 |
| PL9207 | 7.17 | 4.2 | 25 | 7.6 | 4.4 | .413/.413/.201 | M122 | PL9407 | 7.0 | 3.30 | 27.8 | 6.8 | 3.30 | .410/.410/.132 | M123 |
| PL9208 | 9.3 | 3.6 | 35 | 10 | 4.0 | .413/.413/.201 | M122 | PL9408 | 9.4 | 3.00 | 39.5 | 8.2 | 3.00 | .410/.410/.132 | M123 |
| PL9209 | 10.8 | 3.3 | 37 | 12 | 3.7 | .413/.413/.201 | M122 | PL9409 | 11 | 2.70 | 42.9 | 10 | 2.70 | .410/.410/.132 | M123 |
| PL9210 | 13.4 | 3.0 | 47 | 15 | 3.4 | .413/.413/.201 | M122 | PL9410 | 12 | 2.40 | 50.0 | 12 | 2.40 | .410/.410/.132 | M123 |
| PL9211 | 17.5 | 2.7 | 58 | 18 | 2.9 | .413/.413/.201 | M122 | PL9411 | 15 | 2.25 | 65.2 | 15 | 2.25 | .410/.410/.132 | M123 |
| PL9212 | 19.4 | 2.6 | 67 | 22 | 2.8 | .413/.413/.201 | M122 | PL9412 | 24 | 1.85 | 86.1 | 22 | 1.85 | .410/.410/.132 | M123 |
| PL9213 | 24.2 | 2.2 | 79 | 27 | 2.4 | .413/.413/.201 | M122 | PL9413 | 35 | 1.40 | 126 | 33 | 1.40 | .410/.410/.132 | M123 |
| PL9214 | 30.6 | 2.1 | 94 | 33 | 2.2 | .413/.413/.201 | M122 | PL9414 | 48 | 1.25 | 188 | 47 | 1.25 | .410/.410/.132 | M123 |
| PL9215 | 38.5 | 1.8 | 126 | 39 | 2.0 | .413/.413/.201 | M122 | PL9415 | 55 | 1.15 | 208 | 56 | 1.15 | .410/.410/.132 | M123 |
| PL9216 | 46.1 | 1.7 | 140 | 47 | 1.8 | .413/.413/.201 | M122 | PL9416 | 64 | 1.05 | 279 | 68 | 1.05 | .410/.410/.132 | M123 |
| PL9217 | 53.2 | 1.6 | 157 | 56 | 1.7 | .413/.413/.201 | M122 | PL9417 | 88 | 0.94 | 317 | 82 | 0.94 | .410/.410/.132 | M123 |
| PL9218 | 63.1 | 1.45 | 202 | 68.0 | 1.6 | .413/.413/.201 | M122 | PL9418 | 106 | 0.88 | 358 | 100 | 0.88 | .410/.410/.132 | M123 |
| PL9219 | 76.6 | 1.36 | 232 | 82.0 | 1.4 | .413/.413/.201 | M122 | PL9419 | 129 | 0.80 | 478 | 120 | 0.80 | .410/.410/.132 | M123 |
| PL9220 | 88 | 1.29 | 270 | 100.0 | 1.3 | .413/.413/.201 | M122 | PL9420 | 157 | 0.70 | 545 | 150 | 0.70 | .410/.410/.132 | M123 |
| PL9221 | 112 | 1.07 | 316 | 120.0 | 1.2 | .413/.413/.201 | M122 | PL9421 | 238 | 0.58 | 837.0 | 220 | 0.58 | .410/.410/.132 | M123 |
| PL9222 | 135 | 1.02 | 456 | 150.0 | 1.05 | .413/.413/.201 | M122 | PL9422 | 325 | 0.45 | 1199 | 330 | 0.45 | .410/.410/.132 | M123 |
| PL9223 | 132 | 0.87 | 497 | 180.0 | 0.96 | .413/.413/.201 | M122 | PL9501 | 2.15 | 2.60 | 17.6 | 2.5 | 2.6 | .256/.256/.122 | M124 |
| PL9224 | 198 | 0.82 | 681 | 220.0 | 0.86 | .413/.413/.201 | M122 | PL9502 | 2.58 | 2.30 | 20.3 | 3.3 | 2.3 | .256/.256/.122 | M124 |
| PL9225 | 237 | 0.78 | 775 | 270 | 0.79 | .413/.413/.201 | M122 | PL9503 | 3.43 | 2.10 | 27.0 | 4 | 2.1 | .256/.256/.122 | M124 |
| PL9226 | 296 | 0.66 | 955 | 330 | 0.71 | .413/.413/.201 | M122 | PL9504 | 4.63 | 1.85 | 31.1 | 5 | 1.85 | .256/.256/.122 | M124 |
| PL9227 | 355 | 0.58 | 1087 | 390 | 0.66 | .413/.413/.201 | M122 | PL9505 | 5.22 | 1.70 | 41.9 | 6 | 1.7 | .256/.256/.122 | M124 |
| PL9228 | 445 | 0.54 | 1403 | 470 | 0.59 | .413/.413/.201 | M122 | PL9506 | 6.57 | 1.50 | 49.9 | 8 | 1.5 | .256/.256/.122 | M124 |
| PL9229 | 495 | 0.53 | 1623 | 560 | 0.54 | .413/.413/.201 | M122 | PL9507 | 8.65 | 1.30 | 54.0 | 10 | 1.3 | .256/.256/.122 | M124 |
| PL9230 | 610 | 0.49 | 1824 | 680 | 0.49 | .413/.413/.201 | M122 | PL9508 | 9.78 | 1.20 | 72.0 | 12 | 1.2 | .256/.256/.122 | M124 |
| PL9231 | 702 | 0.43 | 2355 | 820 | 0.45 | .413/.413/.201 | M122 | PL9509 | 12.13 | 1.10 | 82.0 | 15 | 1.1 | .256/.256/.122 | M124 |
| PL9232 | 890 | 0.40 | 2850 | 1000 | 0.41 | .413/.413/.201 | M122 | PL9510 | 15.23 | 1.05 | 102.0 | 18 | 1.05 | .256/.256/.122 | M124 |
| PL9301 | 0.62 | 7.60 | 5.5 | 0.68 | 10 | .410/.410/.157 | M120 | PL9511 | 18.7 | 0.95 | 119.0 | 22 | 0.95 | .256/.256/.122 | M124 |
| PL9302 | 1.2 | 7.10 | 7.3 | 1.3 | 8 | .410/.410/.157 | M120 | PL9512 | 21.54 | 0.85 | 146.0 | 27 | 0.85 | .256/.256/.122 | M124 |
| PL9303 | 1.9 | 5.80 | 10.9 | 2.2 | 6.15 | .410/.410/.157 | M120 | PL9513 | 27.71 | 0.76 | 183.0 | 33 | 0.76 | .256/.256/.122 | M124 |
| PL9304 | 2.8 | 5.20 | 13.3 | 3.3 | 5.8 | .410/.410/.157 | M120 | PL9514 | 33.57 | 0.68 | 210.0 | 39 | 0.68 | .256/.256/.122 | M124 |
| PL9305 | 4.0 | 4.70 | 19.6 | 4.7 | 5.4 | .410/.410/.157 | M120 | PL9515 | 40.15 | 0.60 | 230.0 | 47 | 0.6 | .256/.256/.122 | M124 |
| PL9306 | 5.4 | 3.70 | 27.0 | 6.0 | 4.5 | .410/.410/.157 | M120 | PL9516 | 49.68 | 0.55 | 305.0 | 56 | 0.55 | .256/.256/.122 | M124 |
| PL9307 | 6.9 | 3.50 | 30.8 | 7.6 | 4 | .410/.410/.157 | M120 | PL9517 | 60.66 | 0.48 | 351.0 | 68 | 0.48 | .256/.256/.122 | M124 |
| PL9308 | 8.0 | 3.40 | 33.2 | 10 | 3.8 | .410/.410/.157 | M120 | PL9518 | 74.71 | 0.45 | 419.0 | 82 | 0.45 | .256/.256/.122 | M124 |
| PL9309 | 11 | 3.00 | 45.2 | 12 | 3.4 | .410/.410/.157 | M120 | PL9519 | 85.39 | 0.40 | 520.0 | 100 | 0.4 | .256/.256/.122 | M124 |
| PL9310 | 12 | 2.80 | 49.4 | 15 | 3.1 | .410/.410/.157 | M120 | | | | | | | | |
| PL9311 | 19 | 2.30 | 77 | 22 | 2.8 | .410/.410/.157 | M120 | | | | | | | | |
| PL9312 | 25 | 2.10 | 89 | 27 | 2.3 | .410/.410/.157 | M120 | | | | | | | | |
| PL9313 | 38 | 1.65 | 142 | 47 | 2.1 | .410/.410/.157 | M120 | | | | | | | | |
| PL9314 | 55 | 1.32 | 212.0 | 68 | 1.5 | .410/.410/.157 | M120 | | | | | | | | |
| PL9315 | 83 | 1.10 | 328 | 100 | 1.35 | .410/.410/.157 | M120 | | | | | | | | |
| PL9316 | 123 | 0.88 | 500 | 150 | 1.15 | .410/.410/.157 | M120 | | | | | | | | |
| PL9317 | 178 | 0.73 | 739 | 220 | 0.92 | .410/.410/.157 | M120 | | | | | | | | |
| PL9318 | 278 | 0.60 | 1133 | 330 | 0.7 | .410/.410/.157 | M120 | | | | | | | | |

- The rated current as listed is either the saturation current or the heating current depending on which value is lower.
- View stock and download literature on the web at <http://www.incore.com> - On the Home page, "Search by Part Number"
 - To order in Tape & Reel packaging, add the suffix "T" to the part number (i.e. PL9515T)
 - iNRCORE's standard lead finish is tin/lead (Sn63/Pb37). Parts can be ordered RoHS compliant by adding the suffix "NL" to the part number (i.e. PL9515NL).

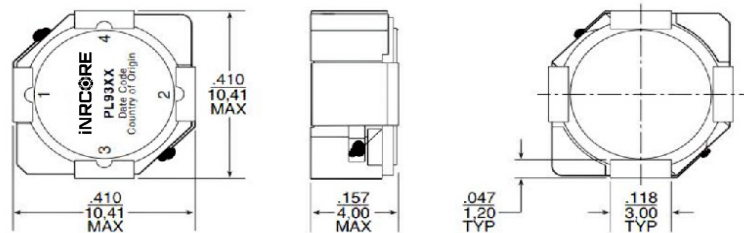

PLANARS POWER INDUCTORS

Electrical Specification @25°C - Operating Temperature -40°C to +130°C

| Part Number | Inductance @Irated (μH ± 15%) | Irated ¹ (ADC) | DCR (mW) | | Inductance @0ADC (μH ± 15%) | Saturation Current (ADC) | | Heating Current (A) | Data Sheet | |
|---------------------------------|-------------------------------|---------------------------|----------|------|-----------------------------|--------------------------|-------|---------------------|------------|--|
| | | | TYP | MAX | | 25°C | 100°C | | | |
| 2-Turn (Low Loss Series) | | | | | | | | | | |
| PL10100 | 0.45 | 73 | 0.38 | 0.48 | 0.45 | 95 | 80 | 73 | M194 | |
| PL10101 | 0.63 | 54 | 0.38 | 0.48 | 0.65 | 63 | 53 | 73 | M194 | |
| PL10102 | 0.85 | 39 | 0.38 | 0.48 | 0.91 | 46 | 37 | 73 | M194 | |
| PL10103 | 1.05 | 30 | 0.38 | 0.48 | 1.10 | 35 | 30 | 73 | M194 | |
| PL10104 | 1.25 | 25 | 0.38 | 0.48 | 1.30 | 29 | 26 | 73 | M194 | |
| PL10105 | 1.45 | 21 | 0.38 | 0.48 | 1.50 | 24 | 22 | 73 | M194 | |
| 2-Turn Series | | | | | | | | | | |
| PL10106 | 0.45 | 52 | 0.78 | 0.98 | 0.45 | 95 | 80 | 52 | M194 | |
| PL10107 | 0.63 | 52 | 0.78 | 0.98 | 0.65 | 63 | 53 | 52 | M194 | |
| PL10108 | 0.85 | 39 | 0.78 | 0.98 | 0.91 | 46 | 37 | 52 | M194 | |
| PL10109 | 1.05 | 30 | 0.78 | 0.98 | 1.10 | 35 | 30 | 52 | M194 | |
| PL10110 | 1.25 | 25 | 0.78 | 0.98 | 1.30 | 29 | 26 | 52 | M194 | |
| PL10111 | 1.45 | 21 | 0.78 | 0.98 | 1.50 | 24 | 22 | 52 | M194 | |
| 3-Turn Series | | | | | | | | | | |
| PL10112 | 0.95 | 42 | 1.15 | 1.43 | 1.00 | 68 | 54 | 42 | M194 | |
| PL10113 | 1.40 | 36 | 1.15 | 1.43 | 1.50 | 43 | 35 | 42 | M194 | |
| PL10114 | 1.90 | 25 | 1.15 | 1.43 | 2.00 | 29 | 25 | 42 | M194 | |
| PL10115 | 2.40 | 20 | 1.15 | 1.43 | 2.50 | 23 | 21 | 42 | M194 | |
| PL10116 | 2.80 | 15 | 1.15 | 1.43 | 3.00 | 18 | 16 | 42 | M194 | |
| PL10117 | 3.40 | 12 | 1.15 | 1.43 | 3.50 | 15 | 13 | 42 | M194 | |
| 4-Turn Series | | | | | | | | | | |
| PL10118 | 1.60 | 37 | 1.44 | 1.80 | 1.60 | 55 | 43 | 37 | M194 | |
| PL10119 | 2.40 | 30 | 1.44 | 1.80 | 2.42 | 35 | 27 | 37 | M194 | |
| PL10120 | 3.30 | 17 | 1.44 | 1.80 | 3.60 | 20 | 18 | 37 | M194 | |
| PL10121 | 4.00 | 14 | 1.44 | 1.80 | 4.40 | 16 | 15 | 37 | M194 | |
| PL10122 | 4.90 | 11 | 1.44 | 1.80 | 5.34 | 13 | 12 | 37 | M194 | |
| PL10123 | 5.80 | 9 | 1.44 | 1.80 | 6.20 | 11 | 10 | 37 | M194 | |

- View stock and download literature on the web at <http://www.inrcore.com> - On the Home page, "Search by Part Number"
- To order in Tape & Reel packaging, add the suffix "T" to the part number (i.e. PL10210T)
- INRCORE's standard lead finish is tin/lead (Sn63/Pb37). Parts can be ordered RoHS compliant by adding the suffix "NL" to the part number (i.e. PL10111NL).

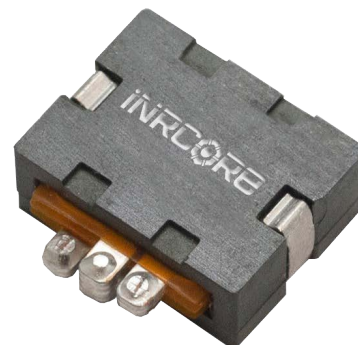
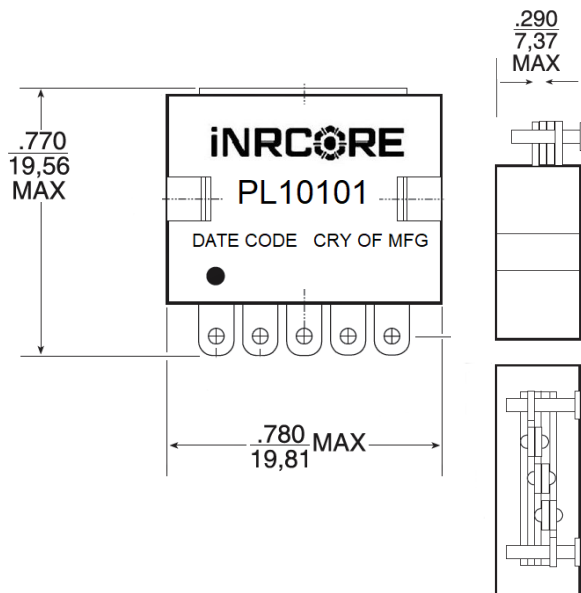

HIGH FREQUENCY PLANAR TRANSFORMERS

Electrical Specification @25°C - Power Rating up to 250W

| Part Number | Turns Ratio | | Primary Inductance (µH MIN) | Leakage Inductance (µH MIN) | DCR (mΩ MAX) | | | Data Sheet |
|-------------|---------------------|-------------|-----------------------------|-----------------------------|--------------|-----------|-------------|------------|
| | Primary | Secondary | | | Primary A | Primary B | Secondary | |
| PL10201 | 4T & 4T | 1T:1T:1T:1T | 216 | 0.3 | 13 | 13 | 4.5 | M343 |
| PL10203 | 5T & 5T | 1T:1T:1T:1T | 340 | 0.3 | 15 | 15 | 4.5 | M343 |
| PL10205 | 6T & 6T | 1T:1T:1T:1T | 480 | 0.3 | 21 | 21 | 4.5 | M343 |
| PL10207 | 7T & 7T | 1T:1T:1T:1T | 660 | 0.3 | 50 | 50 | 4.5 | M343 |
| PL10208 | 4T & 4T | 1T & 1T | 216 | 0.3 | 13 | 13 | 4.5 | M343 |
| PL10209 | 8T & 8T | 1T:1T:1T:1T | 860 | 0.3 | 60 | 60 | 4.5 | M343 |
| PL10210 | 5T & 5T (w/ 5T aux) | 1T & 1T | 340 | 0.3 | 15 | 15 | 0.56 & 0.56 | M343 |
| PL10212 | 6T & 6T (w/2T aux) | 1T & 1T | 480 | 0.3 | 21 | 21 | 0.56 & 0.56 | M343 |
| PL10214 | 7T & 7T (w/3T aux) | 1T & 1T | 660 | 0.3 | 50 | 50 | 0.56 & 0.56 | M343 |
| PL10216 | 8T & 8T | 1T & 1T | 860 | 0.3 | 60 | 60 | 0.56 & 0.56 | M343 |
| PL10230 | 4T | 1T:1T:1T:1T | 54 | 0.3 | 13 | - | 4.5 | M343 |
| PL10231 | 5T (w/5T aux) | 1T:1T:1T:1T | 85 | 0.3 | 15 | 470 | 4.5 | M343 |
| PL10232 | 6T (w/2T aux) | 1T:1T:1T:1T | 120 | 0.3 | 21 | 156 | 4.5 | M343 |
| PL10233 | 7T (w/3T aux) | 1T:1T:1T:1T | 165 | 0.3 | 50 | 200 | 4.5 | M343 |
| PL10234 | 4T | 7T & 7T | 54 | 0.3 | 13 | - | 4.5 | M343 |
| PL10235 | 5T (w/5T aux) | 7T & 7T | 85 | 0.3 | 15 | 470 | 40 & 40 | M343 |
| PL10236 | 6T (w/2T aux) | 7T & 7T | 120 | 0.3 | 21 | 156 | 40 & 40 | M343 |
| PL10237 | 7T (w/3T aux) | 7T & 7T | 165 | 0.3 | 50 | 200 | 40 & 40 | M343 |
| PL10238 | 4T | 1T & 1T | 54 | 0.3 | 13 | - | 40 & 40 | M343 |
| PL10239 | 5T (w/5T aux) | 1T & 1T | 85 | 0.3 | 15 | 470 | 40 & 40 | M343 |
| PL10240 | 6T (w/2T aux) | 1T & 1T | 120 | 0.3 | 21 | 156 | 1.12 & 1.12 | M343 |
| PL10241 | 7T (w/3T aux) | 1T & 1T | 165 | 0.3 | 50 | 200 | 1.12 & 1.12 | M343 |
| PL10242 | 4T | 2T & 1T | 54 | 0.3 | 13 | - | 1.12 & 1.12 | M343 |
| PL10243 | 5T (w/5T aux) | 2T & 1T | 85 | 0.3 | 15 | 470 | 1.12 & 1.12 | M343 |
| PL10244 | 6T (w/2T aux) | 2T & 1T | 120 | 0.3 | 21 | 156 | 1.12 & 1.12 | M343 |
| PL10245 | 7T (w/3T aux) | 2T & 1T | 165 | 0.3 | 50 | 200 | 1.8 & 0.6 | M343 |
| PL10246 | 8T | 1T:1T:1T:1T | 215 | 0.3 | 60 | - | 1.8 & 0.6 | M343 |
| PL10247 | 8T | 2T & 1T | 215 | 0.3 | 60 | - | 1.8 & 0.6 | M343 |
| PL10248 | 8T | 1T & 1T | 215 | 0.3 | 60 | - | 1.8 & 0.6 | M343 |
| PL10249 | 8T | 2T & 1T | 215 | 0.3 | 60 | - | 1.8 & 0.6 | M343 |

- View stock and download literature on the web at <http://www.inrcore.com> - On the Home page, "Search by Part Number"
- To order in Tape & Reel packaging, add the suffix "T" to the part number (i.e. PL10210T)
- INRCORE's standard lead finish is tin/lead (Sn63/Pb37). Parts can be ordered Non-Lead by adding "NL" to the part number (i.e. PL10122NL).

Design Specifications

| Design Type | Maximum Height | Part Numbers |
|---------------------------|----------------|--------------|
| Double Interleave Design* | 10.2mm | PL10201-16 |
| Single Interleave Design | 9.1mm | PL10230-49 |

*Higher efficiency, lower DCR and lower leakage.

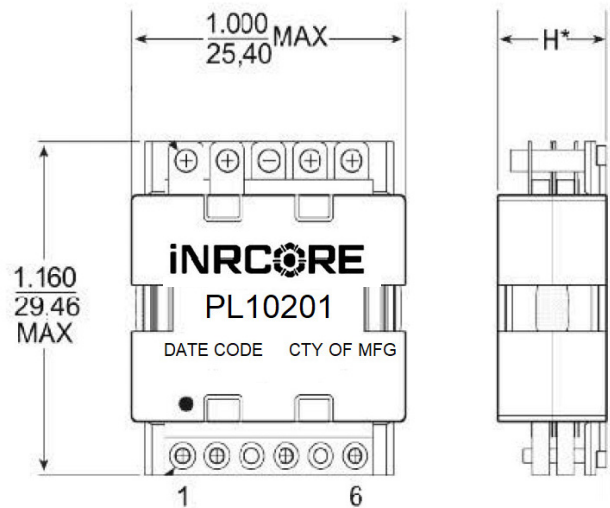

*H - Maximum Height (see table above)

HIGH FREQUENCY PLANAR TRANSFORMERS

Electrical Specification @25°C - Power Rating Up to 140W

| Part Number | Turns Ratio | | Primary Inductance (µH MIN) | Leakage Inductance (µH MIN) | DCR (mΩ MAX) | | | Data Sheet |
|-------------|-------------|-----------|-----------------------------|-----------------------------|--------------|-----------|-------------|------------|
| | Primary | Secondary | | | Primary A | Primary B | Secondary | |
| PL10301 | 4T | 5T | 153 | 0.45 | 17.5 | 17.5 | 7 | M314 |
| PL10302 | 4T | 5T | 194 | 0.45 | 17.5 | 20 | 7 | M314 |
| PL10303 | 5T | 5T | 240 | 0.55 | 20 | 20 | 7 | M314 |
| PL10304 | 5T | 6T | 290 | 0.60 | 20 | 25 | 7 | M314 |
| PL10305 | 6T | 6T | 345 | 0.65 | 25 | 25 | 7 | M314 |
| PL10306 | 4T | 4T | 153 | 0.4 | 7.5 | 7.5 | .875 & .875 | M314 |
| PL10307 | 4T | 5T | 194 | 0.4 | 17.5 | 20 | .875 & .875 | M314 |
| PL10308 | 5T | 5T | 240 | 0.5 | 20 | 20 | .875 & .875 | M314 |
| PL10309 | 5T | 6T | 290 | 0.6 | 20 | 25 | .875 & .875 | M314 |
| PL10310 | 6T | 6T | 345 | 0.6 | 25 | 25 | 1.75 & 1.75 | M314 |
| PL10311 | 4T | 4T | 153 | 0.4 | 17.5 | 17.5 | 1.75 & 1.75 | M314 |
| PL10312 | 4T | 5T | 194 | 0.4 | 17.5 | 20 | 1.75 & 1.75 | M314 |
| PL10313 | 5T | 5T | 240 | 0.4 | 20 | 20 | 1.75 & 1.75 | M314 |
| PL10314 | 5T | 5T | 290 | 0.5 | 20 | 25 | 1.75 & 1.75 | M314 |
| PL10315 | 6T | 6T | 345 | 0.5 | 25 | 25 | 1.75 & 1.75 | M314 |

HIGH FREQUENCY PLANAR TRANSFORMERS

Electrical Specification @25°C - Power Rating Up to 300W

| Part Number | Turns Ratio | | Primary Inductance (µH MIN) | Leakage Inductance (µH MIN) | DCR (mΩ MAX) | | | Data Sheet |
|-------------|-------------|-------------|-----------------------------|-----------------------------|--------------|-----------|-------------|------------|
| | Primary | Secondary | | | Primary A | Primary B | Secondary | |
| PL10401 | 4T & 4T | 1T:1T:1T:1T | 211 | 0.3 | 6.8 | 6.8 | 4.5 | M380 |
| PL10402 | 5T & 5T | 1T:1T:1T:1T | 330 | 0.4 | 8.5 | 8.5 | 4.5 | M380 |
| PL10403 | 6T & 6T | 1T:1T:1T:1T | 423 | 0.6 | 10.2 | 10.2 | 4.5 | M380 |
| PL10404 | 7T & 7T | 1T:1T:1T:1T | 588 | 0.8 | 11.8 | 11.8 | 4.5 | M380 |
| PL10405 | 4T & 4T | 1T:1T:1T:1T | 768 | 1.2 | 13.4 | 13.4 | 4.5 | M380 |
| PL10406 | 8T & 8T | 1T & 1T | 216 | 0.45 | 6.8 | 6.8 | .056 & 0.56 | M380 |
| PL10407 | 5T & 5T | 1T & 1T | 340 | 0.84 | 8.5 | 8.5 | .056 & 0.56 | M380 |
| PL10408 | 6T & 6T | 1T & 1T | 480 | 1.0 | 10.2 | 10.2 | .056 & 0.56 | M380 |
| PL10409 | 7T & 7T | 1T & 1T | 660 | 1.2 | 11.8 | 11.8 | .056 & 0.56 | M380 |
| PL10410 | 8T & 8T | 1T & 1T | 860 | 1.7 | 13.4 | 3.4 | .056 & 0.56 | M380 |

- View stock and download literature on the web at <http://www.inrcore.com> - On the Home page, "Search by Part Number"
- To order in Tape & Reel packaging, add the suffix "T" to the part number (i.e. PL10305T)
- iNRCORE's standard lead finish is tin/lead (Sn63/Pb37). Parts can be ordered Non-Lead by adding "NL" to the part number (i.e. PL10305NL).

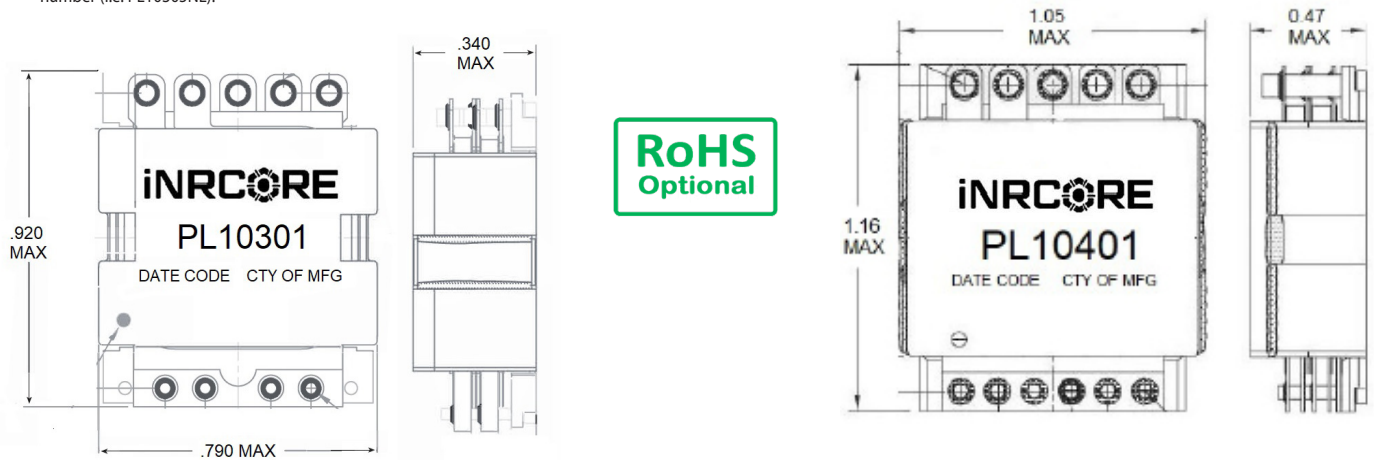

SMT CURRENT SENSE TRANSFORMERS

Electrical Specification @25°C - Operating Temperature -55°C to +130°C - Current Rating: 10A

| Part Number | Turns Ratio | Current Rating (A) | Secondary Inductance (mH MIN) | DCR (mΩ MAX) | | Hipot (Vrms) | Data Sheet |
|-------------|-------------|--------------------|-------------------------------|--------------|-------|--------------|------------|
| | | | | (8-7) | (1-3) | | |
| PL3250 | 1:20 | 10 | 0.08 | 6 | 550 | 1000 | M278 |
| PL3251 | 1:30 | 10 | 0.18 | 6 | 870 | 1000 | M278 |
| PL3252 | 1:40 | 10 | 0.32 | 6 | 1140 | 1000 | M278 |
| PL3253 | 1:50 | 10 | 0.50 | 6 | 1500 | 1000 | M278 |
| PL3254 | 1:60 | 10 | 0.72 | 6 | 2250 | 1000 | M278 |
| PL3255 | 1:70 | 10 | 0.98 | 6 | 4750 | 1000 | M278 |
| PL3256 | 1:100 | 10 | 2.00 | 6 | 5500 | 1000 | M278 |
| PL3257 | 1:125 | 10 | 3.00 | 6 | 6500 | 700 | M278 |

SMT CURRENT SENSE TRANSFORMERS

Electrical Specification @25°C - Operating Temperature -55°C to +130°C - Current Rating: 20A

| Part Number | Turns Ratio | Current Rating (A) | Secondary Inductance (mH MIN) | DCR (mΩ MAX) | | Hipot (Vrms) | Data Sheet |
|-------------|-------------|--------------------|-------------------------------|--------------|-------|--------------|------------|
| | | | | (8-7) | (1-3) | | |
| PL2035 | 1:50 | 20 | 0.50 | 0.75 | 1500 | 500 | M145 |
| PL2264 | 1:100 | 20 | 2.00 | 0.75 | 5500 | 500 | M165 |
| PL3258 | 1:20 | 20 | 0.08 | 0.75 | 550 | 1000 | M279 |
| PL3259 | 1:30 | 20 | 0.18 | 0.75 | 870 | 1000 | M279 |
| PL3260 | 1:40 | 20 | 0.32 | 0.75 | 1140 | 1000 | M279 |
| PL3261 | 1:50 | 20 | 0.50 | 0.75 | 1500 | 1000 | M279 |
| PL3262 | 1:60 | 20 | 0.72 | 0.75 | 2250 | 1000 | M279 |
| PL3263 | 1:70 | 20 | 0.98 | 0.75 | 4750 | 1000 | M279 |
| PL3264 | 1:100 | 20 | 2.00 | 0.75 | 5500 | 1000 | M279 |
| PL3265 | 1:125 | 20 | 3.00 | 0.75 | 6500 | 700 | M279 |
| PL3479 | 1:200 | 20 | 8.00 | 0.75 | 17000 | 700 | M279 |

SMT CURRENT SENSE TRANSFORMERS

Electrical Specification @25°C - Operating Temperature -55°C to +130°C - Current Rating: 15A

| Part Number | Turns Ratio | Current Rating (A) | Secondary Inductance (mH MIN) | DCR (mΩ MAX) | | Hipot (Vrms) | Data Sheet |
|-------------|-------------|--------------------|-------------------------------|--------------|-------|--------------|------------|
| | | | | (1,3-2,4) | (5-6) | | |
| PL1170 | 1:1:100 | 15.00 | 14.8 | 1.5 | 930 | 500 | M133 |
| PL1961 | 1:1:200 | 15.00 | 59.2 | 2.3 | 4200 | 500 | M150 |

SMT CURRENT SENSE TRANSFORMERS

Electrical Specification @25°C - Operating Temperature -55°C to +130°C - Current Rating Up to 35A

| Part Number | Turns Ratio | Current Rating (A) | Secondary Inductance (mH MIN) | DCR (mΩ MAX) | | Hipot (Vrms) | Data Sheet |
|-------------|-------------|--------------------|-------------------------------|--------------|-------|--------------|------------|
| | | | | (11-12) | (2-4) | | |
| PL1839 | 50 : 1 | 35 | 1.4 | 0.42 | 700 | 1800 | M302 |
| PL1808 | 100 : 1 | 35 | 5.6 | 0.42 | 1400 | 1800 | M302 |
| PL1840 | 200 : 1 | 35 | 22.4 | 0.42 | 2900 | 1800 | M302 |

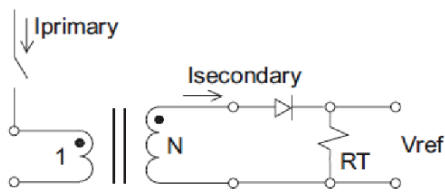

APPLICATION CIRCUIT

**RoHS
Optional**

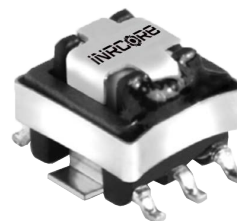

AUDIO TRANSFORMERS

Electrical Specification @25°C - Operating Temperature: -40°C to +130°C

| Part Number | Turns Ratio Pri: Sec +/-2% | Primary Impedance (Ω +/-10%) | Insertion Loss (dB MAX) 1KHz/1.0 Vrms | DCR (Ω MAX) | | Hipot (Vrms) | Data Sheet |
|-------------|-------------------------------|---------------------------------|---|----------------|-------|-----------------|------------|
| | | | | (2-4) | (7-9) | | |
| PL3141 | 1.1 | 600 | 1.55 | 55 | 67 | 1500 | M358 |
| PL3183 | 1.1 | 150 | 1.5 | 12 | 14 | 1250 | M508 |

GATE DRIVE TRANSFORMERS

1000VDC to 1500VDC - Basic & Functional Insulation

| Part Number | Turns Ratio | Pri-Sec Insulation | MAX (v*usec) ¹ | Primary Inductance (μH MAX) | Leakage Inductance ² (μH MAX) | DCR (Ω MAX) | | Package L/W/H (in.) | Insulation | Data Sheet |
|-------------|-------------|--------------------|---------------------------|-----------------------------|--|-------------|-----------|---------------------|------------|------------|
| | | | | | | Primary | Secondary | | | |
| PL3172NL | 1:1 | 1500 Vrms | 9.7 | 1200 | 0.50 | 0.91 | 0.91 | .355/.340/.300 | FUNCTIONAL | M297 |
| PL1960 | 1:1 | 1500VDC | 9.7 | 785 | 0.46 | 0.60 | 0.60 | .265/.340/.140 | FUNCTIONAL | M149 |
| PL3280 | 1:1:1 | 1500Vrms | 12.7 | 800 | 0.65 | 0.75 | 0.75 | .340/.265/.140 | FUNCTIONAL | M296 |
| X-1569NL | 1:1:1 | 1500VDC | 45.1 | 3330 | 0.70 | 1.60 | 1.60 | .355/.340/.300 | FUNCTIONAL | M258 |
| X-1622NL | 1:1:1 | 1500Vrms | 60.0 | 1400 | 1.50 | 1.60 | 1.5/1.5 | .355/.340/.300 | FUNCTIONAL | M295 |
| PL3057NL | 2.5:1:1 | 1500Vrms | 27.2 | 1200 | 0.80 | 0.91 | .38/.38 | .355/.340/.300 | BASIC | M294 |
| PL2973 | 1:1 | 1500VDC | 27.2 | 1200 | 0.50 | 0.91 | 0.91 | .355/.340/.300 | BASIC | M299 |
| PL3140 | 2:1:1 | 1500Vrms | / | 1200 | 0.60 | 0.91 | 0.46 | .355/.340/.300 | FUNCTIONAL | M383 |
| PL3002 | 1:1:1 | 1600Vrms | 866 | 5000 | 0.50 | 6 | 7.2/7.2 | 0.75/0.75/0.50 | FUNCTIONAL | M386 |
| PL2148NL | 1:1 | 1500Vrms | 55 | 1486 | 0.80 | 1.15 | 1.15 | .355/.340/.300 | FUNCTIONAL | M387 |
| PL3159 | 1:1:1 | 2700VDC | 21 | 507 | 0.40 | 0.85 | 0.85/0.85 | .315/.200/.118 | FUNCTIONAL | M388 |
| PL3212NL | 1:1:1 | 3000Vrms | 95 | 450 | 0.50 | 0.08 | 0.072 | .810/.750/.480 | BASIC | M389 |
| PL3215NL | 1:1:1 | 6000Vrms | 115 | 686 | 0.80 | 0.71 | 0.71/0.71 | .750/.810/.480 | BASIC | M394 |
| PL3445NL | 1:1:1 | 1500Vrms | 85 | 7200 | 2.0 | 3.0 | 3/3 | .355/.340/.300 | FUNCTIONAL | M395 |
| PL3602NL | 2:1:1 | 4000 Vrms | 375 | 1500 | 8.0 | 2.2 | 1.6/1.6 | .650/.500/.599 | FUNCTIONAL | M396 |
| PL3716 | 1:1 | 700Vrms | 126 | 2500 | 4.0 | 5.8 | 6.2 | .650/.443/.400 | FUNCTIONAL | M392 |
| PL3839NL | 1:1:1 | 2500Vrms | 48 | 1500 | TBD | 1.5 | 1.5/1.5 | .572/.512/.340 | FUNCTIONAL | M393 |
| PL3840 | 1:1 | 10KVrms | 320 | 1850 | 15 | 0.133 | 0.12/.085 | 1.319/1.417/.728 | FUNCTIONAL | M397 |
| PL1863 | 2:1:1 | 2500VDC | 27.2 | 1200 | 0.60 | 0.91 | .46/.46 | .355/.340/.300 | FUNCTIONAL | M398 |
| PL1903 | 1:1 | 1500Vrms | 15.4 | 750 | 0.75 | 0.88 | 0.7 | .470/.350/.160 | BASIC | M410 |
| PL2064 | 1:2.5:2.5 | 3750Vrms | 10.88 | 162 | 0.24 | 0.28 | .56/.56 | .665/.421/.267 | BASIC | M412 |
| PL2072 | 1:1 | 1500Vrms | 12 | 403.2 | 0.46 | 0.685 | .685 | .345/.265/.098 | FUNCTIONAL | M367 |
| 10B-1002 | 1:1 | 700Vrms | 24 | 10,000 | 30 | 11 | 11 | .650/.443/.440 | FUNCTIONAL | M464 |

- The maximum volt-μsec rating limits the peak flux density to 2200 Gauss when used in a unipolar drive application. For bi-polar drive applications a maximum volt-μsec of two times this rating is acceptable (ie: 2* (volt*μsec rating) Volt*μsec = (voltage applied to the primary) * dutycycle / Frequency = V * alpha / Freq_Hz = V * μsec
 - Leakage inductance is measured at primary terminals with all secondaries shorted.
- View stock and download literature on the web at <http://www.inrcore.com> - On the Home page, "Search by Part Number"
 - To order in Tape & Reel packaging, add the suffix "T" to the part number (i.e. PL3280T)
 - INRCORE standard lead finish is tin/lead (Sn63/Pb37). Parts can be ordered Non-Lead by adding "NL" to the part number (i.e. PL2973NL).



Space Development/Testing/Validation Capabilities

- MIL-STD-981
 - NASA EEE-INST-002
 - NASA-STD 8739.3
 - IPC-STD-001DS
 - ESA
 - IPC-610
- MIL-PRF-21038
 - MIL-PRF-27
 - MIL-STD-202
 - ECSS-Q-ST-70-38C
 - UL 60601
 - CSA C22.2
- AEC-Q200
 - MIL-STD-883
 - Custom Magnetic Power
 - Signal Design/Build
 - MIL-STD-810
 - IPC/WHMA-A-620

Manufacturing Capabilities

- Bobbin Winding
 - SMT Board Assembly
 - In-House Machine Shop
 - Custom Lead Forming
- Toroid Winding
 - Electrical/Mechanical Assembly
 - Automated Electrical Test
 - E.S.S. Capability
 - Automated Solder Tinning
- AS9100D-Certified Facilities
 - Harness Assembly
 - Transfer Molding
 - Vacuum Encapsulation

Space Program Participation

- ISS
- Orion
- World View III
- MagICE
- HPCA
- James Webb Telescope

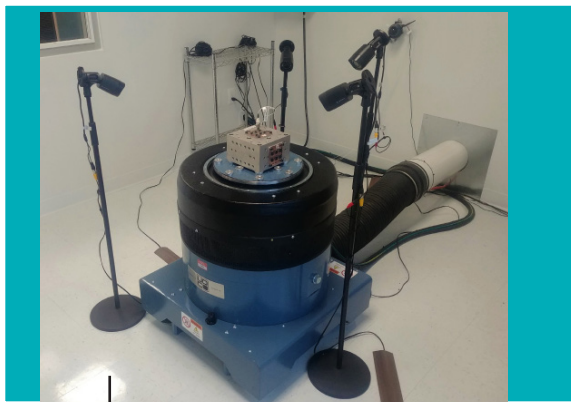

Shock and Vibration Testing Table

Real Time 3-D X-Ray Inspection

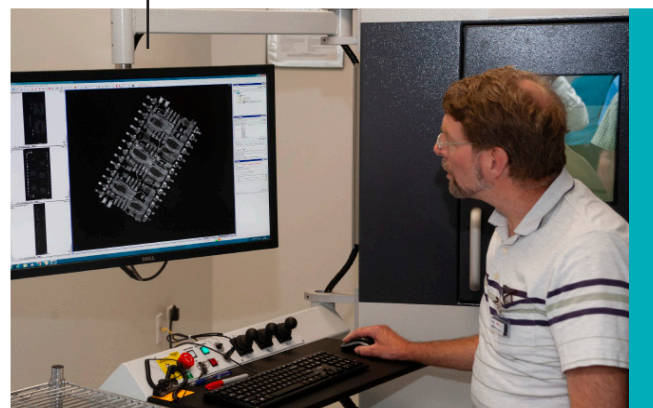

| PRODUCT CAPABILITY | PACKAGING | MAX POWER | MAX CURRENT | FREQUENCY |
|--|----------------------------------|---------------|-------------|-------------|
| SINGLE INDUCTORS | Lamination, Toroidal, Tape Wound | 4KVA | | 15 - 2MHz |
| COMMON MODE CHOKES 1/3 Phase | Lamination, Toroidal, Tape Wound | - | 500A | 15 - 2400Hz |
| CHOKES 3 PHASE (LINE FILTERING) | Lamination, Tape Wound | - | 500A | 15 - 2400Hz |
| POWER TRANSFORMERS 1 Phase | Lamination, Toroidal, Tape Wound | 10KVA | - | 15 - 1200Hz |
| TRANSFORMERS Laminated 3 Phase | Lamination, Toroidal, Tape Wound | 10KVA | - | 15 - 1200Hz |
| TRANSFORMERS - Switch Mode | Planar, Bobbin Wound, Toroidal | 10KVA | - | 20K- 1MHz |
| INDUCTORS - Switchmode Buck/Boost | Toroidal, Bobbin Wound | 500VA | - | 20K- 1MHz |
| TRANSFORMERS - Current Sense | Toroidal, Bobbin Wound | 4KVA (burden) | - | 15- 1MHz |
| TRANSFORMER MODULES -Current Sense 1/3 PHASE | Toroidal, Bobbin Wound | 4KVA (burden) | - | 15- 1MHz |
| TRANSFORMERS Gate Drive | Toroidal, Bobbin Wound | - | - | 20KHz- 1MHz |
| CURRENT SENSE TRANSFORMERS | Lamination, Toroidal, Tape Wound | 10KVA | | 15 - 1200Hz |

Testing Services

Testing capabilities for product qualification and design validation

ELECTRICAL

- Inductance with or without DC
- Turns Ratio
- HI-POT - Vac up to 5kv, Vdc up to 6kV
- Insulation Resistance
- Distortion
- Pulse Testing
- Thermal Rise
- Impedance
- Q (up to 1 Mhz)
- DCR
- SRF (up to 3Ghz)
- Leakage Inductance
- Voltage Ratio

MECHANICAL

- Mechanical Shock
- Mechanical Vibration
- Solderability
- Resistance to Soldering Heat

ENVIRONMENTAL

- Humidity (to 90% RH)
- Moisture Resistance
- Thermal Shock
- Thermal Cycling
- High/Low Temperature Storage
- Steam Aging

ANALYTICAL

- 3D Real Time X-ray
- Plating composition analysis
- Detailed Inspection Plans
- First Article Inspection to AS9102



Inductor Design Worksheet

Contact

Name: _____ Company: _____
E-mail: _____ Phone: _____

Electrical

Common Mode Differential Mode
 PFC Resonant

For PFC inductor only, please specify RMS current at 100-120Hz: _____

And peak to peak current for operation frequency: _____

| | Winding 1 | Winding 2 | Winding 3 |
|---|-----------|-----------|-----------|
| Inductance Range: | _____ | _____ | _____ |
| Rated Current: | _____ | _____ | _____ |
| Ripple Current: | _____ | _____ | _____ |
| Q(Quality factor if relevant): | _____ | _____ | _____ |
| SRF(Self-resonant frequency if relevant) minimum: | _____ | | |

Mechanical

Mounting type:
 Surface mount Through hole
Other: _____
Maximum size:
Length _____ Width _____ Height _____

Safety and environmental requirements

Dielectrical withstanding voltage: _____ DC RMS
Ambient temperature range (°C) : _____
Temperature rise, maximum (°C) : _____
Lead/terminal finish: tin/lead Pure tin
Other: _____

Other

Sample quantity: _____ Date needed: _____
EAU(Estimated annual quantity): _____
Production start date: _____
Budgetary target price (USD) : _____
Specific application for this product: _____
Program name: _____
Restricted/ITAR: Yes No

Power Transformer Design Worksheet

Contact

Name: _____
E-mail: _____

Company: _____
Phone: _____

Electrical

Total output power of power supply: _____

Switching frequency (kHz): _____

Maximum Duty Cycle: _____

Topology

- Flyback Continuous Flyback Discontinuous
 Forward Converter Active clamp forward Two-switch forward
 Push pull Half bridge Full bridge

Other: _____

Primary

Input voltage range: _____

Desired inductance (if known): _____

Turns ratio (if known): _____

Input current (if known): _____

other: _____

Secondary(ies)

| | S1 | S2 | S3 | S4 | S5 | S6 |
|-----------------|-------|-------|-------|-------|-------|-------|
| Output voltage: | _____ | _____ | _____ | _____ | _____ | _____ |
| Output current: | _____ | _____ | _____ | _____ | _____ | _____ |
| Diode drop: | _____ | _____ | _____ | _____ | _____ | _____ |

Mechanical

Mounting type:

- Surface mount Through hole

Other: _____

Maximum size:

Length _____ Width _____ Height _____

Safety and environmental requirements

Agency requirement: IEC _____ UL _____ CSA _____

Insulation class: Functional Basic Supplementary Reinforced

Dielectrical withstanding voltage: _____ DC RMS

Ambient temperature range (°C) : _____

Temperature rise, maximum (°C) : _____

Lead/terminal finish: tin/lead Pure tin

Other: _____

Other

Sample quantity: _____ Date needed: _____

EAU(Estimated annual quantity): _____

Production start date: _____

Budgetary target price (USD) : _____

Specific application for this product: _____

Program name: _____

Restricted/ITAR: Yes No