



2020 PRODUCT CATALOG

www.inrcore.com



inRCORE



**AS 9100D
CERTIFIED
ISO 9001**

iNRCORE

iNRCORE designs and manufactures magnetic components that transmit high-speed, mission-critical signal and power in the harshest operating conditions. Our solutions have operated on the frontlines of defense to the frontiers of space exploration. For over 70 years, iNRCORE has deployed reliable and intelligent solutions to power next-generation systems.

Our expert engineering teams and award-winning quality and service exceed our customer demanding expectations. Whether we are working to assemble a component to meet your custom design or screening your products to qualify for a critical mission, iNRCORE's solutions are Rugged to the Core.



OUR MISSION

- To serve Defense, Aerospace, Space and High-Performance Industrial customers with the highest level of service focusing on building relationships with mutual benefits.
- To design and manufacture magnetic solutions exceeding customers' satisfaction in terms of quality, reliability and delivery.
- To be competitive while remaining a world-class source for specialty solutions.

Table of Contents

iNRCORE Signal Products Pages 4- 12

IEEE 1394B Firewire Transceiver Line	Page 4
Copperhead™ Series Transceiver Line Interface Modules (Active)	Page 5
Copperhead™ High Speed Dual Transformers (Dual Passive)	Page 5
Copperhead™ High Speed Single Transformers (Single Passive)	Page 5
Digital Video Isolation Transformers (3G and Standard)	Page 5
SMPTTE Digital Video Baluns (3G and Standard)	Page 5
High-Frequency Balun Adaptors	Page 6
Ethernet/AFDX (10/100)	Page 7
Ethernet/AFDX (10/100/1000/10000)	Page 8
High Isolation Ethernet (10KV)	Page 9
MIL-STD-1553 Interface Transformers (Non-QPL)	Page 10
MIL-STD-1553 Interface Transformers (Low Profile and Stacked)	Page 11
MIL-STD-1553 Interface Transformers (Low Profile Miniature Series)	Page 11
QPL Series - Qualified to MIL-PRF-21038/27	Page 11
PULSE Transformer/Data Transformer/CAN BUS	Page 12

iNRCORE Power Products Pages 13-18

Toroid Power Inductors (SLED Series)	Page 13
SMT Common Mode Chokes (SLIC Series)	Page 13
SMT Power Inductors (SLIC, HCCI-80) Series	Page 14
SMT Power Inductors (Toroid, SLED Series)	Page 14
SMT Power Inductors (Toroid, POGO Series)	Page 14
SMT Common Mode Inductors (POGO Series)	Page 15
SMT Power Inductors (Shielded Drum Core)	Page 15
SMT Planar Power Inductors	Page 17
High Frequency Planar Power Transformers	Page 18
SMT Current Sense Transformers	Page 20
Audio Transformers	Page 21
Gate Drive Transformers	Page 21

Custom Capabilities & Designer Worksheets Page 22-25

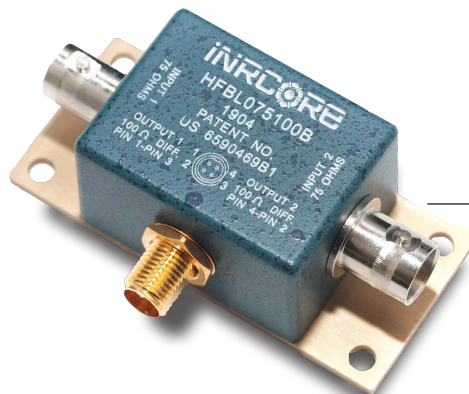

SMPTE Video Balun Adaptor
HFBL075100B (pg. 6)

INRCORE SIGNAL PRODUCTS

iNRCORE has a full line of **High-Speed Transformers** supporting Ethernet IEEE802.x, AFDX systems, SMPTE Serial Video, Fibre Channel and IEEE1394b applications. A unique line of **Line Interface Transceivers** supports a wide range of cable impedances and data rates up to 2.125 Gbps. iNRCORE's products have been utilized for a variety of applications, from Fighter Jets to Space programs. iNRCORE continues to offer tin/lead termination finishes for Military, Space and Aerospace applications requiring the highest grade of reliability.

Parts can also be purchased with pure tin lead finishes where RoHS and REACH compliance are required. In addition to providing this full catalog of off-the-shelf products, more than 50% of iNRCORE's business is customizing parts to customer requirements. iNRCORE can provide custom design services, as well as perform specialized screening and qualification testing.

COPPERHEAD™ SERIES TRANSCEIVER LINE INTERFACE MODULES - ACTIVE

High Speed Data and Communications over 100+ Meters of Copper

- | Military temperature range -55°C to +125°C
- | Low transmit/receive jitter
- | Low power dissipation; 450 mW typical
- | ECL or CML logic interface
- | 1500V Isolation Voltage
- | Surface mount – pick-and-place compatible
- | Withstands infrared and vapor phase soldering 225°C MAX Temperature



ORDERING INFORMATION

TM 531 D S A 1 (XX)

- (XX) - Custom Product Designator
- blank - No transmit driver
- 1 - 1100 mV output transmit driver and military temperature range
- 2 - 1100 mV output transmit driver and industrial temperature range
- 5 - Active cable equalizer circuit
- A - 5.00 Volt
- B - 3.30 Volt
- S - Impedance matched for STP and twinax (150 ohm)
- U - Impedance matched for unshielded twisted pair (100 ohm)
- V - Impedance matched for video and mini-coax (75 ohm)
- C - Impedance matched for coax (50 ohm)
- D - Gull wing DIP 28-pin package: 0.800"L x 0.400"W x 0.200"H
- F - Gull wing flat pack 28-pin package: 0.760"L x 0.610"W x 0.125"H
- H - Gull wing half DIP 16-pin package: 0.500"L x 0.300"W x 0.180"H
- 133 - 132.8125 Mbaud version 1/8 Speed Fibre Channel/ATM
- 266 - 265.625 Mbaud version 1/4 Speed Fibre Channel
- 531 - 531.25 Mbaud version 1/2 Speed Fibre Channel
- 1062 - 1.0625 Gbaud version Full Speed Fibre Channel
- 1250 - 1.250 Gbaud version, Gigabit Ethernet (both short haul and long haul)
- 1485 - 1.485 Gbaud version, SMPTE

IEEE 1394B FIREWIRE TRANSCEIVER LINE INTERFACE MODULES

Part Number	Transmitter/Receiver Data Rate		Transmitter Differential Signal Level - V _{OUT} (mV)			Total Power Dissipation (mW)		Receiv Turns Ratio	Receive Primary Inductance-Lm(uH)	Receive Insertion Loss (dB)	Transmit/Receive Return Loss (dBMIN)	Package L/W/H (in.)	Data Sheet	IEEE 1394B Speed
	MIN	MAX	MIN	TYP	MAX	(mW)	TYP	MIN	(dBMax)	(dBMIN)				
TM1062TXDUA	246	1062	1200	1300	1500	232	1:1	4.5	-2	-12	.800 / .400 / .200	M103	S200-S800	
TM1062TXHUA	246	1062	1200	1300	1500	232	1:1	4.5	-2	-12	.510 / .300 / .140	M103	S200-S800	
TM1062TX3DUA	246	1062	1200	1300	1500	700	1:1	4.5	-2	-12	.800 / .400 / .185	M103	S200-S800	
TM125TXHUA	98	246	1200	1300	1500	232	1:1	40	-2	-12	.510 / .300 / .140	M186	S100-S200	
TM1062DUXB	246	1062	1200	1300	1500	232	1:1	4.5	-2	-12	.800 / .400 / .200	M186	S200-S800	
TM1062HUXB	246	1062	1200	1300	1500	232	1:1	4.5	-2	-12	.510 / .300 / .140	M186	S200-S800	
TM1062DU3XB	246	1062	1200	1300	1500	232	1:1	4.5	-2	-12	.800 / .400 / .200	M186	S200-S800	
TM125TXHUA	98	246	1200	1300	1500	232	1:1	40	-2	-12	.510 / .300 / .140	M186	S100-S200	

* Parts listed on data sheet M103 are manufactured in the United States. Data sheet M186 contains equivalent parts manufactured in China.

- View stock and download literature on the web at <http://www.inrcore.com> - On the Home page, "Search by Part Number"
- Applications: Fibre Channel, Gigabit Ethernet, SONET, HDTV, IEEE 1394B, SMTPE.
- iNRCORE's standard lead finish is tin/lead (Sn63/Pb37). Parts can be ordered Non-Lead by adding the suffix "NL" to the part number (i.e. TM1062DUXBNL).
- To order in Tape & Reel packaging, add the suffix "T" to the part number (i.e. TM1062DUXBT)



COPPERHEAD™ HIGH SPEED DUAL TRANSFORMERS - PASSIVE

Part Number	Package L/W/H (in.)	Turns Ratio (±5%)	Primary Inductance (µH MIN)	Rise Time (ps: MAX @20-80%)	DC Resistance (Ω MAX)	Hipot (Vrms MIN)	Insertion Loss (dB MAX)	Application Nominal Bit Rate (Mbps)	Data Sheet
T-330SCT	.500/.435/.180	1CT:1CT	26.0	350	0.2	1500	-1.5 (15-165 MHz)	265.6 (quarter speed)	M105
T-531SCT	.500/.375/.235	1CT:1CT	7.5	325	0.2	1500	-2.0 (50-265 MHz)	531 (half speed)	M105
T-1062SCT	.500/.435/.180	1CT:1CT	3.75	280	0.2	1500	-2.0 (100-531 MHz)	1062.50 (full speed)	M105
T-1250SCT	.500/.435/.180	1CT:1CT	3.75	280	0.2	1500	-2.0 (125-650MHz)	1,250 (Gigabit Ethernet)	M105
T-1485SCT	.500/.435/.180	1CT:1CT	3.75	280	0.2	1500	1,485 (SMPTE)	1,485 (SMPTE)	M105
T-3200SCT	.500/.375/.235	1:1	0.70	280	0.2	1500	-4.5 (500-1600MHz)	3200	M105

COPPERHEAD™ HIGH SPEED SINGLE TRANSFORMERS - PASSIVE

Part Number	Package L/W/H (in.)	Turns Ratio (±5%)	Primary Inductance (µH MIN)	Rise Time (ps: MAX @20-80%)	DC Resistance (Ω MAX)	Hipot (Vrms MIN)	Insertion Loss (dB MAX)	Application Nominal Bit Rate (Mbps)	Data Sheet
T-330ACT	.230/.265/.215	1CT:1CT	26.0	350	0.2	1500	-1.5 (15-165 MHz)	265.5 (quarter speed)	M131
T-531ACT	.230/.265/.215	1CT:1CT	7.5	325	0.2	1500	-2.0 (100-265 MHz)	531 (half speed)	M131
T-1062ACT	.230/.265/.215	1CT:1CT	3.75	280	0.2	1500	-2.0 (100-531 MHz)	1,062.5 (full speed)	M131
T-1250ACT	.230/.265/.215	1CT:1CT	3.75	280	0.2	1500	-2.0 (200-620 MHz)	1,250 (Gigabit Ethernet)	M131
T-1485ACT	.230/.265/.215	1CT:1CT	3.75	280	0.2	1500	-2.0 (200-742.5 MHz)	1,485 (SMPTE)	M131

HIGH-FREQUENCY SMT BALUNS

Part Number	Impedance Unbalanced (Ω)	Impedance Balanced (Ω)	Insertion Loss (dB MAX) 1.0 MHz - 1.485Gbps	Return Loss (dB MIN) 1.0 MHz - 1.485Gbps	Datasheet
T-050078	50	78	-2	12	M132
T-050100	50	100	-2	12	M132
T-050150	50	150	-2	12	M132
T-075100	75	100	-2	12	M132

• Designed for standard test equipment with SMA connectors. Wide bandwidth: 1.0 MHz to 1.2GHz.

SMPTE DIGITAL VIDEO BALUNS - 3G AND STANDARD (1.485Gbps)

Part Number	Package L/W/H (in.)	Data Rate (Gbps)	Impedance Unbalanced (Ω)	Impedance Balanced (Ω)	Insertion Loss (dB MAX) @1.5GHz	Return Loss (dB MIN) @1.5GHz	Data Sheet
TA-0751003G	.290/.240/.150	2.973	75	100	-2.0	12.0	M551
TA-0751503G	.290/.240/.150	2.973	75	150	-2.0	10.0	M551
TA-0501003G	.290/.240/.150	2.973	50	100	-2.0	10.0	M551
TA-075100G	.290/.240/.150	1.485	75	100	-2.0	12.0	M551
TA-075150G	.290/.240/.150	1.485	75	150	-2.0	10.0	M551
TA-050100G	.290/.240/.150	1.485	50	100	-2.0	10.0	M551

- View stock and download literature on the web at <http://www.inrcore.com> - On the Home page, "Search by Part Number"
- Dual Transformers are designed specifically for Point-to-Point Communication using STP, QUADRIX or TWINAX cable (comparable with 50,75,100 & 150Ω cable)
- Applications: Fibre Channel, Gigabit Ethernet, SONET, HDTV, IEEE 1394B, SMPTE.
- iNRCORE's standard lead finish is tin/lead (Sn63/Pb37). Parts can be ordered Non-Lead by adding "NL" to the part number (i.e. T-1250ACTNL).
- To order in Tape & Reel packaging, add the suffix "T" to the part number (i.e. T-330ACTT)

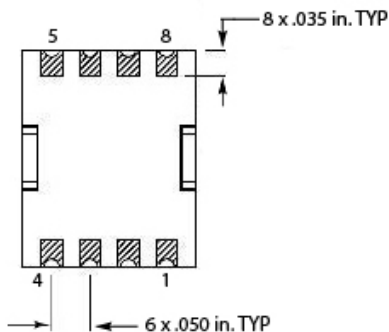
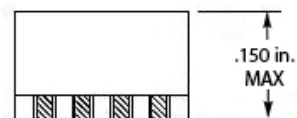
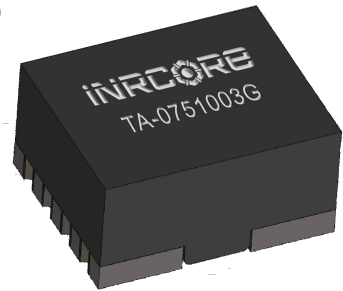

INSTRUMENTATION BALUN ADAPTERS

Part Number	Impedance Unbalanced (Ω)	Impedance Balanced (Ω) 1.485Gbps	Insertion Loss (dB MAX) 1.485Gbps	Return Loss (dB MIN) 1.0MHz -1.2 GHz	Datasheet
HFB050150	50	150	-2	15	M100
HFB050100	50	100	-2	15	M100

- Transforms 150 Ω or 100 Ω , balanced, differential signal, to 50 Ω single-ended signal.
- Designed for standard test equipment with SMA connectors. Wide bandwidth: 1.0 MHz to 1.2GHz.

SMPTE VIDEO BALUN ADAPTORS - STANDARD (1.485Gbps)

Part Number	Unbalanced (Ω)	Impedance Balanced (Ω)	Insertion Loss dB MAX (1.485 Gbps)	Jitter Dj (pSec. MAX) 1.485 Gbps	Bracket	Datasheet
HFB075100A	75	100	-2.0	110.0	NO	M146
HFB075100B	75	100	-2.0	110.0	NO	M146
HFB075150A	75	150	-2.0	110.0	NO	M146
HFB075150B	75	150	-2.0	110.0	NO	M146
HFBL075100A	75	100	-2.0	110.0	YES	M146
HFBL075100B	75	100	-2.0	110.0	YES	M146
HFBL075150A	75	150	-2.0	110.0	YES	M146
HFBL075150B	75	150	-2.0	110.0	YES	M146
HFBM075100B	75	100	-2.0	110.0	YES	M147
HFBM075100C *	75	100	-2.0	110.0	YES	M147
HFBM075100S **	75	100	-2.0	110.0	YES	M305
HFBM075100L	75	100	-2.0	110.0	YES	M265
HFB075100D	75	100	-2.0	110.0	YES	M283

- Transforms 100 Ω or 150 Ω balanced differential signal to 75 Ω , grounded, unbalanced signal.
 - Designed for SMPTE-292M. HDTV application at 1.485Gbps data rate.
- * HFBM075100C - 75 Ω Connectors: Triax Ω , Trompeter BJ770
 ** HFBM075100S - 75 Ω Connectors: BNC

SMPTE VIDEO BALUN ADAPTORS - 3G

Part Number	Unbalanced (Ω)	Impedance Balanced (Ω)	Insertion Loss (dB MAX) 2.973 Gbps	Jitter Dj (pSec. MAX) 2.973 Gbps, PN 7	Bracket	Datasheet
HFB3G075100A	75	100	-6.5	65.0	NO	M416
HFB3G075100B	75	100	-6.5	65.0	NO	M416
HFB3GL075100A	75	100	-6.5	65.0	YES	M416
HFB3GL075100B	75	100	-6.5	65.0	YES	M416
HFB3G075150A	75	150	-6.5	65.0	NO	M416
HFB3G075150B	75	150	-6.5	65.0	NO	M416
HFB3GL075150A	75	150	-6.5	65.0	YES	M416
HFB3GL075150B	75	150	-6.5	65.0	YES	M416

- Transforms 100 Ω or 150 Ω balanced differential signal to 75 Ω , grounded, unbalanced signal.
- Designed for SMPTE-424M/425M, 2,973Gbps.

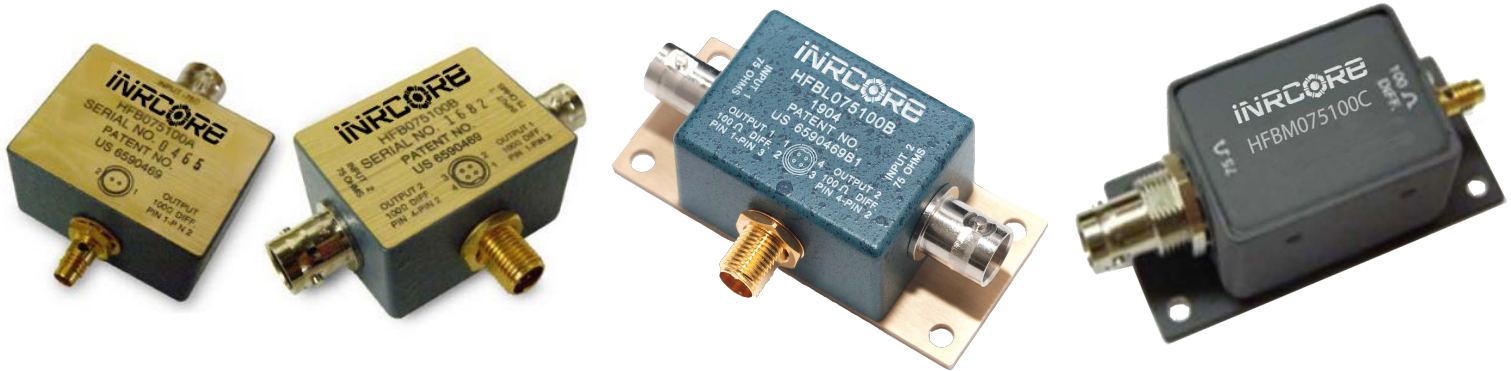

INRCORE ETHERNET / AFDX							
10/100Base-TX							
Number of Ports	Part Number	Turns Ratio	Configuration		Style	Package	Data Sheet
			RX	TX			
Single	100B-1001	1CT:1CT	T,C	T,C,S	12-pin SMT	.630/.470/.200	M101
	100B-1001X	1CT:1CT	T,C	T,C,S	12-pin SMT	.630/.470/.200	M101
	100B-1001F	1CT:1CT	T,C	T,C,S	12-pin SMT	.630/.470/.200	M101
	100B-1001FX	1CT:1CT	T,C	T,C,S	12-pin SMT	.630/.470/.200	M101
	100B-1003	1CT:1CT	T,C	T,C	16-pin SMT	.500/.265/.235	M101
	100B-1003X	1CT:1CT	T,C	T,C	16-pin SMT	.500/.265/.235	M101
	100B-1018	1CT:1CT	T,C	T,C,S	12-pin SMT	.583/.470/.180	M189
	100B-1018X	1CT:1CT	T,C	T,C,S	12-pin SMT	.583/.470/.180	M189
	100B-1027	1CT:1CT	T,C	T,C,S	16-pin SMT	1.00/.390/.235	M197
	100B-1027X	1CT:1CT	T,C	T,C,S	16-pin SMT	1.00/.390/.235	M197
	100B-1035	1CT:1CT:	T,C	T,C	12-pin SMT	.500/.347/.088	M316
	100B-1051	1CT:1CT	T,C	T,C	24-pin SMT	.590/.520/.155	M440
	100B-1054X	1CT:1CT	T,C	T,C	16-pin SMT	.500/.358/.236	M441
Dual	100B-2002	1CT:1CT	T, C	T,C	24-pin SMT	.518/.595/.241	M110
	100B-2002X	1CT:1CT	T, C	T,C	24-pin SMT	.518/.595/.241	M110
	100B-2002F	1CT:1CT	T, C	T,C	24-pin SMT	.518/.595/.241	M110
	100B-2002FX	1CT:1CT	T, C	T,C	24-pin SMT	.518/.595/.241	M110
Quad	100B-4005	1CT:1CT	T,C	T,C	40-pin SMT	1.125/.480/.280	M203
	100B-4005X	1CT:1CT	T,C	T,C	40-pin SMT	1.120/.480/.280	M203
	100B-4005F	1CT:1CT	T,C	T,C	40-pin SMT	1.125/.480/.280	M203
	100B-4005FX	1CT:1CT	T,C	T,C	40-pin SMT	1.120/.480/.280	M203
	100B-4009	1CT:1CT	T,C	T,C	40-pin SMT	1.125/.480/.280	M190
	100B-4009X	1CT:1CT	T,C	T,C	40-pin SMT	1.125/.480/.280	M190
	100B-4009F	1CT:1CT	T,C	T,C	40-pin SMT	1.125/.480/.280	M190
	100B-4009FX	1CT:1CT	T,C	T,C	40-pin SMT	1.125/.480/.280	M190
	100B-4011	1CT:1CT	T,C	T,C	40-pin SMT	1.125/.480/.280	M151
	100B-4011X	1CT:1CT	T,C	T,C	40-pin SMT	1.125/.480/.280	M151
	100B-4011F	1CT:1CT	T,C	T,C	40-pin SMT	1.125/.480/.280	M151
	100B-4011FX	1CT:1CT	T,C	T,C	40-pin SMT	1.125/.480/.280	M151
	100B-4018	1CT:1CT	T,C	T,C	40-pin SMT	1.110/.630/.225	M448
	100B-4019	1CT:1CT	T,C	T,C	40-pin SMT	1.08/.630/.226	M449
100B-4020	1CT:1CT	C,T,C	C,T,C	40-pin SMT	1.090/.360/.236	M307	

- View stock and download literature on the web at <http://www.inrcore.com> - On the Home page, "Search by Part Number"
- iNRCORE's standard lead finish is Tin/Lead (Sn63/Pb37). Parts can be ordered Non-Lead by adding "NL" to the part number (i.e. 100B-2002XNL).
- To order in Tape & Reel packaging, add the suffix "T" to the part number (i.e. 100B-4009FT)



INRCORE ETHERNET / AFDX							
1000Base-T / 10GBase-T							
Number of Ports	Part Number	Turns Ratio	Configuration		Style	Package	Data Sheet
			RX	TX			
Single	1000B-5001	1CT:1CT	T,C,S	T,C,S	24-pin SMT	.695/.635/.230	M1061
	1000B-5001X	1CT:1CT	T,C,S	T,C,S	24-pin SMT	.695/.635/.230	M1061
	1000B-5001F	1CT:1CT	T,C,S	T,C,S	24-pin SMT	.695/.635/.230	M1061
	1000-5001FX	1CT:1CT	T,C,S	T,C,S	24-pin SMT	.695/.635/.230	M1061
	1000B-5002	1CT:1CT	T,C	T,C	24-pin SMT	.695/.635/.230	M106
	1000B-5002X	1CT:1CT	T,C	T,C	24-pin SMT	.695/.635/.230	M106
	1000B-5002F	1CT:1CT	T,C	T,C	24-pin SMT	.695/.635/.230	M106
	1000B-5002FX	1CT:1CT	T,C	T,C	24-pin SMT	.695/.635/.230	M106
	1000B-5004	1CT:1CT	T,C,S	T,C,S	24-pin SMT	.705/.490/.190	M428
	1000B-5009	1CT:1CT	T	T	24-pin SMT	.600/.430/.340	M160
	1000B-5009X	1CT:1CT:	T	T	24-pin SMT	.600/.430/.340	M160
	1000B-5010 (PoE)	1CT:1CT	T,C,S	T,C,S	24-pin SMT	.690/.480/.225	M290
	1000B-5010X (PoE)	1CT:1CT	T,C,S	T,C,S	24-pin SMT	.690/.480/.225	M290
	1000B-5012	1CT:1CT	T	T	24-pin SMT	.735/.518/.241	M160
	1000B-5012X	1CT:1CT	T	T	24-pin SMT	.735/.518/.241	M160
	1000B-5016	1CT:1CT	T	T	24-pin SMT	.600/.405/.163	M160
	1000B-5017	1CT:1CT	T,C	T,C	24-pin SMT	.715/.480/.260	M429
	1000B-5017F	1CT:1CT	T,C	T,C	24-pin SMT	.715/.480/.260	M429
	1000B-5026F	1CT:1CT	T,C	T,C	24-pin SMT	.705/.480/.180	M430
	1000B-5027 (PoE)	1CT:1CT	T,C,S	T,C,S	24-pin SMT	.695/.480/.180	M238
	1000B-5027X (PoE)	1CT:1CT	T,C,S	T,C,S	24-pin SMT	.695/.480/.180	M238
	1000B-5028X	1CT:1CT	T	T	24-pin SMT	.600/.300/.163	M431
	1000B-5028FX	1CT:1CT	T	T	24-pin SMT	.600/.300/.163	M431
	1000B-5029	1CT:1CT	T,C	T,C	24-pin SMT	.700/.620/.185	M285
	1000B-5029X	1CT:1CT	T,C	T,C	24-pin SMT	.700/.620/.185	M285
	1000B-5033	1CT:1CT	T,C	T,C	24-pin SMT	.600/.430/.340	M433
	1000B-5033X	1CT:1CT	T,C	T,C	24-pin SMT	.600/.430/.340	M433
	1000B-5035	1CT:1CT	T,C,S	T,C,S	24-pin SMT	.736/.537/.225	M434
	1000B-5036 (PoE)	1CT:1CT	T,C	T,C	24-pin SMT	.725/.490/.265	M435
	1000B-5037 (PoE)	1CT:1CT	T,C	T,C	24-pin SMT	.725/.633/.410	M436
	1000B-5042	1CT:1CT	T,C	T,C	24-pin SMT	.510/.520/.155	M437
	1000B-5045X	1CT:1CT	T,C	T,C	24-pin SMT	.725/.490/.265	M438
	1000B-5046X	1CT:1CT	T,C	T,C	24-pin SMT	.725/.490/.265	M439
10GB-6001	1CT:1CT	T,C	T,C	24-pin SMT	.700/.630/.235	M375	
10GB-6006	1CT:1CT	T,C	T,C	24-pin SMT	.700/.630/.235	M555	
10GB-6007	1CT:1CT	T,C	T,C	24-pin SMT	.790/.760/.100	M553	
10GB-6009	1CT:1CT	T,C	T,C	30-pin SMT	.705/.615/.295	M562	
Dual	1000B-5003	1CT:1CT	T,C	T,C	50-pin SMT	1.100/.430/.340	M106
	1000B-5003X	1CT:1CT	T,C	T,C	50-pin SMT	1.100/.430/.340	M106
	1000B-5003F	1CT:1CT	T,C	T,C	50-pin SMT	1.100/.430/.340	M106
	1000B-5003FX	1CT:1CT	T,C	T,C	50-pin SMT	1.100/.430/.340	M106
	1000B-5014	1CT:1CT	T,C,S	T,C,S	48-pin SMT	1.100/.610/.290	M160
	1000B-5014X	1CT:1CT	T,C,S	T,C,S	48-pin SMT	1.100/.610/.290	M160
	1000B-5020	1CT:1CT	T,C	T,C	48-pin SMT	.100/.610/.290	M286
	1000B-5020X	1CT:1CT	T,C	T,C	48-pin SMT	.100/.610/.290	M286

- View stock and download literature on the web at <http://www.inrcore.com> - On the Home page, "Search by Part Number"
- iNRCORE's standard lead finish is tin/lead (Sn63/Pb37). Parts can be ordered Non-Lead by adding "NL" to the part number (i.e. 1000B-5003NL).
- To order in Tape & Reel packaging, add the suffix "T" to the part number (i.e. 1000B-5002FXT)
- T = Transformer, C = Choke, S = Shunt inductor
- Standard Operating Temperature: -40°C to +85°C
- Extended Operating Temperature (suffix "X"): -55°C to +125°C
- Parts compliant to IEEE 802.3 standard
- **PoE** = Power of Ethernet Per IEEE 802.3af, 15 W



INRCORE ETHERNET/AFDX

High Isolation Ethernet

Part Number	Insertion Loss (dB MAX)				Return Loss (dB MIN)						Crosstalk (dB MIN)				Differential to Common Mode Rejection (dB MIN)				Isolation	Data Sheet
	0.1 - 30 MHz	60 MHz	80 MHz	100 MHz	5 MHz	30 MHz	50 MHz	60 MHz	80 MHz	100 MHz	1 MHz	30 MHz	60 MHz	100 MHz	30 MHz	60 MHz	100 MHz	200 MHz		
X-1644	-1	-2	-2.5	-4	-18	-9	-5.5	-4.5	-3.0	-2.0	-45	-30	-27	-25	-36	-32	-30	-25	10K VAC	M215
X-1697	-1.5	-3	-3.5	-4.5	-18	-8	-5.5	-4.5	-3.3	-2	-45	-30	-27	-25	-36	-32	-30	-25	10K VAC	M514
100B-1014	-1.1	-1	/	-1.4	-20	-13	-10	-9	-7	/	-50	-40	-40	-35	-42	-37	-35	-35	6K VAC	M510
100B-1021	-1	-2	-3	-4	-18	-9	-5.5	-4.5	-3	-2	-45	-30	-27	-25	-36	-32	-30	-25	8K VAC	M511
100B-1044	-1	-1	-1	-1	-12	-12	-12	-12	-10	-8	-45	-30	-27	-25	-36	-32	-30	-25	6K VAC	M512

- View stock and download literature on the web at <http://www.inrcore.com> - On the Home page, "Search by Part Number"
- INRCORE's standard lead finish is tin/lead (Sn63/Pb37). Parts can be ordered Non-Lead by adding "NL" to the part number (i.e. 100B-1014NL).
- To order in Tape & Reel packaging, add the suffix "T" to the part number (i.e. 100B-1014T)

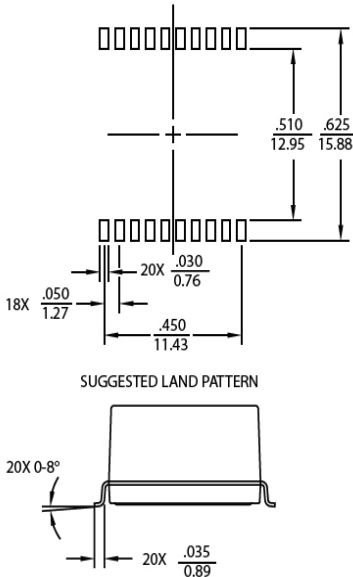
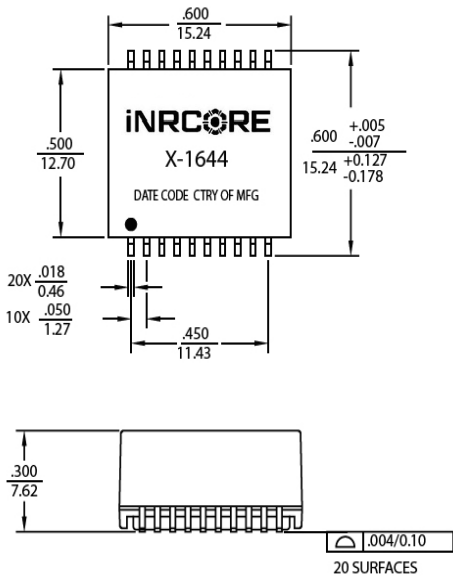

Weight 2.6 grams
 Tube 20/tube
 Tape & Reel 300/reel

Dimensions: Inches
 mm
 Unless otherwise specified, all tolerances are ± .010
 0,25

MIL-STD-1553 INTERFACE TRANSFORMERS

Non-QPL

Part Number*	Turns Ratio (±3%)	Impedance (W MIN)	Package L/W/H (in.)	Data Sheet	Part Number*	Turns Ratio (±3%)	Impedance (W MIN)	Package L/W/H (in.)	Data Sheet
FL1553-1	1CT:1CT/1CT.:707CT	4,000	.630/.630/.155	M227	STQ1553-3	1.25CT:1CT/1.66CT:1CT	4,000	.630/.630/.340	M230
GL1553-1	1CT:1CT/1CT.:707CT	4,000	.630/.630/.155	M227	STQ1553-5	1CT:2.12CT/1CT:1.5CT	4,000	.630/.630/.340	M230
TL1553-1	1CT:1CT/1CT.:707CT	4,000	.630/.630/.155	M226	STQ1553-45	1.5CT/1CT:1.79CT	4,000	.630/.630/.340	M230
FL1553-2	1.4CT:1CT/2CT:1CT	7,200	.630/.630/.155	M227	SFQ1553-1	1CT:1CT/1CT.:707CT	4,000	.630/.630/.340	M231
GL1553-2	1.4CT:1CT/2CT:1CT	7,200	.630/.630/.155	M227	SGQ1553-1	CT:1CT/1CT.:707CT	4,000	.630/.630/.340	M231
TL1553-2	1.4CT:1CT/2CT:1CT	7,200	.630/.630/.155	M226	SFQ1553-2	1.4CT:1CT/2CT:1CT	7,200	.630/.630/.340	M231
FL1553-3	1.25CT:1CT/1.66CT:1CT	4,000	.630/.630/.155	M227	SGQ1553-2	1.4CT:1CT/2CT:1CT	7,200	.630/.630/.340	M231
GL1553-3	1.25CT:1CT/1.66CT:1CT	4,000	.630/.630/.155	M227	SFQ1553-3	1.25CT:1CT/1.66CT:1CT	4,000	.630/.630/.340	M231
TL1553-3	1.25CT:1CT/1.66CT:1CT	4,000	.630/.630/.155	M226	SGQ1553-3	1.25CT:1CT/1.66CT:1CT	4,000	.630/.630/.340	M231
TL1553-5	1CT:2.12CT/1CT:1.5CT	4,000	.630/.630/.155	M227	SFQ1553-5	1CT:2.12CT/1CT:1.5CT	4,000	.630/.630/.340	M231
GL1553-5	1CT:2.12CT/1CT:1.5CT	4,000	.630/.630/.155	M227	SGQ1553-5	1CT:2.12CT/1CT:1.5CT	4,000	.630/.630/.340	M231
TL1553-5	1CT:2.12CT/1CT:1.5CT	4,000	.630/.630/.155	M226	SFQ1553-45	1CT:2.5CT/1CT:1.79CT	4,000	.630/.630/.340	M231
FL1553-45	1CT:2.5CT/1CT:1.79CT	4,000	.630/.630/.155	M227	SGQ1553-45	1CT:2.5CT/1CT:1.79CT	4,000	.630/.630/.340	M231
GL1553-45	1CT:2.5CT/1CT:1.79CT	4,000	.630/.630/.155	M227	SLQF1553-1	1CT:1CT/1.4CT:1CT	4000	.630/.630/.280	M234
TL1553-45	1CT:2.5CT/1CT:1.79CT	4,000	.630/.630/.155	M226	SLQF1553-2	1.4CT:1CT/2CT:1CT	7,200	.630/.630/.280	M234
DFL1553-1	1CT:1CT/1CT.:707CT	4,000	.930/.630/.155	M229	SLQF1553-3	1.25CT:1CT/1.66CT:1CT	4,000	.630/.630/.280	M234
DGL1553-1	1CT:1CT/1CT.:707CT	4,000	.930/.630/.155	M229	SLQF1553-5	1CT:2.12CT/1CT:1.5CT	4,000	.630/.630/.280	M234
DTL1553-1	1CT:1CT/1CT.:707CT	4,000	.930/.630/.155	M228	SLQF1553-45	1CT:2.5CT/1CT:1.79CT	4,000	.630/.630/.280	M234
DFL1553-2	1.4CT:1CT/2CT:1CT	7,200	.930/.630/.155	M229	SLQG1553-1	1CT:1CT/1.4CT:1CT	4,000	.630/.630/.280	M234
DGL1553-2	1.4CT:1CT/2CT:1CT	7,200	.930/.630/.155	M229	SLQG1553-2	1.4CT:1CT/2CT:1CT	7,200	.630/.630/.280	M234
DTL1553-2	1.4CT:1CT/2CT:1CT	7,200	.930/.630/.155	M228	SLQG1553-3	1.25CT:1CT/1.66CT:1CT	4,000	.630/.630/.280	M234
DFL1553-3	1.25CT:1CT/1.66CT:1CT	4,000	.930/.630/.155	M229	SLQG1553-5	1CT:2.12CT/1CT:1.5CT	4,000	.630/.630/.280	M234
DGL1553-3	1.25CT:1CT/1.66CT:1CT	4,000	.930/.630/.155	M229	SLQG1553-45	1CT:2.5CT/1CT:1.79CT	4,000	.630/.630/.280	M234
DTL1553-3	1.25CT:1CT/1.66CT:1CT	4,000	.930/.630/.155	M228	SLQT1553-1	1CT:1CT/1.4CT:1CT	4,000	.630/.630/.280	M234
DFL1553-5	1CT:2.12CT/1CT:1.5CT	4,000	.930/.630/.155	M229	SLQT1553-2	1.4CT:1CT/2CT:1CT	7,200	.630/.630/.280	M234
DGL1553-5	1CT:2.12CT/1CT:1.5CT	4,000	.930/.630/.155	M229	SLQT1553-3	1.25CT:1CT/1.66CT:1CT	4,000	.630/.630/.280	M234
DTL1553-5	1CT:2.12CT/1CT:1.5CT	4,000	.930/.630/.155	M228	SLQT1553-5	1CT:2.12CT/1CT:1.5CT	4,000	.630/.630/.280	M234
DFL1553-45	1CT:2.5CT/1CT:1.79CT	4,000	.930/.630/.155	M229	SLQT1553-45	1CT:2.5CT/1CT:1.79CT	4,000	.630/.630/.280	M234
DGL1553-45	1CT:2.5CT/1CT:1.79CT	4,000	.930/.630/.155	M229	X-1584	1CT:1.79CT	3,000	.500/.350/.172	M157
DTL1553-45	1CT:2.5CT/1CT:1.79CT	4,000	.930/.630/.155	M228	X-1596	v1CT:2.5CT	3,000	.500/.350/.172	M157
STQ1553-1	1CT:1CT/1CT.:707CT	4,000	.630/.630/.340	M230	Q1553-71**	1CT:3CT/1CT:2.15CT	4,000	.625/.625/.250	M128
STQ1553-2	1.4CT:1CT/2CT:1CT	7,200	.630/.630/.340	M230	SMQ1553-70**	1CT:3CT/1CT:2.15CT	4,000	.625/.625/.250	M128

***Choose 1 of 3 Operating Temperature Ranges :**

Operating Temperature	Flat Pack Prefix	Gull Wing Prefix	Through-Hole Prefix
0° to +70°C	FLC	GLC	TLC
-40° to +85°C	FLN	GLN	TLN
-55° to +125°C	FL	GL	TL

Part Number Prefix - Package Types

FL	Flat Pack Package
GL	Gull Wing Package
TL	Through-Hole Package
DFL	Dual-Ratio, Dual Interface, Flat Pack Package
DGL	Dual-Ratio, Dual Interface, Gull Wing Package
DTL	Dual-Ratio, Dual Interface, Through-Hole Package
SFQ	Stacked Dual-Ratio, Dual Interface, Flat Pack Package
SGQ	Stacked Dual-Ratio, Dual Interface, Gull Wing Package
STQ	Stacked Dual-Ratio, Dual Interface, Through-Hole Package
SLQF	Stacked/Low Profile, Dual-Ratio, Dual Interface, Flat Pack Package
SLQG	Stacked/Low Profile, Dual-Ratio, Dual Interface, Gull Wing Package
SLQT	Stacked/Low Profile, Dual-Ratio, Dual Interface, Through-Hole Package

- Designed and built to conform to MIL-PRF-21038/27 requirements.
 - **Custom capabilities are available** - See Temperature Range Options
 - Parts can be built and screened to Space NASA EEE-INST-002 requirements.
- ** For use with 3.3VDC Transceivers

Flat Pack



Gull Wing



Through-Hole



MIL-STD-1553 INTERFACE TRANSFORMERS (continued)

Interface Transformers — COTS Series				
Part * Number	Turns Ratio (±3%)	Impedance (W MIN)	Package L/W/H in.	Data Sheet
(X)1553-1	1CT:1CT/1CT:707CT	4,000	.625/.625/.250	M233
(X)1553-2	1.4CT:1CT/2CT:1CT	7,200	.625/.625/.250	M233
(X)1553-3	1.25CT:1CT/1.66CT:1CT	4,000	.625/.625/.250	M233
(X)1553-5	1CT:2.12CT/1.5CT:1CT	4,000	.625/.625/.250	M233
(X)1553-45	1CT:2.5CT/1CT:1.79CT	4,000	.625/.625/.250	M233

- Designed and built to conform to MIL-PRF-21038/27
- To purchase, select desired operating temp. range and add prefix listed below

*Choose 1 of 3 Operating Temperature Ranges

Part Number Prefix	Operating Temperature
C	0° to 70°C
N	-40° to +85°C
TQ	-55° to +125°C

Single Interface Transformers — COTS Low Profile Miniature Series				
Part Number	Turns Ratio (±3%)	Impedance (W MIN)	Package (L/W/H) in.	Data Sheet
SMG1553-60	1.25CT:1CT	4,000	.400/.400/.185	M112
SMG1553-61	1.66CT:1CT	4,000	.400/.400/.185	M112
SMG1553-65	1CT:2.5CT	4,000	.400/.400/.185	M112
SMG1553-66	1CT:1.79CT	4,000	.400/.400/.185	M112
SMG1553-67	1CT:2.7CT	4,000	.400/.400/.185	M112
SMG1553-68	1CT:3.75CT	4,000	.400/.400/.185	M112

- Designed and built to conform to MIL-PRF-21038/27

Dual Interface Transformers — COTS Low Profile Miniature Series				
Part Number	Turns Ratio (±3%)	Impedance (W MIN)	Package (L/W/H) in.	Data Sheet
DKG1553-45	1CT:2.50CT/1CT:1.79CT	4,000	.675/.400/.185	M322
DKG1553-70	1CT:3.00CT/1CT:2.15CT	4,000	.675/.400/.185	M322
DKG1553-71	1CT:3.54CT/1CT:2.70CT	4,000	.675/.400/.185	M222
DKG1553-72	1CT:2.65CT/1CT:2.07CT	4,000	.675/.400/.185	M322
DKG1553-75	1CT:2.50CT/1CT:1.79CT	4,000	.675/.400/.185	M322

- Designed and built to conform to MIL-PRF-21038/27

QPL Series — Qualified to MIL-PRF-21038/27					
Part ** Number	Military Designation Number	Turns Ratio (±3%)	Impedance (W MIN)	Package L/W/H (in.)	Data Sheet
Q(X)1553-20	M21038/27-05	1:1.41	3,000	.500/.350/.250	M223
Q(X)1553-21	M21038/27-06	1CT:1CT	3,000	.500/.350/.250	M223
Q(X)1553-22	M21038/27-07	1CT:1.41CT	3,000	.500/.350/.250	M223
Q(X)1553-23	M21038/27-08	1CT:1.66CT	3,000	.500/.350/.250	M223
Q(X)1553-24	M21038/27-09	1CT:2CT	3,000	.500/.350/.250	M223
Q(X)1553-25	M21038/27-28	1CT:1.5CT	3,000	.500/.350/.250	M223
Q(X)1553-51	M21038/27-29	1CT:1.79CT	3,000	.500/.350/.250	M223
Q(X)1553-52	M21038/27-30	1CT:2.5CT	3,000	.500/.350/.250	M223
Q(X)1553-1	M21038/27-01	1CT:1CT/1CT:707CT	4,000	.625/.625/.250	M224
Q(X)1553-2	M21038/27-02	1.4CT:1CT/2CT:1CT	7,200	.625/.625/.250	M224
Q(X)1553-3	M21038/27-03	1.25CT:1CT/1.66CT:1CT	4,000	.625/.625/.250	M224
Q(X)1553-5	M21038/27-10	1CT:2.12CT/1CT:1.5CT	4,000	.625/.625/.250	M224
Q(X)1553-45	M21038/27-26	1CT:2.5CT/1CT:1.79CT	4,000	.625/.625/.250	M224
Q(X)1553-81	M21038/27-21	1CT:1CT/1CT:707CT	4,000	.625/.625/.275	M224
Q(X)1553-82	M21038/27-22	1.4CT:1CT/2CT:1CT	7,200	.625/.625/.275	M224
Q(X)1553-83	M21038/27-23	1.25CT:1CT/1.66CT:1CT	4,000	.625/.625/.275	M224
Q(X)1553-84	M21038/27-24	1CT:2.12CT/1CT:1.5CT	4,000	.625/.625/.275	M224
Q(X)1553-85	M21038/27-25	1CT:2.5CT/1CT:1.79CT	4,000	.625/.625/.275	M224
FPQ(X)1553-6	M21038/27-16	1CT:1CT/1CT:707CT	4,000	.625/.625/.250	M225
SMQ(X)1553-6	M21038/27-11	1CT:1CT/1CT:707CT	4,000	.625/.625/.250	M225
FPQ(X)1553-7	M21038/27-17	1.4CT:1CT/2CT:1CT	7,200	.625/.625/.250	M225
SMQ(X)1553-7	M21038/27-12	1.4CT:1CT/2CT:1CT	7,200	.625/.625/.250	M225
FPQ(X)1553-8	M21038/27-18	1.25CT:1CT/1.66CT:1CT	4,000	.625/.625/.250	M225
SMQ(X)1553-8	M21038/27-13	1.25CT:1CT/1.66CT:1CT	4,000	.625/.625/.250	M225
FPQ(X)1553-10	M21038/27-20	1CT:2.12CT/1CT:1.5CT	4,000	.625/.625/.250	M225
SMQ(X)1553-10	M21038/27-15	1CT:2.12CT/1CT:1.5CT	4,000	.625/.625/.250	M225
FPQ(X)1553-45	M21038/27-31	1CT:2.5CT/1CT:1.79CT	4,000	.625/.625/.250	M225
SMQ(X)1553-45	M21038/27-27	1CT:2.5CT/1CT:1.79CT	4,000	.625/.625/.250	M225

- Designed and built to conform to MIL-PRF-21038/27
- To purchase, select desired Product Level and choose corresponding Part Number

** Choose 1 of 3 Product Levels

Part Number Variation	Product Level
Q1553-20 <small>(No Variation)</small>	Level M: for general purpose military applications
QC1553-20	Level C: for high reliability commercial/industrial applications
QT1553-20	Level T: for high reliability critical military applications

- Each Product Level utilizes a different degree of Inspection, Sampling, and Testing. **For specific information, please view the Data Sheets listed in table above.**
- View stock and download literature on the web at <http://www.inrcore.com> - On the Home page, "Search by Part Number"
- To order in Tape & Reel packaging, add the suffix "T" to the part number (i.e. Q1553-20T)

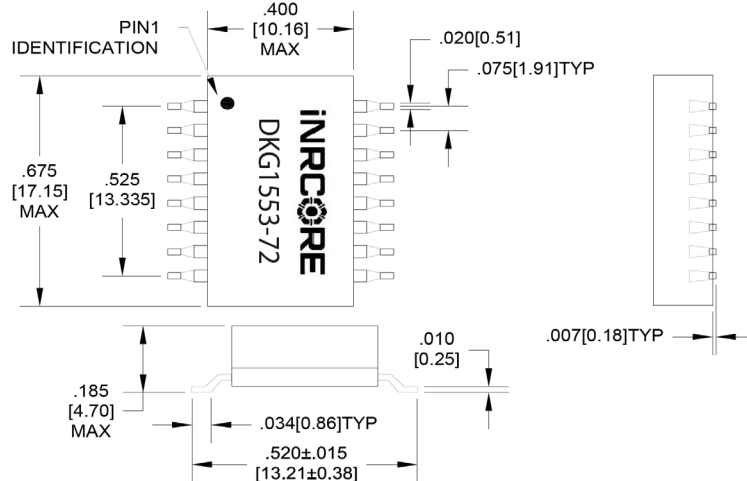

GENERAL PURPOSE PULSE TRANSFORMERS							
TRANSFORMERS							
Part Number	Turns Ratio (1,5): (6,2) ±2%	Primary Inductance (1-5) (mH MIN)	DCR (1-5,6-2) (W MAX)	ET (V-us Min)	Insulation Resistance @250Vdc	Leakage Inductance (µH Max)	Datasheet
IZUHD	1CT:1CT	5.0	1.25	20	10KMohm	2.25	M480
IZUHE	1CT:1CT	3.0	1.25	10	10KMohm	2.70	M481

LOW-SPEED DATA TRANSFORMERS							
T1/E1/CEPT/ISDN-PRI SMT TRANSFORMERS							
Part Number	Turns Ratio Pri: Sec: ±2%	OCL Pri (mH MIN)	C _{ww} (pf MAX)	DCR Pri (W MAX)	Primary Pins	Package L/W/H (in.)	Datasheet
X-1707	1CT:1CT	1.0	25	0.8	1-3	.360/.405/.270	M487
PL1374	1CT:1CT	1.2	35	0.8	1-3	.300/.275/.250	M119
X-1688	1CT:1CT	1.2	35	0.8	1-3	.300/.275/.275	M486

LOW-SPEED DATA TRANSFORMERS							
64kbps ISOLATION TRANSFORMERS							
Part Number	Turns Ratio Pri: Sec: ±2%	Primary Inductance (µH MIN)	Leakage Inductance (µH MAX)	DCR Pri (W MAX)	Inter-winding Capacitance	Package L/W/H (in.)	Datasheet
X-1703	2:1	1.0mH	24	3.00	36	.940/.775/.810	M489
X-1709	1:2CT	20mH	5.0	2.65	130	.448/.335/.400	M483

HIGH-SPEED DATA TRANSFORMERS							
FIBRE CHANNEL ISOLATION							
Part Number	Turns Ratio Pri: Sec: ±2%	Primary Inductance (µH MIN)	C _{ww} (pf MAX)	DCR Pri (W MAX)	Hi-Pot (Vrms MIN)	Package L/W/H (in.)	Datasheet
X-1704	1:1	7.5	5.0	.20	2000	.500/.270/.200	M482
X-1710	1:1	15.0	5.0	.20	150	.495/.280/.200	M485

CAN BUS (COMMON MODE CHOKES)							
80 VDC- 500Vrms							
Part Number	Turns Ratio Pri: Sec: ±2%	Inductance (100kHz) (µH +50%-30%)	Leakage Inductance (µH MAX)	DCR Resatitnce (W MAX)	Current Rating (mADC)	Package L/W/H (in.)	Datasheet
X-1711	1:1	11	.16	.12	800	.310/.260/.250	M488
X-1712	1:1	25	.24	.12	800	.310/.260/.250	M488
X-1713	1:1	51	.22	.20	800	.310/.260/.250	M488
X-1714	1:1	100	.16	.24	800	.310/.260/.250	M488
X-1715	1:1	471	.27	.30	700	.310/.260/.250	M488
X-1716	1:1	1000	.43	.40	700	.310/.260/.250	M488

- View stock and download literature on the web at <http://www.inrcore.com> - On the Home page, "Search by Part Number"
- INRCORE's standard lead finish is tin/lead (Sn63/Pb37). Parts can be ordered Non-Lead by adding "NL" to the part number (i.e. X-1704NL).
- To order in Tape & Reel packaging, add the suffix "T" to the part number (i.e. X-1709T)

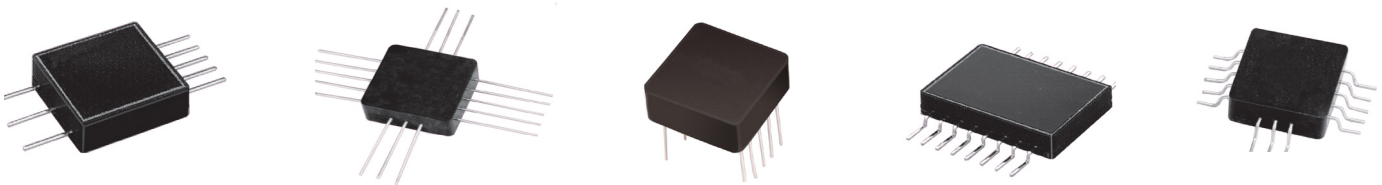

iNRCORE offers custom and catalog power magnetics ruggedized for Military, MIL-PRF-27, MIL-STD-981 and high reliability applications. iNRCORE has a full line of "Off-the-Shelf" inductors for military and aerospace power applications in SLED, SLIC and POGO series packaging. The SLED, SLIC and POGO series use ruggedized high temperature headers suitable for surface mounting to Printed Circuit Board assemblies. Cores are securely bonded to the headers allowing parts to meet MIL-PRF-27 environmental requirements.

iNRCORE offers **Shielded Drum Core Inductors** and **High Frequency Planar Transformers** incorporating ruggedized PCB mounting clips that have superior performance in applications with shock and vibration requirements. iNRCORE also offers catalog **Gate Drive Transformers** with high isolation, miniature **Current Sense Transformers**, and **Common Mode Chokes** with ruggedized construction to meet MIL-PRF-27 Grade 6 requirements.

iNRCORE continues to offer tin/lead termination finishes for Military, Space and Aerospace applications requiring the highest reliability. Parts can also be purchased with tin/lead finishes where RoHS and REACH compliance are required. iNRCORE offers complete design support, qualification test services and global AS9100 manufacturing capabilities.



POWER INDUCTORS & CHOKES

Toroid Power Inductors - SLED Series						
Part Number	@ I _{RATED} (μH) TYP	I _{RATED} (A)	DCR (mW MAX)	Inductance @0ADC (μH)TYP	Package L/W/H (in.)	Data Sheet
SLED 20						
PL8100	1.01	3.40	11	1.1	.400/.345/.250	M107
PL8101	6.2	1.40	70	7	.400/.345/.250	M107
PL8102	17.6	1.00	125	22.7	.400/.345/.250	M107
SLED 30						
PL8110	3.8	4.80	17.3	5.2	.625/.525/.400	M107
PL8111	9.4	2.80	43.4	12.3	.625/.525/.400	M107
PL8112	29.7	1.40	166	35.3	.625/.525/.400	M107
PL8113	114	0.94	380	167	.625/.525/.400	M107
SLED 40						
PL8120	2.5	8.00	8.3	3.8	.725/.575/.410	M107
PL8121	5.1	5.40	17.7	7.5	.725/.575/.410	M107
PL8122	16.2	2.70	72	21.9	.725/.575/.410	M107
PL8123	58.1	1.30	290	73	.725/.575/.410	M107
PL8124	192	0.90	560	292	.725/.575/.410	M107
PL8125	383	0.72	862	672	.725/.575/.410	M107
PL8130	4.9	7.80	12.4	7.9	.725/.575/.410	M107
PL8131	9	5.50	28	14	.725/.575/.410	M107
PL8132	29.1	2.70	100	40.5	.725/.575/.410	M107
PL8133	645	0.74	1250	1134	.725/.575/.410	M107
PL8150	0.81	14.30	2.5	1.25	.725/.575/.410	M107
PL8151	1.32	11.50	4.0	2.1	.725/.575/.410	M107
SLED 50						
PL8140	9.3	7.20	18.7	16	.900/.690/.520	M107
PL8141	16.1	5.10	32.0	25.9	.900/.690/.520	M107
PL8142	50	2.60	133	72.9	.900/.690/.520	M107
PL8143	1070	0.71	1700	1950	.900/.690/.520	M107
PL8160	1.68	13.90	3.6	2.8	.900/.690/.520	M107
PL8161	2.5	11.40	5.4	4.2	.900/.690/.520	M107
PL8170	3.5	12.40	6.6	6.5	.900/.690/.520	M107
PL8171	4.7	10.40	8.3	8.4	.900/.690/.520	M107
SLED 60						
PL8180	5.2	15.40	5.27	10.5	1.275/1.065/.510	M107
PL8181	9.4	10.90	10.5	17.6	1.275/1.065/.510	M107

SMT Common Mode Chokes: SLIC Series					
Part Number	Inductance (mH ±35%)	I _{RATED} (A)	DCR (mW MAX)	Package L/W/H (in.)	Data Sheet
SLIC Series					
PL8200	0.47	14.0	8	1.220/1.000/500	M108
PL8201	0.63	11.6	10	1.220/1.000/500	M108
PL8202	0.81	9.70	14	1.220/1.000/500	M108
PL8203	0.53	7.20	15	1.110/1.00/395	M108
PL8204	0.59	5.60	21	.770/.670/.390	M108
PL8205	0.77	4.70	40	.770/.670/.390	M108
PL8206	0.22	3.30	60	.770/.670/.390	M108
PL8207	1.32	3.30	60	.770/.670/.390	M108
PL8208	1.47	2.80	80	.770/.670/.390	M108
PL8209	0.88	1.63	110	.500/.500/.215	M108
PL8210	1.17	1.22	200	.500/.500/.215	M108
PL8211	10.15	1.40	210	.770/.670/.395	M108
PL8212	1.125	1.80	55	.500/.519/.200	M108
PL8213	0.80	3.00	27	.511/.511/.338	M108
PL8214	.383	3.3	18	.511/.511/.220	M108
PL8215	.536	3.8	17.1	.645/.560/.350	M108
PL8216	.280	4.0	13.2	.511/.511/.220	M108
PL8217	.486	4.2	16.0	.716/.590/.299	M108
PL8218	.130	5.0	6.75	.519/.519/.220	M108
PL8219	.096	6.0	4.30	.519/.519/.200	M108
PL8220	.400	6.0	9.4	.716/.590/.393	M108
PL8221	.061	7.0	2.9	.531/.531/.220	M108
PL8222	4.84	8.0	7.7	.770/.670/.395	M108
PL8223	1.22	9.0	9.75	1.22/1.00/500	M108
PL8224	.215	10	3.75	.830/.751/.441	M108
PL8225	.095	12.5	3.0	.770/.670/.395	M108
PL8226	.117	14	1.9	.830/.751/.441	M108
PL8227	.500	16	4.25	1.22/1.00/500	M108
PL8228	.380	20	4.1	1.22/1.00/500	M108

- View stock and download literature on the web at <http://www.incore.com> - On the Home page, "Search by Part Number"
- iNRCORE's standard lead finish is tin/lead (Sn63/Pb37). Parts can be ordered Non-Lead by adding "NL" to the part number (i.e. PL8222NL).
- To order in Tape & Reel packaging, add the suffix "T" to the part number (i.e. PL8225T)



POWER INDUCTORS & CHOKES

SMT Power Inductors: SLIC (HCCI-80) Series

Part ¹ Number	Inductance @Irated (μH)	Irated (A)	DCR (mW MAX)	Inductance @0ADC (μH) TYP	Package L/W/H (in.)	Data Sheet
SLIC (HCCI)						
PL8300 ^P	4.52	19	4.8	9.5	1.220/1.000/500	M109
PL8300 ^S	18.1	9.5	19.3	38.0	1.220/1.000/500	M109
PL8301 ^P	3.2	24	3.5	7.2	1.220/1.000/500	M109
PL8301 ^S	12.8	12	13.8	7.2	1.220/1.000/500	M109
PL8302 ^P	2.45	27	2.5	5.1	1.220/1.000/500	M109
PL8302 ^S	9.8	13.5	10.1	20.4	1.220/1.000/500	M109
PL8303 ^P	1.6	34	1.6	3.5	1.220/1.000/500	M109
PL8303 ^S	6.4	17	6.4	13.8	1.220/1.000/500	M109
PL8304 ^P	1.1	38	1.3	2.1	1.220/1.000/500	M109
PL8304 ^S	18.1	9.5	19.3	38.0	1.220/1.000/500	M109

1. Connection: P = Parallel, S = Series

SMT Power Inductors: Toroid, POGO Series

Part ¹ Number	Inductance @Irated (μH)	Irated (A)	DCR (mW MAX)	Inductance @0ADC (μH) TYP	Package L/W/H (in.)	Data Sheet
POGO 40						
PL8400 ^S	43.6	1.1	309	247.2	.725/.575/.310	M111
POGO 50						
PL8401 ^S	21.9	2.7	90.5	72.4	.910/.700/.400	M111
PL8402 ^S	4.025	6.4	23.0	18.4	.910/.700/.400	M111
PL8403 ^P	0.53	23.8	3.0	1.0	.910/.700/.400	M111
PL8404 ^P	1.1	21	2.5	1.7	.910/.700/.400	M111
POGO 60						
PL8405 ^P	2.1	22.4	3.4	2.5	1.280/1.070/.400	M111

1. Connection: P = Parallel, S = Series



SMT Power Inductors: Toroid, SLED Series (contd.)

Part Number	Inductance @Irated (μH)	Irated (A)	DCR (mW MAX)	Inductance @0ADC (μH) TYP	Package L/W/H (in.)	Data Sheet
SLED 25						
PL8500	9.4	3.8	32	10.4	.625/.525/.310	M113
PL8501	13.3	3.2	46	14.6	.625/.525/.310	M113
PL8502	23	2.4	74	25	.625/.525/.310	M113
PL8503	50	1.6	135	56	.625/.525/.310	M113
PL8504	75	1.3	220	83	.625/.525/.310	M113
PL8505	90	1.2	285	100	.625/.525/.310	M113
PL8506	137	1	425	152	.625/.525/.310	M113
PL8507	200	.82	673	220	.625/.525/.310	M113
PL8508	305	.66	972	331	.625/.525/.310	M113
PL8509	439	.56	1520	472	.625/.525/.310	M113

SMT Power Inductors: Toroid, POGO Series (contd.)

Part ¹ Number	Inductance @Irated (μH)	Irated (A)	DCR (mW MAX)	Inductance @0ADC (μH) TYP	Package L/W/H (in.)	Data Sheet
POGO 25						
PL8600 ^P	2.0	8.30	8.0	2.2	.625/.525/.310	M114
PL8600 ^S	7.0	4.16	16.0	8.75	.625/.525/.310	M114
PL8601 ^P	2.4	7.20	10.9	2.6	.625/.525/.310	M114
PL8601 ^S	8.4	3.78	21.8	10.4	.625/.525/.310	M114
PL8602 ^P	5.0	5.20	19.0	5.5	.625/.525/.310	M114
PL8602 ^S	17.9	2.6	38.0	22.45	.625/.525/.310	M114
PL8603 ^P	9.3	3.80	30.0	10.4	.625/.525/.310	M114
PL8603 ^S	33.8	1.89	60	41.7	.625/.525/.310	M114
PL8604 ^P	14.1	3.10	45.5	15.7	.625/.525/.310	M114
PL8604 ^S	50.9	1.54	91	62.8	.625/.525/.310	M114
PL8605 ^P	19.8	2.6	66.5	22.1	.625/.525/.310	M114
PL8605 ^S	29.3	2.20	101	32.8	.625/.525/.310	M114
PL8606 ^P	29.3	2.20	101	32.8	.625/.525/.310	M114
PL8606 ^S	106.1	1.07	202	131.0	.625/.525/.310	M114
PL8607 ^P	42.6	1.80	151	47.6	.625/.525/.310	M114

1. Connection: P = Parallel, S = Series

- View stock and download literature on the web at <http://www.inrcore.com> - On the Home page, "Search by Part Number"
- To order in Tape & Reel packaging, add the suffix "T" to the part number (i.e. PL8400T)
- iNRCORE's standard lead finish is tin/lead (Sn63/Pb37). Parts can be ordered Non-Lead by adding "NL" to the part number (i.e. PL8400NL).
- The rated current as listed is either the saturation current or the heating current

SLED 25

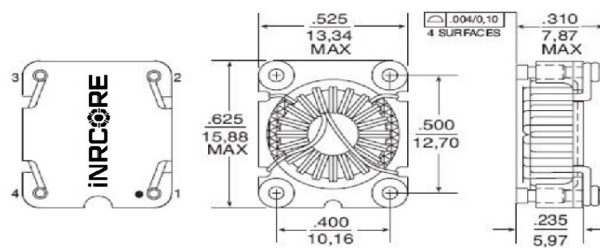
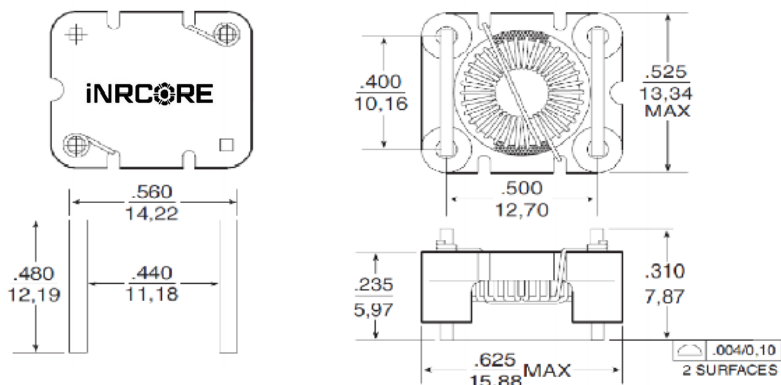

POGO 25



POWER INDUCTORS & CHOKES

SMT Power Inductors: Toroid, POGO Series (contd.)						
Part ¹ Number	Inductance @ I _{RATED} (μH) MIN	I _{RATED} (A)	DCR (mW MAX)	Inductance @0ADC (μH) TYP	Package L/W/H (in.)	Data Sheet
POGO 25						
PL8607 ^S	154.2	0.89	302	190.3	.625/.525/.310	M114
PL8608 ^P	61.3	1.50	222	67.5	.625/.525/.310	M114
PL8608 ^S	218.9	0.74	444	270.2	.625/.525/.310	M114
PL8609 ^P	84.2	1.30	318	91.0	.625/.525/.310	M114
PL8609 ^S	295.0	0.64	636	364.0	.625/.525/.310	M114
POGO 40						
PL8700 ^P	1.5	14.40	4.41	2.2	.725/.575/.380	M115
PL8701 ^P	2.4	9.40	6.54	3.5	.725/.575/.380	M115
PL8702 ^P	4.2	8.10	10.47	5.9	.725/.575/.380	M115
PL8703 ^P	5.8	6.80	14.94	7.9	.725/.575/.380	M115
PL8704 ^P	7.6	5.70	20.99	10.1	.725/.575/.380	M115
PL8705 ^P	12.1	5.20	23.24	18.5	.725/.575/.380	M115
PL8706 ^P	18.0	4.20	38.15	27.4	.725/.575/.380	M115
PL8707 ^P	27.0	3.30	53.21	40.5	.725/.575/.380	M115
PL8708 ^P	34.8	2.30	73.89	50.5	.725/.575/.380	M115
PL8700 ^S	6.1	7.20	17.60	9.0	.725/.575/.380	M115
PL8701 ^S	9.7	5.60	26.20	14.0	.725/.575/.380	M115
PL8702 ^S	17.0	4.10	41.90	23.7	.725/.575/.380	M115
PL8703 ^S	23.1	3.40	59.70	31.5	.725/.575/.380	M115
PL8704 ^S	30.6	2.85	84.00	40.5	.725/.575/.380	M115
PL8705 ^S	48.5	2.70	93.00	74.1	.725/.575/.380	M115
PL8706 ^S	72.0	2.20	152.60	109.8	.725/.575/.380	M115
PL8707 ^S	108.0	1.77	212.80	161.8	.725/.575/.380	M115
PL8708 ^S	139.1	1.50	295.60	202.2	.725/.575/.380	M115

SMT Power Inductors: Shielded Drum Core							
Part Number	Inductance @I _{RATED} (μH TYP)	I _{RATED} (A)	DCR (mW MAX)	Inductance ² @0ADC (μH) TYP	Saturation Current @25°C	Package L/W/H (in.)	Data Sheet
PL8901	0.80	11	4.0	1.0 ²	14	.413/.413/.280	M117
PL8902	1.20	10	6.0	1.5 ²	13	.413/.413/.280	M117
PL8903	2.1	9.0	7.3	2.7 ²	11	.413/.413/.280	M117
PL8904	2.9	8.0	8.5	3.7 ²	9.2	.413/.413/.280	M117
PL8905	3.7	7.3	9.5	4.7 ²	8.2	.413/.413/.280	M117
PL8906	4.8	6.0	16.5	6.0 ²	6.9	.413/.413/.280	M117
PL8907	6	5.5	18.5	7.6 ²	6.2	.413/.413/.280	M117
PL8908	8	5.0	21.8	10	5.5	.413/.413/.280	M117
PL8909	9.6	4.5	29.0	12	5.1	.413/.413/.280	M117
PL8910	12	4.1	35.4	15	4.4	.413/.413/.280	M117
PL8911	14.4	4.0	37.0	18	4.3	.413/.413/.280	M117
PL8912	17.6	3.8	42.0	22	3.8	.413/.413/.280	M117
PL8913	21.6	3.4	45.9	27	3.4	.413/.413/.280	M117
PL8914	26.4	3.0	64.8	33	3.0	.413/.413/.280	M117
PL8915	31.2	2.7	81.5	39	2.8	.413/.413/.280	M117
PL8916	37.6	2.6	89.0	47	2.6	.413/.413/.280	M117
PL8917	54.4	2.1	135.0	68	2.1	.413/.413/.280	M117
PL9101	0.96	10.5	4.5	1.0 ²	12.7	.413/.413/.248	M121
PL9102	1.52	9.5	5.5	1.8 ²	10.1	.413/.413/.248	M121
PL9103	2.34	7.8	7.8	2.7 ²	8.4	.413/.413/.248	M121
PL9104	3.27	6.7	11.0	3.9 ²	7.2	.413/.413/.248	M121
PL9105	4.39	5.6	15.6	5.1 ²	6.3	.413/.413/.248	M121
PL9106	5.54	5.2	18.0	6.8 ²	5.6	.413/.413/.248	M121
PL9107	6.73	5.0	20.0	8.2 ²	5.1	.413/.413/.248	M121
PL9108	8.19	4.6	22	10	4.6	.413/.413/.248	M121
PL9109	9.9	4.2	27	12	4.2	.413/.413/.248	M121
PL9110	13.4	3.6	30	15	3.6	.413/.413/.248	M121
PL9111	15.4	3.4	40	18	3.4	.413/.413/.248	M121
PL9112	17.6	3.2	45	22	3.2	.413/.413/.248	M121
PL9113	22.5	2.8	62	27	2.8	.413/.413/.248	M121
PL9114	28.5	2.5	70	33	2.5	.413/.413/.248	M121
PL9115	31.4	2.4	75	39	2.4	.413/.413/.248	M121
PL9116	38.4	2.2	100	47	2.2	.413/.413/.248	M121
PL9117	48.3	1.9	110	56	1.9	.413/.413/.248	M121
PL9118	55.9	1.8	120	68.0	1.8	.413/.413/.248	M121
PL9119	67.6	1.7	178	82.0	1.7	.413/.413/.248	M121
PL9120	86.1	1.4	230	100.0	1.4	.413/.413/.248	M121
PL9121	103	1.3	253	120.0	1.3	.413/.413/.248	M121
PL9122	121	1.2	280	150.0	1.2	.413/.413/.248	M121
PL9123	149	1.1	310	180.0	1.1	.413/.413/.248	M121
PL9124	186	1.0	400	220.0	1.0	.413/.413/.248	M121
PL9125	224	0.91	460	270	0.91	.413/.413/.248	M121
PL9126	279	0.82	690	330	0.82	.413/.413/.248	M121
PL9127	335	0.72	760	390	0.72	.413/.413/.248	M121
PL9128	398	0.68	850	470	0.68	.413/.413/.248	M121
PL9129	464	0.63	1060	560	0.63	.413/.413/.248	M121
PL9130	563	0.57	1200	680	0.57	.413/.413/.248	M121
PL9131	681	0.52	1550	820	0.52	.413/.413/.248	M121

SMT Common Mode Inductors: Toroid, POGO Series							
Part Number	Inductance (mH ±30%)	I _{rated} (A)	DCR (mW MAX)	SRF (MHz)	Impedance Curve*	Package L/W/H (in.)	Data Sheet
POGO 40							
PL8801	1.5	1.50	60	2	2	.725/.575/.380	M116
PL8803	10.0	1.00	450	0.5	4	.725/.575/.380	M116
PL8804	22.0	0.50	850	0.3	5	.725/.575/.380	M116
POGO 50							
PL8800	1.0	3.60	50	4	1	.910/.700/.510	M116
PL8802	3.0	2.50	80	2.2	3	.910/.700/.510	M116

* Impedance Curves

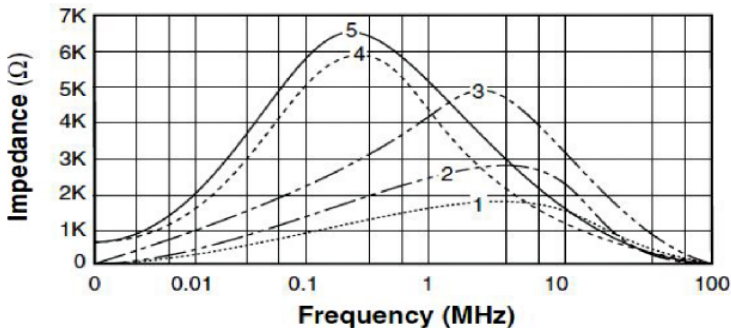

1. Connection: P = Parallel, S = Series
2. Inductance at 0ADC tolerance is ± 30% The tolerance is ± 20% on all other parts.

- View stock and download literature on the web at <http://www.inrcore.com> - On the Home page, "Search by Part Number"
- To order in Tape & Reel packaging, add the suffix "T" to the part number (i.e. PL9123T)
- iNRCORE's standard lead finish is tin/lead (Sn63/Pb37). Parts can be ordered Non-Lead by adding "NL" to the part number (i.e. PL9123NL).

continued on the next page

POWER INDUCTORS (continued)

SMT Power Inductors: Shielded Drum Core (continued)

Part Number	Inductance @Irated (μH TYP)	Irated ¹ (A)	DCR (mW MAX)	Inductance @0ADC (μH) TYP	Saturation Current @25°C	Package L/W/H (in.)	Data Sheet	Part Number	Inductance @Irated (μH TYP)	Irated ¹ (A)	DCR (mW MAX)	Inductance @0ADC (μH) TYP	Saturation Current @25°C	Package L/W/H (in.)	Data Sheet
PL9201	0.95	8.7	5.7	1.0	11	.413/.413/.201	M122	PL9401	0.67	7.00	4.4	0.68	7.00	.410/.410/.132	M123
PL9202	1.55	7.4	7.9	1.6	8.8	.413/.413/.201	M122	PL9402	1.3	6.10	6.4	1.5	6.10	.410/.410/.132	M123
PL9203	2.32	6.6	10.0	2.7	7.3	.413/.413/.201	M122	PL9403	2.1	5.70	10.4	2.2	5.70	.410/.410/.132	M123
PL9204	3.24	5.5	4.5	3.6	6.3	.413/.201/.201	M122	PL9404	3.1	4.80	15.6	3.3	4.80	.410/.410/.132	M123
PL9205	4.26	5.1	16.5	4.5	5.5	.413/.413/.201	M122	PL9405	4.5	4.10	21.2	4.7	4.10	.410/.410/.132	M123
PL9206	5.64	4.4	22	6.0	4.9	.413/.413/.201	M122	PL9406	5.8	3.60	25.2	6.2	3.60	.410/.410/.132	M123
PL9207	7.17	4.2	25	7.6	4.4	.413/.413/.201	M122	PL9407	7.0	3.30	27.8	6.8	3.30	.410/.410/.132	M123
PL9208	9.3	3.6	35	10	4.0	.413/.413/.201	M122	PL9408	9.4	3.00	39.5	8.2	3.00	.410/.410/.132	M123
PL9209	10.8	3.3	37	12	3.7	.413/.413/.201	M122	PL9409	11	2.70	42.9	10	2.70	.410/.410/.132	M123
PL9210	13.4	3.0	47	15	3.4	.413/.413/.201	M122	PL9410	12	2.40	50.0	12	2.40	.410/.410/.132	M123
PL9211	17.5	2.7	58	18	2.9	.413/.413/.201	M122	PL9411	15	2.25	65.2	15	2.25	.410/.410/.132	M123
PL9212	19.4	2.6	67	22	2.8	.413/.413/.201	M122	PL9412	24	1.85	86.1	22	1.85	.410/.410/.132	M123
PL9213	24.2	2.2	79	27	2.4	.413/.413/.201	M122	PL9413	35	1.40	126	33	1.40	.410/.410/.132	M123
PL9214	30.6	2.1	94	33	2.2	.413/.413/.201	M122	PL9414	48	1.25	188	47	1.25	.410/.410/.132	M123
PL9215	38.5	1.8	126	39	2.0	.413/.413/.201	M122	PL9415	55	1.15	208	56	1.15	.410/.410/.132	M123
PL9216	46.1	1.7	140	47	1.8	.413/.413/.201	M122	PL9416	64	1.05	279	68	1.05	.410/.410/.132	M123
PL9217	53.2	1.6	157	56	1.7	.413/.413/.201	M122	PL9417	88	0.94	317	82	0.94	.410/.410/.132	M123
PL9218	63.1	1.45	202	68.0	1.6	.413/.413/.201	M122	PL9418	106	0.88	358	100	0.88	.410/.410/.132	M123
PL9219	76.6	1.36	232	82.0	1.4	.413/.413/.201	M122	PL9419	129	0.80	478	120	0.80	.410/.410/.132	M123
PL9220	88	1.29	270	100.0	1.3	.413/.413/.201	M122	PL9420	157	0.70	545	150	0.70	.410/.410/.132	M123
PL9221	112	1.07	316	120.0	1.2	.413/.413/.201	M122	PL9421	238	0.58	837.0	220	0.58	.410/.410/.132	M123
PL9222	135	1.02	456	150.0	1.05	.413/.413/.201	M122	PL9422	325	0.45	1199	330	0.45	.410/.410/.132	M123
PL9223	132	0.87	497	180.0	0.96	.413/.413/.201	M122	PL9501	2.15	2.60	17.6	2.5	2.6	.256/.256/.122	M124
PL9224	198	0.82	681	220.0	0.86	.413/.413/.201	M122	PL9502	2.58	2.30	20.3	3.3	2.3	.256/.256/.122	M124
PL9225	237	0.78	775	270	0.79	.413/.413/.201	M122	PL9503	3.43	2.10	27.0	4	2.1	.256/.256/.122	M124
PL9226	296	0.66	955	330	0.71	.413/.413/.201	M122	PL9504	4.63	1.85	31.1	5	1.85	.256/.256/.122	M124
PL9227	355	0.58	1087	390	0.66	.413/.413/.201	M122	PL9505	5.22	1.70	41.9	6	1.7	.256/.256/.122	M124
PL9228	445	0.54	1403	470	0.59	.413/.413/.201	M122	PL9506	6.57	1.50	49.9	8	1.5	.256/.256/.122	M124
PL9229	495	0.53	1623	560	0.54	.413/.413/.201	M122	PL9507	8.65	1.30	54.0	10	1.3	.256/.256/.122	M124
PL9230	610	0.49	1824	680	0.49	.413/.413/.201	M122	PL9508	9.78	1.20	72.0	12	1.2	.256/.256/.122	M124
PL9231	702	0.43	2355	820	0.45	.413/.413/.201	M122	PL9509	12.13	1.10	82.0	15	1.1	.256/.256/.122	M124
PL9232	890	0.40	2850	1000	0.41	.413/.413/.201	M122	PL9510	15.23	1.05	102.0	18	1.05	.256/.256/.122	M124
PL9301	0.62	7.60	5.5	0.68	10	.410/.410/.157	M120	PL9511	18.7	0.95	119.0	22	0.95	.256/.256/.122	M124
PL9302	1.2	7.10	7.3	1.3	8	.410/.410/.157	M120	PL9512	21.54	0.85	146.0	27	0.85	.256/.256/.122	M124
PL9303	1.9	5.80	10.9	2.2	6.15	.410/.410/.157	M120	PL9513	27.71	0.76	183.0	33	0.76	.256/.256/.122	M124
PL9304	2.8	5.20	13.3	3.3	5.8	.410/.410/.157	M120	PL9514	33.57	0.68	210.0	39	0.68	.256/.256/.122	M124
PL9305	4.0	4.70	19.6	4.7	5.4	.410/.410/.157	M120	PL9515	40.15	0.60	230.0	47	0.6	.256/.256/.122	M124
PL9306	5.4	3.70	27.0	6.0	4.5	.410/.410/.157	M120	PL9516	49.68	0.55	305.0	56	0.55	.256/.256/.122	M124
PL9307	6.9	3.50	30.8	7.6	4	.410/.410/.157	M120	PL9517	60.66	0.48	351.0	68	0.48	.256/.256/.122	M124
PL9308	8.0	3.40	33.2	10	3.8	.410/.410/.157	M120	PL9518	74.71	0.45	419.0	82	0.45	.256/.256/.122	M124
PL9309	11	3.00	45.2	12	3.4	.410/.410/.157	M120	PL9519	85.39	0.40	520.0	100	0.4	.256/.256/.122	M124
PL9310	12	2.80	49.4	15	3.1	.410/.410/.157	M120								
PL9311	19	2.30	77	22	2.8	.410/.410/.157	M120								
PL9312	25	2.10	89	27	2.3	.410/.410/.157	M120								
PL9313	38	1.65	142	47	2.1	.410/.410/.157	M120								
PL9314	55	1.32	212.0	68	1.5	.410/.410/.157	M120								
PL9315	83	1.10	328	100	1.35	.410/.410/.157	M120								
PL9316	123	0.88	500	150	1.15	.410/.410/.157	M120								
PL9317	178	0.73	739	220	0.92	.410/.410/.157	M120								
PL9318	278	0.60	1133	330	0.7	.410/.410/.157	M120								

- The rated current as listed is either the saturation current or the heating current depending on which value is lower.
- View stock and download literature on the web at <http://www.incore.com> - On the Home page, "Search by Part Number"
 - To order in Tape & Reel packaging, add the suffix "T" to the part number (i.e. PL9515T)
 - iNRCORE's standard lead finish is tin/lead (Sn63/Pb37). Parts can be ordered RoHS compliant by adding the suffix "NL" to the part number (i.e. PL9515NL).

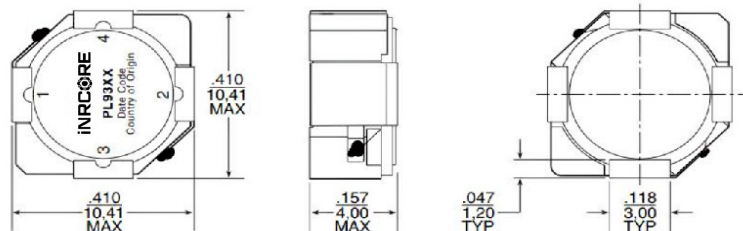

PLANARS POWER INDUCTORS

Electrical Specification @25°C - Operating Temperature -40°C to +130°C

Part Number	Inductance @I _{rated} (μH ± 15%)	I _{rated} ¹ (ADC)	DCR (mW)		Inductance @0ADC (μH ± 15%)	Saturation Current (ADC)		Heating Current (A)	Data Sheet	
			TYP	MAX		25°C	100°C			
2-Turn (Low Loss Series)										
PL10100	0.45	73	0.38	0.48	0.45	95	80	73	M194	
PL10101	0.63	54	0.38	0.48	0.65	63	53	73	M194	
PL10102	0.85	39	0.38	0.48	0.91	46	37	73	M194	
PL10103	1.05	30	0.38	0.48	1.10	35	30	73	M194	
PL10104	1.25	25	0.38	0.48	1.30	29	26	73	M194	
PL10105	1.45	21	0.38	0.48	1.50	24	22	73	M194	
2-Turn Series										
PL10106	0.45	52	0.78	0.98	0.45	95	80	52	M194	
PL10107	0.63	52	0.78	0.98	0.65	63	53	52	M194	
PL10108	0.85	39	0.78	0.98	0.91	46	37	52	M194	
PL10109	1.05	30	0.78	0.98	1.10	35	30	52	M194	
PL10110	1.25	25	0.78	0.98	1.30	29	26	52	M194	
PL10111	1.45	21	0.78	0.98	1.50	24	22	52	M194	
3-Turn Series										
PL10112	0.95	42	1.15	1.43	1.00	68	54	42	M194	
PL10113	1.40	36	1.15	1.43	1.50	43	35	42	M194	
PL10114	1.90	25	1.15	1.43	2.00	29	25	42	M194	
PL10115	2.40	20	1.15	1.43	2.50	23	21	42	M194	
PL10116	2.80	15	1.15	1.43	3.00	18	16	42	M194	
PL10117	3.40	12	1.15	1.43	3.50	15	13	42	M194	
4-Turn Series										
PL10118	1.60	37	1.44	1.80	1.60	55	43	37	M194	
PL10119	2.40	30	1.44	1.80	2.42	35	27	37	M194	
PL10120	3.30	17	1.44	1.80	3.60	20	18	37	M194	
PL10121	4.00	14	1.44	1.80	4.40	16	15	37	M194	
PL10122	4.90	11	1.44	1.80	5.34	13	12	37	M194	
PL10123	5.80	9	1.44	1.80	6.20	11	10	37	M194	

- View stock and download literature on the web at <http://www.inrcore.com> - On the Home page, "Search by Part Number"
- To order in Tape & Reel packaging, add the suffix "T" to the part number (i.e. PL10210T)
- INRCORE's standard lead finish is tin/lead (Sn63/Pb37). Parts can be ordered RoHS compliant by adding the suffix "NL" to the part number (i.e. PL10111NL).



RoHS
Optional



HIGH FREQUENCY PLANAR TRANSFORMERS

Electrical Specification @25°C - Power Rating up to 250W

Part Number	Turns Ratio		Primary Inductance (µH MIN)	Leakage Inductance (µH MIN)	DCR (mΩ MAX)			Data Sheet
	Primary	Secondary			Primary A	Primary B	Secondary	
PL10201	4T & 4T	1T:1T:1T:1T	216	0.3	13	13	4.5	M343
PL10203	5T & 5T	1T:1T:1T:1T	340	0.3	15	15	4.5	M343
PL10205	6T & 6T	1T:1T:1T:1T	480	0.3	21	21	4.5	M343
PL10207	7T & 7T	1T:1T:1T:1T	660	0.3	50	50	4.5	M343
PL10208	4T & 4T	1T & 1T	216	0.3	13	13	4.5	M343
PL10209	8T & 8T	1T:1T:1T:1T	860	0.3	60	60	4.5	M343
PL10210	5T & 5T (w/ 5T aux)	1T & 1T	340	0.3	15	15	0.56 & 0.56	M343
PL10212	6T & 6T (w/2T aux)	1T & 1T	480	0.3	21	21	0.56 & 0.56	M343
PL10214	7T & 7T (w/3T aux)	1T & 1T	660	0.3	50	50	0.56 & 0.56	M343
PL10216	8T & 8T	1T & 1T	860	0.3	60	60	0.56 & 0.56	M343
PL10230	4T	1T:1T:1T:1T	54	0.3	13	-	4.5	M343
PL10231	5T (w/5T aux)	1T:1T:1T:1T	85	0.3	15	470	4.5	M343
PL10232	6T (w/2T aux)	1T:1T:1T:1T	120	0.3	21	156	4.5	M343
PL10233	7T (w/3T aux)	1T:1T:1T:1T	165	0.3	50	200	4.5	M343
PL10234	4T	7T & 7T	54	0.3	13	-	4.5	M343
PL10235	5T (w/5T aux)	7T & 7T	85	0.3	15	470	40 & 40	M343
PL10236	6T (w/2T aux)	7T & 7T	120	0.3	21	156	40 & 40	M343
PL10237	7T (w/3T aux)	7T & 7T	165	0.3	50	200	40 & 40	M343
PL10238	4T	1T & 1T	54	0.3	13	-	40 & 40	M343
PL10239	5T (w/5T aux)	1T & 1T	85	0.3	15	470	40 & 40	M343
PL10240	6T (w/2T aux)	1T & 1T	120	0.3	21	156	1.12 & 1.12	M343
PL10241	7T (w/3T aux)	1T & 1T	165	0.3	50	200	1.12 & 1.12	M343
PL10242	4T	2T & 1T	54	0.3	13	-	1.12 & 1.12	M343
PL10243	5T (w/5T aux)	2T & 1T	85	0.3	15	470	1.12 & 1.12	M343
PL10244	6T (w/2T aux)	2T & 1T	120	0.3	21	156	1.12 & 1.12	M343
PL10245	7T (w/3T aux)	2T & 1T	165	0.3	50	200	1.8 & 0.6	M343
PL10246	8T	1T:1T:1T:1T	215	0.3	60	-	1.8 & 0.6	M343
PL10247	8T	2T & 1T	215	0.3	60	-	1.8 & 0.6	M343
PL10248	8T	1T & 1T	215	0.3	60	-	1.8 & 0.6	M343
PL10249	8T	2T & 1T	215	0.3	60	-	1.8 & 0.6	M343

- View stock and download literature on the web at <http://www.incore.com> - On the Home page, "Search by Part Number"
- To order in Tape & Reel packaging, add the suffix "T" to the part number (i.e. PL10210T)
- INRCORE's standard lead finish is tin/lead (Sn63/Pb37). Parts can be ordered Non-Lead by adding "NL" to the part number (i.e. PL10122NL).

Design Specifications

Design Type	Maximum Height	Part Numbers
Double Interleave Design*	10.2mm	PL10201-16
Single Interleave Design	9.1mm	PL10230-49

*Higher efficiency, lower DCR and lower leakage.

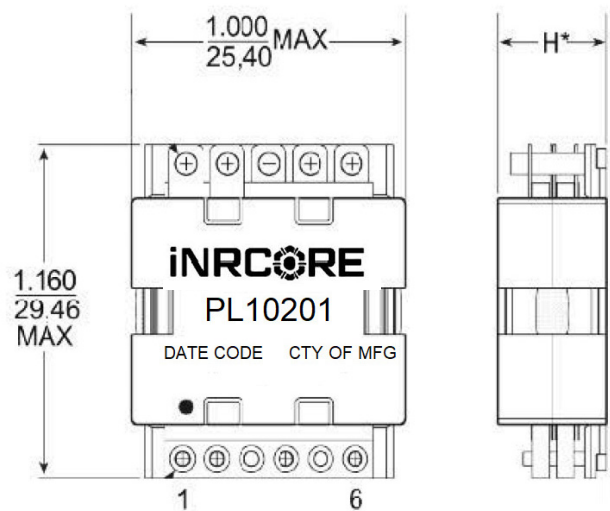

*H - Maximum Height (see table above)

HIGH FREQUENCY PLANAR TRANSFORMERS

Electrical Specification @25°C - Power Rating Up to 140W

Part Number	Turns Ratio		Primary Inductance (µH MIN)	Leakage Inductance (µH MIN)	DCR (mΩ MAX)			Data Sheet
	Primary	Secondary			Primary A	Primary B	Secondary	
PL10301	4T	5T	153	0.45	17.5	17.5	7	M314
PL10302	4T	5T	194	0.45	17.5	20	7	M314
PL10303	5T	5T	240	0.55	20	20	7	M314
PL10304	5T	6T	290	0.60	20	25	7	M314
PL10305	6T	6T	345	0.65	25	25	7	M314
PL10306	4T	4T	153	0.4	7.5	7.5	.875 & .875	M314
PL10307	4T	5T	194	0.4	17.5	20	.875 & .875	M314
PL10308	5T	5T	240	0.5	20	20	.875 & .875	M314
PL10309	5T	6T	290	0.6	20	25	.875 & .875	M314
PL10310	6T	6T	345	0.6	25	25	1.75 & 1.75	M314
PL10311	4T	4T	153	0.4	17.5	17.5	1.75 & 1.75	M314
PL10312	4T	5T	194	0.4	17.5	20	1.75 & 1.75	M314
PL10313	5T	5T	240	0.4	20	20	1.75 & 1.75	M314
PL10314	5T	5T	290	0.5	20	25	1.75 & 1.75	M314
PL10315	6T	6T	345	0.5	25	25	1.75 & 1.75	M314

HIGH FREQUENCY PLANAR TRANSFORMERS

Electrical Specification @25°C - Power Rating Up to 300W

Part Number	Turns Ratio		Primary Inductance (µH MIN)	Leakage Inductance (µH MIN)	DCR (mΩ MAX)			Data Sheet
	Primary	Secondary			Primary A	Primary B	Secondary	
PL10401	4T & 4T	1T:1T:1T:1T	211	0.3	6.8	6.8	4.5	M380
PL10402	5T & 5T	1T:1T:1T:1T	330	0.4	8.5	8.5	4.5	M380
PL10403	6T & 6T	1T:1T:1T:1T	423	0.6	10.2	10.2	4.5	M380
PL10404	7T & 7T	1T:1T:1T:1T	588	0.8	11.8	11.8	4.5	M380
PL10405	4T & 4T	1T:1T:1T:1T	768	1.2	13.4	13.4	4.5	M380
PL10406	8T & 8T	1T & 1T	216	0.45	6.8	6.8	.056 & 0.56	M380
PL10407	5T & 5T	1T & 1T	340	0.84	8.5	8.5	.056 & 0.56	M380
PL10408	6T & 6T	1T & 1T	480	1.0	10.2	10.2	.056 & 0.56	M380
PL10409	7T & 7T	1T & 1T	660	1.2	11.8	11.8	.056 & 0.56	M380
PL10410	8T & 8T	1T & 1T	860	1.7	13.4	3.4	.056 & 0.56	M380

- View stock and download literature on the web at <http://www.inrcore.com> - On the Home page, "Search by Part Number"
- To order in Tape & Reel packaging, add the suffix "T" to the part number (i.e. PL10305T)
- iNRCORE's standard lead finish is tin/lead (Sn63/Pb37). Parts can be ordered Non-Lead by adding "NL" to the part number (i.e. PL10305NL).



SMT CURRENT SENSE TRANSFORMERS

Electrical Specification @25°C - Operating Temperature -55°C to +130°C - Current Rating: 10A

Part Number	Turns Ratio	Current Rating (A)	Secondary Inductance (mH MIN)	DCR (mΩ MAX)		Hipot (Vrms)	Data Sheet
				(8-7)	(1-3)		
PL3250	1:20	10	0.08	6	550	1000	M278
PL3251	1:30	10	0.18	6	870	1000	M278
PL3252	1:40	10	0.32	6	1140	1000	M278
PL3253	1:50	10	0.50	6	1500	1000	M278
PL3254	1:60	10	0.72	6	2250	1000	M278
PL3255	1:70	10	0.98	6	4750	1000	M278
PL3256	1:100	10	2.00	6	5500	1000	M278
PL3257	1:125	10	3.00	6	6500	700	M278

SMT CURRENT SENSE TRANSFORMERS

Electrical Specification @25°C - Operating Temperature -55°C to +130°C - Current Rating: 20A

Part Number	Turns Ratio	Current Rating (A)	Secondary Inductance (mH MIN)	DCR (mΩ MAX)		Hipot (Vrms)	Data Sheet
				(8-7)	(1-3)		
PL2035	1:50	20	0.50	0.75	1500	500	M145
PL2264	1:100	20	2.00	0.75	5500	500	M165
PL3258	1:20	20	0.08	0.75	550	1000	M279
PL3259	1:30	20	0.18	0.75	870	1000	M279
PL3260	1:40	20	0.32	0.75	1140	1000	M279
PL3261	1:50	20	0.50	0.75	1500	1000	M279
PL3262	1:60	20	0.72	0.75	2250	1000	M279
PL3263	1:70	20	0.98	0.75	4750	1000	M279
PL3264	1:100	20	2.00	0.75	5500	1000	M279
PL3265	1:125	20	3.00	0.75	6500	700	M279
PL3479	1:200	20	8.00	0.75	17000	700	M279

SMT CURRENT SENSE TRANSFORMERS

Electrical Specification @25°C - Operating Temperature -55°C to +130°C - Current Rating: 15A

Part Number	Turns Ratio	Current Rating (A)	Secondary Inductance (mH MIN)	DCR (mΩ MAX)		Hipot (Vrms)	Data Sheet
				(1,3-2,4)	(5-6)		
PL1170	1:1:100	15.00	14.8	1.5	930	500	M133
PL1961	1:1:200	15.00	59.2	2.3	4200	500	M150

SMT CURRENT SENSE TRANSFORMERS

Electrical Specification @25°C - Operating Temperature -55°C to +130°C - Current Rating Up to 35A

Part Number	Turns Ratio	Current Rating (A)	Secondary Inductance (mH MIN)	DCR (mΩ MAX)		Hipot (Vrms)	Data Sheet
				(11-12)	(2-4)		
PL1839	50:1	35	1.4	0.42	700	1800	M302
PL1808	100:1	35	5.6	0.42	1400	1800	M302
PL1840	200:1	35	22.4	0.42	2900	1800	M302



APPLICATION CIRCUIT

RoHS
Optional

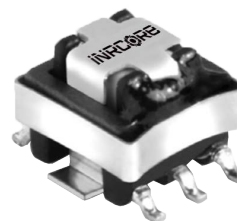

AUDIO TRANSFORMERS

Electrical Specification @25°C - Operating Temperature: -40°C to +130°C

Part Number	Turns Ratio Pri: Sec +/-2%	Primary Impedance (Ω +/-10%)	Insertion Loss (dB MAX) 1KHz/1.0 Vrms	DCR (Ω MAX)		Hipot (Vrms)	Data Sheet
				(2-4)	(7-9)		
PL3141	1.1	600	1.55	55	67	1500	M358
PL3183	1.1	150	1.5	12	14	1250	M508

GATE DRIVE TRANSFORMERS

1000VDC to 1500VDC - Basic & Functional Insulation

Part Number	Turns Ratio	Pri-Sec Insulation	MAX (v*usec) ¹	Primary Inductance (μH MAX)	Leakage Inductance ² (μH MAX)	DCR (Ω MAX)		Package L/W/H (in.)	Insulation	Data Sheet
						Primary	Secondary			
PL3172NL	1:1	1500 Vrms	9.7	1200	0.50	0.91	0.91	.355/.340/.300	FUNCTIONAL	M297
PL1960	1:1	1500VDC	9.7	785	0.46	0.60	0.60	.265/.340/.140	FUNCTIONAL	M149
PL3280	1:1:1	1500Vrms	12.7	800	0.65	0.75	0.75	.340/.265/.140	FUNCTIONAL	M296
X-1569NL	1:1:1	1500VDC	45.1	3330	0.70	1.60	1.60	.355/.340/.300	FUNCTIONAL	M258
X-1622NL	1:1:1	1500Vrms	60.0	1400	1.50	1.60	1.5/1.5	.355/.340/.300	FUNCTIONAL	M295
PL3057NL	2.5:1:1	1500Vrms	27.2	1200	0.80	0.91	.38/.38	.355/.340/.300	BASIC	M294
PL2973	1:1	1500VDC	27.2	1200	0.50	0.91	0.91	.355/.340/.300	BASIC	M299
PL3140	2:1:1	1500Vrms	/	1200	0.60	0.91	0.46	.355/.340/.300	FUNCTIONAL	M383
PL3002	1:1:1	1600Vrms	866	5000	0.50	6	7.2/7.2	0.75/0.75/0.50	FUNCTIONAL	M386
PL2148NL	1:1	1500Vrms	55	1486	0.80	1.15	1.15	.355/.340/.300	FUNCTIONAL	M387
PL3159	1:1:1	2700VDC	21	507	0.40	0.85	0.85/0.85	.315/.200/.118	FUNCTIONAL	M388
PL3212NL	1:1:1	3000Vrms	95	450	0.50	0.08	0.072	.810/.750/.480	BASIC	M389
PL3215NL	1:1:1	6000Vrms	115	686	0.80	0.71	0.71/0.71	.750/.810/.480	BASIC	M394
PL3445NL	1:1:1	1500Vrms	85	7200	2.0	3.0	3/3	.355/.340/.300	FUNCTIONAL	M395
PL3602NL	2:1:1	4000 Vrms	375	1500	8.0	2.2	1.6/1.6	.650/.500/.599	FUNCTIONAL	M396
PL3716	1:1	700Vrms	126	2500	4.0	5.8	6.2	.650/.443/.400	FUNCTIONAL	M392
PL3839NL	1:1:1	2500Vrms	48	1500	TBD	1.5	1.5/1.5	.572/.512/.340	FUNCTIONAL	M393
PL3840	1:1	10KVrms	320	1850	15	0.133	0.12/.085	1.319/1.417/.728	FUNCTIONAL	M397
PL1863	2:1:1	2500VDC	27.2	1200	0.60	0.91	.46/.46	.355/.340/.300	FUNCTIONAL	M398
PL1903	1:1	1500Vrms	15.4	750	0.75	0.88	0.7	.470/.350/.160	BASIC	M410
PL2064	1:2.5:2.5	3750Vrms	10.88	162	0.24	0.28	.56/.56	.665/.421/.267	BASIC	M412
PL2072	1:1	1500Vrms	12	403.2	0.46	0.685	.685	.345/.265/.098	FUNCTIONAL	M367
10B-1002	1:1	700Vrms	24	10,000	30	11	11	.650/.443/.440	FUNCTIONAL	M464

- The maximum volt-μsec rating limits the peak flux density to 2200 Gauss when used in a unipolar drive application. For bi-polar drive applications a maximum volt-μsec of two times this rating is acceptable (ie: 2* (volt*μsec rating) Volt*μsec = (voltage applied to the primary) * dutycycle / Frequency = V * alpha / Freq_Hz = V * μsec
 - Leakage inductance is measured at primary terminals with all secondaries shorted.
- View stock and download literature on the web at <http://www.inrcore.com> - On the Home page, "Search by Part Number"
 - To order in Tape & Reel packaging, add the suffix "T" to the part number (i.e. PL3280T)
 - INRCORE standard lead finish is tin/lead (Sn63/Pb37). Parts can be ordered Non-Lead by adding "NL" to the part number (i.e. PL2973NL).



Space Development/Testing/Validation Capabilities

- MIL-STD-981
 - NASA EEE-INST-002
 - NASA-STD 8739.3
 - IPC-STD-001DS
 - ESA
 - IPC-610
- MIL-PRF-21038
 - MIL-PRF-27
 - MIL-STD-202
 - ECSS-Q-ST-70-38C
 - UL 60601
 - CSA C22.2
- AEC-Q200
 - MIL-STD-883
 - Custom Magnetic Power
 - Signal Design/Build
 - MIL-STD-810
 - IPC/WHMA-A-620

Manufacturing Capabilities

- Bobbin Winding
 - SMT Board Assembly
 - In-House Machine Shop
 - Custom Lead Forming
- Toroid Winding
 - Electrical/Mechanical Assembly
 - Automated Electrical Test
 - E.S.S. Capability
 - Automated Solder Tinning
- AS9100D-Certified Facilities
 - Harness Assembly
 - Transfer Molding
 - Vacuum Encapsulation

Space Program Participation

- ISS
- Orion
- World View III
- MagICE
- HPCA
- James Webb Telescope



Shock and Vibration Testing Table

Real Time 3-D X-Ray Inspection



PRODUCT CAPABILITY	PACKAGING	MAX POWER	MAX CURRENT	FREQUENCY
SINGLE INDUCTORS	Lamination, Toroidal, Tape Wound	4KVA		15 - 2MHz
COMMON MODE CHOKES 1/3 Phase	Lamination, Toroidal, Tape Wound	-	500A	15 - 2400Hz
CHOKES 3 PHASE (LINE FILTERING)	Lamination, Tape Wound	-	500A	15 - 2400Hz
POWER TRANSFORMERS 1 Phase	Lamination, Toroidal, Tape Wound	10KVA	-	15 - 1200Hz
TRANSFORMERS Laminated 3 Phase	Lamination, Toroidal, Tape Wound	10KVA	-	15 - 1200Hz
TRANSFORMERS - Switch Mode	Planar, Bobbin Wound, Toroidal	10KVA	-	20K- 1MHz
INDUCTORS - Switchmode Buck/Boost	Toroidal, Bobbin Wound	500VA	-	20K- 1MHz
TRANSFORMERS - Current Sense	Toroidal, Bobbin Wound	4KVA (burden)	-	15- 1MHz
TRANSFORMER MODULES -Current Sense 1/3 PHASE	Toroidal, Bobbin Wound	4KVA (burden)	-	15- 1MHz
TRANSFORMERS Gate Drive	Toroidal, Bobbin Wound	-	-	20KHz- 1MHz
CURRENT SENSE TRANSFORMERS	Lamination, Toroidal, Tape Wound	10KVA		15 - 1200Hz

Testing Services

Testing capabilities for product qualification and design validation

ELECTRICAL

- Inductance with or without DC
- Turns Ratio
- HI-POT - Vac up to 5kv, Vdc up to 6kV
- Insulation Resistance
- Distortion
- Pulse Testing
- Thermal Rise
- Impedance
- Q (up to 1 Mhz)
- DCR
- SRF (up to 3Ghz)
- Leakage Inductance
- Voltage Ratio

MECHANICAL

- Mechanical Shock
- Mechanical Vibration
- Solderability
- Resistance to Soldering Heat

ENVIRONMENTAL

- Humidity (to 90% RH)
- Moisture Resistance
- Thermal Shock
- Thermal Cycling
- High/Low Temperature Storage
- Steam Aging

ANALYTICAL

- 3D Real Time X-ray
- Plating composition analysis
- Detailed Inspection Plans
- First Article Inspection to AS9102



Inductor Design Worksheet

Contact

Name: _____ Company: _____
E-mail: _____ Phone: _____

Electrical

Common Mode Differential Mode
 PFC Resonant

For PFC inductor only, please specify RMS current at 100-120Hz: _____

And peak to peak current for operation frequency: _____

	Winding 1	Winding 2	Winding 3
Inductance Range:	_____	_____	_____
Rated Current:	_____	_____	_____
Ripple Current:	_____	_____	_____
Q(Quality factor if relevant):	_____	_____	_____
SRF(Self-resonant frequency if relevant) minimum:	_____		

Mechanical

Mounting type:
 Surface mount Through hole
Other: _____
Maximum size:
Length _____ Width _____ Height _____

Safety and environmental requirements

Dielectrical withstanding voltage: _____ DC RMS
Ambient temperature range (°C) : _____
Temperature rise, maximum (°C) : _____
Lead/terminal finish: tin/lead Pure tin
Other: _____

Other

Sample quantity: _____ Date needed: _____
EAU(Estimated annual quantity): _____
Production start date: _____
Budgetary target price (USD) : _____
Specific application for this product: _____
Program name: _____
Restricted/ITAR: Yes No

Power Transformer Design Worksheet

Contact

Name: _____
E-mail: _____

Company: _____
Phone: _____

Electrical

Total output power of power supply: _____

Switching frequency (kHz): _____

Maximum Duty Cycle: _____

Topology

- Flyback Continuous Flyback Discontinuous
 Forward Converter Active clamp forward Two-switch forward
 Push pull Half bridge Full bridge

Other: _____

Primary

Input voltage range: _____

Desired inductance (if known): _____

Turns ratio (if known): _____

Input current (if known): _____

other: _____

Secondary(ies)

	S1	S2	S3	S4	S5	S6
Output voltage:	_____	_____	_____	_____	_____	_____
Output current:	_____	_____	_____	_____	_____	_____
Diode drop:	_____	_____	_____	_____	_____	_____

Mechanical

Mounting type:

- Surface mount Through hole

Other: _____

Maximum size:

Length _____ Width _____ Height _____

Safety and environmental requirements

Agency requirement: IEC _____ UL _____ CSA _____
Insulation class: Functional Basic Supplementary Reinforced

Dielectrical withstanding voltage: _____ DC RMS

Ambient temperature range (°C) : _____

Temperature rise, maximum (°C) : _____

Lead/terminal finish: tin/lead Pure tin

Other: _____

Other

Sample quantity: _____ Date needed: _____

EAU(Estimated annual quantity): _____

Production start date: _____

Budgetary target price (USD) : _____

Specific application for this product: _____

Program name: _____

Restricted/ITAR: Yes No