

Low ESR Cap. Compatible Positive Voltage Regulators

■ GENERAL DESCRIPTION

The XC6206 series are highly precise, low power consumption, 3 terminal, positive voltage regulators manufactured using CMOS and laser trimming technologies. The series provides large currents with a significantly small dropout voltage.

The XC6206 consists of a current limiter circuit, a driver transistor, a precision reference voltage and an error correction circuit. The series is compatible with low ESR ceramic capacitors. The current limiter's foldback circuit operates as a short circuit protection as well as the output current limiter for the output pin.

Output voltages are internally by laser trimming technologies. It is selectable in 0.1V increments within a range of 1.2V to 5.0V. SOT-23, SOT-89 and USP-6B packages are available.

■ APPLICATIONS

- Smart phones / Mobile phones
- Portable game consoles
- Digital still cameras / Camcorders
- Digital audio equipments
- Reference voltage sources
- Multi-function power supplies

■ FEATURES

Maximum Output Current	: 200mA (3.0V type)
Dropout Voltage	: 250mV @ 100mA (3.0V type)
Maximum Operating Voltage	: 6.0V
Output Voltage Range	: 1.2V ~ 5.0V (0.1V increments)
Highly Accurate	: $\pm 2\%$ @ $V_{OUT} \geq 1.5V$ $\pm 30mV$ @ $V_{OUT} < 1.5V$ $(\pm 1\% @ V_{OUT} \geq 2.0V)$
Low Power Consumption	: 1.0 μ A (TYP.)
Low ESR Capacitor	: Ceramic capacitor compatible
Protection	: Current Limit Circuit Built-in
Operating Ambient Temperature	: -40°C ~ 85°C
Packages	: SOT-23 SOT-89 USP-6B
Environmentally Friendly	: EU RoHS Compliant, Pb Free

■ TYPICAL APPLICATION CIRCUIT



■ TYPICAL PERFORMANCE CHARACTERISTICS

XC6206P302

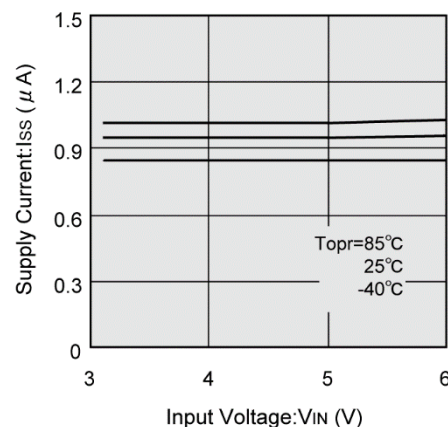

■ BLOCK DIAGRAM



*Diodes inside the circuit are an ESD protection diode and a parasitic diode.

■ PRODUCT CLASSIFICATION

● Ordering Information

XC6206P①②③④⑤-⑥^(*)

DESIGNATOR	ITEM	SYMBOL	DESCRIPTION
①②	Output Voltage	12~50	e.g. V_{OUT} : 3.0V → ①=3, ②=0
③	Accuracy	2	$\pm 2\%$ ($V_{OUT} \geq 1.5V$), $\pm 30mV$ ($V_{OUT} < 1.5V$)
		1	$\pm 1\%$ ($V_{OUT} \geq 2.0V$)
④⑤-⑥	Packages (Order Unit)	MR-G	SOT-23 (3,000pcs/Reel)
		PR-G	SOT-89 (1,000pcs/Reel)
		DR-G	USP-6B (3,000pcs/Reel)

^(*) The "-G" suffix denotes Halogen and Antimony free as well as being fully EU RoHS compliant.

■ PIN CONFIGURATION

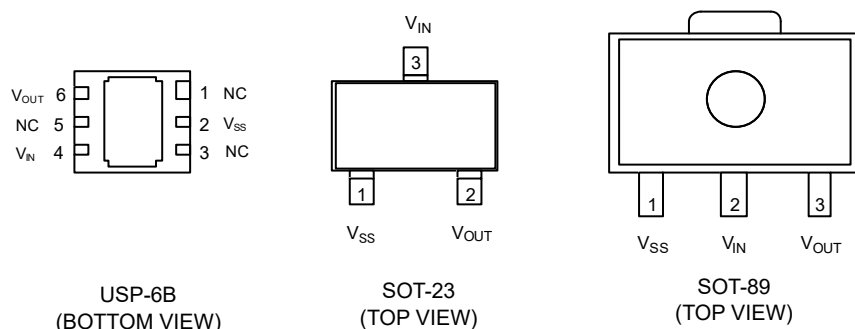

*The dissipation pad for the USP-6B package should be solder-plated in recommended mount pattern and metal masking so as to enhance mounting strength and heat release.
If the pad needs to be connected to other pins, it should be connected to the pin number 4 (V_{IN}).

■ PIN ASSIGNMENT

PIN NUMBER			PIN NAME	FUNCTIONS
SOT-23	SOT-89	USP-6B		
1	1	2	V _{SS}	Ground
3	2	4	V _{IN}	Power Input
2	3	6	V _{OUT}	Output
-	-	1, 3, 5	NC	No Connection

■ ABSOLUTE MAXIMUM RATINGS

PARAMETER			SYMBOL	RATINGS	Ta=25°C UNITS
Input Voltage			V _{IN}	-0.3 ~ 7.0	V
Output Current			I _{OUT}	500 ^{(*)1}	mA
Output Voltage			V _{OUT}	-0.3 ~ V _{IN} + 0.3	V
Power Dissipation	SOT-23	Pd	250 (IC only)		mW
			500(40mm x 40mm Standard board) ^{(*)2}		
	SOT-89		500 (IC only)		
			1000(40mm x 40mm Standard board) ^{(*)2}		
USP-6B		120 (IC only)			
		1000(40mm x 40mm Standard board) ^{(*)2}			
Operating Ambient Temperature			Topr	-40 ~ 85	°C
Storage Temperature			Tstg	-55 ~ 125	°C

(*)1 I_{OUT} ≤ Pd / (V_{IN} - V_{OUT})

(*)2 The power dissipation figure shown is PCB mounted and is for reference only.
Please refer to PACKAGING INFORMATION for the mounting condition.

ELECTRICAL CHARACTERISTICS

Ta=25°C

PARAMETER	SYMBOL	CONDITIONS	MIN.	TYP.	MAX.	UNITS	CIRCUIT	
Output Voltage (Standard) ^(*2)	V _{OUT(E)} ^(*3)	I _{OUT} =30mA	V _{OUT(T)} <1.5V	-0.03	V _{OUT(T)} ^(*4)	+0.03	V	②
Output Voltage (High Accuracy) ^(*2)			V _{OUT(T)} ≥1.5V	×0.98		×1.02		
		I _{OUT} =30mA	V _{OUT(T)} ≥2.0V	×0.99		×1.01		
Supply Current	I _{DD}		-	1.0	3.0	μA	①	
Load Regulation	ΔV _{OUT}	V _{OUT(T)} ≤1.8V, 1mA≤I _{OUT} ≤50mA		-	-	E-1 ^(*5)	mV	②
		V _{OUT(T)} >1.8V, 1mA≤I _{OUT} ≤100mA						
Dropout Voltage 1	V _{dif1} ^(*6)	I _{OUT} =30mA		-	E-2 ^(*5)		mV	②
Dropout Voltage 2	V _{dif2} ^(*6)	V _{OUT(T)} ≤1.8V, I _{OUT} =60mA		-	E-3 ^(*5)			
		V _{OUT(T)} >1.8V, I _{OUT} =100mA						
Line Regulation	ΔV _{OUT} / (ΔV _{IN} · V _{OUT})	V _{OUT(T)} <4.5V, V _{OUT(T)} +1.0V≤V _{IN} ≤6.0V, I _{OUT} =30mA		-	0.05	0.25	%V	②
		V _{OUT(T)} ≥4.5V, 5.5V≤V _{IN} ≤6.0V, I _{OUT} =30mA						
Maximum Output Current	I _{OUTMAX}	V _{OUT} ≥V _{OUT(E)} ×0.9		E-4 ^(*5)	-	-	mA	②
Short Circuit Current	I _{SHORT}	V _{OUT} =V _{SS}		-	E-5 ^(*5)	-	mA	②
Input Voltage	V _{IN}			1.8	-	6.0	V	②
Output Voltage Temperature Characteristics	ΔV _{OUT} / (ΔT _{opr} · V _{OUT})	I _{OUT} =30mA, -40°C≤T _{opr} ≤85°C		-	±100	-	ppm/°C	②

*1: Unless otherwise stated, V_{IN} = V_{OUT(T)} + 1.0V

*2: (Standard): ±2% (1.5V ≤ V_{OUT(T)}), ±0.03V (1.5V > V_{OUT(T)})
(High Accuracy): ±1% (2.0V ≤ V_{OUT(T)})

*3: V_{OUT(E)}: Effective output voltage.

*4: V_{OUT(T)}: Nominal voltage

*5: For E-1, E-2, E-3, E-4, E-5, Please refer to Electrical Characteristics Chart.

*6: V_{dif} = V_{IN1} - V_{OUT1}

V_{OUT1}: A voltage equal to 98% of the output voltage whenever an amply stabilized {V_{OUT(T)} + 1.0V} is input with each I_{OUT}.

V_{IN1}: The input voltage when V_{OUT1} appears as input voltage is gradually decreased.

*7: The low ESR capacitors use that is more than 1.0μF as C_L is possible.

■ ELECTRICAL CHARACTERISTICS (Continued)

● Electrical Characteristics Chart

NOMINAL VOLTAGE	E-1	E-2		E-3		E-4	E-5	
	LOAD REGULATION	DROPOUT VOLTAGE1		DROPOUT VOLTAGE2		MAX. OUTPUT CURRENT	SHORT CURRENT	
	ΔV_{OUT} (mV)	V_{dif1} (mV)		V_{dif2} (mV)		I_{OUTMAX} (mA)	I_{SHORT} (mA)	
$V_{OUT(T)}$	MAX.	TYP.	MAX.	TYP.	MAX.	MIN.	TYP.	
1.2	40	460	760	700	960	60	180	
1.3		400	650					
1.4		350	590	580	860			
1.5	45	300	510	450	810	80	155	
1.6		250	450					
1.7		200	410					
1.8		150	390	350	710			120
1.9	50	100	370			780		
2.0								
2.1								
2.2	55	100	370	250	680	200	100	
2.3								
2.4								
2.5								
2.6								
2.7								
2.8								
2.9								
3.0	60	75	350	250	680	200	100	
3.1								
3.2								
3.3								
3.4								
3.5	65	75	350	250	680	200	100	
3.6								
3.7								
3.8								
3.9	70	60	320	200	630	250	100	
4.0								
4.1								
4.2								
4.3								
4.4								
4.5	75	60	320	200	630	250	100	
4.6								
4.7								
4.8								
4.9								
5.0	80	50	290	175	600			

TEST CIRCUITS

Circuit ①

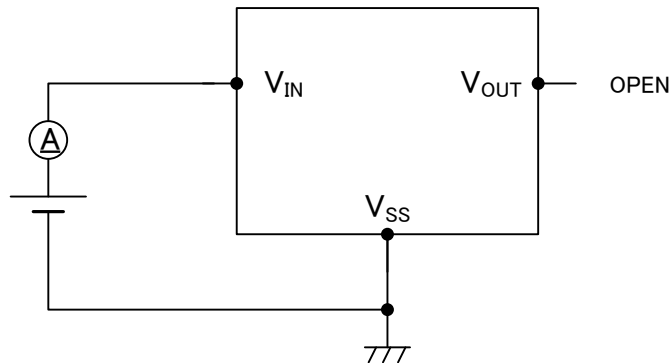

Circuit ②

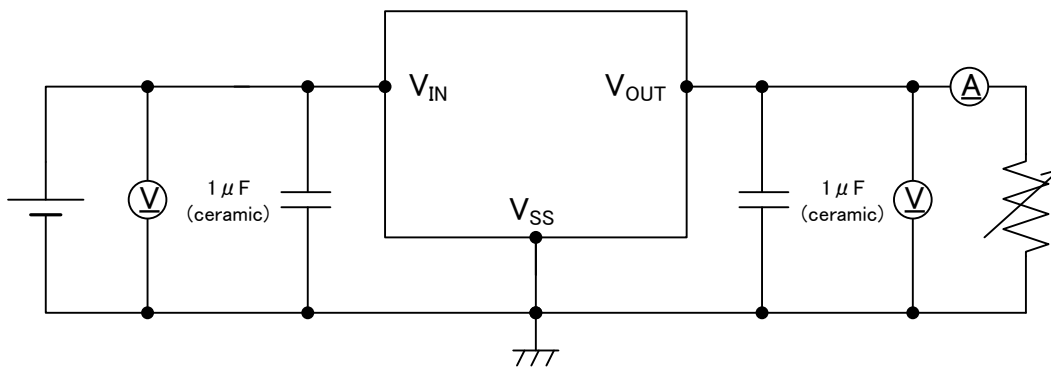

NOTES ON USE

1. For temporary, transitional voltage drop or voltage rising phenomenon, the IC is liable to malfunction should the ratings be exceeded.
2. Where wiring impedance is high, operations may become unstable due to noise and/or phase lag depending on output current. Please strengthen V_{IN} and V_{SS} wiring in particular
3. Please wire the input capacitor (C_{IN}) and the output capacitor (C_L) as close to the IC as possible.
4. Capacitances of these capacitors (C_{IN} , C_L) are decreased by the influences of bias voltage and ambient temperature. Care shall be taken for capacitor selection to ensure stability of phase compensation from the point of ESR influence.
5. When it is used in a quite small input / output dropout voltage, output may go into unstable operation. Please test it thoroughly before using it in production.
6. Torex places an importance on improving our products and their reliability. We request that users incorporate fail-safe designs and post-aging protection treatment when using Torex products in their systems.

TYPICAL PERFORMANCE CHARACTERISTICS

(1) Output Voltage vs. Output Current

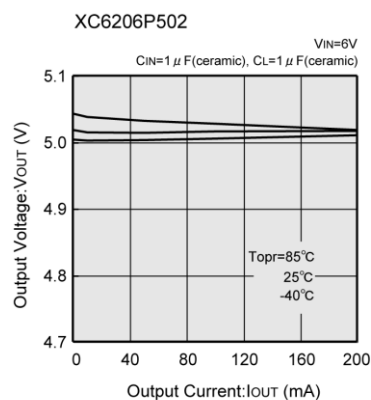
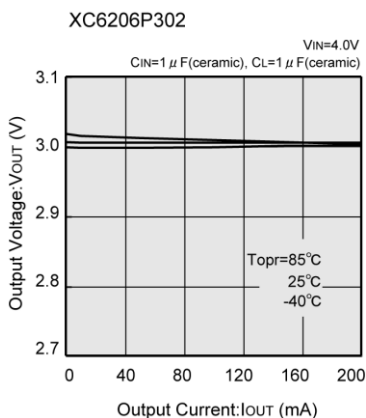
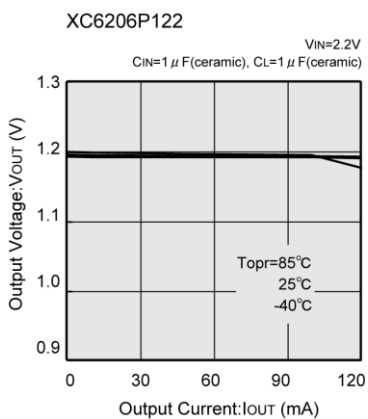

(2) Current Limit

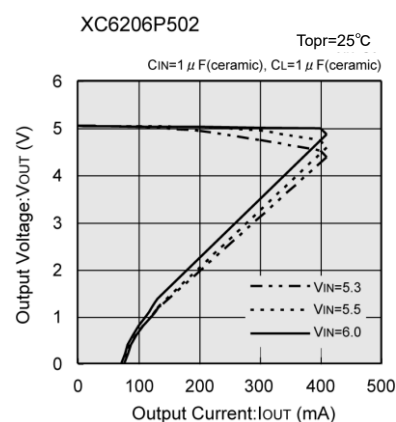
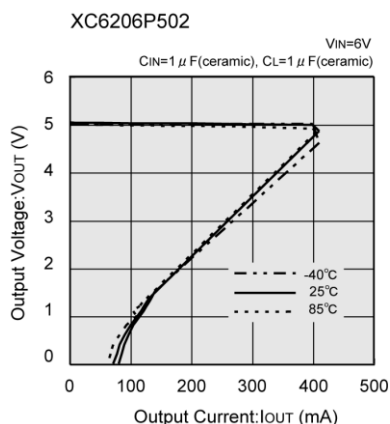
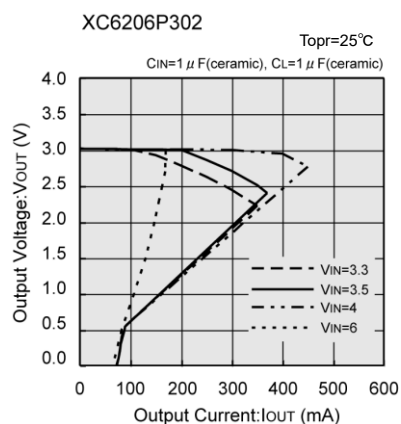
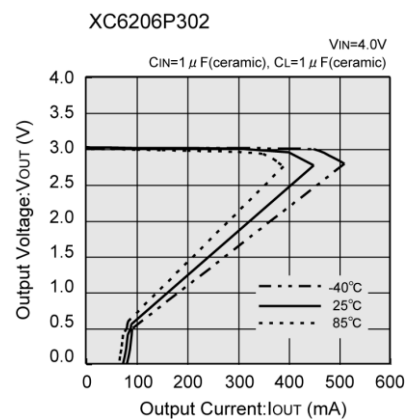
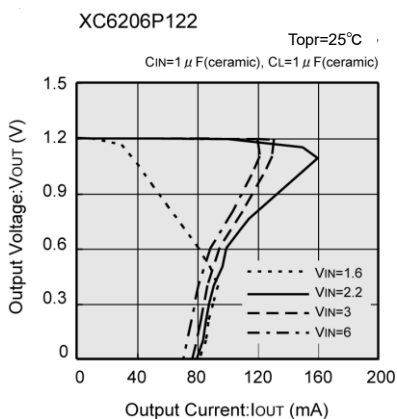
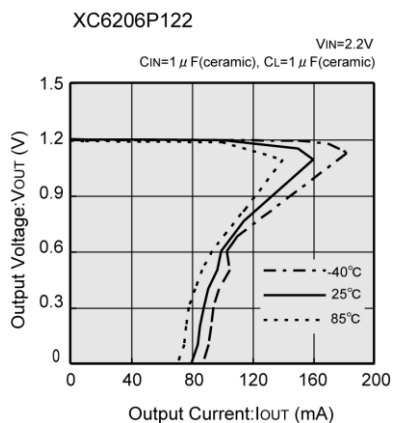

TYPICAL PERFORMANCE CHARACTERISTICS (Continued)

(3) Output Voltage vs. Input Voltage

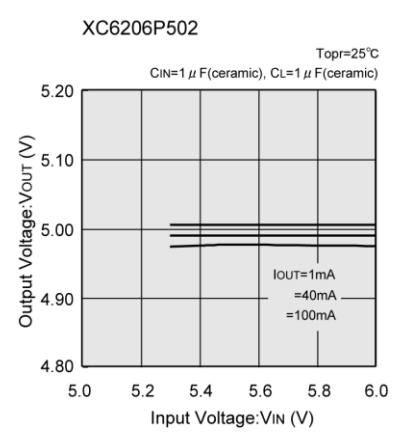
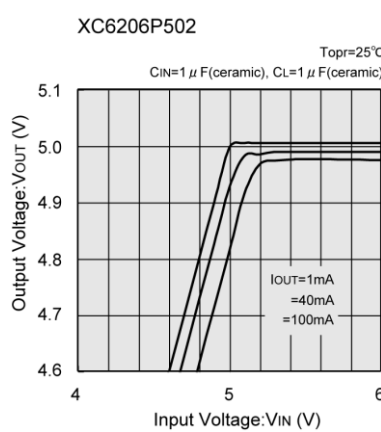
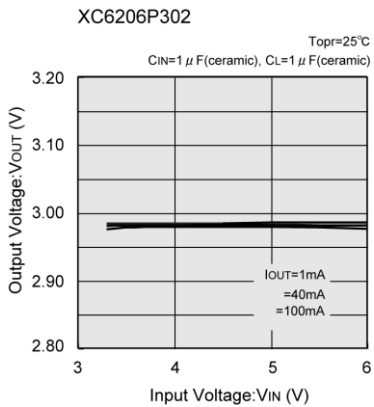
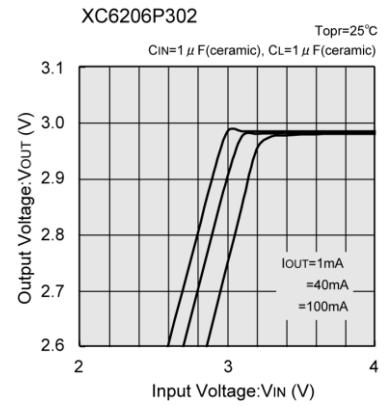
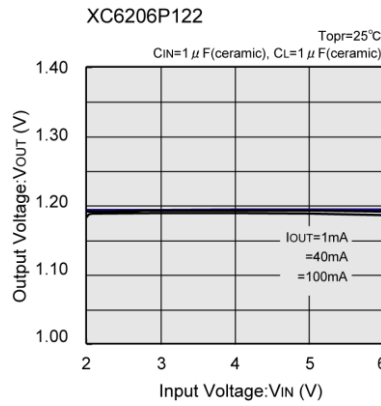
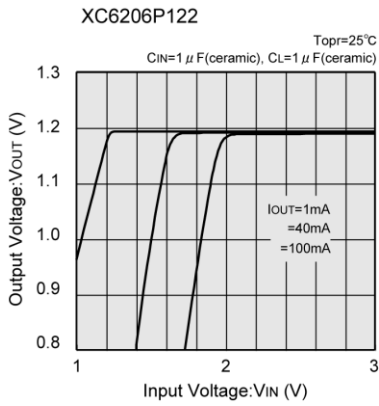

(4) Dropout Voltage vs. Output Current

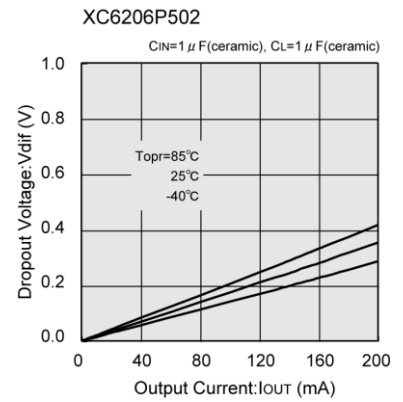
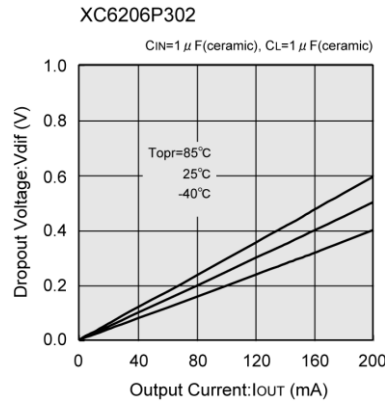
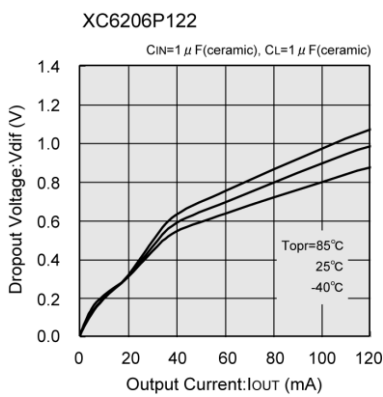

■ TYPICAL PERFORMANCE CHARACTERISTICS (Continued)

(5) Supply Current vs. Input Voltage

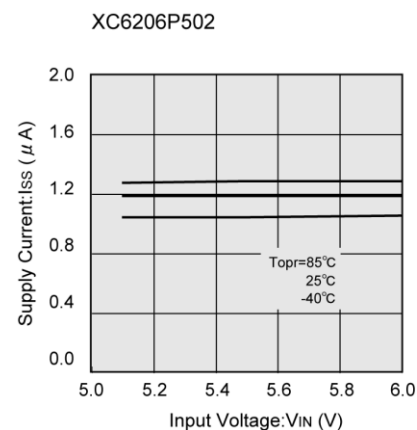
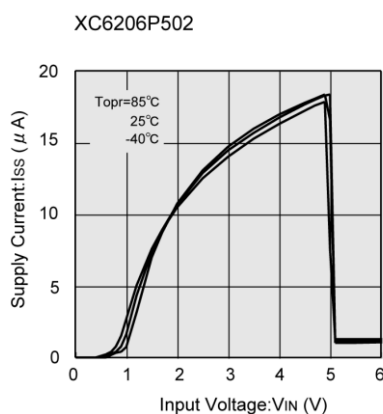
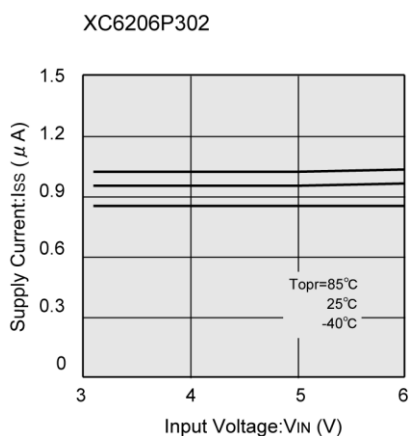
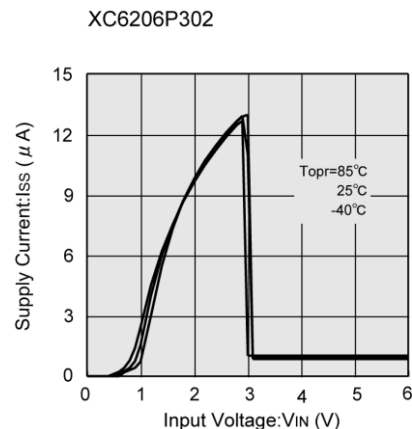
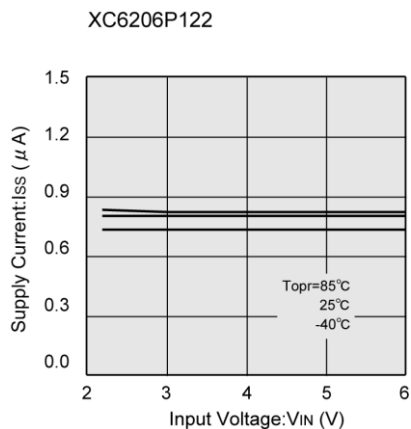
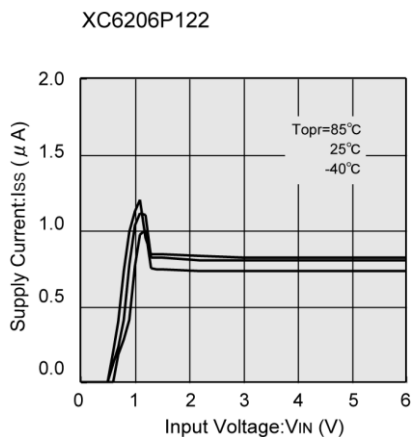

(6) Output Voltage vs. Ambient Temperature

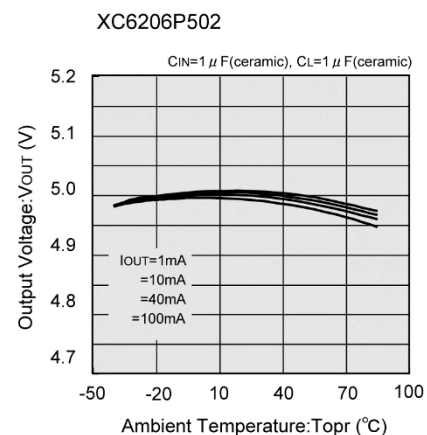
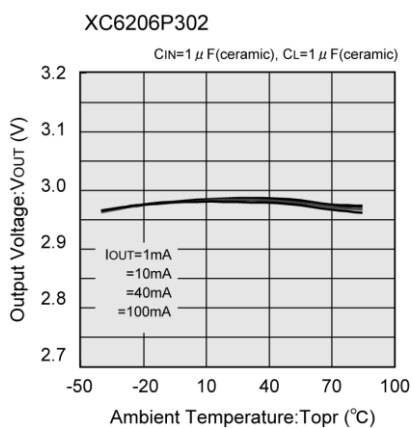
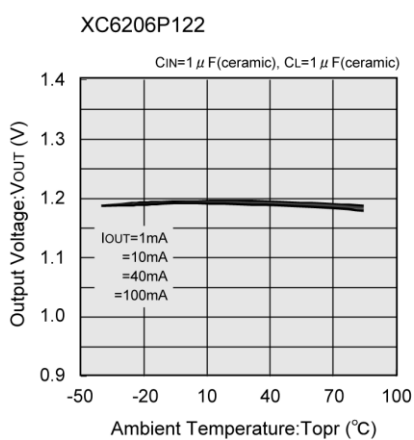

TYPICAL PERFORMANCE CHARACTERISTICS (Continued)

(7) Output Voltage vs. Ambient Temperature

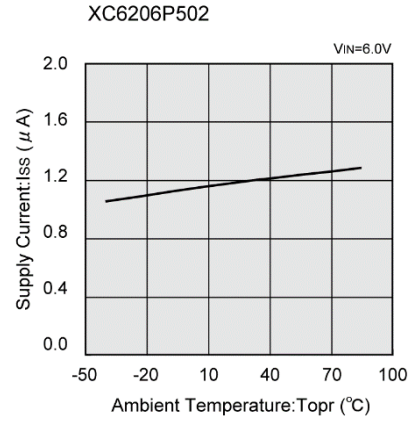
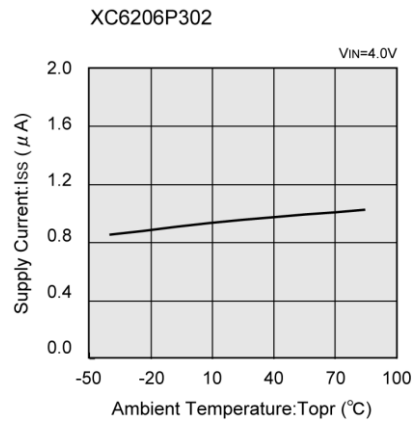
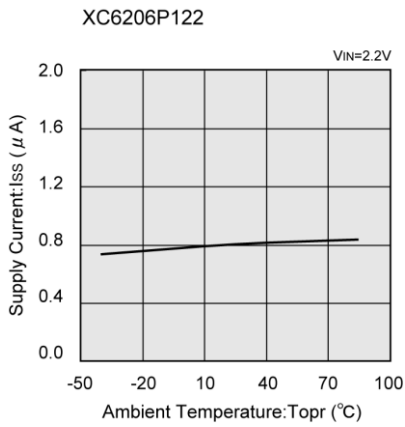

(8) Input Transient Response 1

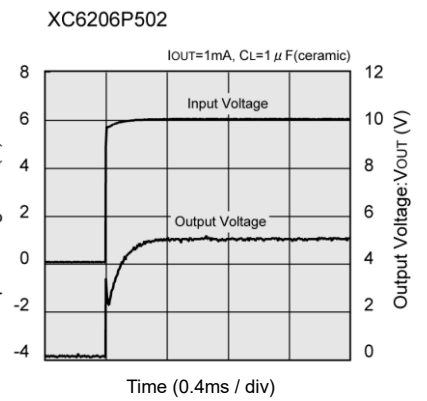
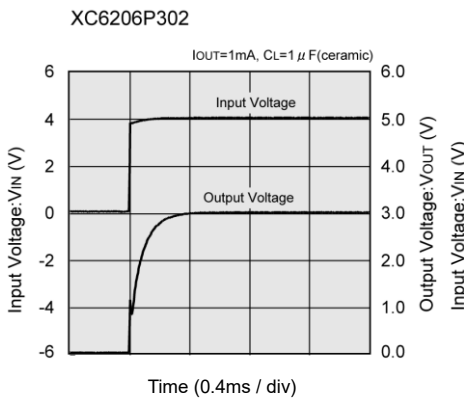
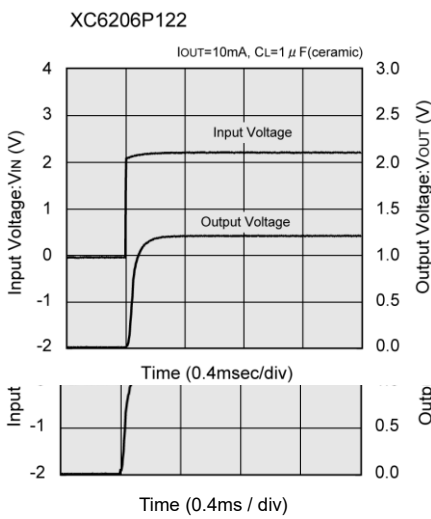
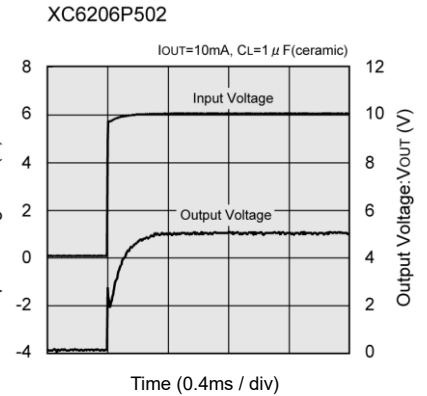
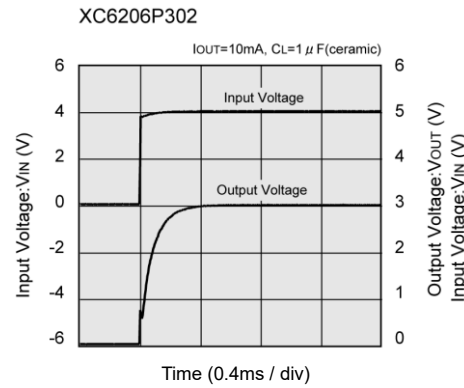
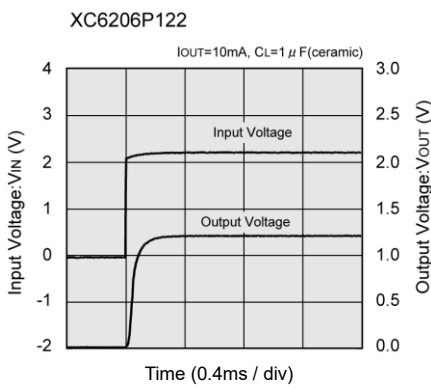

■ TYPICAL PERFORMANCE CHARACTERISTICS (Continued)

(9) Input Transient Response 2

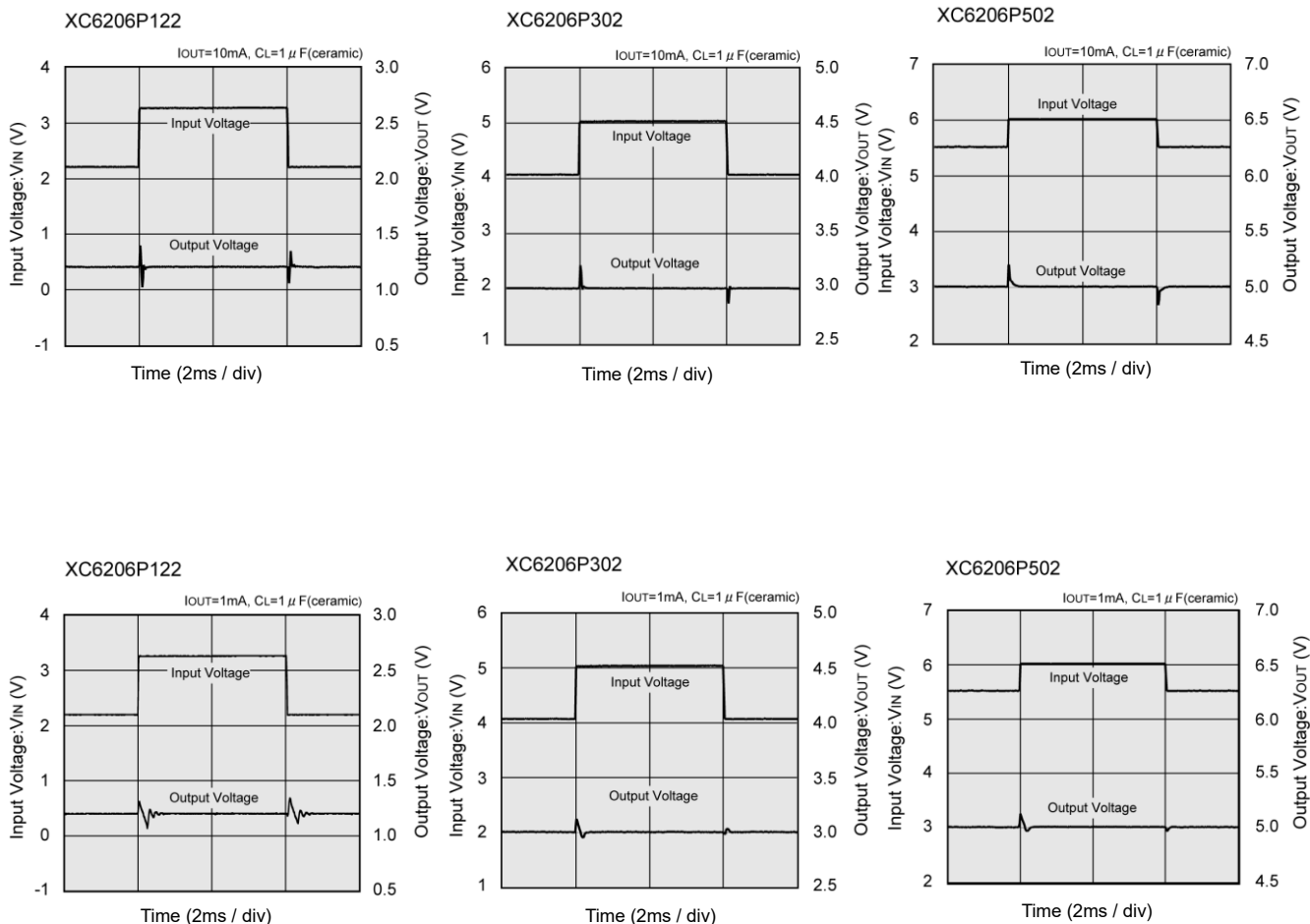

(10) Load Transient Response

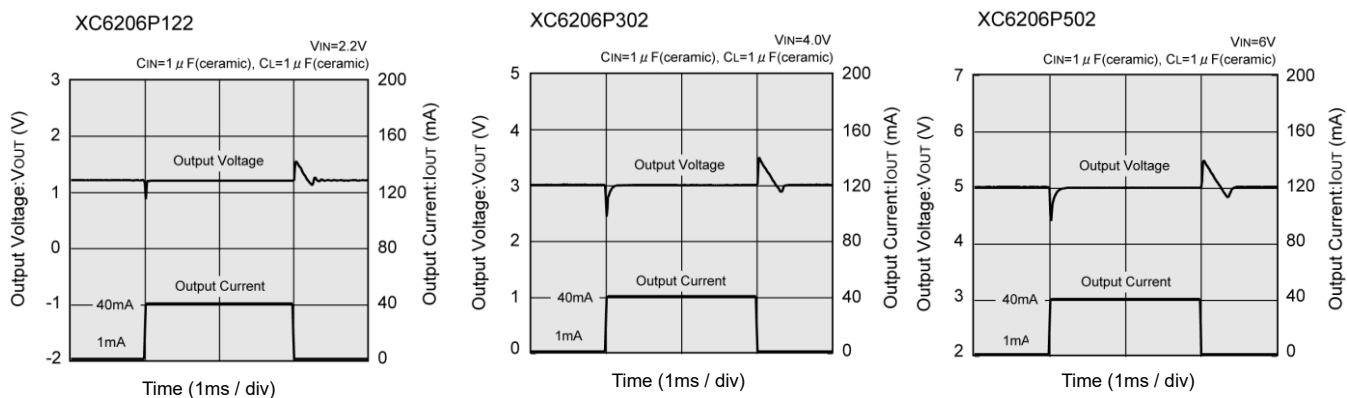

TYPICAL PERFORMANCE CHARACTERISTICS (Continued)

(11) Ripple Rejection Rate

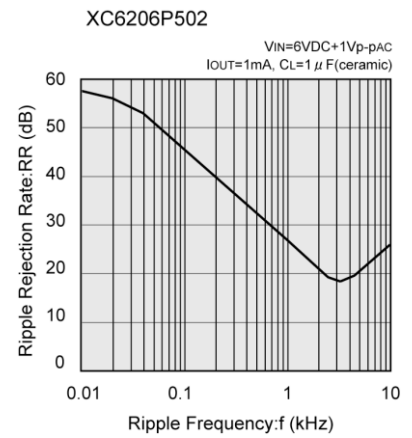
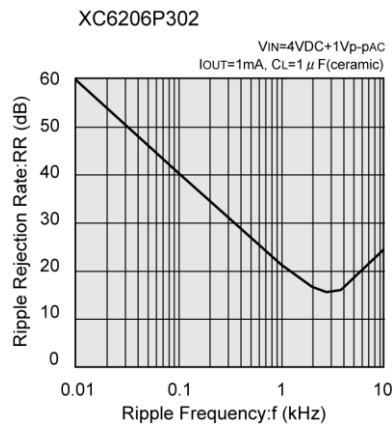
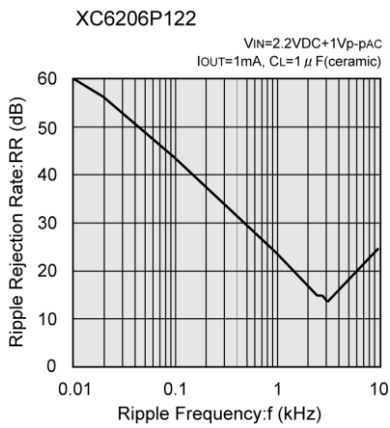
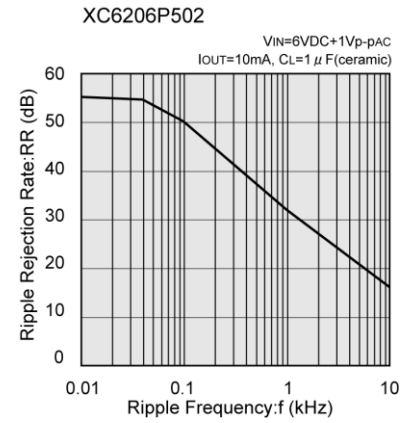
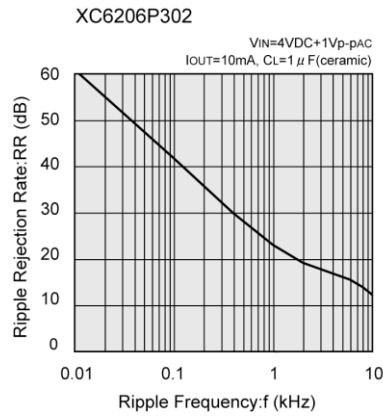
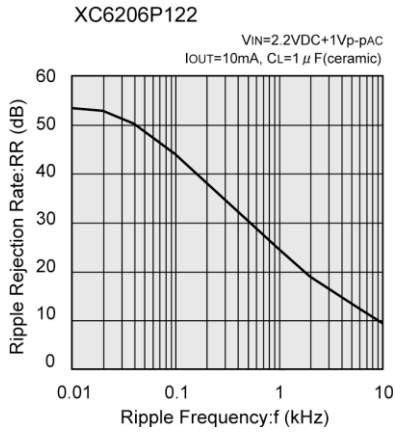

■ PACKAGING INFORMATION

For the latest package information go to, www.torexsemi.com/technical-support/packages

PACKAGE	OUTLINE / LAND PATTERN	THERMAL CHARACTERISTICS
SOT-23	SOT-23 PKG	SOT-23 Power Dissipation
SOT-89	SOT-89 PKG	SOT-89 Power Dissipation
USP-6B	USP-6B PKG	USP-6B Power Dissipation

XC6206 Series

MARKING RULE

●SOT-23, SOT-89

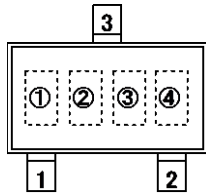

SOT-23
(TOP VIEW)

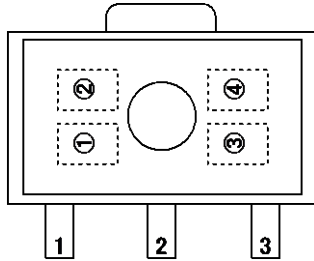

SOT-89
(TOP VIEW)

① represents product number

MARK	PRODUCT SERIES
6	XC6206P*****

② represents 3 pins regulator

MARK		PRODUCT SERIES
VOLTAGE=0.1 ~ 3.0V	VOLTAGE=3.1 ~ 6.0V	
5	6	XC6206P*****

③ represents output voltage

MARK	VOLTAGE (V)			MARK	OUTPUT VOLTAGE (V)		
0	-	3.1	-	F	1.6	4.6	-
1	-	3.2	-	H	1.7	4.7	-
2	-	3.3	-	K	1.8	4.8	-
3	-	3.4	-	L	1.9	4.9	-
4	-	3.5	-	M	2.0	5.0	-
5	-	3.6	-	N	2.1	-	-
6	-	3.7	-	P	2.2	-	-
7	-	3.8	-	R	2.3	-	-
8	-	3.9	-	S	2.4	-	-
9	-	4.0	-	T	2.5	-	-
A	-	4.1	-	U	2.6	-	-
B	1.2	4.2	-	V	2.7	-	-
C	1.3	4.3	-	X	2.8	-	-
D	1.4	4.4	-	Y	2.9	-	-
E	1.5	4.5	-	Z	3.0	-	-

④ represents production lot number

0 to 9, A to Z repeated. (G, I, J, O, Q, W excluded)

●USP-6B



USP-6B
(TOP VIEW)

①② represents product number

MARK		PRODUCT SERIES
①	②	
0	6	XC6206P***D*

③ represents 3 pins regulator

MARK	PRODUCT SERIES
P	XC6206P***D*

④⑤ represents output voltage

MARK		OUTPUT VOLTAGE(V)	PRODUCT SERIES
④	⑤		
3	3	3.3	XC6206P33*D*
5	0	5.0	XC6206P50*D*

⑥ represents production lot number

0 to 9, A to Z repeated. (G, I, J, O, Q, W excluded)