

TF03-100 is an industrial-grade long-range LiDAR. Its maximum detection range can reach 100m. With integrated compensating algorithm for outdoor glare and other interference, TF03-100 can work under strong light environment and rain, fog and snow conditions¹. Multiple built-in operating modes let customers to change its parameters and configuration to meet different applications.



Main product features

- High frame rate
- IP67 protection
- Small size
- Various interface

Main application scenarios

- Vehicle collision avoidance and safety warning
- Traffic flow statistics
- Camera trigger
- UAV assisted takeoff and landing

SPECIFICATIONS

Parameters		Standard version	RS485/RS232 version
Product performance	Operating range	0.1-100m@90% reflectivity 0.1-40m@10% reflectivity 0.1-80m@90% reflectivity&100Klux 0.1-30m@10% reflectivity&100Klux	
	Accuracy ²	±10cm (within 10m), 1% (10m and further)	
	Distance resolution	1cm	
	Frame rate ³	1Hz~1000Hz adjustable (default 100Hz)	
	Repeatability	1σ: <3cm	
	Ambient light immunity	100Klux	
	Operation temperature	-25~60°C	
	Enclosure rating	IP67	
Optical parameters	Light source	LD	

¹ Rain, snow and fog conditions generally refer to moderate rain, snow and below. Moderate rainfall < 25mm/24h or < 7.9mm/h

² The detection range is measured at temperature of 25°C. Accuracy and repeatability are measured with white board (90% reflectivity).

³ The highest frame rate can be customized to 10KHz, please contact us for detailed information.

	Central wavelength	905nm	
	Photobiological safety	Class1 (EN60825)	
	FOV ⁴	0.5°	
Electrical parameters	Supply voltage	5V~24V	
	Average current	≤150mA @ 5V, ≤80mA @ 12V, ≤50mA @ 24V	
	Power consumption	≤1W	
	peak current	150mA	
	Communication interface level	LVTTL (3.3V)	RS485/RS232
	Communication interface	UART/CAN	RS485/RS232
Others	Dimension	44mm*43mm*32mm(L*W*H)	
	Enclosure material	Aluminum alloy	
	Storage temperature	-40~85°C	
	Weight	89g±3g	92g±3g
	Cable length	70cm	

■ DIMENSIONS

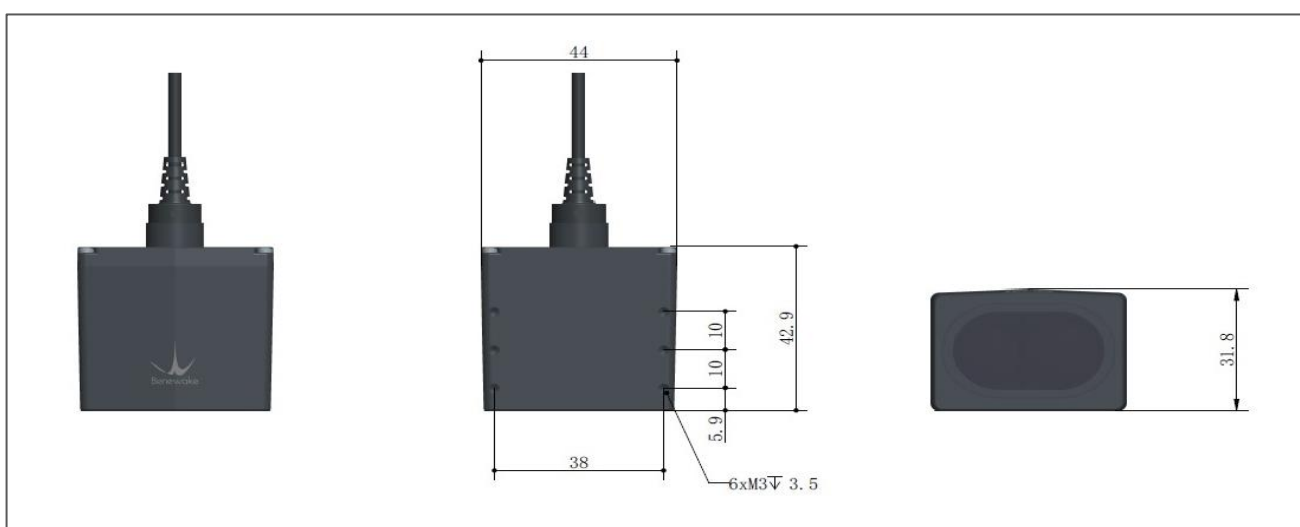

Figure 1 TF03-100 dimensions (Left 1: top view; Left 2: upward view; Left 3: front view) Unit: mm

⁴ FOV, field of view, consists of vertical angle and horizontal angle.

■ COMMUNICATION INTERFACE

Parameters	UART/RS485/RS232
Baud rate	115200
Data bit	8
Stop bit	1
Checksum bit	N/A

Parameters	CAN
Baud rate	1000kbps
Data bit	0x3003
Stop bit	0x3
Frame format	Standard frame ⁵

■ CONFIGURABLE PARAMETERS

Table 1 Configurable parameters example

Configurable parameters	Description	Default setting
Frame rate	Output frame rate could be configured by related command, range 1~1000Hz ⁶	100Hz
Communication interfaces	UART/CAN can be switched with command	UART
	RS485/RS232 can be switched with command	RS485
Baud rate	a) Serial port baud rate could be customized b) CAN port baud rate could be customized, CAN ID could be modified	/
Restore default	TF03-100 can be restored to the factory settings	/
Save configuration	After defining the configuration parameters, you can send the corresponding command to choose to save the configuration permanently	/

Note: for more configurable parameters and instructions, please refer to the user manual.

⁵ Please check Product manual for detailed information.

⁶ The highest frame rate can be customized to 10KHz, please contact us for detailed information.