

# TK 2518 – Polystyrene and Polycarbonate – 254 x 180 mm (10.0 x 7.09 in.)

## Standard Features

- **Protection Level:** IP66 (NEMA Type: 4X with gray cover, 12K with transparent cover)
- **Technical:** Smooth or Knockout Sidewalls  
Gray or Tinted Transparent Cover  
Multiple Enclosure Mounting Options
- **UL Recognized**  
**Enclosure Materials:** Polystyrene or Polycarbonate
- **Gasket Material:** Polyurethane
- **Color:** Light Gray
- **Material**  
**Temperature Range:** Polystyrene  
-40°C to 70°C (-40°F to 158°F)  
Polycarbonate  
-40°C to 120°C (-40°F to 248°F)
- **Accessories:** See section below



### Smooth Sidewalls

Ordering Information	Height mm (in)	Polystyrene				Polycarbonate			
		Cat. No.	Type	Cover Color	Std. Pk.	Cat. No.	Type	Cover Color	Std. Pk.
☐ Enclosure - low cover	90 mm (3.54 in)	110-408	PS 2518-9-o	gray	1	120-408	PC 2518-9-o	gray	1
☐ Enclosure - high cover	111 mm (4.37 in)	110-908	PS 2518-11-o	gray	1	120-908	PC 2518-11-o	gray	1
☐ Enclosure - top hat cover	165 mm (6.50 in)	109-408	PS 2518-16-o	gray	1	121-408	PC 2518-16-o	gray	1
☐ Enclosure - low cover	90 mm (3.54 in)	111-008	PS 2518-9-to	trans.	1	130-008	PC 2518-9-to	trans.	1
☐ Enclosure - high cover	111 mm (4.37 in)	111-508	PS 2518-11-to	trans.	1	130-508	PC 2518-11-to	trans.	1
☐ Enclosure - top hat cover	165 mm (6.50 in)	112-008	PS 2518-16-to	trans.	1	131-008	PC 2518-16-to	trans.	1

### Sidewalls with Metric Knockouts

Ordering Information	Height mm (in)	Polystyrene				Polycarbonate			
		Cat. No.	Type	Cover Color	Std. Pk.	Cat. No.	Type	Cover Color	Std. Pk.
☐ Enclosure - low cover	90 mm (3.54 in)	105-408	PS 2518-9-m	gray	1	127-408	PC 2518-9-m	gray	1
☐ Enclosure - high cover	111 mm (4.37 in)	105-908	PS 2518-11-m	gray	1	127-908	PC 2518-11-m	gray	1
☐ Enclosure - top hat cover	165 mm (6.50 in)	104-408	PS 2518-16-m	gray	1	128-408	PC 2518-16-m	gray	1
☐ Enclosure - low cover	90 mm (3.54 in)	106-008	PS 2518-9-tm	trans.	1	137-008	PC 2518-9-tm	trans.	1
☐ Enclosure - high cover	111 mm (4.37 in)	106-508	PS 2518-11-tm	trans.	1	137-508	PC 2518-11-tm	trans.	1
☐ Enclosure - top hat cover	165 mm (6.50 in)	107-008	PS 2518-16-tm	trans.	1	138-008	PC 2518-16-tm	trans.	1

### Accessories

Ordering Information	Cat. No.	Type	Std. Pk.
Mounting Plate (plastic)	195-008	TKMPI-2518	1
Mounting Plate (steel)	197-008	TKMPS-2518	1
DIN Rail TS35-216mm	198-216	TS 35/216	1
Hinge Kit Set	190-005	HK2	1
Mounting Tab Kit	194-001	MT1	1

Please refer to pages 149-152 for additional accessories and detailed information.

Dimensions

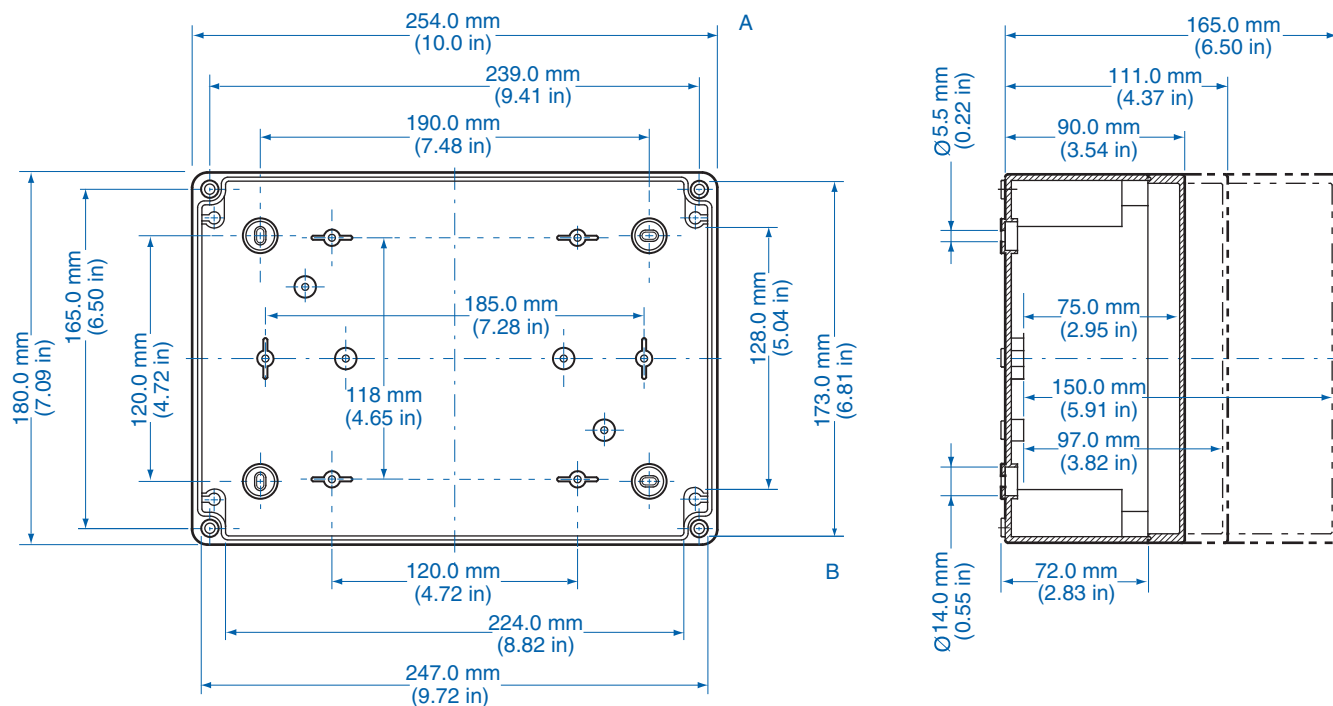

Knockout Positions

Side A

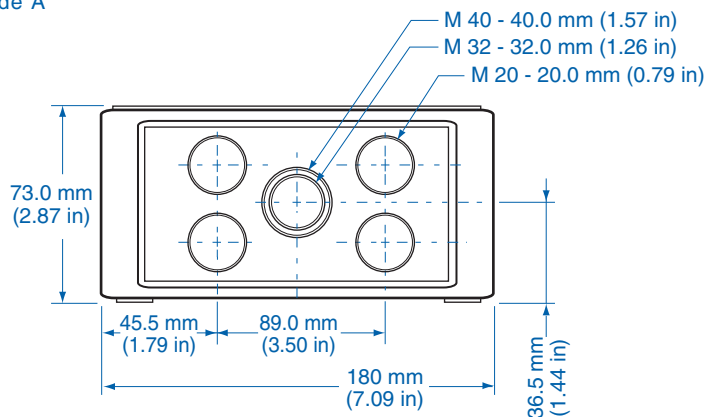

Side B

