



Typical Applications

Prescaler for DC to C Band PLL Applications:

- UNII, Point-to-Point & VSAT Radios
- 802.11a & HiperLAN WLAN
- Fiber Optic
- Cellular / 3G Infrastructure

Features

- SSB Phase Noise: -153 dBc/Hz @100 kHz
- Wide Bandwidth
- Output Power: -1 dBm
- Single DC Supply: +5V @ 80 mA
- MS8G SMT Package

Functional Diagram

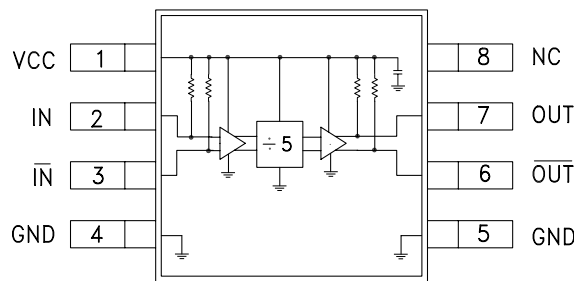

General Description

The HMC438MS8G & HMC438MS8GE are low noise Divide-by-5 Static Dividers utilizing InGaP GaAs HBT technology in low cost 8 lead surface mount plastic packages. This device operates from DC (with a square wave input) to 7 GHz input frequency from a single +5V DC supply. The low additive SSB phase noise of -153 dBc/Hz at 100 kHz offset helps the user maintain good system noise performance.

Electrical Specifications, $T_A = +25^\circ\text{C}$, 50 Ohm System, $V_{CC} = 5V$

Parameter	Conditions	Min.	Typ.	Max.	Units
Maximum Input Frequency		7.0	7.5		GHz
Minimum Input Frequency	Sine Wave Input [1]		0.1		GHz
Input Power Range	$F_{in} = 1$ to 5 GHz	-15		+12	dBm
	$F_{in} = 5$ to 6 GHz	-15		+10	dBm
	$F_{in} = 6$ to 7 GHz	-15		+5	dBm
Output Power		-4	-1		dBm
Reverse Leakage	Both RF Outputs Terminated		-50		dBm
SSB Phase Noise (100 kHz offset)	$P_{in} = 0$ dBm, $F_{in} = 6$ GHz		-153		dBc/Hz
Output Transition Time	$P_{in} = 0$ dBm, $F_{out} = 882$ MHz		100		ps
Supply Current (I_{CC})			80		mA

1. Divider will operate down to DC for square-wave input signal.

Information furnished by Analog Devices is believed to be accurate and reliable. However, no responsibility is assumed by Analog Devices for its use, nor for any infringements of patents or other rights of third parties that may result from its use. Specifications subject to change without notice. No license is granted by implication or otherwise under any patent or patent rights of Analog Devices. Trademarks and registered trademarks are the property of their respective owners.

For price, delivery, and to place orders: Analog Devices, Inc., One Technology Way, P.O. Box 9106, Norwood, MA 02062-9106
Phone: 781-329-4700 • Order online at www.analog.com
Application Support: Phone: 1-800-ANALOG-D



**SMT GaAs HBT MMIC
DIVIDE-BY-5, DC - 7 GHz**

Input Sensitivity Window, $T = 25\text{ }^{\circ}\text{C}$

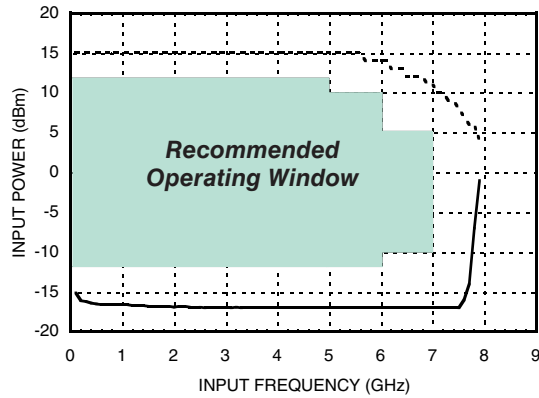

Input Sensitivity Window vs. Temperature

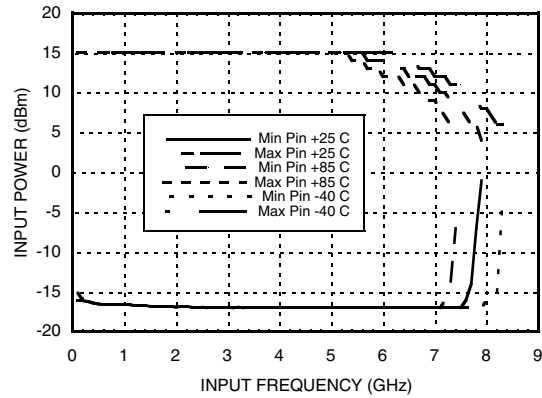

Output Power vs. Temperature

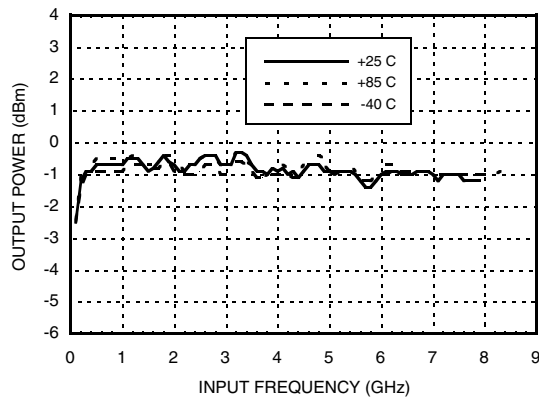

**SSB Phase Noise Performance,
 $P_{in} = 0\text{ dBm}$, $F_{in} = 6\text{ GHz}$, $T = 25\text{ }^{\circ}\text{C}$**

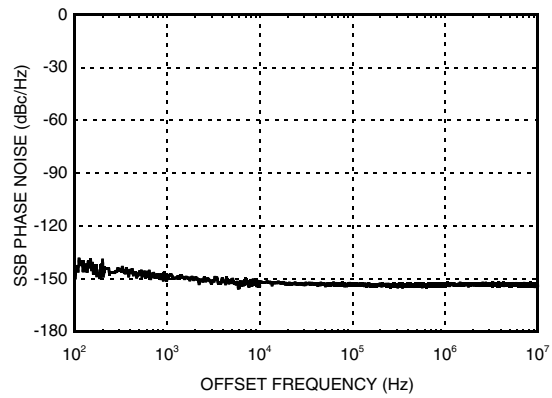

Output Harmonic Content, $P_{in} = 0\text{ dBm}$, $T = 25\text{ }^{\circ}\text{C}$

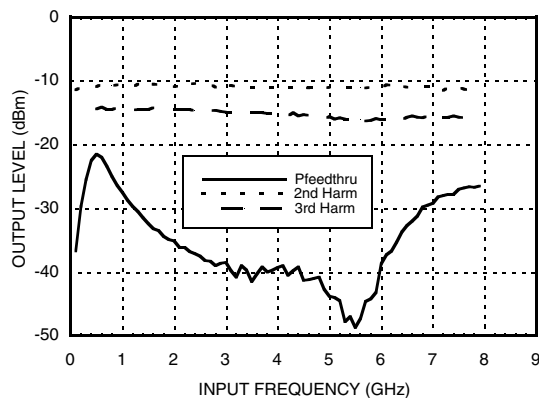

Reverse Leakage, $P_{in} = 0\text{ dBm}$, $T = 25\text{ }^{\circ}\text{C}$

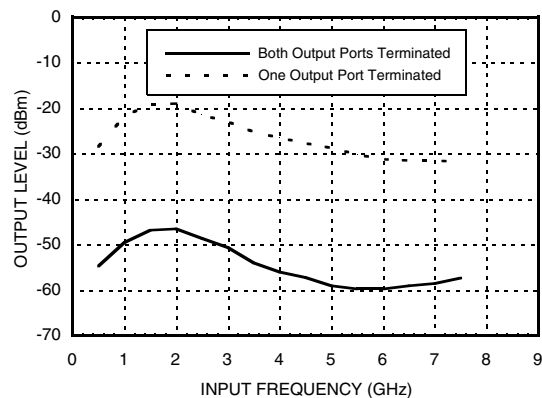



**Output Voltage Waveform,
Pin= 0 dBm, Fout= 882 MHz, T= 25 °C**

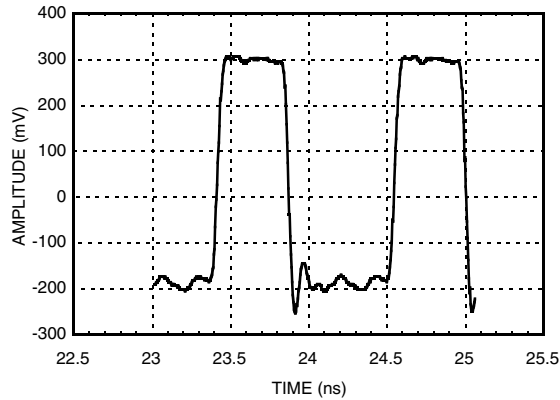

Absolute Maximum Ratings

RF Input Power (Vcc = +5V)	13 dBm
Nominal +5V Supply to GND	-0.3V to +5.5V
Max Peak Flow Temperature	260 °C
Storage Temperature	-65 to +125 °C
ESD Sensitivity (HBM)	Class 1A

Reliability Information

Junction Temperature to Maintain 1 Million Hour MTTF	135 °C
Nominal Junction Temperature (T = 85 °C)	122 °C
Thermal Resistance (Junction to GND Paddle, 5V Supply)	88.5 °C/W
Operating Temperature	-40 to +85 °C

DC blocking capacitors are required at RF input and RF output ports.
Choose value for lowest frequency of operation.

Typical Supply Current vs. Vcc

Vcc (V)	Icc (mA)
4.75	75
5.0	80
5.25	87

Note: Divider will operate over full voltage range shown above



**ELECTROSTATIC SENSITIVE DEVICE
OBSERVE HANDLING PRECAUTIONS**



Outline Drawing

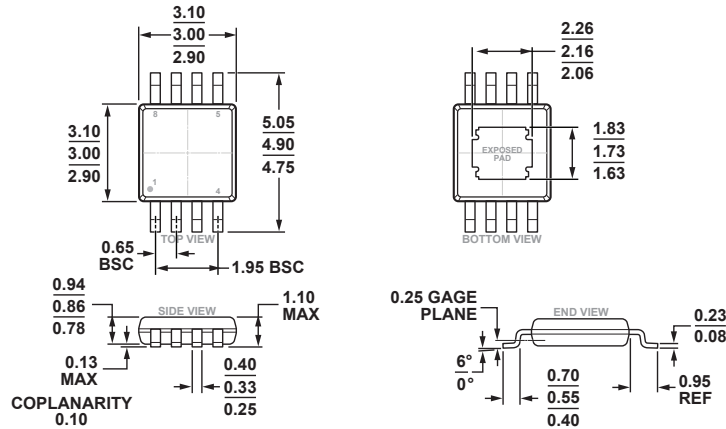

06-02-2019-15

06-02-2019-15

COMPLIANT TO JEDEC STANDARDS MO-187-AA-T

8-Lead Mini Small Outline Package with Exposed Pad [MINI_SO_EP]
(RH-8-1)

Dimensions shown in millimeters

Package Information

Part Number	Package Body Material	Lead Finish	MSL Rating	Package Marking ^[3]
HMC438MS8G	Low Stress Injection Molded Plastic	Sn/Pb Solder	MSL1 ^[1]	H438 XXXX
HMC438MS8GTR	Low Stress Injection Molded Plastic	Sn/Pb Solder	MSL1 ^[1]	H438 XXXX
HMC438MS8GE	RoHS-compliant Low Stress Injection Molded Plastic	100% matte Sn	MSL1 ^[2]	H438 XXXX
HMC438MS8GETR	RoHS-compliant Low Stress Injection Molded Plastic	100% matte Sn	MSL1 ^[2]	H438 XXXX
105786- HMC438MS8G	Eval Board			

[1] Max peak reflow temperature of 235 °C

[2] Max peak reflow temperature of 260 °C

[3] 4-Digit lot number XXXX

Pin Description

Pin Number	Function	Description	Interface Schematic
1	Vcc	Supply voltage 5V ± 0.25V.	
2	IN	RF input must be DC blocked.	



**SMT GaAs HBT MMIC
DIVIDE-BY-5, DC - 7 GHz**

Pin Description (Continued)

Pin Number	Function	Description	Interface Schematic
3	$\overline{\text{IN}}$	RF input 180° out of phase with pin 2 for differential operation. AC ground for single ended operation.	
4, 5	GND	All ground leads and ground paddle must be soldered to PCB RF/DC ground.	
6	$\overline{\text{OUT}}$	Divided output 180° out of phase with pin 7.	
7	OUT	Divided Output.	
8	N/C	The pins are not connected internally; however, all data shown herein was measured with these pins connected to RF/DC ground externally.	

Application Circuit

