

# Male Style 1/2 B

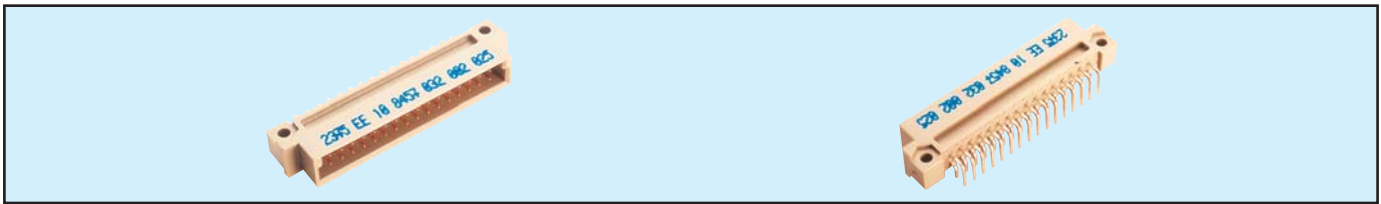

## Series 8457 – 2 rows (2 x 16)



Contact Design and Termination Length	Number of Contacts	Loading Description	Part Number Performance classes according to DIN 41612	
			II	I
3.4 mm (Y) Straight	32	a + b fully loaded	10 8457 032 001 025	10 8457 032 001 049
	16	a + b even loading	10 8457 032 001 031	10 8457 032 001 055
	16	a loading only	10 8457 032 001 027	10 8457 032 001 051
3.0 mm (Y) Right Angled	32	a + b fully loaded	10 8457 032 002 025	10 8457 032 002 049
	16	a + b even loading	10 8457 032 002 031	10 8457 032 002 055
	16	a loading only	10 8457 032 002 027	10 8457 032 002 051
13.0 mm (Y) Straight	30 + 2	fully loaded + ground	10 8457 032 102 025	10 8457 032 102 049
	32	a + b fully loaded	10 8457 032 003 025	10 8457 032 003 049
	16	a + b even loading	10 8457 032 003 031	10 8457 032 003 055
11.3 mm (Y) Right Angled	16	a loading only	10 8457 032 003 027	10 8457 032 003 051
	32	a + b fully loaded	10 8457 032 004 025	10 8457 032 004 049
	16	a + b even loading	10 8457 032 004 031	10 8457 032 004 055
2.3 mm (Y) Right Angled	16	a loading only	10 8457 032 004 027	10 8457 032 004 051
	32	a + b fully loaded	10 8457 032 008 025	10 8457 032 008 049
	16	a + b even loading	10 8457 032 008 031	10 8457 032 008 055
	16	a loading only	10 8457 032 008 027	10 8457 032 008 051
	30 + 2	fully loaded + ground	10 8457 032 108 025	10 8457 032 108 049

NB: Alternative Prefix Variations Available: 12, 16 & 17, please refer to Page 10.

Additional Plating & Loading Variations: Please contact your local AVX sales office or distributor.

### LOADING DESCRIPTION

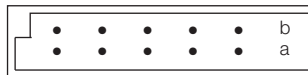

32 contacts, rows a + b fully loaded

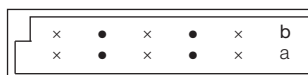

16 contacts, rows a + b even loading

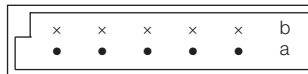

16 contacts, row a loading only

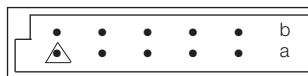

30 + 2 contacts, fully loaded with ground in A1 & A16

△ denotes ground pin

### DIMENSIONS

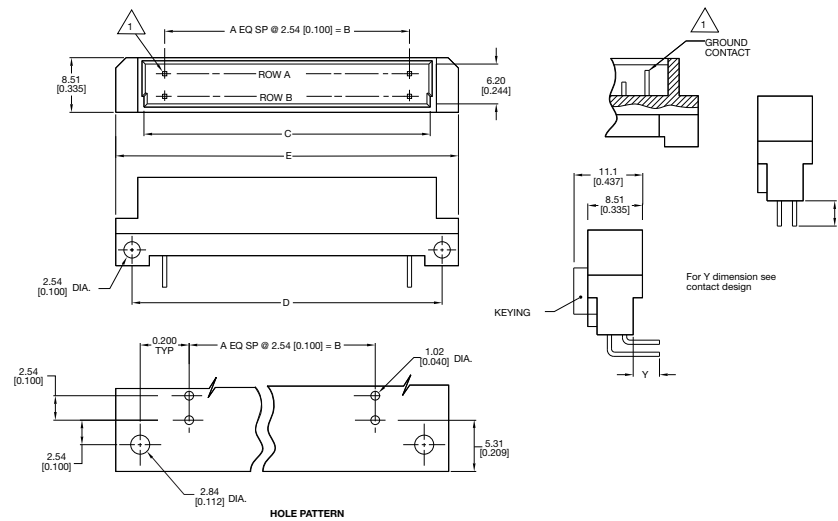

Unit: millimeters (inches)

No. Contact Positions	Contact Rows	A	B	C	D	E
32	2 (2 x 16)	15	38.10 (1.500)	44.55 (1.754)	48.26 (1.900)	53.34 (2.100)

# Female Style 1/2 B

## Series 8457 – 2 rows (2 x 16)

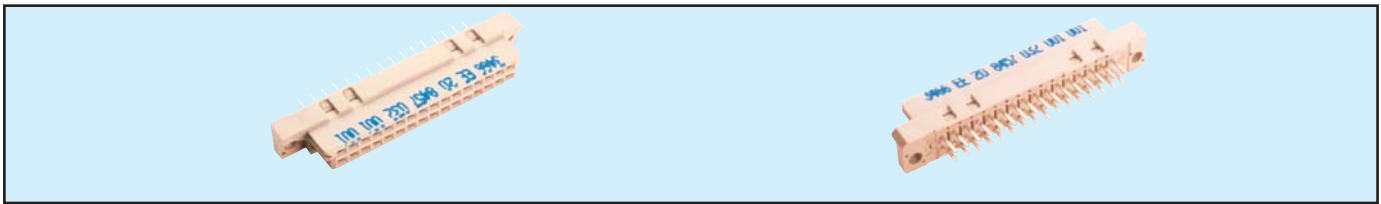

Contact Design and Termination Length	Number of Contacts	Loading Description	Part Number Performance classes according to DIN 41612	
			II	I
0.6 x 0.6 mm post profile 4.5 mm (Y) Straight	32	a + b fully loaded	20 8457 032 001 025	20 8457 032 001 049
	16	a + b even loading	20 8457 032 001 031	20 8457 032 001 055
	16	a loading only	20 8457 032 001 027	20 8457 032 001 051
0.6 x 0.6 mm post profile 2.9 mm (Y) Straight	32	a + b fully loaded	20 8457 032 002 025	20 8457 032 002 049
	16	a + b even loading	20 8457 032 002 031	20 8457 032 002 055
	16	a loading only	20 8457 032 002 027	20 8457 032 002 051
0.6 x 0.6 mm post profile 13.0 mm (Y) Straight	32	a + b fully loaded	20 8457 032 005 025	20 8457 032 005 049
	16	a + b even loading	20 8457 032 005 031	20 8457 032 005 055
	16	a loading only	20 8457 032 005 027	20 8457 032 005 051
0.6 x 0.6 mm post profile 7.0 mm (Y) Straight	32	a + b fully loaded	20 8457 032 010 025	20 8457 032 010 049
	16	a + b even loading	20 8457 032 010 031	20 8457 032 010 055
	16	a loading only	20 8457 032 010 027	20 8457 032 010 051
0.6 x 0.6 mm post profile 3.5 mm (Y) Straight	32	a + b even loading	20 8457 032 011 025	20 8457 032 011 049
	16	a + b fully loaded	20 8457 032 011 031	20 8457 032 011 055
	16	a loading only	20 8457 032 011 027	20 8457 032 011 051
0.6 x 0.6 mm post profile 19.4 mm (Y) Straight	32	a + b fully loaded	20 8457 032 012 025	20 8457 032 012 049
	16	a + b even loading	20 8457 032 012 031	20 8457 032 012 055
	16	a loading only	20 8457 032 012 027	20 8457 032 012 051
0.6 x 0.6 mm post profile 4.5 mm (Y) Right Angled	32	a + b fully loaded	20 8457 032 013 025	20 8457 032 013 049
	16	a + b even loading	20 8457 032 013 031	20 8457 032 013 055
	16	a loading only	20 8457 032 013 027	20 8457 032 013 051

NB: Alternative Prefix Variations Available: 22, 24, 25, 26 & 27, please refer to Page 10.

Additional Plating & Loading Variations: Please contact your local AVX sales office or distributor.

### LOADING DESCRIPTION

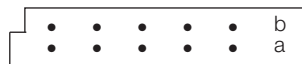

32 contacts, rows a + b fully loaded

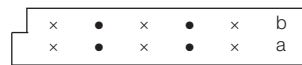

16 contacts, rows a + b even loading

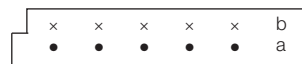

16 contacts, row a loading only

### DIMENSIONS

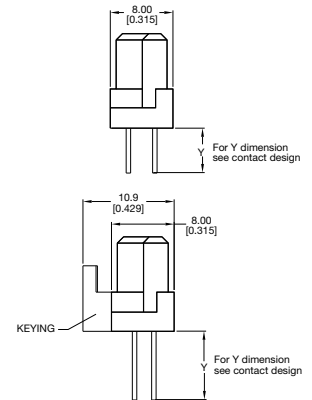
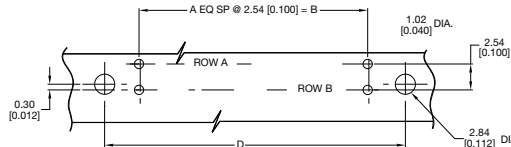
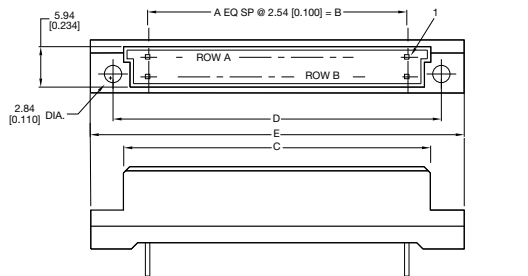

Unit: millimeters (inches)

No. Contact Positions	Contact Rows	A	B	C	D	E
32	2 (2 x 16)	15	38.10 (1.500)	44.30 (1.744)	49.99 (1.968)	54.91 (2.162)

# Male Style B

## Series 8457 – 2 rows (2 x 32)

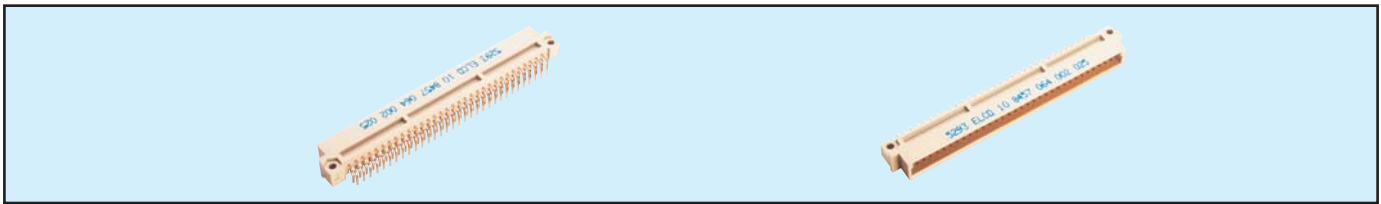

Contact Design and Termination Length	Number of Contacts	Loading Description	Part Number Performance classes according to DIN 41612	
3.4 mm (Y) Straight	64	a + b fully loaded	10 8457 064 001 025	10 8457 064 001 049
	32	a + b even loading	10 8457 064 001 031	10 8457 064 001 055
	32	a loading only	10 8457 064 001 027	10 8457 064 001 051
3.0 mm (Y) Right Angled	64	a + b fully loaded	10 8457 064 002 025	10 8457 064 002 049
	32	a + b even loading	10 8457 064 002 031	10 8457 064 002 055
	32	a loading only	10 8457 064 002 027	10 8457 064 002 051
13.0 mm (Y) Straight	64	a + b fully loaded	10 8457 064 003 025	10 8457 064 003 049
	32	a + b even loading	10 8457 064 003 031	10 8457 064 003 055
	32	a loading only	10 8457 064 003 027	10 8457 064 003 051
11.3 mm (Y) Right Angled	64	a + b fully loaded	10 8457 064 004 025	10 8457 064 004 049
	32	a + b even loading	10 8457 064 004 031	10 8457 064 004 055
	32	a loading only	10 8457 064 004 027	10 8457 064 004 051
2.3 mm (Y) Right Angled	64	a + b fully loaded	10 8457 064 008 025	10 8457 064 008 049
	32	a + b even loading	10 8457 064 008 031	10 8457 064 008 055
	32	a loading only	10 8457 064 008 027	10 8457 064 008 051
	62 + 2	fully loaded + ground	10 8457 064 102 025	10 8457 064 102 049
			10 8457 064 108 025	10 8457 064 108 049

NB: Alternative Prefix Variations Available: 12, 16 & 17, please refer to Page 10.  
Additional Plating & Loading Variations: Please contact your local AVX sales office or distributor.

### LOADING DESCRIPTION DIMENSIONS

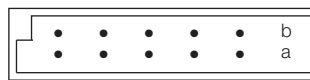

64 contacts, rows a + b fully loaded

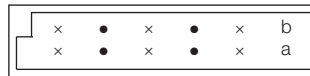

32 contacts, rows a + b even loading

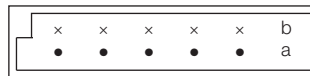

32 contacts, row a loading only

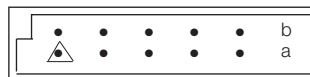

62 + 2 contacts, fully loaded with ground in A1 + A32

△ denotes ground pin

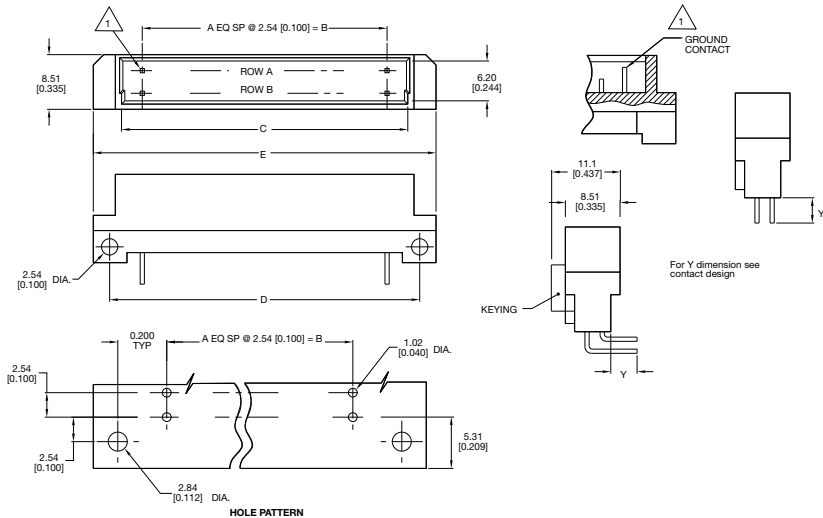

Unit: millimeters (inches)

No. Contact Positions	Contact Rows	A	B	C	D	E
64	2 (2 x 32)	31	78.74 (3.100)	85.19 (3.354)	88.90 (3.500)	93.98 (3.700)

# Female Style B



## Series 8457 – 2 rows (2 x 32)

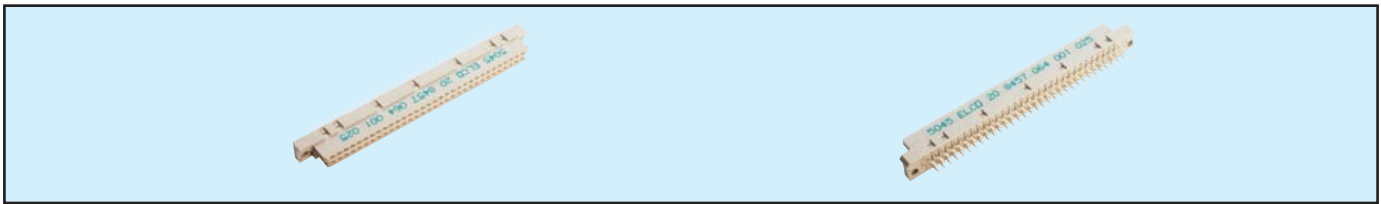

Contact Design and Termination Length	Number of Contacts	Loading Description	Part Number Performance classes according to DIN 41612	
			II	I
0.6 x 0.6 mm Post Profile 4.5 mm (Y) Straight	64	a + b fully loaded	20 8457 064 001 025	20 8457 064 001 049
	32	a + b even loading	20 8457 064 001 031	20 8457 064 001 055
	32	a loading only	20 8457 064 001 027	20 8457 064 001 051
0.6 x 0.6 mm Post Profile 2.9 mm (Y) Straight	64	a + b fully loaded	20 8457 064 002 025	20 8457 064 002 049
	32	a + b even loading	20 8457 064 002 031	20 8457 064 002 055
	32	a loading only	20 8457 064 002 027	20 8457 064 002 051
0.6 x 0.6 mm Post Profile 13.0 mm (Y) Straight	64	a + b fully loaded	20 8457 064 005 025	20 8457 064 005 049
	32	a + b even loading	20 8457 064 005 031	20 8457 064 005 055
	32	a loading only	20 8457 064 005 027	20 8457 064 005 051
0.6 x 0.6 mm Post Profile 7.0 mm (Y) Straight	64	a + b fully loaded	20 8457 064 010 025	20 8457 064 010 049
	32	a + b even loading	20 8457 064 010 031	20 8457 064 010 055
	32	a loading only	20 8457 064 010 027	20 8457 064 010 051
0.6 x 0.6 mm Post Profile 3.5 mm (Y) Straight	64	a + b fully loaded	20 8457 064 011 025	20 8457 064 011 049
	32	a + b even loading	20 8457 064 011 031	20 8457 064 011 055
	32	a loading only	20 8457 064 011 027	20 8457 064 011 051
0.6 x 0.6 mm Post Profile 19.4 mm (Y) Straight	64	a + b fully loaded	20 8457 064 012 025	20 8457 064 012 049
	32	a + b even loading	20 8457 064 012 031	20 8457 064 012 055
	32	a loading only	20 8457 064 012 027	20 8457 064 012 051
0.6 x 0.6 mm Post Profile 4.5 mm (Y) Right Angled	64	a + b fully loaded	20 8457 064 013 025	20 8457 064 013 049
	32	a + b even loading	20 8457 064 013 031	20 8457 064 013 055
	32	a loading only	20 8457 064 013 027	20 8457 064 013 051

NB: Alternative Prefix Variations Available: 22, 24, 25, 26 & 27, please refer to Page 10.  
Additional Plating & Loading Variations: Please contact your local AVX sales office or distributor.

### LOADING DESCRIPTION



64 contacts, rows a + b fully loaded

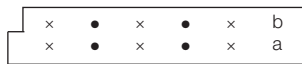

32 contacts, rows a + b even loading

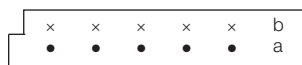

32 contacts, row a loading only

### DIMENSIONS

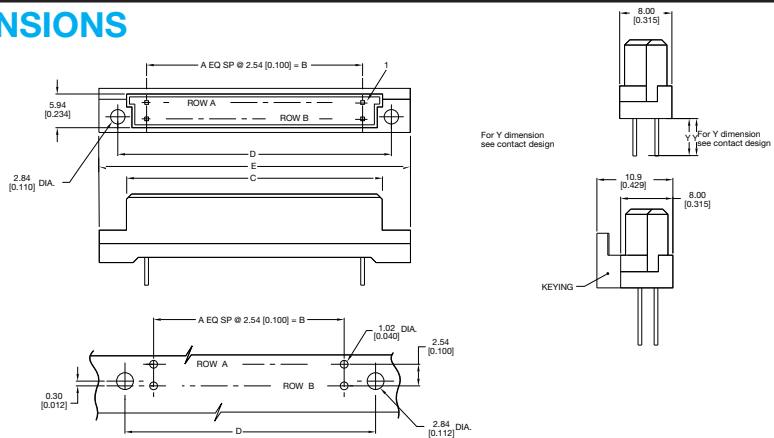

HOLE PATTERN

Unit: millimeters (inches)

No. Contact Positions	Contact Rows	A	B	C	D	E
64	2 (2 x 32)	31	78.74 (3.100)	84.91 (3.343)	89.99 (3.543)	94.89 (3.736)

# Male Style 1/3 C

## Series 8457 – 3 rows (3 x 10)



Contact Design and Termination Length	Number of Contacts	Loading Description	Part Number Performance classes according to DIN 41612	
			II	I
3.4 mm (Y) Straight	30	a + b + c fully loaded	10 8457 030 001 025	10 8457 030 001 049
	20	a + c fully loaded	10 8457 030 001 026	10 8457 030 001 050
3.0 mm (Y) Right Angled	30	a + b + c fully loaded	10 8457 030 002 025	10 8457 030 002 049
	20	a + c fully loaded	10 8457 030 002 026	10 8457 030 002 050
	28 + 2	fully loaded + ground	10 8457 030 102 025	10 8457 030 102 049
13.0 mm (Y) Straight	30	a + b + c fully loaded	10 8457 030 003 025	10 8457 030 003 049
	20	a + c fully loaded	10 8457 030 003 026	10 8457 030 003 050
11.3 mm (Y) Right Angled	30	a + b + c fully loaded	10 8457 030 004 025	10 8457 030 004 049
	20	a + c fully loaded	10 8457 030 004 026	10 8457 030 004 050
2.3 mm (Y) Right Angled	30	a + b + c fully loaded	10 8457 030 008 025	10 8457 030 008 049
	20	a + c fully loaded	10 8457 030 008 026	10 8457 030 008 050
	28 + 2	fully loaded + ground	10 8457 030 108 025	10 8457 030 108 049

NB: Alternative Prefix Variations Available: 12, 16 & 17, please refer to Page 10.  
Additional Plating & Loading Variations: Please contact your local AVX sales office or distributor.

### LOADING DESCRIPTION DIMENSIONS

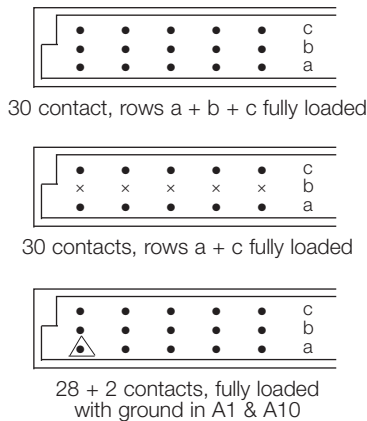

△ denotes ground pin

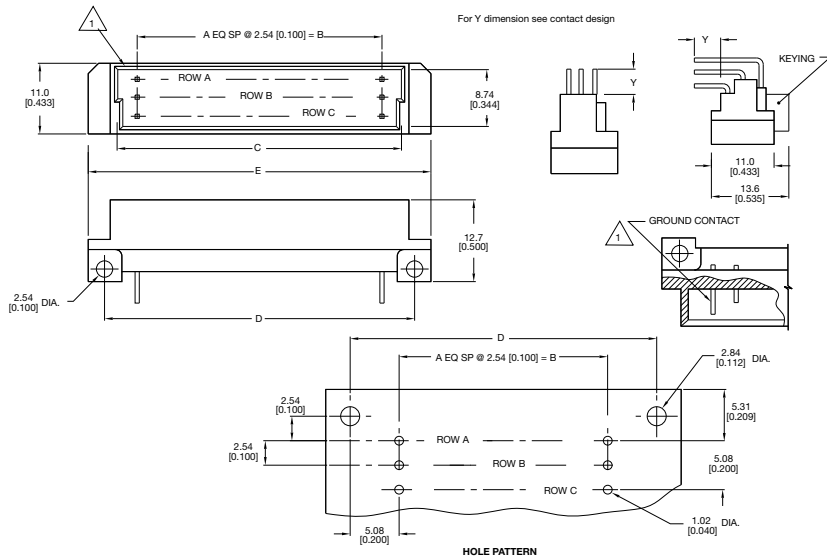

Unit: millimeters (inches)

No. Contact Positions	Contact Rows	A	B	C	D	E
30	3 (3 x 10)	9	22.86 (0.900)	29.41 (1.158)	33.02 (1.300)	38.02 (1.497)

# Female Style 1/3 C

## Series 8457 – 3 rows (3 x 10)

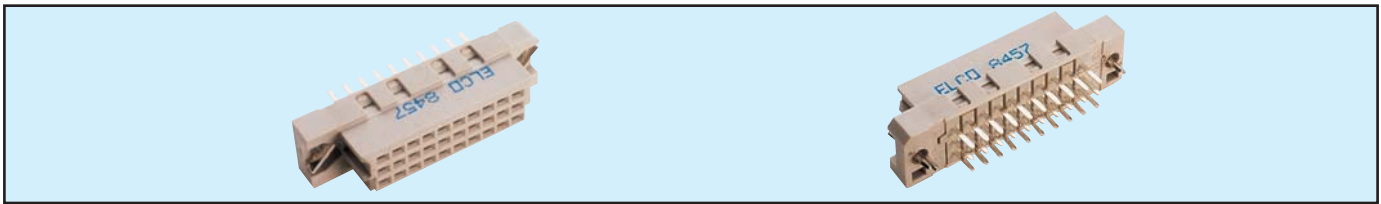

Contact Design and Termination Length	Number of Contacts	Loading Description	Part Number Performance classes according to DIN 41612	
			II	I
0.6 x 0.6 mm Post Profile 4.5 mm (Y) Straight	30	a + b + c fully loaded	20 8457 030 001 025	20 8457 030 001 049
	20	a + c fully loaded	20 8457 030 001 026	20 8457 030 001 050
0.6 x 0.6 mm Post Profile 2.9 mm (Y) Straight	30	a + b + c fully loaded	20 8457 030 002 025	20 8457 030 002 049
	20	a + c fully loaded	20 8457 030 002 026	20 8457 030 002 050
0.6 x 0.6 mm Post Profile 13.0 mm (Y) Straight	30	a + b + c fully loaded	20 8457 030 005 025	20 8457 030 005 049
	20	a + c fully loaded	20 8457 030 005 026	20 8457 030 005 050
0.6 x 0.6 mm Post Profile 3.5 mm (Y) Straight	30	a + b + c fully loaded	20 8457 030 011 025	20 8457 030 011 049
	20	a + c fully loaded	20 8457 030 011 026	20 8457 030 011 050
0.6 x 0.6 mm Post Profile 4.5 mm (Y) Right Angled	30	a + b + c fully loaded	20 8457 030 013 025	20 8457 030 013 049
	20	a + c fully loaded	20 8457 030 013 026	20 8457 030 013 050

NB: Alternative Prefix Variations Available: 22, 24, 25, 26 & 27, please refer to Page 10.  
Additional Plating & Loading Variations: Please contact your local AVX sales office or distributor.

### LOADING DESCRIPTION

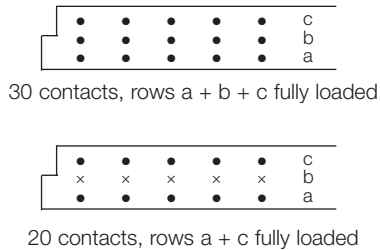

### DIMENSIONS

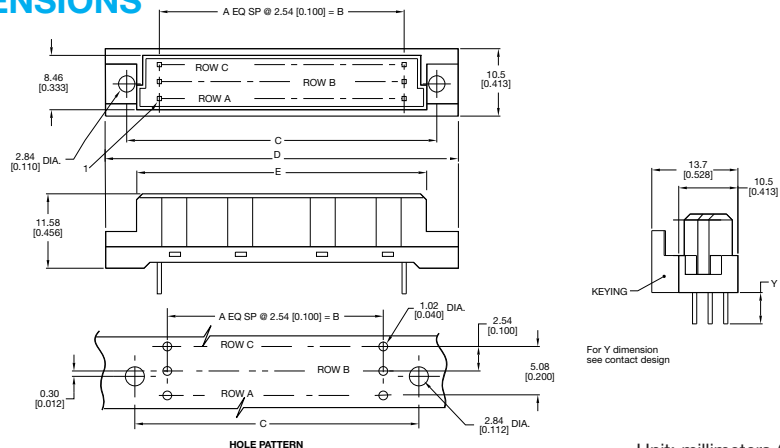

No. Contact Positions	Contact Rows	A	B	C	D	E
30	3 (3 x 10)	9	22.86 (0.900)	34.75 (1.368)	39.70 (1.563)	29.06 (1.144)

# Male Style 1/2 C



## Series 8457 – 3 rows (3 x 16)

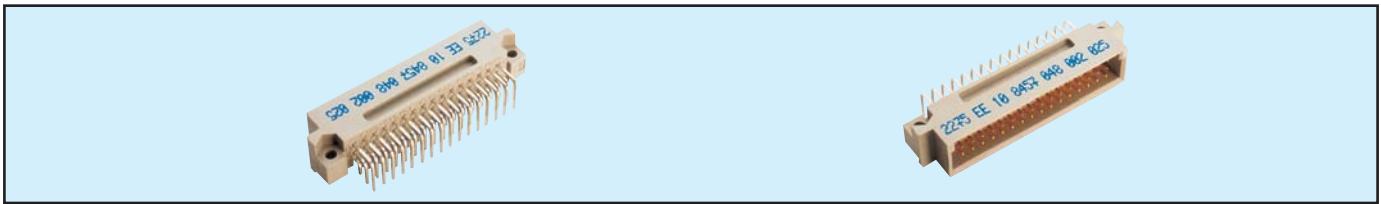

Contact Design and Termination Length	Number of Contacts	Loading Description	Part Number	
			Performance classes according to DIN 41612	
			II	I
3.4 mm (Y) Straight	48	a + b + c fully loaded	10 8457 048 001 025	10 8457 048 001 049
	32	a + c fully loaded	10 8457 048 001 026	10 8457 048 001 050
	16	a loading only	10 8457 048 001 027	10 8457 048 001 051
3.0 mm (Y) Right Angled	48	a + b + c fully loaded	10 8457 048 002 025	10 8457 048 002 049
	32	a + c fully loaded	10 8457 048 002 026	10 8457 048 002 050
	16	a loading only	10 8457 048 002 027	10 8457 048 002 051
	46 + 2	fully loaded + ground	10 8457 048 102 025	10 8457 048 102 049
13.0 mm (Y) Straight	48	a + b + c fully loaded	10 8457 048 003 025	10 8457 048 003 049
	32	a + c fully loaded	10 8457 048 003 026	10 8457 048 003 050
	16	a loading only	10 8457 048 003 027	10 8457 048 003 051
11.3 mm (Y) Right Angled	48	a + b + c fully loaded	10 8457 048 004 025	10 8457 048 004 049
	32	a + c fully loaded	10 8457 048 004 026	10 8457 048 004 050
	16	a loading only	10 8457 048 004 027	10 8457 048 004 051
2.3 mm (Y) Right Angled	48	a + b + c fully loaded	10 8457 048 008 025	10 8457 048 008 049
	32	a + c fully loaded	10 8457 048 008 026	10 8457 048 008 050
	16	a loading only	10 8457 048 008 027	10 8457 048 008 051
	46 + 2	fully loaded + ground	10 8457 048 108 025	10 8457 048 108 049

NB: Alternative Prefix Variations Available: 12, 16 & 17, please refer to Page 10.

Additional Plating & Loading Variations: Please contact your local AVX sales office or distributor.

### LOADING DESCRIPTION DIMENSIONS

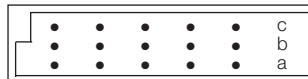

48 contacts, rows a + b + c fully loaded

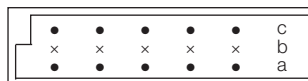

32 contacts, rows a + c fully loaded

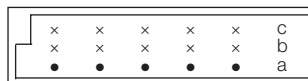

16 contacts, row a loading only

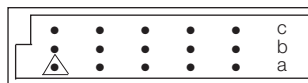

46 + 2 contacts, fully loaded with ground in A1 & A16

△ denotes ground pin

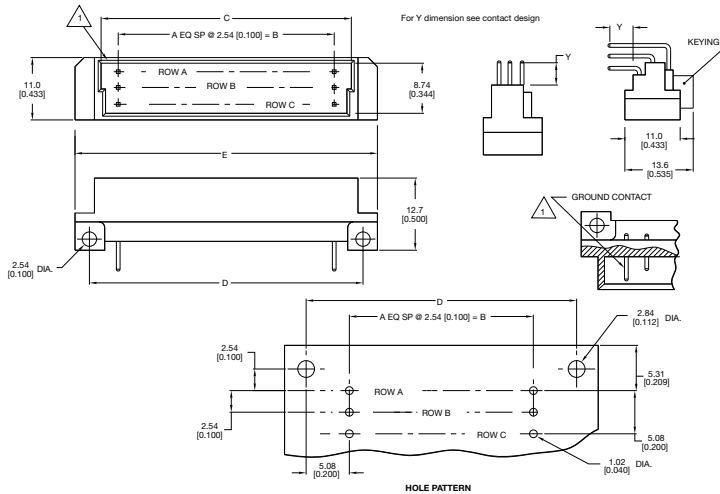

Unit: millimeters (inches)

No. Contact Positions	Contact Rows	A	B	C	D	E
48	3 (3 x 16)	15	38.10 (1.500)	44.70 (1.760)	48.26 (1.900)	53.90 (2.122)

# Female Style 1/2 C

## Series 8457 – 3 rows (3 x 16)

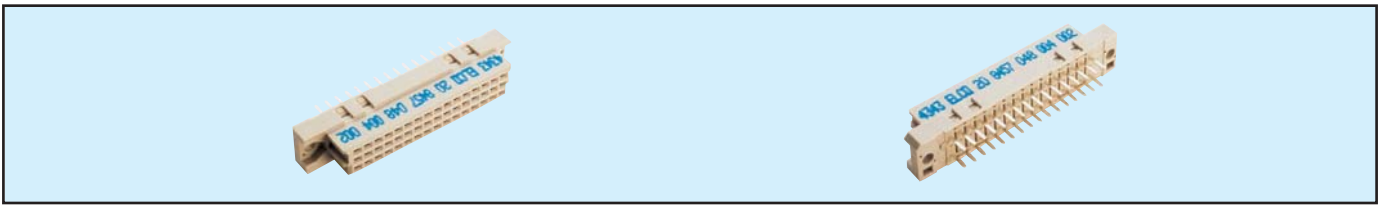

Contact Design and Termination Length	Number of Contacts	Loading Description	Part Number Performance classes according to DIN 41612	
			II	I
0.6 x 0.6 mm Post Profile 4.5 mm (Y) Straight	48	a + b + c fully loaded	20 8457 048 001 025	20 8457 048 001 049
	32	a + c fully loaded	20 8457 048 001 026	20 8457 048 001 050
	16	a loading only	20 8457 048 001 027	20 8457 048 001 051
0.6 x 0.6 mm Post Profile 2.9 mm (Y) Straight	48	a + b + c fully loaded	20 8457 048 002 025	20 8457 048 002 049
	32	a + c fully loaded	20 8457 048 002 026	20 8457 048 002 050
	16	a loading only	20 8457 048 002 027	20 8457 048 002 051
0.6 x 0.6 mm Post Profile 13.0 mm (Y) Straight	48	a + b + c fully loaded	20 8457 048 005 025	20 8457 048 005 049
	32	a + c fully loaded	20 8457 048 005 026	20 8457 048 005 050
	16	a loading only	20 8457 048 005 027	20 8457 048 005 051
0.6 x 0.6 mm Post Profile 7.0 mm (Y) Straight	48	a + b + c fully loaded	20 8457 048 010 025	20 8457 048 010 049
	32	a + c fully loaded	20 8457 048 010 026	20 8457 048 010 050
	16	a loading only	20 8457 048 010 027	20 8457 048 010 051
0.6 x 0.6 mm Post Profile 3.5 mm (Y) Straight	48	a + b + c fully loaded	20 8457 048 011 025	20 8457 048 011 049
	32	a + c fully loaded	20 8457 048 011 026	20 8457 048 011 050
	16	a loading only	20 8457 048 011 027	20 8457 048 011 051
0.6 x 0.6 mm Post Profile 19.4 mm (Y) Straight	48	a + b + c fully loaded	20 8457 048 012 025	20 8457 048 012 049
	32	a + c fully loaded	20 8457 048 012 026	20 8457 048 012 050
	16	a loading only	20 8457 048 012 027	20 8457 048 012 051
0.6 x 0.6 mm Post Profile 4.5 mm (Y) Right Angled	48	a + b + c fully loaded	20 8457 048 013 025	20 8457 048 013 049
	32	a + c fully loaded	20 8457 048 013 026	20 8457 048 013 050
	16	a loading only	20 8457 048 013 027	20 8457 048 013 051

NB: Alternative Prefix Variations Available: 22, 24, 25, 26 & 27, please refer to Page 10.  
Additional Plating & Loading Variations: Please contact your local AVX sales office or distributor.

### LOADING DESCRIPTION

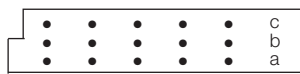

48 contacts, rows a + b + c fully loaded

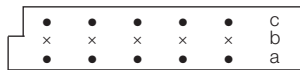

32 contacts, rows a + c fully loaded

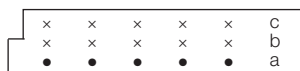

16 contacts, row a loading only

### DIMENSIONS

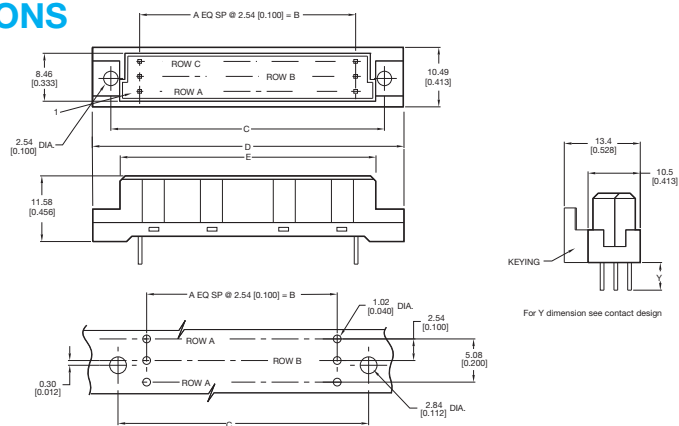

Unit: millimeters (inches)

No. Contact Positions	Contact Rows	A	B	C	D	E
48	3 (3 x 16)	15	38.10 (1.500)	50.01 (1.969)	54.89 (2.161)	44.30 (1.744)



# Male Style C



## Series 8457 – 3 rows (3 x 32)

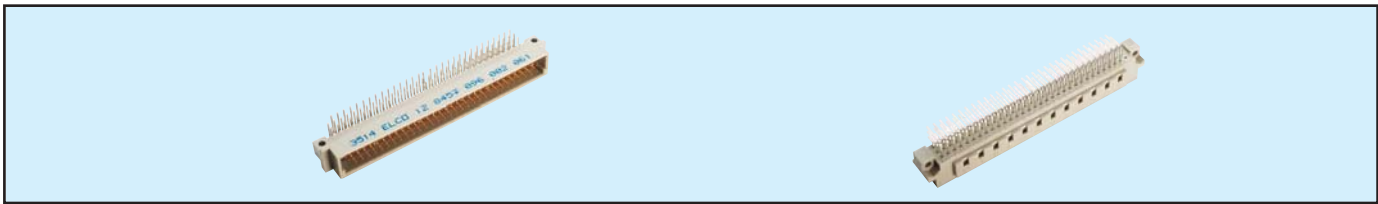

Contact Design and Termination Length	Number of Contacts	Loading Description	Part Number Performance classes according to DIN 41612	
			II	I
3.4 mm (Y) Straight	96	a + b + c fully loaded	10 8457 096 001 025	10 8457 096 001 049
	64	a + c fully loaded	10 8457 096 001 026	10 8457 096 001 050
	32	a + c even loading	10 8457 096 001 033	10 8457 096 001 057
	32	a loading only	10 8457 096 001 027	10 8457 096 001 051
3.0 mm (Y) Right Angled	96	a + b + c fully loaded	10 8457 096 002 025	10 8457 096 002 049
	64	a + c fully loaded	10 8457 096 002 026	10 8457 096 002 050
	32	a + c even loading	10 8457 096 002 033	10 8457 096 002 057
	32	a loading only	10 8457 096 002 027	10 8457 096 002 051
13.0 mm (Y) Straight	96	a + b + c fully loaded	10 8457 096 003 025	10 8457 096 003 049
	64	a + c fully loaded	10 8457 096 003 026	10 8457 096 003 050
	32	a + c even loading	10 8457 096 003 033	10 8457 096 003 057
	32	a loading only	10 8457 096 003 027	10 8457 096 003 051
11.3mm (Y) Right Angled	96	a + b + c fully loaded	10 8457 096 004 025	10 8457 096 004 049
	64	a + c fully loaded	10 8457 096 004 026	10 8457 096 004 050
	32	a + c even loading	10 8457 096 004 033	10 8457 096 004 057
	32	a loading only	10 8457 096 004 027	10 8457 096 004 051
7.7 mm (Y) Solder Hole	96	a + b + c fully loaded	10 8457 096 006 025	10 8457 096 006 049
	64	a + c fully loaded	10 8457 096 006 026	10 8457 096 006 050
	32	a + c even loading	10 8457 096 006 033	10 8457 096 006 057
	32	a loading only	10 8457 096 006 027	10 8457 096 006 051
6.4 mm (Y) Solder Loop	96	a + b + c fully loaded	10 8457 096 007 025	10 8457 096 007 049
	64	a + c fully loaded	10 8457 096 007 026	10 8457 096 007 050
	32	a + c even loading	10 8457 096 007 033	10 8457 096 007 057
	32	a loading only	10 8457 096 007 027	10 8457 096 007 051
2.3 mm (Y) Right Angled	96	a + b + c fully loaded	10 8457 096 008 025	10 8457 096 008 049
	64	a + c fully loaded	10 8457 096 008 026	10 8457 096 008 050
	32	a + c even loading	10 8457 096 008 033	10 8457 096 008 057
	32	a loading only	10 8457 096 008 027	10 8457 096 008 051

NB: Alternative Prefix Variations Available: 12, 16 & 17, please refer to Page 10.

Additional Plating & Loading Variations: Please contact your local AVX sales office or distributor.

### LOADING DESCRIPTION

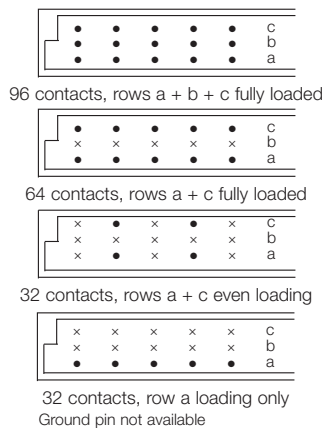

### DIMENSIONS

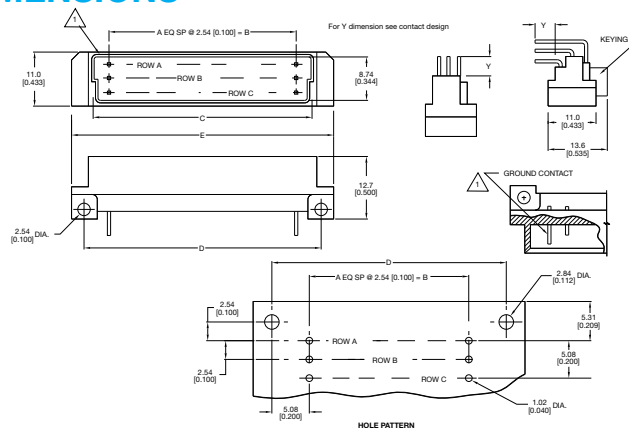

Unit: millimeters (inches)

No. Contact Positions	96
Contact Rows	3 (3 x 32)
A	31
B	78.74 (3.100)
C	85.29 (3.358)
D	88.90 (3.500)
E	93.90 (3.697)

# Female Style C

## Series 8457 – 3 rows (3 x 32)

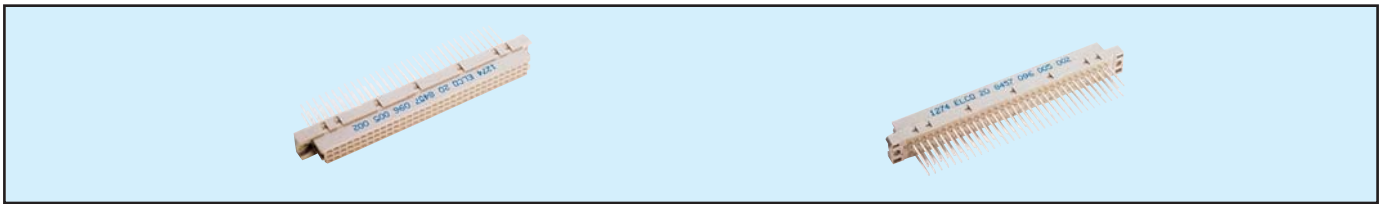

Contact Design and Termination Length	Number of Contacts	Loading Description	Part Number Performance classes according to DIN 41612	
			II	I
0.6 x 0.6 mm Post Profile 4.5 mm (Y) Straight	96	a + b + c fully loaded	20 8457 096 001 025	20 8457 096 001 049
	64	a + c fully loaded	20 8457 096 001 026	20 8457 096 001 050
	32	a + c even loading	20 8457 096 001 033	20 8457 096 001 057
	32	a loading only	20 8457 096 001 027	20 8457 096 001 051
0.6 x 0.6 mm Post Profile 2.9 mm (Y) Straight	96	a + b + c fully loaded	20 8457 096 002 025	20 8457 096 002 049
	64	a + c fully loaded	20 8457 096 002 026	20 8457 096 002 050
	32	a + c even loading	20 8457 096 002 033	20 8457 096 002 057
	32	a loading only	20 8457 096 002 027	20 8457 096 002 051
0.6 x 0.6 mm Post Profile 13.0 mm (Y) Straight	96	a + b + c fully loaded	20 8457 096 005 025	20 8457 096 005 049
	64	a + c fully loaded	20 8457 096 005 026	20 8457 096 005 050
	32	a + c even loading	20 8457 096 005 033	20 8457 096 005 057
	32	a loading only	20 8457 096 005 027	20 8457 096 005 051
0.6 x 0.6 mm Post Profile 7.0 mm (Y) Straight	96	a + b + c fully loaded	20 8457 096 010 025	20 8457 096 010 049
	64	a + c fully loaded	20 8457 096 010 026	20 8457 096 010 050
	32	a + c even loading	20 8457 096 010 033	20 8457 096 010 057
	32	a loading only	20 8457 096 010 027	20 8457 096 010 051
0.6 x 0.6 mm Post Profile 3.5 mm (Y) Straight	96	a + b + c fully loaded	20 8457 096 011 025	20 8457 096 011 049
	64	a + c fully loaded	20 8457 096 011 026	20 8457 096 011 050
	32	a + c all even loading	20 8457 096 011 033	20 8457 096 011 057
	32	a loading only	20 8457 096 011 027	20 8457 096 011 051
0.6 x 0.6 mm Post Profile 19.4 mm (Y) Straight	96	a + b + c fully loaded	20 8457 096 012 025	20 8457 096 012 049
	64	a + c fully loaded	20 8457 096 012 026	20 8457 096 012 050
	32	a + c even loading	20 8457 096 012 033	20 8457 096 012 057
	32	a loading only	20 8457 096 012 027	20 8457 096 012 051
0.6 x 0.6 mm Post Profile 4.5 mm (Y) Right Angled	96	a + b + c fully loaded	20 8457 096 013 025	20 8457 096 013 049
	64	a + c fully loaded	20 8457 096 013 026	20 8457 096 013 050
	32	a + c even loading	20 8457 096 013 033	20 8457 096 013 057
	32	a loading only	20 8457 096 013 027	20 8457 096 013 051

NB: Alternative Prefix Variations Available: 22, 24, 25, 26 & 27, please refer to Page 10.  
Additional Plating & Loading Variations: Please contact your local AVX sales office or distributor.

### LOADING DESCRIPTION

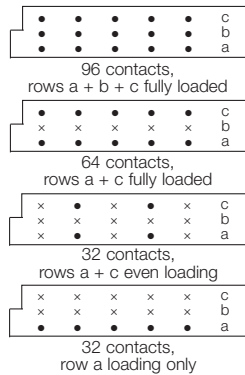

### DIMENSIONS

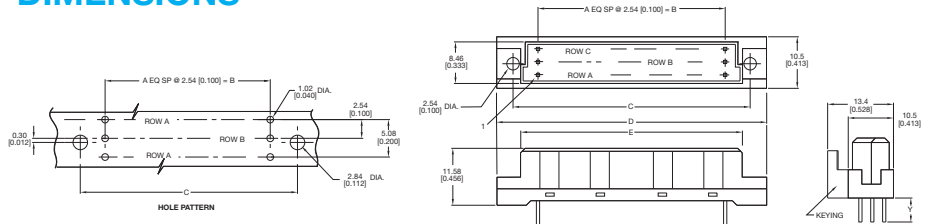

No. Contact Positions	Contact Rows	A	B	C	D	E
96	3 (3 x 32)	31	78.74 (3.100)	89.99 (3.543)	94.89 (3.736)	84.91 (3.343)

# Male Style C Expanded



## Series 8457 – 4 rows (4 x 32)

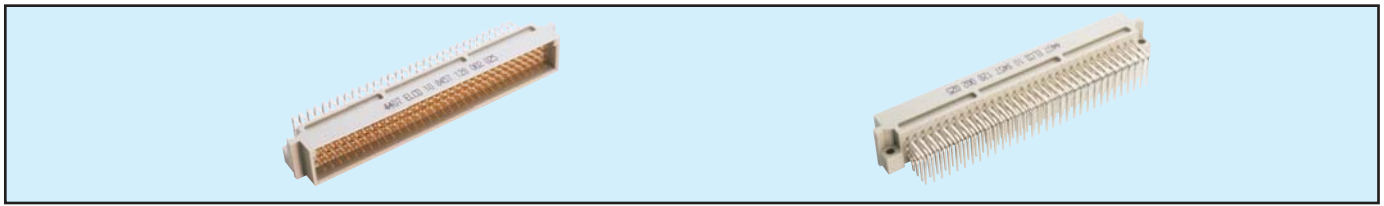

Contact Design and Termination Length	Number of Contacts	Loading Description	Part Number Performance classes according to DIN 41612	
			II	I
3.4 mm (Y) Straight	128	a + b + c + d fully loaded	10 8457 128 001 025	10 8457 128 001 049
	126 + 2	4 rows fully loaded + ground	10 8457 128 101 025	10 8457 128 101 049
3.0 mm (Y) Right Angled	128	a + b + c + d fully loaded	10 8457 128 002 025	10 8457 128 002 049
	126 + 2	4 rows fully loaded + ground	10 8457 128 102 025	10 8457 128 102 049

NB: Alternative Prefix Variations Available: 12, 16 & 17, please refer to Page 10.  
Additional Plating & Loading Variations: Please contact your local AVX sales office or distributor.

### LOADING DESCRIPTION

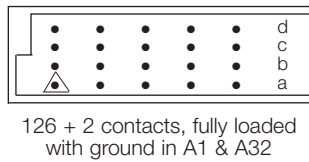
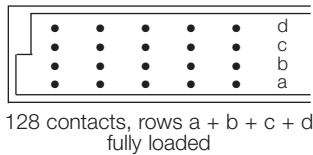

△ denotes ground pin

### DIMENSIONS

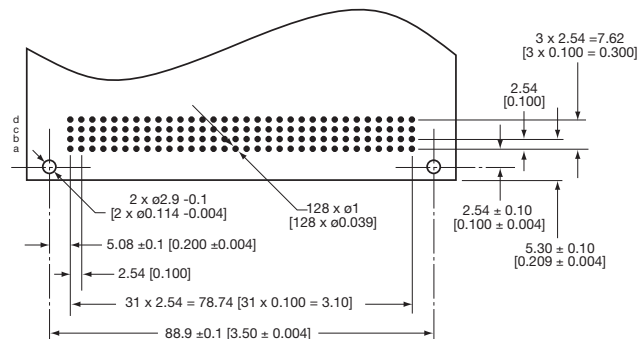
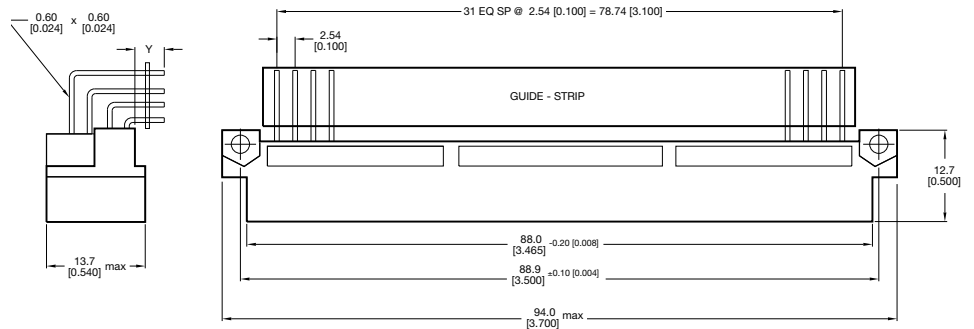

HOLE PATTERN