

1092 Series LED Panel Mount Indicators Wire Leads

Available in four different lens styles, three diffused lens colors and operating voltage range of 12V, 28V and 125V
Snap fit into 0.500" (12.7mm) panel hole diameter



Applications

- Industrial
- Transportation
- Food Service
- People Movers
- Medical
- Maritime
- Oil and Gas Industry
- Manufacturing
- Automation & Control

Key Features

- Snaps fit into 0.500" (12.7mm) panel hole
- LED illumination
- Four different lens styles available: Hi Hat, Hi Dome, Semi Dome and Small Dome
- Front-panel mount
- Front panel snap-in mounting requires no additional hardware
- Life expectancy of 100,000 hours
- High brightness LEDs for daylight viewing
- UL/cUL Listed. File Number E20356
- Order speed nuts separately to provide maximum fastening power with minimal installation torque.
- Order gasket separately to provide water, oil, air and dust tight.
- 4.4"/4.8" wire leads
- 0.187" (4.75mm) tab terminal version also available
- Available in wide operating voltage of 12V, 28V and 125V
- Three colors available: Red, Green, Amber
- Transparent and clear lenses provide visibility during the daylight
- Solution to retrofit: save energy and reduce the costs
- 'D' mounting hole aids anti-rotation
- Compliant with RoHS and REACH requirements
- For customized options, please contact us

Ordering Data

The 1092 Series is available in a range of standard features and options. To specify your Panel Mount Indicator, simply choose one option from each column. An example is shown below

Series	Lens Style	Color	Voltage
1092			-
Hi-Dome	A		12V
Hi-Hat	C		28V
Semi-Dome	D		125VAC
Small-Dome	M		
			luminous intensity (Typ)
Red	1	13,000 mcd	
Amber	3	13,000 mcd	
Green	5	12,000 mcd	

Example: 1092A5-12V
1092 with Hi-Dome lens - Green LED and 12 Volts



Accessories Ordering Data [order separately]

Speed Nut: SN0461-C



O'Ring Gasket: SPC472



Product Dimensions

Hi Dome

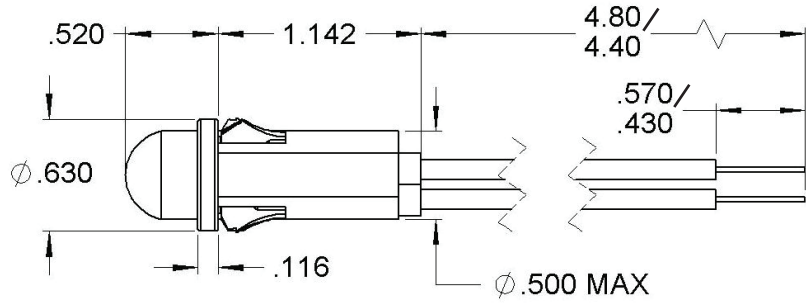
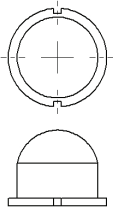

Hi Hat

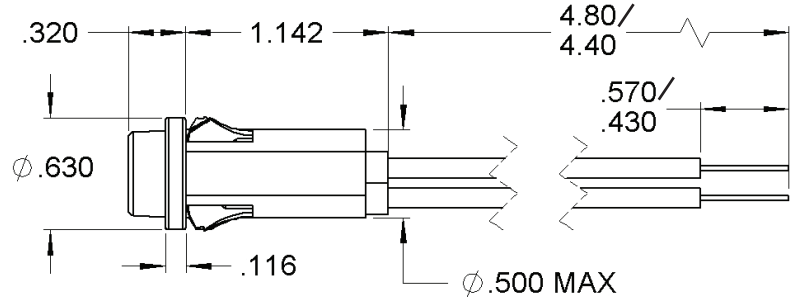
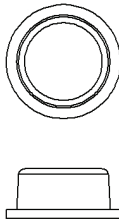

Semi Dome

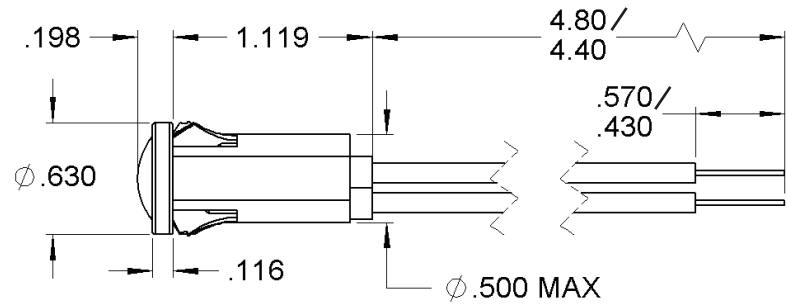
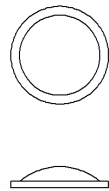

Small Dome

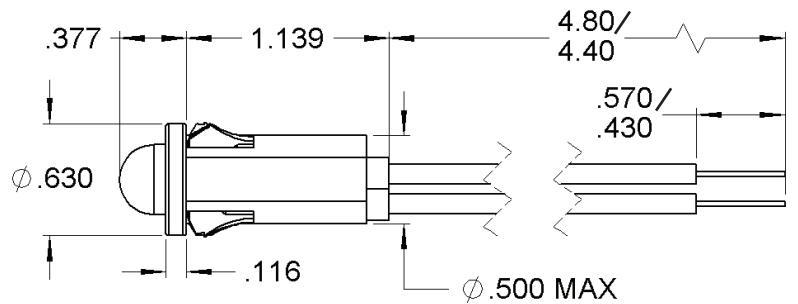
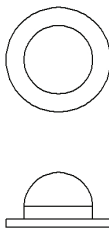

Mounting Hole (All)

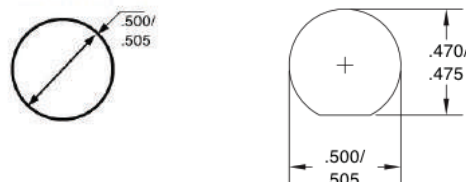

Standard Mounting Hole

D-Mounting Hole

Dimensions in inches

Product Specifications

Materials	
Housing	White Nylon UL94 V-2
Lens	Transparent Polycarbonate UL94 V-2
Bezel	Polished stainless steel
Wire Leads	Tinned Copper Conductor PVC Insulation

Voltage Table		
Nominal	VAC	VDC
12V	10 to 14	10 to 14
28V	26 to 30	26 to 30
125V	105 to 125	—

Temperature Specifications	
Operating Temperature	-40°C to +85°C -40°F to +185°F
Storage Temperature	-40°C to +85°C -40°F to +185°F

Installation Specifications	
Mounting Hole	0.500" to 0.505" (12.70 to 12.83 mm)
D-Mounting Hole	0.470" to 0.475" (11.94 to 12.07 mm)
Panel Thickness	0.020" to 0.100" (0.51 to 2.54 mm)
Wire Leads	18 AWG -105°C - 600V lead color: red and black, 4.40"/4.80" (111.8/121.9 mm) long, stripped .430"/.570" (10.9/14.5 mm) Anode(+): Red lead

Internal Resistor	
12V	390Ω
28V	1200Ω
125V	15000Ω + rectifier diode
Forward Current Rating	25mA

Accessory options [order separately]

O-Ring Gasket

Part Number **SPC472**

The 1092 Gasket is designed to seal many types of media, including water, air, dust, and oil. The panel gasket is intended to provide a seal between the panel and the 1092 Panel Mount Indicator.

Meets ASTM D2000 standard.

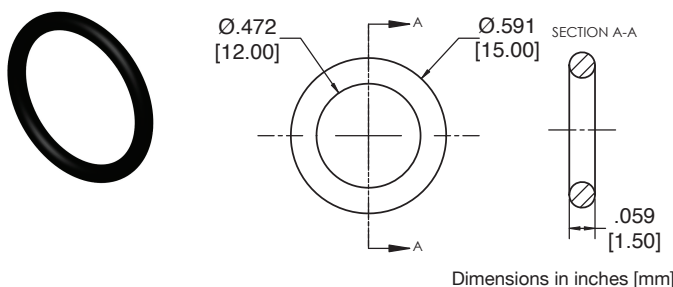

Material	
Buna-N, Durometer A50, black	
Installation Specification	
Internal Diameter	0.472" (12 mm)
Thickness	0.059" (1.5 mm)
Operational Temperature	-30°F to +225°F