



GaAs PHEMT MMIC MEDIUM POWER AMPLIFIER, 17.5 - 25.5 GHz

Typical Applications

The HMC442LC3B is an ideal gain block or driver amplifier for:

- Point-to-Point Radios
- Point-to-Multi-Point Radios
- LO Driver for HMC Mixers
- Military EW & ECM

Features

- Gain: 13 dB
- Saturated Power: +23 dBm @ 26% PAE
- Supply Voltage: +5V
- 50 Ohm Matched Input/Output
- RoHS Compliant 3 x 3 mm SMT package

Functional Diagram

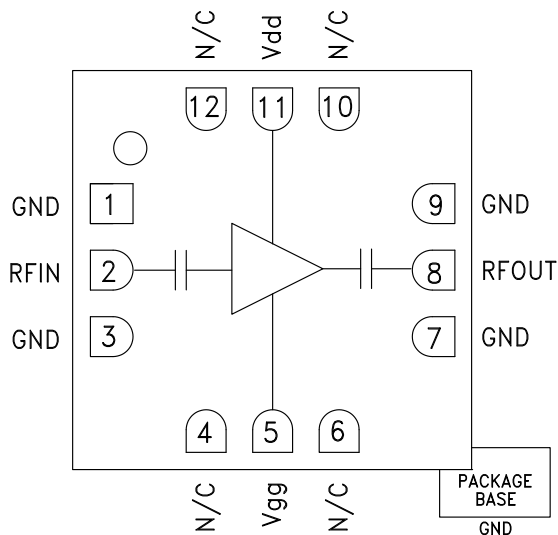

General Description

The HMC442LC3B is an efficient GaAs PHEMT MMIC Medium Power Amplifier housed in a leadless "Pb free" RoHS compliant SMT package. Operating between 17.5 and 25.5 GHz, the amplifier provides 13 dB of gain, +23 dBm of saturated power and 26% PAE from a +5V supply voltage. This 50 Ohm matched amplifier does not require any external components, making it an ideal linear gain block or driver for HMC SMT mixers. The HMC442LC3B allows the use of surface mount manufacturing techniques.

Electrical Specifications, $T_A = +25^\circ C$, $V_{dd} = +5V$, $I_{dd} = 84 mA^*$

Parameter	Min.	Typ.	Max.	Min.	Typ.	Max.	Min.	Typ.	Max.	Units
Frequency Range	17.5 - 21.0			21.0 - 24.0			24.0 - 25.5			GHz
Gain	10	13		10	13		8	11		dB
Gain Variation Over Temperature		0.02	0.03		0.02	0.03		0.02	0.03	dB/°C
Input Return Loss		10			10			5		dB
Output Return Loss		9			9			12		dB
Output Power for 1 dB Compression (P1dB)	18	21		19	22		19	22		dBm
Saturated Output Power (P _{sat})		23			23.5			23		dBm
Output Third Order Intercept (IP ₃)		27			26			26		dBm
Noise Figure		8			8			9		dB
Supply Current (I _{dd})(V _{dd} = 5V, V _{gg} = -1V Typ.)		84			84			84		mA

*Adjust V_{gg} between -1.5 to -0.5V to achieve I_{dd} = 84 mA typical.



**GaAs PHEMT MMIC MEDIUM
POWER AMPLIFIER, 17.5 - 25.5 GHz**

Broadband Gain & Return Loss

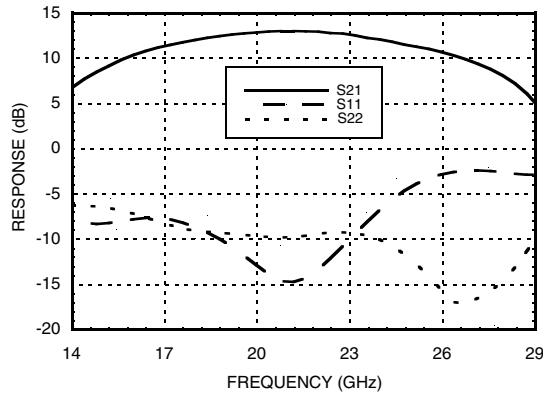

Gain vs. Temperature

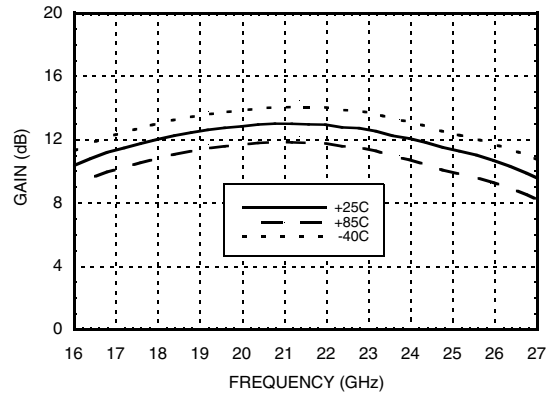

Input Return Loss vs. Temperature

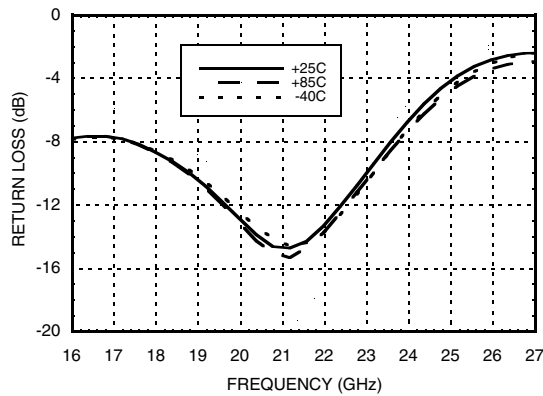

Output Return Loss vs. Temperature

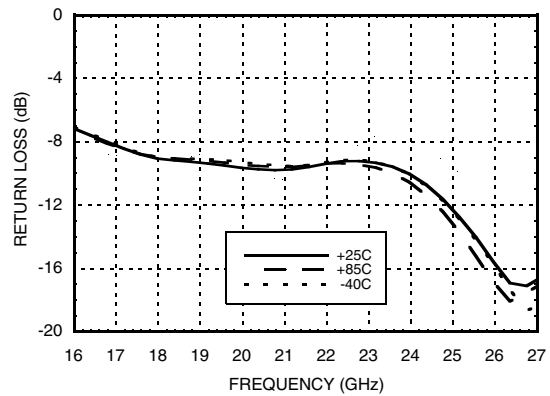

P1dB vs. Temperature

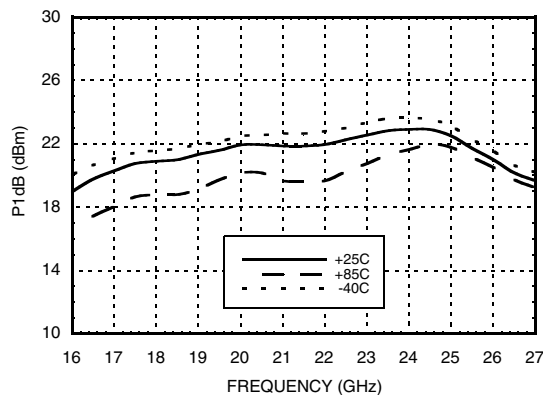

Psat vs. Temperature

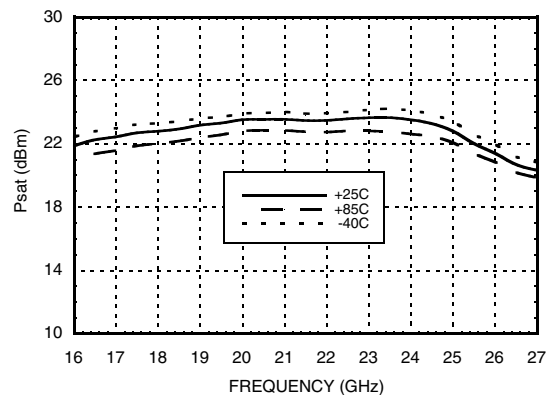

Information furnished by Analog Devices is believed to be accurate and reliable. However, no responsibility is assumed by Analog Devices for its use, nor for any infringements of patents or other rights of third parties that may result from its use. Specifications subject to change without notice. No license is granted by implication or otherwise under any patent or patent rights of Analog Devices. Trademarks and registered trademarks are the property of their respective owners.

For price, delivery, and to place orders: Analog Devices, Inc., One Technology Way, P.O. Box 9106, Norwood, MA 02062-9106 Phone: 781-329-4700 • Order online at www.analog.com Application Support: Phone: 1-800-ANALOG-D



GaAs PHEMT MMIC MEDIUM POWER AMPLIFIER, 17.5 - 25.5 GHz

LINEAR & POWER AMPLIFIERS - SMT

Power Compression @ 18 GHz

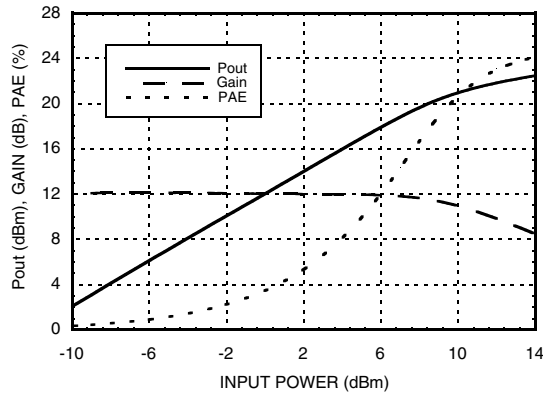

Power Compression @ 23 GHz

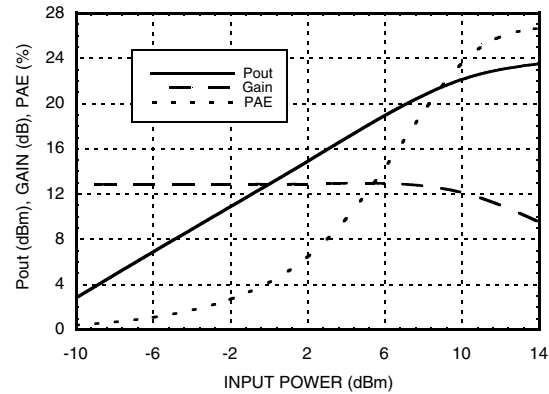

Output IP3 vs. Temperature

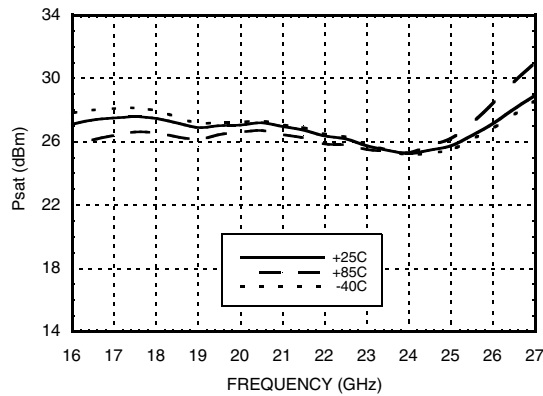

Noise Figure vs. Temperature

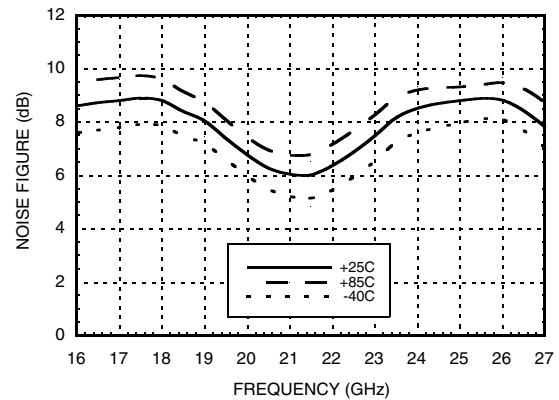

Gain, Power and Output IP3 vs. Supply Voltage @ 23 GHz

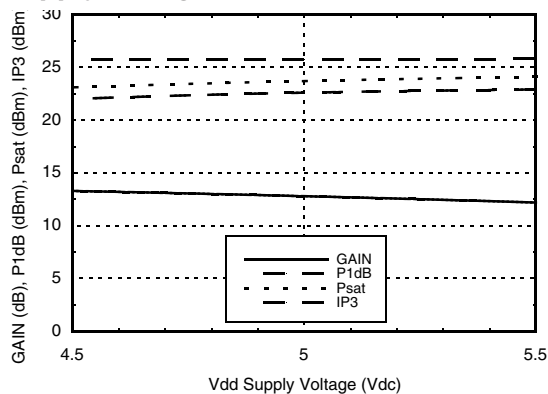

Reverse Isolation vs. Temperature

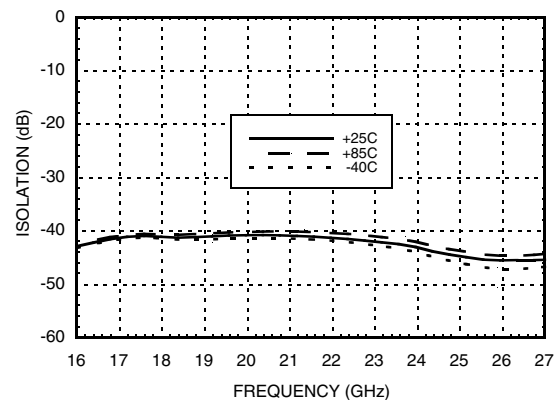

Information furnished by Analog Devices is believed to be accurate and reliable. However, no responsibility is assumed by Analog Devices for its use, nor for any infringements of patents or other rights of third parties that may result from its use. Specifications subject to change without notice. No license is granted by implication or otherwise under any patent or patent rights of Analog Devices. Trademarks and registered trademarks are the property of their respective owners.

For price, delivery, and to place orders: Analog Devices, Inc., One Technology Way, P.O. Box 9106, Norwood, MA 02062-9106 Phone: 781-329-4700 • Order online at www.analog.com Application Support: Phone: 1-800-ANALOG-D



GaAs PHEMT MMIC MEDIUM POWER AMPLIFIER, 17.5 - 25.5 GHz

Absolute Maximum Ratings

Drain Bias Voltage (Vdd)	+5.5 Vdc
Gate Bias Voltage (Vgg)	-8.0 to 0 Vdc
RF Input Power (RFIN)(Vdd = +5Vdc, Idd = 85 mA)	+16 dBm
Channel Temperature	175 °C
Continuous Pdiss (T = 85 °C) (derate 5.46 mW/°C above 85 °C)	0.491 W
Thermal Resistance (channel to ground paddle)	183 °C/W
Storage Temperature	-65 to +150 °C
Operating Temperature	-40 to +85 °C
ESD Sensitivity (HBM)	Class 1A

Typical Supply Current vs. Vdd

Vdd (V)	Idd (mA)
+4.5	82
+5.0	84
+5.5	86

Note: Amplifier will operate over full voltage range shown above



**ELECTROSTATIC SENSITIVE DEVICE
OBSERVE HANDLING PRECAUTIONS**

Outline Drawing

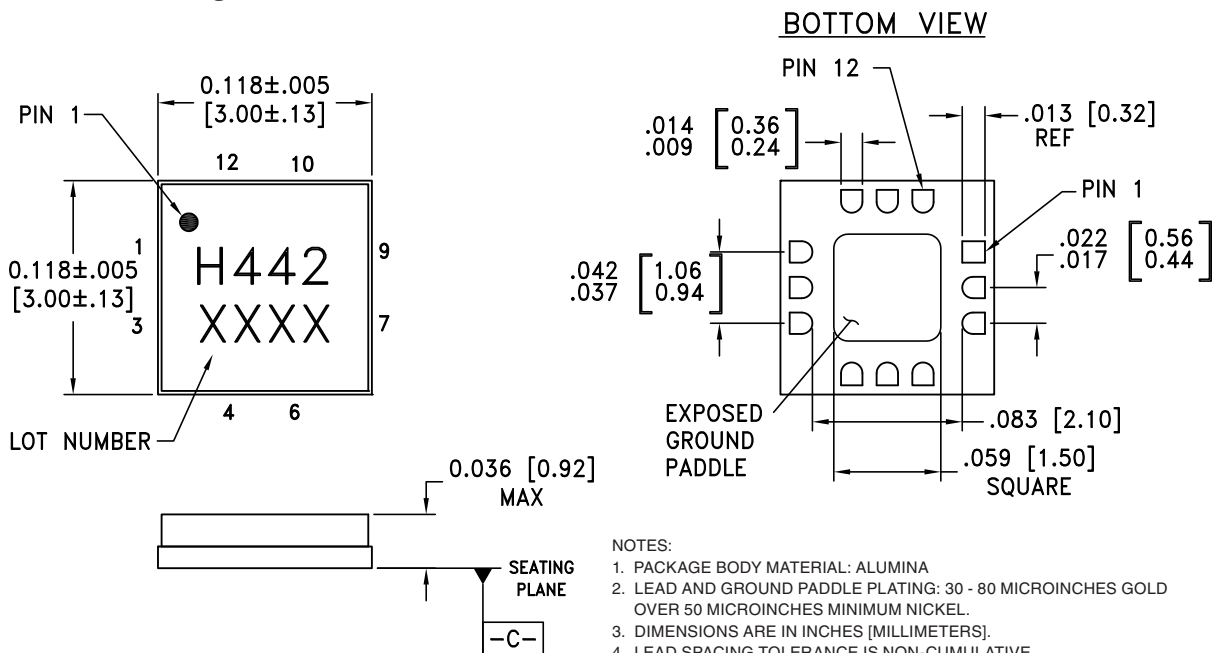

NOTES:

1. PACKAGE BODY MATERIAL: ALUMINA
2. LEAD AND GROUND PADDLE PLATING: 30 - 80 MICROINCHES GOLD OVER 50 MICROINCHES MINIMUM NICKEL.
3. DIMENSIONS ARE IN INCHES [MILLIMETERS].
4. LEAD SPACING TOLERANCE IS NON-CUMULATIVE
5. PACKAGE WARP SHALL NOT EXCEED 0.05mm DATUM -C-
6. ALL GROUND LEADS AND GROUND PADDLE MUST BE SOLDERED TO PCB RF GROUND.

Package Information

Part Number	Package Body Material	Lead Finish	MSL Rating	Package Marking ^[2]
HMC442LC3B	Alumina, White	Gold over Nickel	MSL3 ^[1]	H442 XXXX

[1] Max peak reflow temperature of 260 °C

[2] 4-Digit lot number XXXX



**GaAs PHEMT MMIC MEDIUM
POWER AMPLIFIER, 17.5 - 25.5 GHz**

Pin Descriptions

Pin Number	Function	Description	Interface Schematic
1, 3, 7, 9	GND	Package bottom must also be connected to RF/DC ground	
2	RFIN	This pin is AC coupled and matched to 50 Ohms.	
4, 6, 10, 12	N/C	This pin may be connected to RF/DC ground. Performance will not be affected.	
5	Vgg	Gate control for amplifier. Adjust to achieve Id of 84 mA. Please follow "MMIC Amplifier Biasing Procedure" Application Note.	
8	RFOUT	This pin is AC coupled and matched to 50 Ohms.	
11	Vdd	Power Supply Voltage for the amplifier. External bypass capacitors are required.	

Application Circuit

Component	Value
C1, C2	100 pF
C3, C4	1,000 pF
C5, C6	2.2 μF

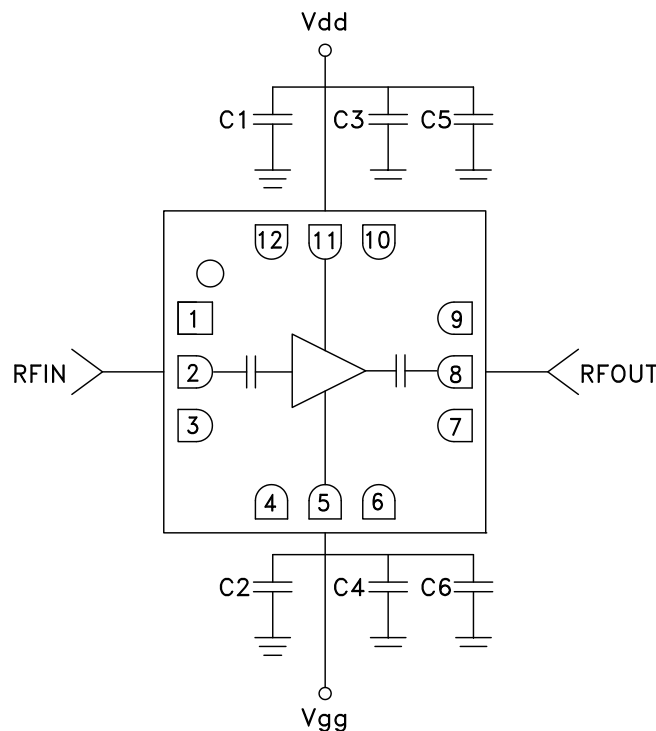

Information furnished by Analog Devices is believed to be accurate and reliable. However, no responsibility is assumed by Analog Devices for its use, nor for any infringements of patents or other rights of third parties that may result from its use. Specifications subject to change without notice. No license is granted by implication or otherwise under any patent or patent rights of Analog Devices. Trademarks and registered trademarks are the property of their respective owners.

For price, delivery, and to place orders: Analog Devices, Inc., One Technology Way, P.O. Box 9106, Norwood, MA 02062-9106 Phone: 781-329-4700 • Order online at www.analog.com Application Support: Phone: 1-800-ANALOG-D