

# Power Thermistor (= Inrush Current Limiter) Series

## POWER THERMISTOR

NTC thermistors heat up when a current passes through them. The heat up then causes a dramatic decrease in resistance. This effect is used by SEMITEC's power thermistor series to suppress inrush currents. Circuits including for example electric bulbs or capacitors induce an inrush current of more than 100 times the normal current when the circuit is switched on. SEMITEC's power thermistors suppress this inrush current and thereby protect electric equipment from damage.

### Applications

Switch circuits, adapters, LCD TVs, plasma TVs, air conditioners, DVD players, audio equipment, LCD projectors, copy machines, PCs, printers, office automation, slot machines and many more

### How to use power thermistors

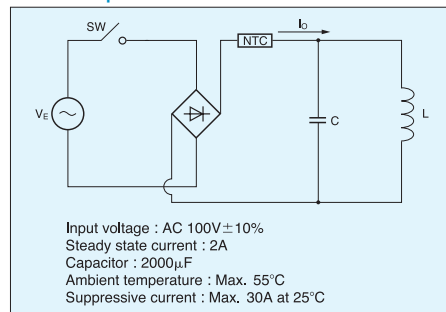

A suitable power thermistor for the above circuit is required to fulfill the following terms and conditions.

1. The permissible current at an ambient temperature of 55°C should be over 2A.
2. The thermistor resistance for the suppressed current should be higher than 4.2 ohm when below 30A according to the formula below.

$$\frac{\sqrt{2} V_E \times 1.1}{R_C + R_{25}} \leq 30$$

$R_C$  : Internal resistance value in the circuit is 1 ohm (100V/100A)

$R_{25}$  : Rated zero-power resistance at 25°C

3. Max. capacitance shall be over 2000µF at AC 100V.

Accordingly, for this example suitable thermistors are 6D2-22, 5D2-18 and 8D2-18.

In cases where a quick response time (= small thermal time constant) is needed a small size / large effect (= large rated zero-power resistance) power thermistor such as the 8D2-18 is advantageous.

Use below circuit for power supplies of 100V and 200V.

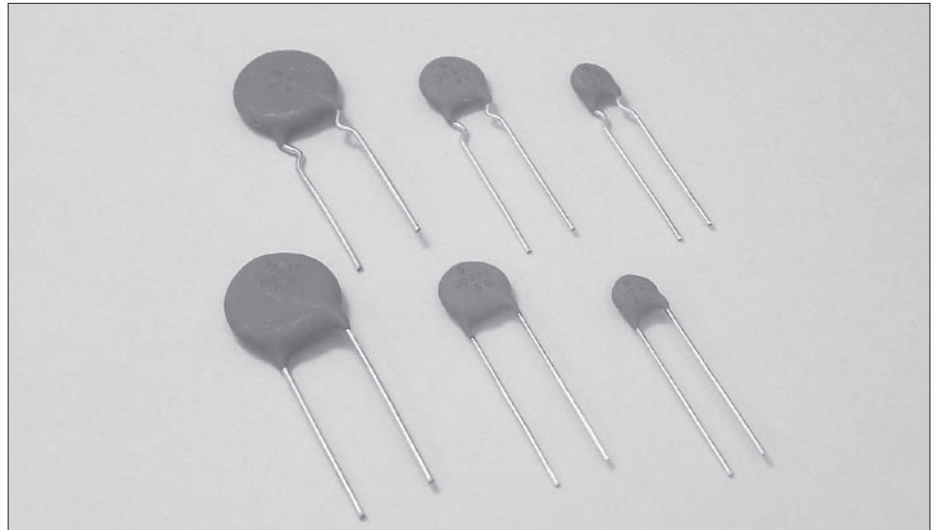
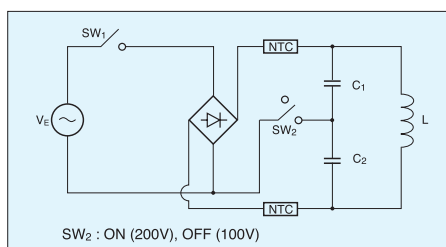

### Thermal time constant

The temperature of a thermistor generally changes slowly, even if the ambient temperature is changed rapidly from T1 to T2.

The "thermal time constant" describes the time necessary until the thermistor reaches 63.2% of the temperature difference.

### Residual resistance

If a current flows through a thermistor it heats up and resistance decreases. However, the resistance is stabilized at a saturation resistance value which is determined by the impressed electric power and the thermistor's dissipation factor.

The "residual resistance" value describes the maximum resistance value for the maximum permissible current.

### Temperature coefficient $\alpha$

The temperature coefficient of a thermistor is expressed by the following equation:

$$\alpha = -\frac{B}{T^2} \times 100 (\% / ^\circ\text{C})$$

### Dissipation factor

If a small voltage is applied to a thermistor, then a corresponding small current will flow and cause the thermistor to heat up.

The "dissipation factor" describes the electric power value which leads to an increase of the thermistor's temperature by 1°C.

$$\delta = \frac{P}{\Delta t} (\text{mW} / ^\circ\text{C})$$

P is the applied electric power.

$\Delta t$  is the temperature increase of the thermistor.

### Maximum permissible current

The maximum permissible current describes the current value which increases the temperature of the thermistor to 200°C (Version 2) and 160°C (Version 1) respectively at an ambient temperature of 25°C. When the ambient temperature is higher than 25°C then the maximum permissible current is reduced as per the table below.

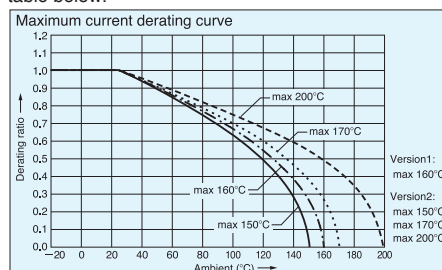

### Reliability tests

#### Version1

##### Dry heat test

Test sample is exposed to an air temperature of 160°C for 1,000 hours.  $\Delta R_{25}/R_{25} \pm 15\%$

##### High humidity heat test

Test sample is exposed to a humidity of 95%RH at 40°C for 1,000 hours.  $\Delta R_{25}/R_{25} \pm 15\%$

##### Load test

Test sample is exposed to the maximum rating current at an ambient temperature of 25°C for 1,000 hours.  $\Delta R_{25}/R_{25} \pm 15\%$

##### Temperature cycle

Test samples is subjected to the following temperature cycle (10 times):

→ 40°C for 30 minutes → room temperature for 5 minutes

→ 160°C for 30 minutes

→ room temperature for 5 minutes

$\Delta R_{25}/R_{25} \pm 15\%$

#### Version2

##### Dry heat test

Test sample is exposed to an air temperature of 150°C~200°C for 1,000 hours.  $\Delta R_{25}/R_{25} \pm 20\%$

##### High humidity heat test

Test sample is exposed to a humidity of 95%RH at 40°C for 1,000 hours.  $\Delta R_{25}/R_{25} \pm 15\%$

##### Load test

Test sample is exposed to the maximum rating current at an ambient temperature of 25°C for 1,000 hours.  $\Delta R_{25}/R_{25} \pm 20\%$

##### Temperature cycle

Test samples is subjected to the following temperature cycle (10 times):

→ 40°C for 30 minutes → room temperature for 5 minutes

→ 160°C for 30 minutes

→ room temperature for 5 minutes

$\Delta R_{25}/R_{25} \pm 15\%$

**Part number**

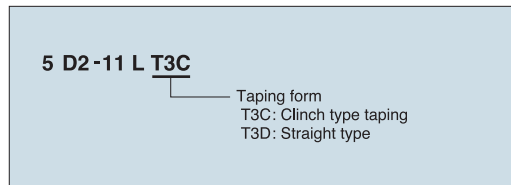
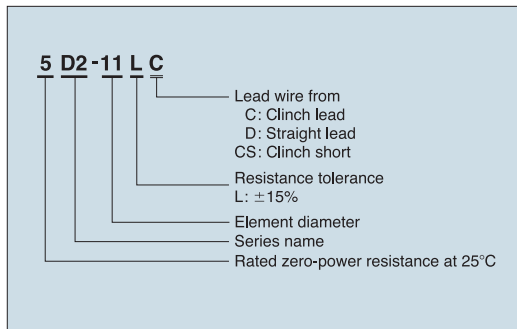

**Safety standards**  
 UL1434 File No. E926689  
 (1D2-22 excluded)

**Specifications : D2 Series Version 1**

Part No.	Rated zero-power resistance (±15%)	Dissipation factor	Thermal time constant	Maximum current at 25°C	Residual resistance	Maximum permissible capacitance		Category temperature range
	[Ω]					[mW/°C]	[S]	
5D2-07 □ □	5.0	(30)	(35)	3.0	0.36	400	80	-40~+160
8D2-07 □ □	8.0		(41)					
10D2-07 □ □	10.0		(45)	1.7	0.72	680	140	
12D2-07 □ □	12.0		(41)					
16D2-07 □ □	16.0		(45)	1.0	1.43	960	190	
22D2-07 □ □	22.0		(50)					
2D2-10 □ □	2.0	(32)	(50)	4.0	0.22	1720	350	
3D2-10 □ □	3.0		(53)					
5D2-10 □ □	5.0		(53)	1.8	0.71	830	170	
8D2-10 □ □	8.0		(70)					
10D2-10 □ □	10.0		(75)	5.0	0.20	3080	630	
12D2-10 □ □	12.0		(53)					
16D2-10 □ □	16.0	(70)	2.5	0.47	1390	280		
2D2-14 □ □	2.0	(36)					(90)	
3D2-14 □ □	3.0		(80)	2.0	0.71	2190	450	
4D2-14 □ □	4.0		(95)					
5D2-14 □ □	5.0		(110)	2.0	0.71	2190	450	
8D2-14 □ □	8.0		(80)					
10D2-14 □ □	10.0		(95)	1.8	0.94	2790	570	
12D2-14 □ □	12.0	(105)	1.8					0.94
16D2-14 □ □	16.0	(115)		1.8	0.94	2790	570	

The rated values in the "dissipation factor" and "thermal time constant" columns are reference values.

Specifications : D2 Series Version 2

Part No.	Rated zero-power resistance (±15%)	Dissipation factor	Thermal time constant	Maximum current at 25°C	Residual resistance	Maximum permissible capacitance		Category temperature range	Rated B-value (±5%)		
	[Ω]	[mW/°C]	[S]	[A]	[Ω]	AC 100V	AC 220V	(°C)	[K]		
5D2-05 □ □	5.0	(15)	(20)	2.0	0.48	860	170	-50~+150	2650		
10D2-05 □ □	10.0	(7)		1.0	0.91				2700		
20D2-05 □ □	20.0	(1)		0.3	1.66				2800		
5D2-08 □ □	5.0	(22)	(35)	3.0	0.35	1260	260	-50~+170	2700		
10D2-08 □ □	10.0	(17)		2.0	0.63				2800		
15D2-08 □ □	15.0	(26)			0.94	2800					
20D2-08 □ □	20.0	(8)		1.0	1.13	2880	590		2900		
2D2-11 □ □	2.0	(26)	(40)	5.0	0.15	2700	550	-50~+170	2650		
3D2-11 □ □	3.0	(24)		4.0	0.22	4830	990		2650		
4D2-11 □ □	4.0	(31)				0.28	2880		590	2700	
5D2-11 □ □	5.0	(39)				0.35	2700		550	2700	
8D2-11 □ □	8.0	(31)		3.0	0.50	2880	590		2800		
10D2-11 □ □	10.0	(42)		3.1	0.63				2800		
12D2-11 □ □	12.0	(21)		2.0	0.75	4030	830		2800		
15D2-11 □ □	15.0	(34)		2.5	0.80	2880	590		2950		
16D2-11 □ □	16.0	(37)							0.86	2950	
20D2-11 □ □	20.0	(28)							1.02	3000	
1D2-13 □ □	1.0	(12)		(55)	6.0	0.06	860		170	-50~+200	2650
2D2-13 □ □	2.0	(21)	5.0		0.10	2700		550			2700
4D2-13 □ □	4.0	(24)				0.18		2800			
4.7D2-13 □ □	4.7	(26)				0.19	2900				
5D2-13 □ □	5.0	(27)	4.0		0.27	2880	590	3000			
8D2-13 □ □	8.0	(25)						0.32	3050		
10D2-13 □ □	10.0	(29)						0.41	3000		
12D2-13 □ □	12.0	(37)	3.0		0.48	4830	990	3050			
15D2-13 □ □	15.0	(25)						0.51	3050		
16D2-13 □ □	16.0	(26)						0.51	3050		
1D2-15 □ □	1.0	(22)	(70)		8.0	0.06	6910	1420	-50~+200		2650
1.5D2-15 □ □	1.5	(29)		7.0	0.08	4030				830	2650
2D2-15 □ □	2.0	(37)									0.10
3D2-15 □ □	3.0	(36)					0.13	2800			
4D2-15 □ □	4.0	(48)		6.0	0.18	4030	830	2800			
4.7D2-15 □ □	4.7	(37)						0.18		2900	
5D2-15 □ □	5.0	(39)						0.19		2900	
8D2-15 □ □	8.0	(39)		5.0	0.27	5760	1190	3000			
10D2-15 □ □	10.0	(49)						0.34		3000	
12D2-15 □ □	12.0	(54)						0.39		3050	
15D2-15 □ □	15.0	(41)		4.0	0.45	5760	1190	3100			
16D2-15 □ □	16.0	(44)						0.48		3100	
4D2-18 □ □	4.0	(59)						(90)		8.0	0.16
5D2-18 □ □	5.0	(66)		8.0	0.18	2950					
8D2-18 □ □	8.0	(53)	6.0			0.26	3050				
10D2-18 □ □	10.0	(62)					0.30		3100		
47D2-18 □ □	47.0	(21)		2.0	0.94		3450				
3D2-22 □ □	3.0	(48)	(130)	8.0	0.13	12600	2610		2800		
4D2-22 □ □	4.0	(59)		8.0	0.16			2900			
6D2-22 □ □	6.0	(43)						6.0	0.21	3000	

**Dimensions**

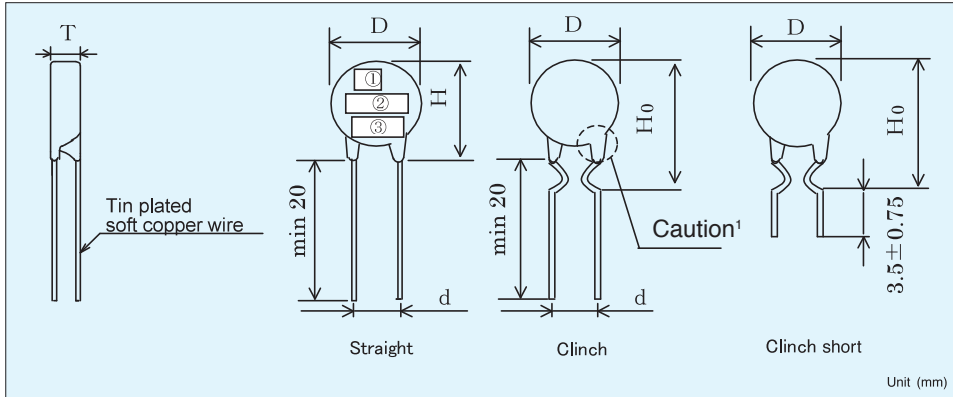

①: Trade mark **5**                      ②: Part No.<sup>2</sup>                      ③: Lot No.

- 1 : Exerting physical stress on on the lead wire from the side may cause cracks and damage the "legs".
- 2 : For example D2-05: Marking is 5D2 whereas "5" stands for resistance (ohm) and D2 for the type.

**Dimensions Version 1**

Part No.	Dimensions [mm]					
	D	H	T	d	H0	Lead wire
<input type="checkbox"/> D2-07 <input type="checkbox"/> <input type="checkbox"/>	max. 11.0	max. 13.0	max. 9.0	5.0±1.0	max. 16.0	(φ0.8)
<input type="checkbox"/> D2-10 <input type="checkbox"/> <input type="checkbox"/>	max. 13.0	max. 17.0			max. 19.5	
<input type="checkbox"/> D2-14 <input type="checkbox"/> <input type="checkbox"/>	max. 17.0	max. 21.0		7.5±1.0	max. 22.5	

**Dimensions Version 2**

Part No.	Dimensions [mm]					
	D	H	T	d	H0	Lead wire
<input type="checkbox"/> D2-05 <input type="checkbox"/> <input type="checkbox"/>	max 8.5	max 11.5	max. 7.0	5.0±1.0	max 15.5	(φ0.8)
<input type="checkbox"/> D2-08 <input type="checkbox"/> <input type="checkbox"/>	max 10.0	max 13.0			max 17.0	
<input type="checkbox"/> D2-11 <input type="checkbox"/> <input type="checkbox"/>	max 11.5	max 15.0	max. 8.0	7.5±1.0	max 18.5	
<input type="checkbox"/> D2-13 <input type="checkbox"/> <input type="checkbox"/>	max 14.5	max 18.0			max 21.5	
<input type="checkbox"/> D2-15 <input type="checkbox"/> <input type="checkbox"/>	max 16.5	max 20.0		10.0±1.0	max 23.0	(φ1.0)
<input type="checkbox"/> D2-18 <input type="checkbox"/> <input type="checkbox"/>	max 19.5	max 23.0			max 26.0	
<input type="checkbox"/> D2-22 <input type="checkbox"/> <input type="checkbox"/>	max 23.0	max 26.5	max. 8.5	max 29.5		