



NEXCOM International Co., Ltd.

IoT Automation Solutions

Embedded Computing (3.5" CPU Board)

EBC 355

User Manual

Contents

Preface

Copyright	iv
Disclaimer	iv
Acknowledgements	iv
Regulatory Compliance Statements	iv
Declaration of Conformity	iv
RoHS Compliance	v
Warranty and RMA	vi
Safety Information	viii
Installation Recommendations	viii
Safety Precautions	ix
Technical Support and Assistance	x
Conventions Used in this Manual	x
Global Service Contact Information	xi
Package Contents	xiii
Ordering Information	xiv

Chapter 1: Product Introduction

Overview	1
Key Features	1
Hardware Specifications	2
Knowing Your EBC 355	4
Top View	4
Bottom View	5

Chapter 2: Jumpers and Connectors

Before You Begin	6
Precautions	6
Jumper Settings	7
Locations of the Jumpers and Connectors	8
Top View	8
Bottom View	9
Jumpers	10
AT/ATX Power Type Select	10
LCD Power Select	10
PWM/CCFL Select	11
Connector Pin Definitions	12
External I/O Interfaces	12
VGA	12
HDMI	12
USB 3.0 Connector B	13
USB 3.0 Connector A	13
LAN1 Port	14
LAN2 Port	14
Internal Connectors	15
ATX Power Output Connector	15
Power Button (ATX)	15
RTC Clear Select	16
System Reset	16



SMBus	17
PS/2 Keyboard/Mouse Connector	17
System Fan Connector	18
GPIO Connector.....	18
COM Port 1 (RS232).....	19
COM Port 2 (RS232/RS422/RS485)	19
COM Port 3 (RS232).....	20
COM Port 4 (RS232).....	20
Mic-in Connector	21
Line-out Connector	21
Speaker-out Connector	22
LVDS Connector A	22
LVDS Connector B	23
LVDS Panel Inverter Connector	23
Mini-PCIe Slot (Wi-Fi)	24
Mini-PCIe Slot (3G).....	25
SIM Card Connector	26
SATA Connector A	26
SATA DOM Connector	27
SATA Power Connector	27
SATA DOM Power Connector.....	28
Power/HDD LED Connector.....	28
Block Diagram	29

Chapter 3: BIOS Setup

About BIOS Setup	30
When to Configure the BIOS.....	30
Default Configuration	31
Entering Setup	31
Legends	31
BIOS Setup Utility.....	33

Main	33
Advanced	33
Chipset.....	41
Security	44
Boot.....	45
Save & Exit	46

Appendix A: Watchdog Timer Setting.....47

Appendix B: GPI/O Programming Guide.....48

Preface

Copyright

This publication, including all photographs, illustrations and software, is protected under international copyright laws, with all rights reserved. No part of this manual may be reproduced, copied, translated or transmitted in any form or by any means without the prior written consent from NEXCOM International Co., Ltd.

Disclaimer

The information in this document is subject to change without prior notice and does not represent commitment from NEXCOM International Co., Ltd. However, users may update their knowledge of any product in use by constantly checking its manual posted on our website: <http://www.nexcom.com>. NEXCOM shall not be liable for direct, indirect, special, incidental, or consequential damages arising out of the use of any product, nor for any infringements upon the rights of third parties, which may result from such use. Any implied warranties of merchantability or fitness for any particular purpose is also disclaimed.

Acknowledgements

EBC 355 is a trademark of NEXCOM International Co., Ltd. All other product names mentioned herein are registered trademarks of their respective owners.

Regulatory Compliance Statements

This section provides the FCC compliance statement for Class B devices and describes how to keep the system CE compliant.

Declaration of Conformity

FCC

This equipment has been tested and verified to comply with the limits for a Class B digital device, pursuant to Part 15 of FCC Rules. These limits are designed to provide reasonable protection against harmful interference when the equipment is operated in a commercial environment. This equipment generates, uses, and can radiate radio frequency energy and, if not installed and used in accordance with the instructions, may cause harmful interference to radio communications. Operation of this equipment in a residential area (domestic environment) is likely to cause harmful interference, in which case the user will be required to correct the interference (take adequate measures) at their own expense.

CE

The product(s) described in this manual complies with all applicable European Union (CE) directives if it has a CE marking. For computer systems to remain CE compliant, only CE-compliant parts may be used. Maintaining CE compliance also requires proper cable and cabling techniques.

RoHS Compliance



NEXCOM RoHS Environmental Policy and Status Update

NEXCOM is a global citizen for building the digital infrastructure. We are committed to providing green products and services, which are compliant with European Union RoHS (Restriction on Use of Hazardous Substance in Electronic Equipment) directive 2011/65/EU, to be your trusted green partner and to protect our environment.

RoHS restricts the use of Lead (Pb) < 0.1% or 1,000ppm, Mercury (Hg) < 0.1% or 1,000ppm, Cadmium (Cd) < 0.01% or 100ppm, Hexavalent Chromium (Cr6+) < 0.1% or 1,000ppm, Polybrominated biphenyls (PBB) < 0.1% or 1,000ppm, and Polybrominated diphenyl Ethers (PBDE) < 0.1% or 1,000ppm.

In order to meet the RoHS compliant directives, NEXCOM has established an engineering and manufacturing task force in to implement the introduction of green products. The task force will ensure that we follow the standard NEXCOM development procedure and that all the new RoHS components and new manufacturing processes maintain the highest industry quality levels for which NEXCOM are renowned.

The model selection criteria will be based on market demand. Vendors and suppliers will ensure that all designed components will be RoHS compliant.

How to recognize NEXCOM RoHS Products?

For existing products where there are non-RoHS and RoHS versions, the suffix "(LF)" will be added to the compliant product name.

All new product models launched after January 2013 will be RoHS compliant. They will use the usual NEXCOM naming convention.

Warranty and RMA

NEXCOM Warranty Period

NEXCOM manufactures products that are new or equivalent to new in accordance with industry standard. NEXCOM warrants that products will be free from defect in material and workmanship for 2 years, beginning on the date of invoice by NEXCOM. HCP series products (Blade Server) which are manufactured by NEXCOM are covered by a three year warranty period.

NEXCOM Return Merchandise Authorization (RMA)

- Customers shall enclose the “NEXCOM RMA Service Form” with the returned packages.
- Customers must collect all the information about the problems encountered and note anything abnormal or, print out any on-screen messages, and describe the problems on the “NEXCOM RMA Service Form” for the RMA number apply process.
- Customers can send back the faulty products with or without accessories (manuals, cable, etc.) and any components from the card, such as CPU and RAM. If the components were suspected as part of the problems, please note clearly which components are included. Otherwise, NEXCOM is not responsible for the devices/parts.
- Customers are responsible for the safe packaging of defective products, making sure it is durable enough to be resistant against further damage and deterioration during transportation. In case of damages occurred during transportation, the repair is treated as “Out of Warranty.”
- Any products returned by NEXCOM to other locations besides the customers’ site will bear an extra charge and will be billed to the customer.

Repair Service Charges for Out-of-Warranty Products

NEXCOM will charge for out-of-warranty products in two categories, one is basic diagnostic fee and another is component (product) fee.

Repair Service Charges for Out-of-Warranty Products

NEXCOM will charge for out-of-warranty products in two categories, one is basic diagnostic fee and another is component (product) fee.

System Level

- Component fee: NEXCOM will only charge for main components such as SMD chip, BGA chip, etc. Passive components will be repaired for free, ex: resistor, capacitor.
- Items will be replaced with NEXCOM products if the original one cannot be repaired. Ex: motherboard, power supply, etc.
- Replace with 3rd party products if needed.
- If RMA goods can not be repaired, NEXCOM will return it to the customer without any charge.

Board Level

- Component fee: NEXCOM will only charge for main components, such as SMD chip, BGA chip, etc. Passive components will be repaired for free, ex: resistors, capacitors.
- If RMA goods can not be repaired, NEXCOM will return it to the customer without any charge.

Warnings

Read and adhere to all warnings, cautions, and notices in this guide and the documentation supplied with the chassis, power supply, and accessory modules. If the instructions for the chassis and power supply are inconsistent with these instructions or the instructions for accessory modules, contact the supplier to find out how you can ensure that your computer meets safety and regulatory requirements.

Cautions

Electrostatic discharge (ESD) can damage system components. Do the described procedures only at an ESD workstation. If no such station is available, you can provide some ESD protection by wearing an antistatic wrist strap and attaching it to a metal part of the computer chassis.

Safety Information

Before installing and using the device, note the following precautions:

- Read all instructions carefully.
- Do not place the unit on an unstable surface, cart, or stand.
- Follow all warnings and cautions in this manual.
- When replacing parts, ensure that your service technician uses parts specified by the manufacturer.
- Avoid using the system near water, in direct sunlight, or near a heating device.
- The load of the system unit does not solely rely for support from the rackmounts located on the sides. Firm support from the bottom is highly necessary in order to provide balance stability.
- The computer is provided with a battery-powered real-time clock circuit. There is a danger of explosion if battery is incorrectly replaced. Replace only with the same or equivalent type recommended by the manufacturer. Discard used batteries according to the manufacturer's instructions.

Installation Recommendations

Ensure you have a stable, clean working environment. Dust and dirt can get into components and cause a malfunction. Use containers to keep small components separated.

Adequate lighting and proper tools can prevent you from accidentally damaging the internal components. Most of the procedures that follow require only a few simple tools, including the following:

- A Philips screwdriver
- A flat-tipped screwdriver
- A grounding strap
- An anti-static pad

Using your fingers can disconnect most of the connections. It is recommended that you do not use needle-nose pliers to disconnect connections as these can damage the soft metal or plastic parts of the connectors.

Safety Precautions

1. Read these safety instructions carefully.
2. Keep this User Manual for later reference.
3. Disconnect the equipment from any AC outlet before cleaning or installing a component inside the chassis. Use a damp cloth. Do not use liquid or spray detergents for cleaning.
4. To prevent electrostatic build-up, leave the board in its anti-static bag until you are ready to install it.
5. For plug-in equipment, the power outlet socket must be located near the equipment and must be easily accessible.
6. Keep the board away from humidity.
7. Put the board on a stable surface. Dropping it or letting it fall may cause damage.
8. Wear anti-static wrist strap.
9. Do all preparation work on a static-free surface.
10. Make sure the voltage of the power source is correct before connecting the equipment to the power outlet.
11. Hold the board only by its edges. Be careful not to touch any of the components, contacts or connections.
12. All cautions and warnings on the board should be noted.
13. Use the correct mounting screws and do not over tighten the screws.
14. Keep the original packaging and the anti-static bag; in case the board has to be returned for repair or replacement.

Technical Support and Assistance

1. For the most updated information of NEXCOM products, visit NEXCOM's website at www.nexcom.com.
2. For technical issues that require contacting our technical support team or sales representative, please have the following information ready before calling:
 - Product name and serial number
 - Detailed information of the peripheral devices
 - Detailed information of the installed software (operating system, version, application software, etc.)
 - A complete description of the problem
 - The exact wordings of the error messages

Warning!

1. Handling the unit: carry the unit with both hands and handle it with care.
2. Maintenance: to keep the unit clean, use only approved cleaning products or clean with a dry cloth.
3. CompactFlash: Turn off the unit's power before inserting or removing a CompactFlash storage card.

Conventions Used in this Manual



Warning:

Information about certain situations, which if not observed, can cause personal injury. This will prevent injury to yourself when performing a task.



Caution:

Information to avoid damaging components or losing data.



Note:

Provides additional information to complete a task easily.

Global Service Contact Information

Headquarters

NEXCOM International Co., Ltd.

15F, No. 920, Chung-Cheng Rd.,
ZhongHe District, New Taipei City, 23586,
Taiwan, R.O.C.

Tel: +886-2-8226-7786

Fax: +886-2-8226-7782

www.nexcom.com

America

USA

NEXCOM USA

2883 Bayview Drive,
Fremont CA 94538, USA

Tel: +1-510-656-2248

Fax: +1-510-656-2158

Email: sales@nexcom.com

www.nexcom.com

Asia

Taiwan

NEXCOM Intelligent Systems

Taipei Office

13F, No.920, Chung-Cheng Rd.,
ZhongHe District,
New Taipei City, 23586, Taiwan, R.O.C.

Tel: +886-2-8226-7796

Fax: +886-2-8226-7792

Email: sales@nexcom.com.tw

www.nexcom.com.tw

NEXCOM Intelligent Systems

Taichung Office

16F, No.250, Sec. 2, Chongde Rd.,
Beitun Dist.,

Taichung City 406, R.O.C.

Tel: +886-4-2249-1179

Fax: +886-4-2249-1172

Email: sales@nexcom.com.tw

www.nexcom.com.tw

Japan

NEXCOM Japan

9F, Tamachi Hara Bldg.,
4-11-5, Shiba Minato-ku,
Tokyo, 108-0014, Japan

Tel: +81-3-5419-7830

Fax: +81-3-5419-7832

Email: sales@nexcom-jp.com

www.nexcom-jp.com

China

NEXCOM China

1F & 2F, Block A, No. 16 Yonyou Software Park,
No. 68 Beiqing Road, Haidian District,
Beijing, 100094, China

Tel: +86-010-5704-2680

Fax: +86-010-5704-2681

Email: sales@nexcom.cn

www.nexcom.cn

Chengdu Office

9F, Shuxiangxie, Xuefu Garden,
No.12 Section 1, South Yihuan Rd.,
Chengdu, 610061, China
Tel: +86-28-8523-0186
Fax: +86-28-8523-0186
Email: sales@nexcom.cn
www.nexcom.cn

Shanghai Office

Room 603/604, Huiyinmingzun Plaza Bldg., 1,
No.609, Yunlin East Rd.,
Shanghai, 200333, China
Tel: +86-21-5278-5868
Fax: +86-21-3251-6358
Email: sales@nexcom.cn
www.nexcom.cn

Shenzhen Office

Room1707, North Block, Pines Bldg.,
No.7 Tairan Rd., Futian Area,
Shenzhen, 518040, China
Tel: +86-755-8332-7203
Fax: +86-755-8332-7213
Email: sales@nexcom.cn
www.nexcom.cn

Wuhan Office

1-C1804/1805, Mingze Liwan, No. 519
South Luoshi Rd., Hongshan District,
Wuhan, 430070, China
Tel: +86-27-8722-7400
Fax: +86-27-8722-7400
Email: sales@nexcom.cn
www.nexcom.cn

Europe

United Kingdom

NEXCOM EUROPE

10 Vincent Avenue,
Crownhill Business Centre,
Milton Keynes, Buckinghamshire
MK8 0AB, United Kingdom
Tel: +44-1908-267121
Fax: +44-1908-262042
Email: sales.uk@nexcom.eu
www.nexcom.eu

Italy

NEXCOM ITALIA S.r.l

Via Lanino 42,
21047 Saronno (VA), Italia
Tel: +39 02 9628 0333
Fax: +39 02 9625570
Email: nexcomitalia@nexcom.eu
www.nexcomitalia.it

Package Contents

Before continuing, verify that the EBC 355 package that you received is complete. Your package should have all the items listed in the following table.

EBC 355-E3845 (PN: 10E00035502X0) / EBC 355-E3826 (PN: 10E00035500X0)

Item	Part Number	Name	Description	Qty
1	20E00035502X0	ASSY EBC 355-E3845		1
2	60177A0359X00	(N)EBC 355 Quick Reference Guide VER:A SIZE:A4	KRAMER	1
3	602DCD0845X00	(N)EBC 355 CD DRIVER VER:1.0	JCL	1

EBC 355 Cable Kit Optional (PN: 10E00035501X0)

Item	Part Number	Name	Description	Qty
1	60233ATA73X00	SATA Cable ACMELUX:19922413	Standard L:300mm	1
2	60233PS223X00	EBC563IO PS2 KB/MS Cable ACMELUX:19922439	PS2 to JST 8PIN 2.54mm L:200mm+-10mm	1
3	60233PW148X00	SATA Power Cable BEST:901-0405-300R	Housing 4P to Housing 5P L:300mm	1
4	60233SIO62X00	COM Port Cable CP:NEX-110819-01	UL2651#28x9C-DB9+TU1001-10 L:200mm	2

EBC 355 Heatsink Kit Optional (PN: 10E00035504X0)

Item	Part Number	Name	Description	Qty
1	5044440079X00	Gasket for VIA CPU KGS:C-4505(20X20x1)+G4000	20x20x1.1mm	1
2	5044440090X00	(H)Thermal Pad APUS:3A2015001001500	15x10x1.5mm XR-PE	1
3	5050300683X00	(N)EBC 355 Heatsink VER:A THERMO TOUCH	74.3x98x21.4mm AL:6063	1

Ordering Information

The following below provides ordering information for EBC 355.

EBC 355-E3826 (P/N: 10E00035500X0) RoHS Compliant

Low power embedded board with Intel® Atom™ processor E3826 and based on Intel® integrated graphics engine w/ HDMI/24/48bit LVDS/4x USB3.0/4x COMs/2x Mini-PCIe/2x Gigabit LAN/2x SATA

EBC 355-E3845 (P/N: 10E000355001X0) RoHS Compliant

Low power embedded board with Intel® Atom™ processor E3845 and based on Intel® integrated graphics engine w/ HDMI/24/48bit LVDS/4x USB3.0/4x COMs/2x Mini-PCIe/2x Gigabit LAN/2x SATA

Chapter 1: Product Introduction

Overview

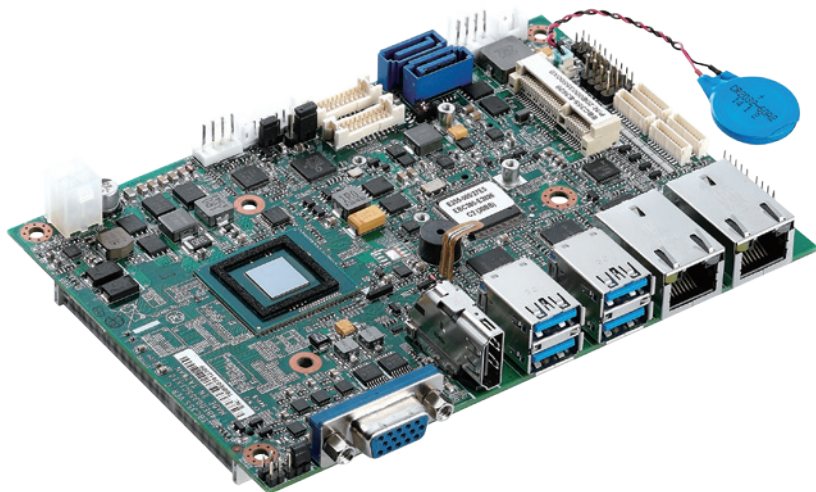

Key Features

- On-board Intel® Atom™ Processor E3800 Product Family
- One 204-pin SO-DIMM socket supports up to 8GB DDR3L 1066/1333 MHz SDRAM
- Display: HDMI/VGA/1x LVDS (2x DF13 20-pin 24/48-bit Single channel)
- 2x Mini-PCIe
- 2x Intel® i210 PCI Express Gigabit Ethernet
- 2x SATA2.0
- 4x USB3.0, 4-in/4-out GPIO, Mic-in , Speak out
- Serial port: 3x RS232, 1x RS232/422/485 port
- Support AT/ATX mode and single +12VDC input

Hardware Specifications

CPU Support

- Support Intel® Atom™ processor E3800 product family

Main Memory

- Single 204-pin SO-DIMM socket supports up to 8 GB DDR3L 1066/1333 MHz SDRAM

Platform Control Hub

- Atom™ processor E3800 product family (formerly codenamed “Bay Trail-I”)

BIOS

- AMI System BIOS
- Plug and play support
- Advanced Power Management and Advanced Configuration & Power Interface support

On-board LAN

- 2x Intel® PCI Express Gigabit Ethernet
- Support Boot From LAN (PXE)
- 2x RJ45 with LED

Display

- Integrated Intel® Gen.7 Graphics Engine
- Analog VGA interface
- Analog VGA interface: 1x DB-15 connector, resolution up to 1920 x 1200 @75Hz
- HDMI interface: 1x HDMI connector, resolution up to 1920 x 1200

- LVDS interface: 1x dual (24/48-bit) LVDS panel, resolution up to 1920 x 1200 DF13 20-pin LVDS connector for internal connection

Audio

- Realtek ALC886 CODEC for High Definition:
 - 1x 4 2.0 pitch pin-header for Mic-in
 - 1x 4 2.0 pitch pin-header for Line-out
 - 1x 5 2.0 pitch pin-header for speaker out

On-board LAN

- 2x Intel® i210 Gigabit Ethernet
- Support PXE boot from LAN, wake on LAN function

Expansion

- 2x Mini-PCIe

I/O Interface

- Serial port: 4 ports
 - COM1, 3, 4 support RS232 with 10-pin box header
 - COM2 support RS232/422/485 with 10-pin box header
- USB 3.0: 4 ports
 - 4x ports edge connector
- 8 GPIO lines via header (GPI 0~3 and GPO0~3) TTL level (0/5V)
- On-board power LED and HDD active LED pin header
- 1x 4-pin fan connector (for CPU)
- 1x keyboard/mouse pin header
- Onboard buzzer/SMBus2.0/reset SW/on & off switch button

Edge I/O Interface

- 1x VGA connector
- 1x HDMI connector
- 2x dual stack USB 3.0 connector
- 2x RJ45 with LED connector

Watchdog Timer

- Watchdog time-out can be programmed by software from 1 second to 255 seconds, and from 1 minute to 255 minutes (tolerance 15% under room temperature 25°C)

Storage

- 2x SATA2.0 ports

System Monitor

- Monitoring of 4 voltages and 2 temperatures
- 4 voltage (Vcore, +12V, +3.3V, 5V)
- 2 temperatures (CPU, system)
- 1 fan speed detection

On-board RTC

- On-chip RTC with battery backup
- 1x external Li-ion battery

Power Requirements

- Power requirement: +12V DC Input
- One 4-pin power connector

Dimensions

- 146mm (L) x 102mm (W) 5.7" x 4.0"

Environment

- Board level operating temperatures: -20°C to 60°C
- Storage temperatures: -25°C to 85°C
- Relative humidity:
 - 10% to 90% (operating, non-condensing)
 - 5% to 95% (non-operating, non-condensing)

Certifications

- Meet CE
- FCC Class A

Knowing Your EBC 355

Top View

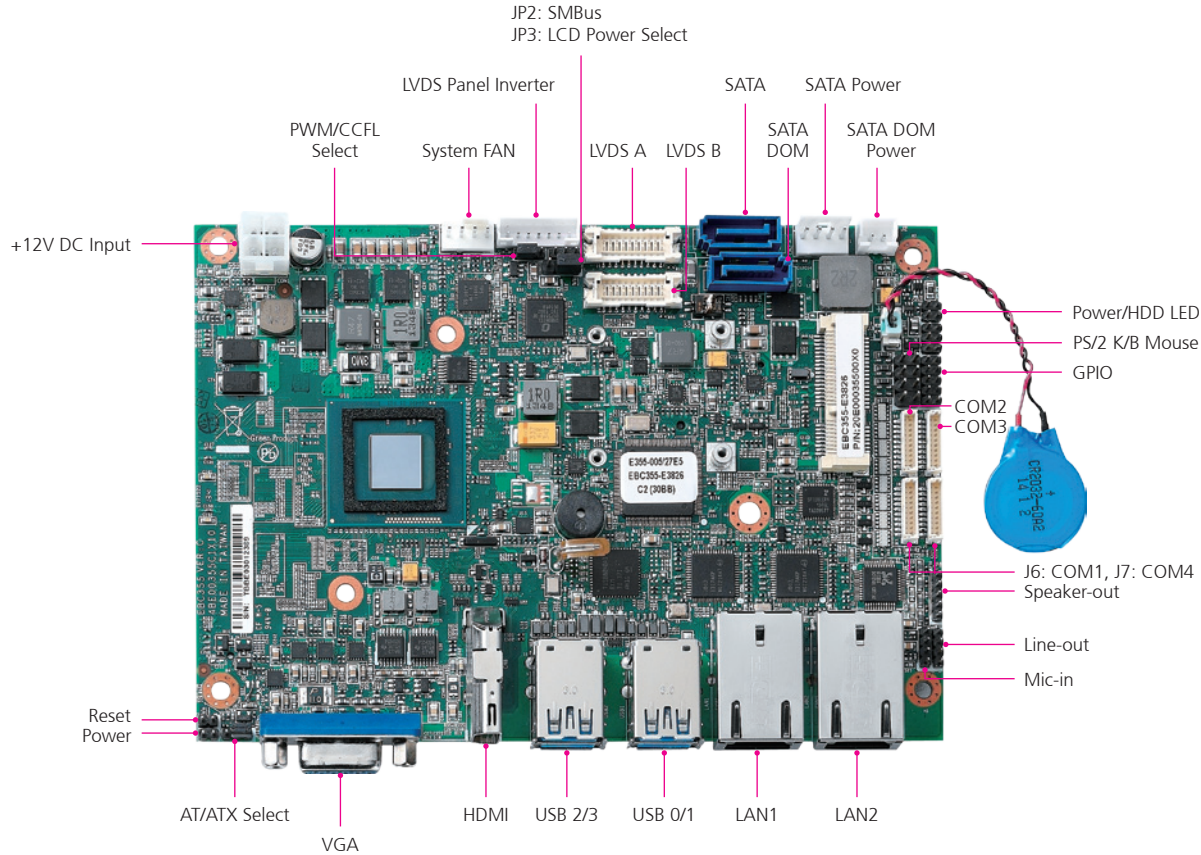

Bottom View

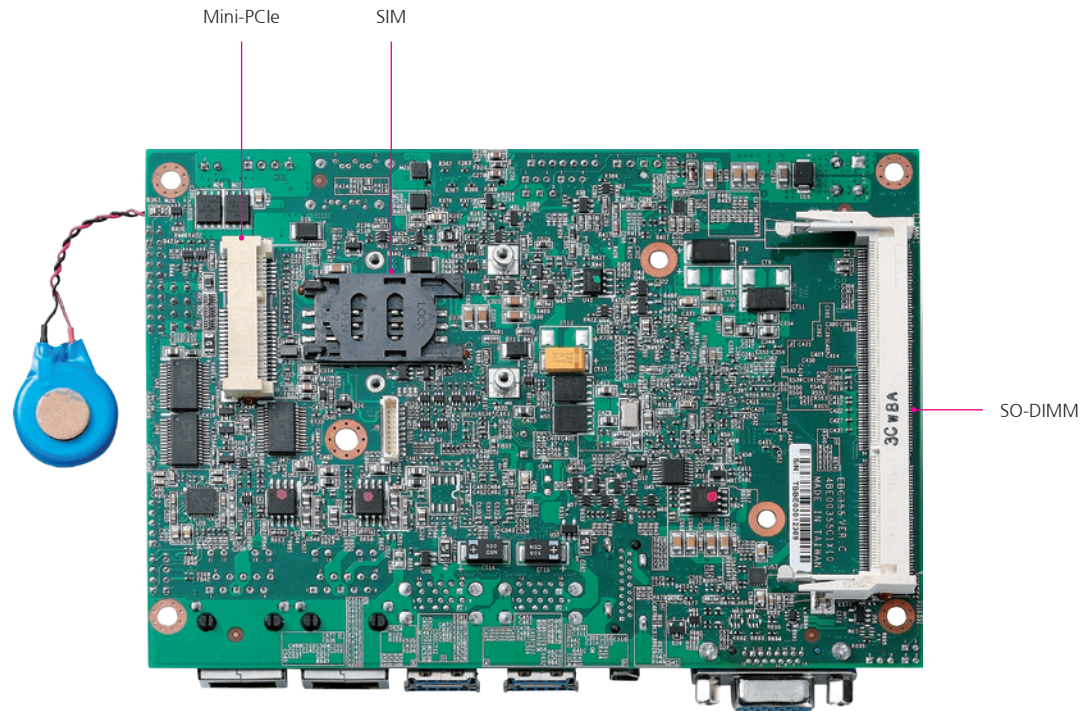

Chapter 2: Jumpers and Connectors

This chapter describes how to set the jumpers and connectors on the EBC 355 motherboard.

Before You Begin

- Ensure you have a stable, clean working environment. Dust and dirt can get into components and cause a malfunction. Use containers to keep small components separated.
- Adequate lighting and proper tools can prevent you from accidentally damaging the internal components. Most of the procedures that follow require only a few simple tools, including the following:
 - A Philips screwdriver
 - A flat-tipped screwdriver
 - A set of jewelers screwdrivers
 - A grounding strap
 - An anti-static pad
- Using your fingers can disconnect most of the connections. It is recommended that you do not use needle-nosed pliers to disconnect connections as these can damage the soft metal or plastic parts of the connectors.
- Before working on internal components, make sure that the power is off. Ground yourself before touching any internal components, by touching a metal object. Static electricity can damage many of the electronic components. Humid environments tend to have less static electricity than

dry environments. A grounding strap is warranted whenever danger of static electricity exists.

Precautions

Computer components and electronic circuit boards can be damaged by discharges of static electricity. Working on computers that are still connected to a power supply can be extremely dangerous.

Follow the guidelines below to avoid damage to your computer or yourself:

- Always disconnect the unit from the power outlet whenever you are working inside the case.
- If possible, wear a grounded wrist strap when you are working inside the computer case. Alternatively, discharge any static electricity by touching the bare metal chassis of the unit case, or the bare metal body of any other grounded appliance.
- Hold electronic circuit boards by the edges only. Do not touch the components on the board unless it is necessary to do so. Don't flex or stress the circuit board.
- Leave all components inside the static-proof packaging that they shipped with until they are ready for installation.
- Use correct screws and do not over tighten screws.

Jumper Settings

A jumper is the simplest kind of electric switch. It consists of two metal pins and a cap. When setting the jumpers, ensure that the jumper caps are placed on the correct pins. When the jumper cap is placed on both pins, the jumper is short. If you remove the jumper cap, or place the jumper cap on just one pin, the jumper is open.

Refer to the illustrations below for examples of what the 2-pin and 3-pin jumpers look like when they are short (on) and open (off).

Two-Pin Jumpers: Open (Left) and Short (Right)

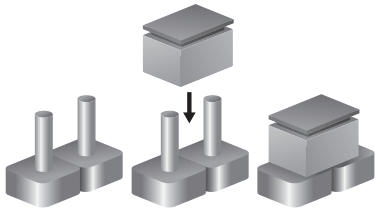

Three-Pin Jumpers: Pins 1 and 2 are Short

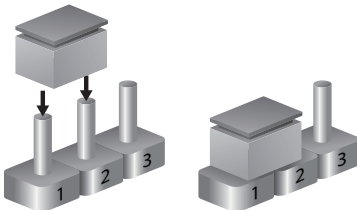

Locations of the Jumpers and Connectors

The figure below shows the location of the jumpers and connectors.

Top View

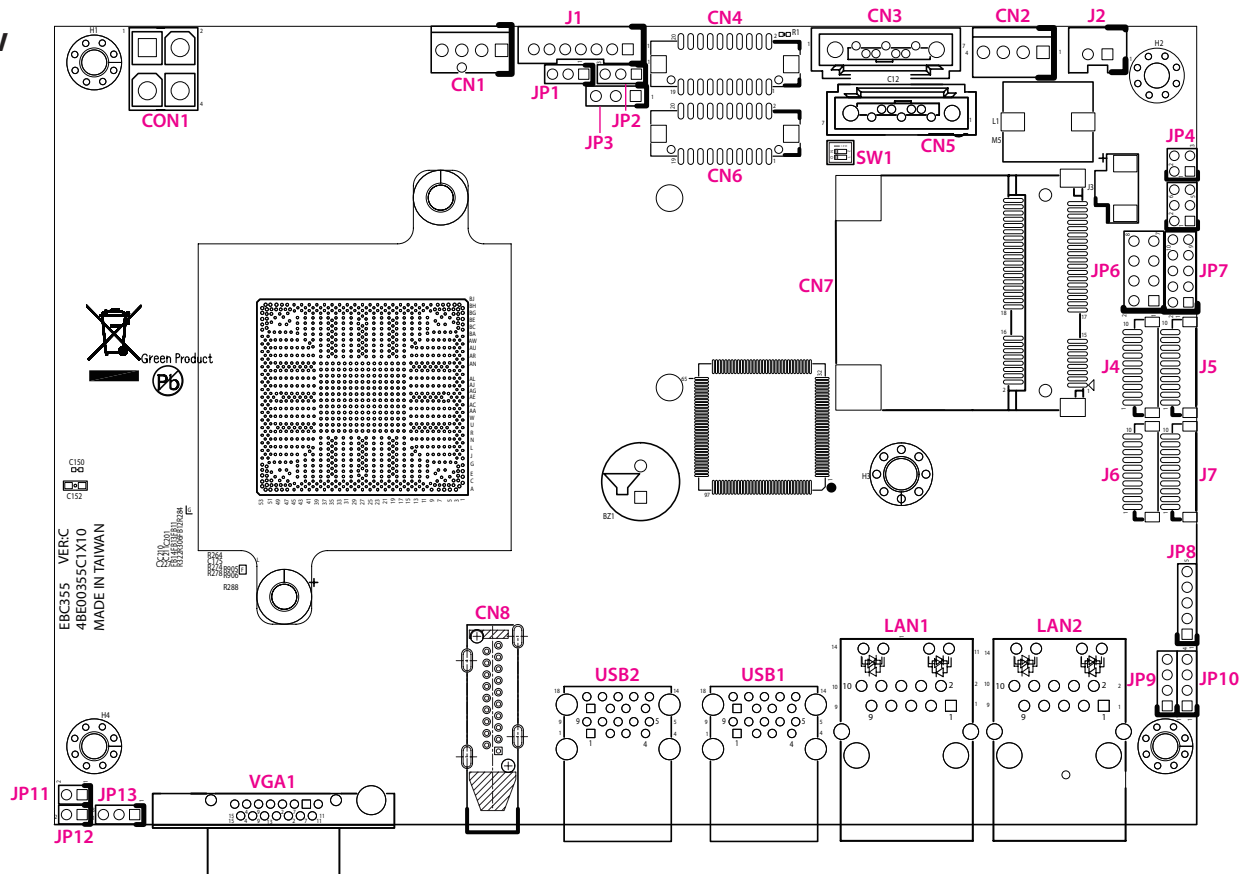

Bottom View

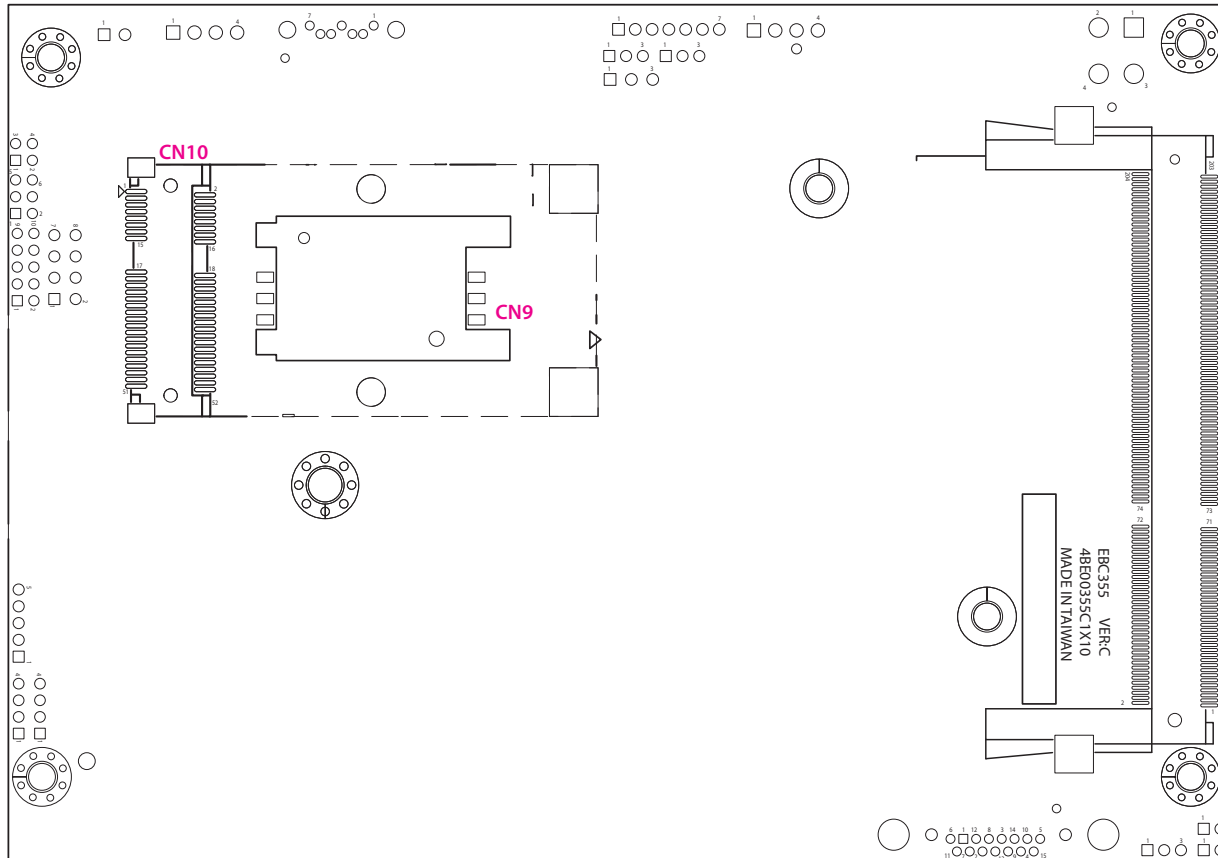

Jumpers

AT/ATX Power Type Select

Connector type: 1x3 3-pin header, 2.0mm pitch
Connector location: JP13



Pin	Settings
1-2 On	AT Mode
2-3 On	ATX Mode

LCD Power Select

Connector type: 1x3 3-pin header, 2.54mm
Connector location: JP3



Pin	Settings
1-2 On	VCC3
2-3 On	VCC5

PWM/CCFL Select

Connector type: 1x3 3-pin header, 2.0mm pitch
Connector location: JP1



Pin	Definition
1-2	CCFL
2-3	PWM

Connector Pin Definitions

External I/O Interfaces

VGA

Connector type: DB-15 port, 15-pin D-Sub

Connector location: VGA1

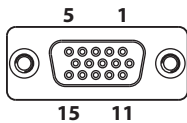

Pin	Definition	Pin	Definition
1	RED_VGA	2	GREEN_VGA
3	BLUE_VGA	4	NC
5	GND	6	VGADET
7	GND	8	GND
9	VCC5	10	GND
11	NC	12	DATA_VGA
13	HSYNC_VGA	14	VSYNC_VGA
15	DDCCLK_VGA		

HDMI

Connector type: HDMI port

Connector location: CN8

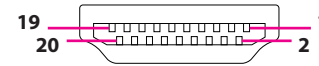

Pin	Definition	Pin	Definition
1	DATA2P	2	GND
3	DATA2N	4	DATA1P
5	GND	6	DATA1N
7	DATA0P	8	GND
9	DATA0N	10	CLKP
11	GND	12	CLKN
13	NC	14	NC
15	SCL CLK	16	SCL Data
17	GND	18	VCC5
19	HPD	MH1	GND
MH2	GND	MH3	GND
MH4	GND		

USB 3.0 Connector B

Connector type: Dual USB port, Type A

Connector location: USB2

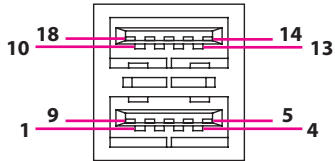

Pin	Definition	Pin	Definition
1	VCC5	2	DATA0-
3	DATA0+	4	GND
5	USB_RX2-	6	USB_RX2+
7	GND	8	USB_TX2-
9	USB_TX2+	10	VCC5
11	DATA1-	12	DATA1+
13	GND	14	USB_RX3-
15	USB_RX3+	16	GND
17	USB_TX3-	18	USB_TX3+

USB 3.0 Connector A

Connector type: Dual USB port, Type A

Connector location: USB1

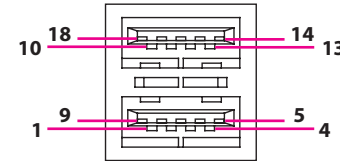

Pin	Definition	Pin	Definition
1	VCC5	2	DATA0-
3	DATA0+	4	GND
5	USB_RX0-	6	USB_RX0+
7	GND	8	USB_TX0-
9	USB_TX0+	10	VCC5
11	DATA1-	12	DATA1+
13	GND	14	USB_RX1-
15	USB_RX1+	16	GND
17	USB_TX1-	18	USB_TX1+

LAN1 Port

Connector type: RJ45 port with LEDs
 Connector location: LAN1

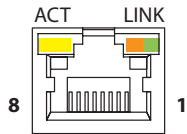

Act	Status
Flashing Yellow	Data activity
Off	No activity

Link	Status
Steady Green	1G network link
Steady Orange	100Mbps network link
Off	No link

Pin	Definition	Pin	Definition
1	LAN1_MDI0P	2	LAN1_MDI0N
3	LAN1_MDI1P	4	LAN1_MDI1N
5	1.5V	6	GND
7	LAN1_MDI2P	8	LAN1_MDI2N
9	LAN1_MDI3P	10	LAN1_MDI3N
11	LAN1_LED_LINK#	12	LAN1_LED_LINK1G#
13	LAN1_LED_ACT#	14	3VSB

LAN2 Port

Connector type: RJ45 port with LEDs
 Connector location: LAN2

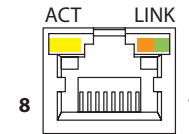

Act	Status
Flashing Yellow	Data activity
Off	No activity

Link	Status
Steady Green	1G network link
Steady Orange	100Mbps network link
Off	No link

Pin	Definition	Pin	Definition
1	LAN2_MDI0P	2	LAN2_MDI0N
3	LAN2_MDI1P	4	LAN2_MDI1N
5	1.5V	6	GND
7	LAN2_MDI2P	8	LAN2_MDI2N
9	LAN2_MDI3P	10	LAN2_MDI3N
11	LAN2_LED_LINK#	12	LAN2_LED_LINK1G#
13	LAN2_LED_ACT#	14	3VSB

Internal Connectors

ATX Power Output Connector

Connector type: 2x2 Aux power connector

Connector location: CON1

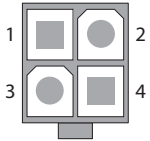

Pin	Definition
1	GND
2	GND
3	12V
4	12V

Power Button (ATX)

Connector type: 1x2 2-pin header, 2.0mm pitch

Connector location: JP12



Pin	Definition
1	ATXBT
2	GND

RTC Clear Select

Connector type: 2x2 4-pin DIP switch
Connector location: SW1

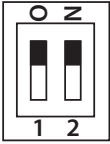

Pin	Definition
1 ON	Clear CMOS
2 ON	Clear ME

System Reset

Connector type: 1x2 2-pin header, 2.0mm pitch
Connector location: JP11

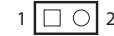

Pin	Definition
1	Reset
2	GND

SMBus

Connector type: 1x3 3-pin header, 2.0mm pitch

Connector location: JP2



Pin	Definition
1	SMB_CLK
2	SMB_DATA
3	GND

PS/2 Keyboard/Mouse Connector

Connector type: 2x4 8-pin header, 2.54mm pitch

Connector location: JP6

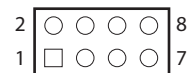

Pin	Definition	Pin	Definition
1	VCC5	2	VCC5
3	KDAT_R	4	MDAT_R
5	KCLK_R	6	MCLK_R
7	GND	8	GND

System Fan Connector

Connector type: 1x4 4-pin Wafer, 2.54mm pitch

Connector location: CN1

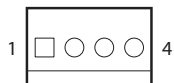

Pin	Definition
1	GND
2	12V
3	FANIN
4	FANOUT

GPIO Connector

Connector type: 2x5 10-pin header, 2.0mm pitch

Connector location: JP7

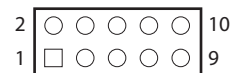

Pin	Definition	Pin	Definition
1	VCC5	2	GND
3	GPO0	4	GPIO
5	GPO1	6	GPI1
7	GPO2	8	GPI2
9	GPO3	10	GPI3

COM Port 1 (RS232)

Connector type: 1x10 10-pin Wafer, 1.0mm pitch

Connector location: J6

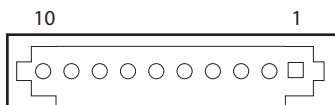

Pin	Definition	Pin	Definition
1	DCD1	2	RXD1
3	TXD1	4	DTR1
5	GND	6	DSR1
7	RTS1	8	CTS1
9	RI1	10	GND

COM Port 2 (RS232/RS422/RS485)

Connector type: 1x10 10-pin header, 1.0mm pitch

Connector location: J4

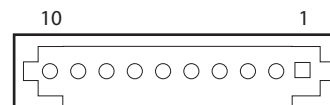

Pin	Definition	Pin	Definition
1	DCD2	2	RXD2
3	TXD2	4	DTR2
5	GND	6	DSR2
7	RTS2	8	CTS2
9	RI2	10	GND

COM Port 3 (RS232)

Connector type: 1x10 10-pin header, 1.0mm pitch

Connector location: J5

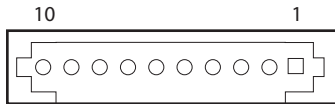

Pin	Definition	Pin	Definition
1	DCD3	2	RXD3
3	TXD3	4	DTR3
5	GND	6	DSR3
7	RTS3	8	CTS3
9	RI3	10	GND

COM Port 4 (RS232)

Connector type: 1x10 10-pin header, 1.0mm pitch

Connector location: J7

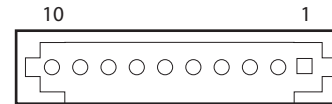

Pin	Definition	Pin	Definition
1	DCD4	2	RXD4
3	TXD4	4	DTR4
5	GND	6	DSR4
7	RTS4	8	CTS4
9	RI4	10	GND

Mic-in Connector

Connector type: 1x4 4-pin header, 2.0mm pitch

Connector location: JP9



Pin	Definition
1	MIC1_L
2	GND
3	MIC_JD
4	MIC1_R

Line-out Connector

Connector type: 1x4 4-pin header, 2.0mm pitch

Connector location: JP10



Pin	Definition
1	LOUT_L
2	GND
3	LOUT_JD
4	LOUT_R

Speaker-out Connector

Connector type: 1x5 5-pin header, 2.0mm pitch

Connector location: JP8



Pin	Definition	Pin	Definition
1	FRONT_L+	2	FRONT_L-
3	GND	4	FRONT_R+
5	FRONT_R		

LVDS Connector A

Connector type: 2x10 20-pin header, 1.25mm pitch

Connector location: CN4



Pin	Definition	Pin	Definition
1	LVDS_DDC_CLK	2	LVDS_DDC_DATA
3	Panel_VDD	4	LVDSA_DATA0
5	LVDSA_DATA3	6	LVDS_DATA#0
7	LVDSA_DATA#3	8	Panel_VDD
9	GND	10	LVDSA_DATA1
11	LVDSA_CLK	12	LVDSA_DATA#1
13	LVDSA_CLK#	14	GND
15	GND	16	Panel Inverter 12V
17	LVDSA_DATA2	18	Panel_backlight
19	LVDSA_DATA#2	20	GND

LVDS Connector B

Connector type: 2x10 20-pin header, 1.25mm pitch
Connector location: CN6

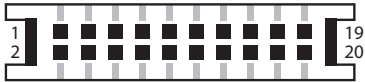

Pin	Definition	Pin	Definition
1	LVDS_DDC_CLK	2	LVDS_DDC_DATA
3	Panel_VDD	4	LVDSB_DATA0
5	LVDSB_DATA3	6	LVDSB_DATA#0
7	LVDSB_DATA#3	8	Panel_VDD
9	GND	10	LVDSB_DATA1
11	LVDSB_CLK	12	LVDSB_DATA#1
13	LVDSB_CLK#	14	GND
15	GND	16	Panel Inverter 12V
17	LVDSB_DATA2	18	Panel_backlight
19	LVDSB_DATA#2	20	GND

LVDS Panel Inverter Connector

Connector type: 1x7 JST, 7-pin header, 2.0mm pitch
Connector location: J1

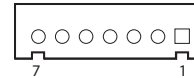

Pin	Definition	Pin	Definition
1	VCC5	2	+12V
3	+12V	4	Panel Backlight Brightness Control
5	GND	6	GND
7	Panel Backlight Enable		

Mini-PCIe Slot (Wi-Fi)

Connector location: CN7

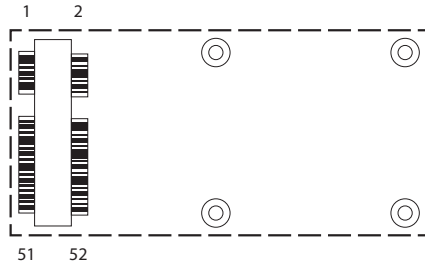

Pin	Definition	Pin	Definition
1	WAKE#	2	+3VSB
3	NC	4	GND
5	NC	6	+1.5V
7	CLKREQ#	8	NC
9	GND	10	NC
11	REF CLK-	12	NC
13	REF CLK+	14	NC
15	GND	16	NC
17	NC	18	GND
19	NC	20	Disable#
21	GND	22	PERST#
23	PCIERX1N	24	+3VSB
25	PCIERX1P	26	GND

Pin	Definition	Pin	Definition
27	GND	28	+1.5V
29	GND	30	SMBCLK
31	PCIETX-	32	SMBDATA
33	PCIETX+	34	GND
35	GND	36	USB_ON
37	GND	38	USB_OP
39	+3VSB	40	GND
41	+3VSB	42	NC
43	GND	44	NC
45	NC	46	NC
47	NC	48	+1.5V
49	NC	50	GND
51	NC	52	+3VSB

Mini-PCIe Slot (3G)

Connector location: CN10

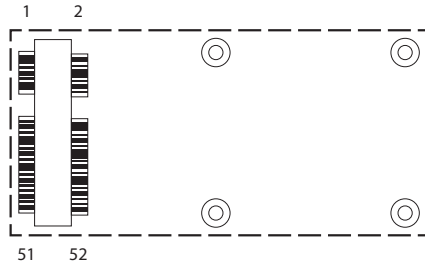

Pin	Definition	Pin	Definition
1	WAKE#	2	+3VSB
3	NC	4	GND
5	NC	6	+1.5V
7	CLKREQ#	8	UIM_PWR
9	GND	10	UIM_DATA
11	REF CLK-	12	UIM_CLK
13	REF CLK+	14	UIM_RESET
15	GND	16	UIM_VPP
17	NC	18	GND
19	NC	20	Disable#
21	GND	22	PERST#
23	PCIERX1N	24	+3VSB
25	PCIERX1P	26	GND

Pin	Definition	Pin	Definition
27	GND	28	+1.5V
29	GND	30	SMBCLK
31	PCIETX-	32	SMBDATA
33	PCIETX+	34	GND
35	GND	36	USB_1N
37	GND	38	USB_1P
39	+3VSB	40	GND
41	+3VSB	42	NC
43	GND	44	NC
45	NC	46	NC
47	NC	48	+1.5V
49	NC	50	GND
51	NC	52	+3VSB

SIM Card Connector

Connector type: SIM card slot and 2x3 6-pin header, 2.0mm pitch

Connector location: CN9 and JP5 (co-layout)

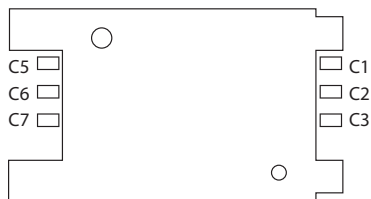

CN7

Pin	Definition	Pin	Definition
C1	UIM_PWR	C2	UIM_RESET
C3	UIM_CLK	C5	GND
C6	UIM_VPP	C7	UIM_DATA

JP5

Pin	Definition	Pin	Definition
1	UIM_PWR	2	GND
3	UIM_RESET	4	UIM_VPP
5	UIM_CLK	6	UIM_DATA

SATA Connector A

Connector type: Standard Serial ATA 7P (1.27mm, SATA-M-180)

Connector location: CN3

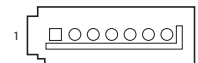

Pin	Definition	Pin	Definition
1	GND	2	SATA_TXP0
3	SATA_TXN0	4	GND
5	SATA_RXN0	6	SATA_RXP0
7	GND		

SATA DOM Connector

Connector type: Standard Serial ATA 7P (1.27mm, SATA-M-180)

Connector location: CN5

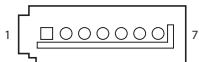

Pin	Definition	Pin	Definition
1	GND	2	SATA_TXP1
3	SATA_TXN1	4	GND
5	SATA_RXN1	6	SATA_RXP1
7	GND		

SATA Power Connector

Connector type: 1x4 4-pin Wafer, 2.54mm pitch

Connector location: CN2

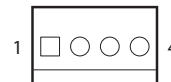

Pin	Definition
1	12V
2	GND
3	GND
4	VCC5

SATA DOM Power Connector

Connector type: 1x2 JST, 2-pin header, 2.5mm pitch
Connector location: J2



Pin	Definition
1	VCC5
2	GND

Power/HDD LED Connector

Connector type: 2x2 4-pin header, 2.0mm pitch
Connector location: JP4

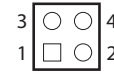

Pin	Definition
1	PWRLEDP
2	GND
3	HDDLEDP
4	GND

Block Diagram

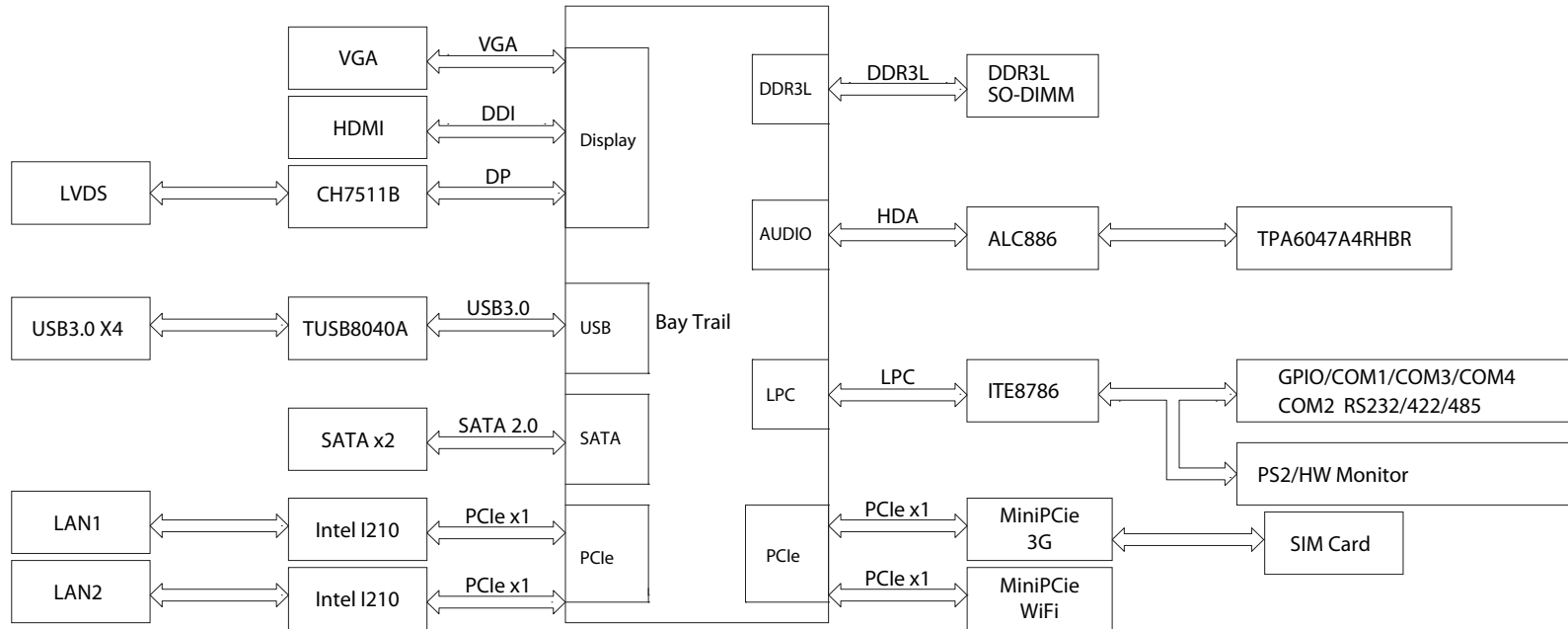

Chapter 3: BIOS Setup

This chapter describes how to use the BIOS setup program for the EBC 355. The BIOS screens provided in this chapter are for reference only and may change if the BIOS is updated in the future.

To check for the latest updates and revisions, visit the NEXCOM Web site at www.nexcom.com.tw.

About BIOS Setup

The BIOS (Basic Input and Output System) Setup program is a menu driven utility that enables you to make changes to the system configuration and tailor your system to suit your individual work needs. It is a ROM-based configuration utility that displays the system's configuration status and provides you with a tool to set system parameters.

These parameters are stored in non-volatile battery-backed-up CMOS RAM that saves this information even when the power is turned off. When the system is turned back on, the system is configured with the values found in CMOS.

With easy-to-use pull down menus, you can configure such items as:

- Hard drives, diskette drives, and peripherals
- Video display type and display options
- Password protection from unauthorized use
- Power management features

The settings made in the setup program affect how the computer performs. It is important, therefore, first to try to understand all the setup options, and second, to make settings appropriate for the way you use the computer.

When to Configure the BIOS

This program should be executed under the following conditions:

- When changing the system configuration
- When a configuration error is detected by the system and you are prompted to make changes to the setup program
- When resetting the system clock
- When redefining the communication ports to prevent any conflicts
- When making changes to the Power Management configuration
- When changing the password or making other changes to the security setup

Normally, CMOS setup is needed when the system hardware is not consistent with the information contained in the CMOS RAM, whenever the CMOS RAM has lost power, or the system features need to be changed.

Default Configuration

Most of the configuration settings are either predefined according to the Load Optimal Defaults settings which are stored in the BIOS or are automatically detected and configured without requiring any actions. There are a few settings that you may need to change depending on your system configuration.

Entering Setup

When the system is powered on, the BIOS will enter the Power-On Self Test (POST) routines. These routines perform various diagnostic checks; if an error is encountered, the error will be reported in one of two different ways:

- If the error occurs before the display device is initialized, a series of beeps will be transmitted.
- If the error occurs after the display device is initialized, the screen will display the error message.

Powering on the computer and immediately pressing allows you to enter Setup. Another way to enter Setup is to power on the computer and wait for the following message during the POST:

TO ENTER SETUP BEFORE BOOT PRESS + +

Press the key to enter Setup:

Legends

Key	Function
	Moves the highlight left or right to select a menu.
	Moves the highlight up or down between sub-menu or fields.
	Exits the BIOS Setup Utility.
	Scrolls forward through the values or options of the highlighted field.
	Scrolls backward through the values or options of the highlighted field.
	Selects a field.
	Displays General Help.
	Load previous values.
	Load optimized default values.
	Saves and exits the Setup program.
	Press <Enter> to enter the highlighted sub-menu

Scroll Bar

When a scroll bar appears to the right of the setup screen, it indicates that there are more available fields not shown on the screen. Use the up and down arrow keys to scroll through all the available fields.

Submenu

When “▶” appears on the left of a particular field, it indicates that a submenu which contains additional options are available for that field. To display the submenu, move the highlight to that field and press  .

BIOS Setup Utility

Once you enter the AMI BIOS Setup Utility, the Main Menu will appear on the screen. The main menu allows you to select from several setup functions and one exit. Use arrow keys to select among the items and press  to accept or enter the submenu.

Main

The Main menu is the first screen that you will see when you enter the BIOS Setup Utility.

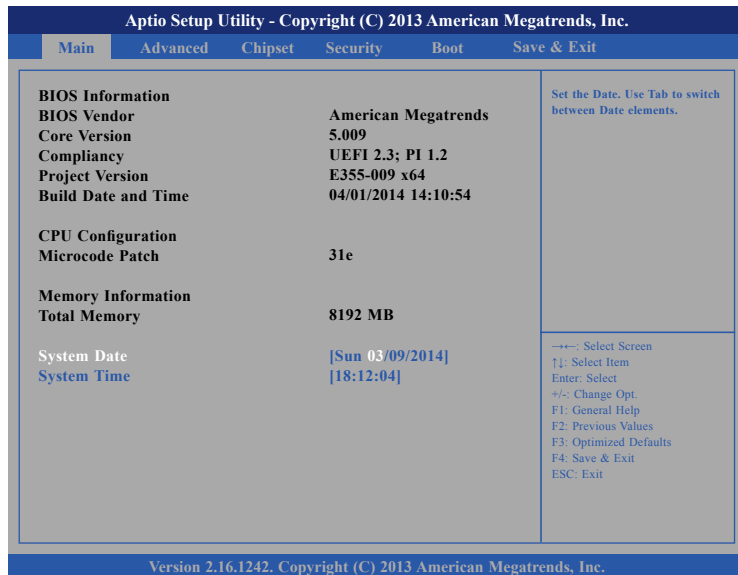

Advanced

The Advanced menu allows you to configure your system for basic operation. Some entries are defaults required by the system board, while others, if enabled, will improve the performance of your system or let you set some features according to your preference.



Setting incorrect field values may cause the system to malfunction.



IT8786E Super IO Configuration

This section is used to configure the serial ports.

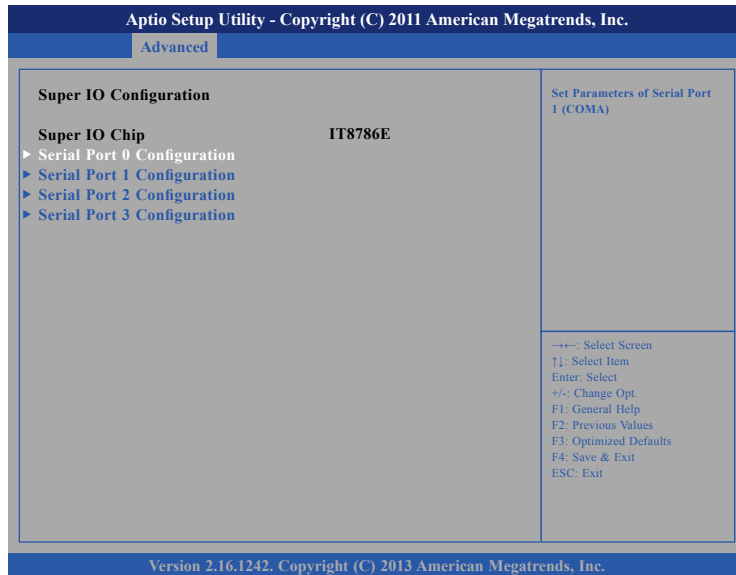

Super IO Chip

Displays the Super I/O chip used on the board.

Serial Port 1 Configuration

This section is used to configure serial port 1.

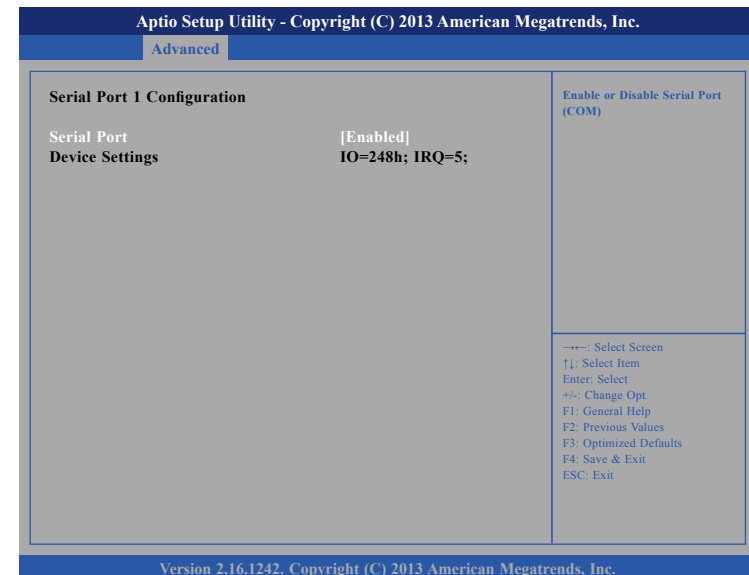

Serial Port

Enables or disables the serial port.

Change Settings

Selects an optimal setting for the Super IO device.

Onboard Serial Port Max Baud Rate

Select this to change the max baud rate of the serial port.

Serial Port 2 Configuration

This section is used to configure serial port 2.



Serial Port

Enables or disables the serial port.

Onboard Serial Port Mode

Select this to change the serial port mode to RS232, RS422 or RS485.

Serial Port 3 Configuration

This section is used to configure serial port 3.

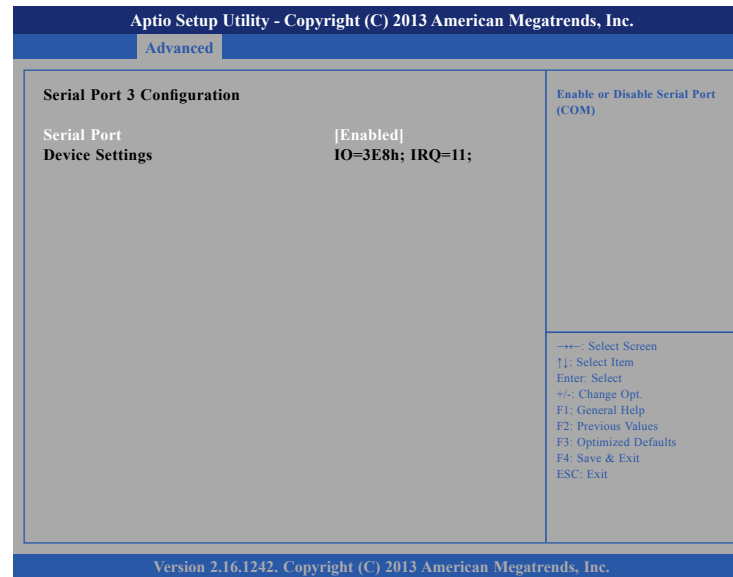

Serial Port

Enables or disables the serial port.

Serial Port 4 Configuration

This section is used to configure serial port 4.

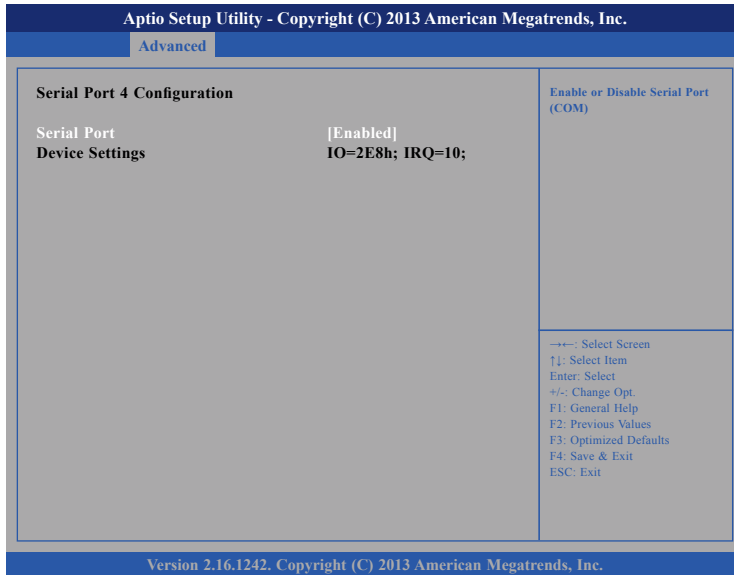

Serial Port

Enables or disables the serial port.

Hardware Monitor

This section is used to monitor hardware status such as temperature, fan speed and voltages.

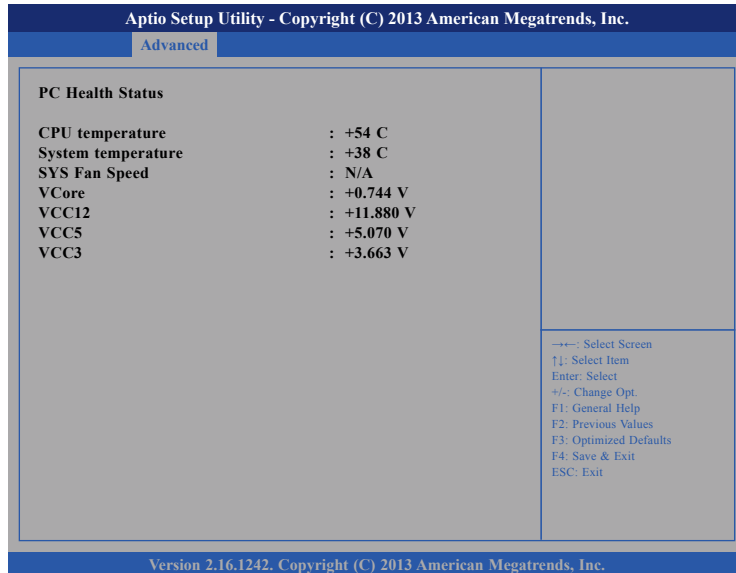

The screenshot shows the 'Advanced' tab of the Aptio Setup Utility. The 'PC Health Status' section displays the following values:

CPU temperature	: +54 C
System temperature	: +38 C
SYS Fan Speed	: N/A
VCore	: +0.744 V
VCC12	: +11.880 V
VCC5	: +5.070 V
VCC3	: +3.663 V

Navigation instructions are listed in the bottom right corner of the screen:

- ←→: Select Screen
- ↑↓: Select Item
- Enter: Select
- +/-: Change Opt.
- F1: General Help
- F2: Previous Values
- F3: Optimized Defaults
- F4: Save & Exit
- ESC: Exit

Version 2.16.1242. Copyright (C) 2013 American Megatrends, Inc.

VCore

Detects and displays the Vcore CPU voltage.

VCC12

Detects and displays 12V voltage.

VCC5

Detects and displays 5V voltage.

VCC3

Detects and displays 3.3V voltage.

CPU Temperature

Detects and displays the current CPU temperature.

System Temperature

Detects and displays the current system temperature.

SYS Fan Speed

Detects and displays the system fan speed.

CPU Configuration

This section is used to configure the CPU.



Active Processor Cores

Select the number of cores to enable in each processor package.

Limit CPUID Maximum

The CPUID instruction of some newer CPUs will return a value greater than 3. The default is Disabled because this problem does not exist in the Windows series operating systems. If you are using an operating system other than Windows, this problem may occur. To avoid this problem, enable this field to limit the return value to 3 or lesser than 3.

Execute Disable Bit

When this field is set to Disabled, it will force the XD feature flag to always return to 0. XD can prevent certain classes of malicious buffer overflow attacks when combined with a supporting OS (Windows Server 2003 SP1, Windows XP SP2, SuSE Linux 9.2, RedHat Enterprise 3 Update 3).

Intel® Virtualization Technology

When this field is set to Enabled, the VMM can utilize the additional hardware capabilities provided by Vanderpool Technology.

PPM Configuration

This section is used to configure Intel® PPM configuration.

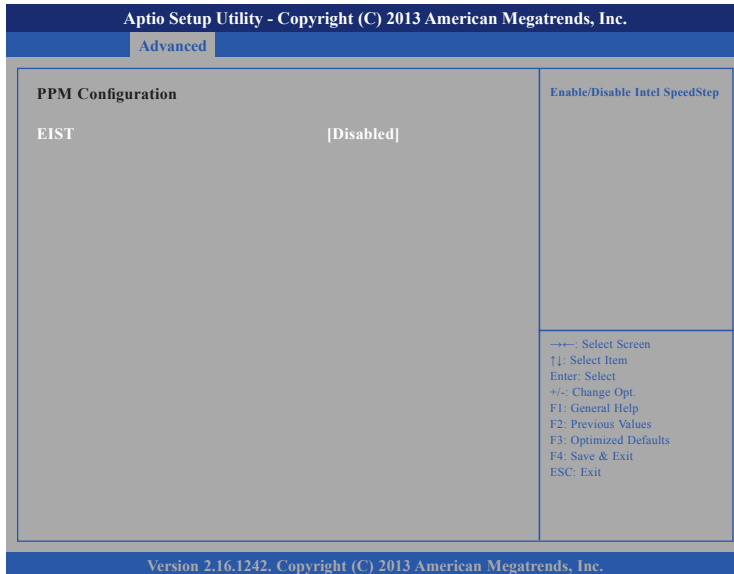

EIST

Enables or disables Intel® SpeedStep.

IDE Configuration

This section is used to configure the SATA drives.

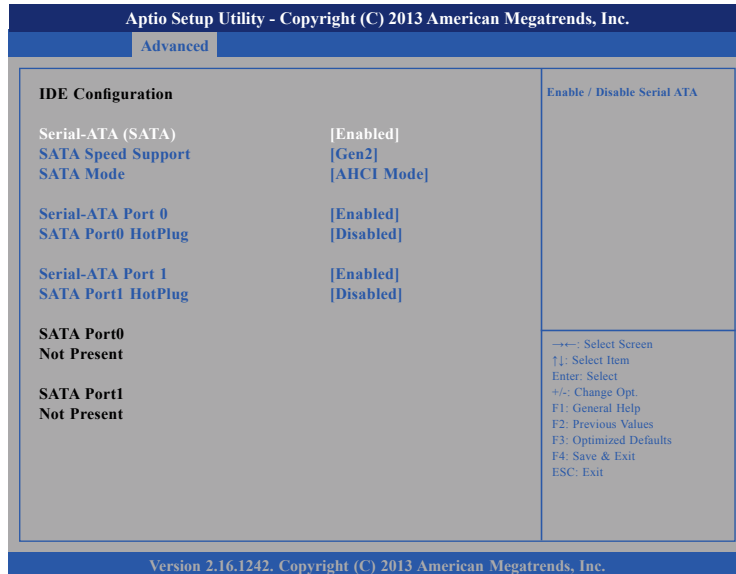

Serial-ATA (SATA)

Enables or disables the SATA device.

SATA Speed Support

Configures the SATA controller to Gen1 or Gen2 speed.

Configure SATA As

Configures the SATA as IDE, AHCI or RAID mode.

- IDE This option configures the Serial ATA drives as Parallel ATA physical storage device.
- RAID This option allows you to create RAID or Intel Matrix Storage configuration on Serial ATA devices.
- AHCI This option configures the Serial ATA drives to use AHCI (Advanced Host Controller Interface). AHCI allows the storage driver to enable the advanced Serial ATA features which will increase storage performance.

Serial-ATA Port 0 and Serial-ATA Port 1

Enables or disables SATA port 0 and SATA port 1.

SATA Port1 Hotplug and SATA Port2 Hotplug

Enables or disables hotplug support on SATA port 1 and SATA port 2.

USB Configuration

This section is used to configure the USB.



Legacy USB Support

Enable Enables Legacy USB.
 Auto Disables support for Legacy when no USB devices are connected.
 Disable Keeps USB devices available only for EFI applications.

USB3.0 Support

Enables or disables USB 3.0 controller support.

XHCI Hand-off and EHCI Hand-off

This is a workaround for OSs that does not support XHCI hand-off and EHCI Hand-off. The XHCI and EHCI ownership change should be claimed by the XHCI and EHCI driver respectively.

Chipset

This section gives you functions to configure the system based on the specific features of the chipset. The chipset manages bus speeds and access to system memory resources.

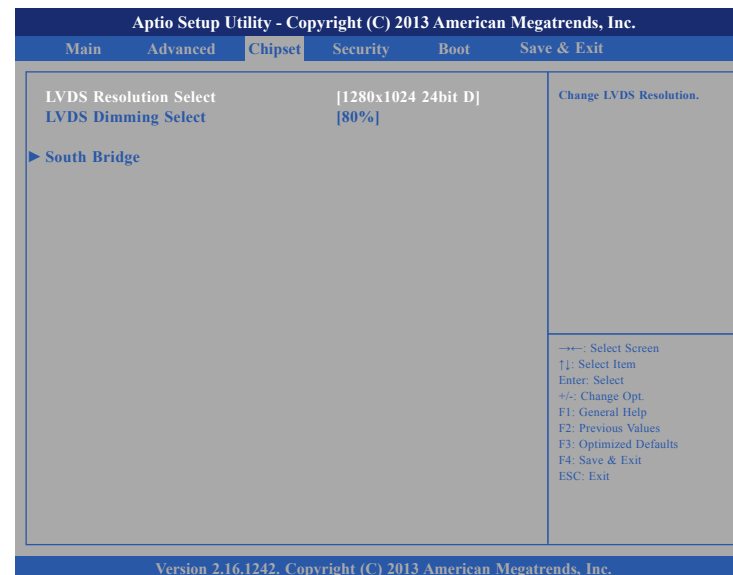

LVDS Resolution Select

Configures the resolution of the LVDS.

LVDS Dimming Select

Adjusts the brightness of the LVDS backlight.

South Bridge

This section is used to configure the south bridge features.

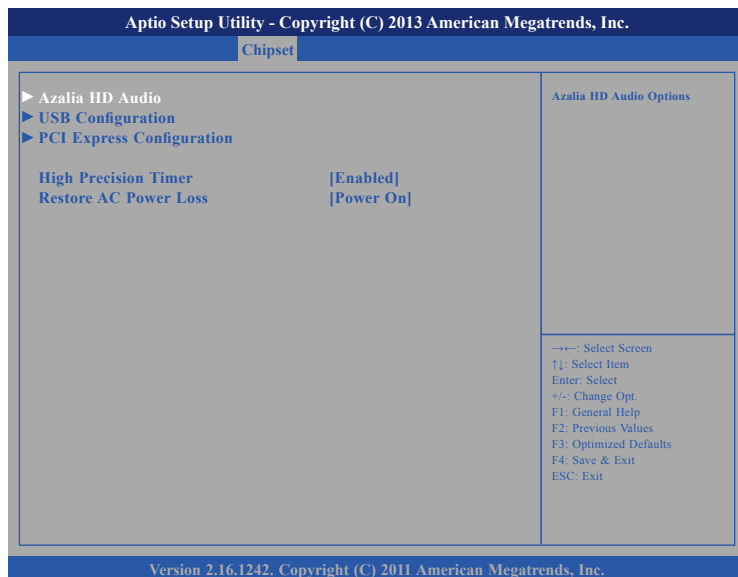

High Precision Timer

Enables or disables the high precision event timer.

Restore AC Power Loss

- | | |
|------------|--|
| Power Off | When power returns after an AC power failure, the system's power is off. You must press the Power button to power-on the system. |
| Power On | When power returns after an AC power failure, the system will automatically power-on. |
| Last State | When power returns after an AC power failure, the system will return to the state where you left off before power failure occurs. If the system's power is off when AC power failure occurs, it will remain off when power returns. If the system's power is on when AC power failure occurs, the system will power-on when power returns. |

PCH Azalia Configuration



Azalia

Control detection of the Azalia device.

Disabled Azalia will be unconditionally disabled.
 Enabled Azalia will be unconditionally Enabled.

Azalia HDMI Codec

Enables or disables internal HDMI codec for Azalia.

USB Configuration



XHCI Mode

Enables or disables XHCI mode.

USB2 Link Power Management

Enables or disables USB link power management.

PCI Express Configuration

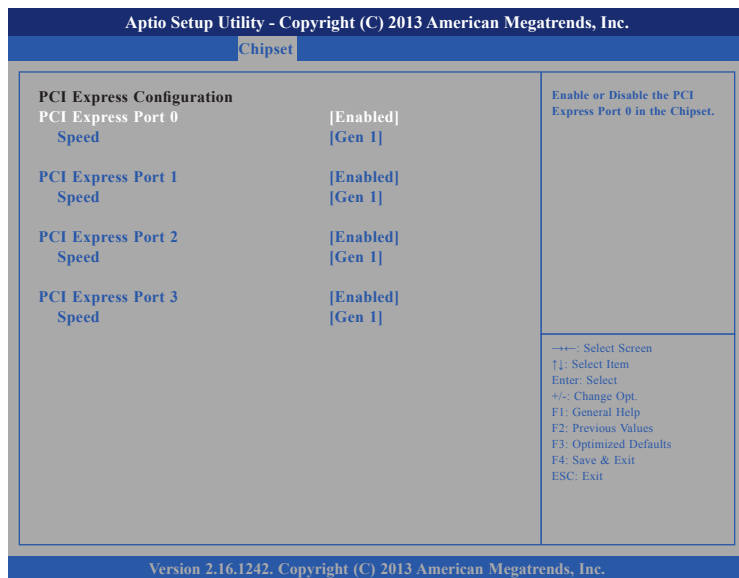

PCI Express Port 0 to PCI Express Port 3

Enables or disables the PCI Express ports 0 to 3 on the chipset.

Speed

Configures the PCI Express speed of ports 0 to 3.

Security



Administrator Password

Select this to reconfigure the administrator's password.

User Password

Select this to reconfigure the user's password.

Boot

This section is used to configure the boot features.

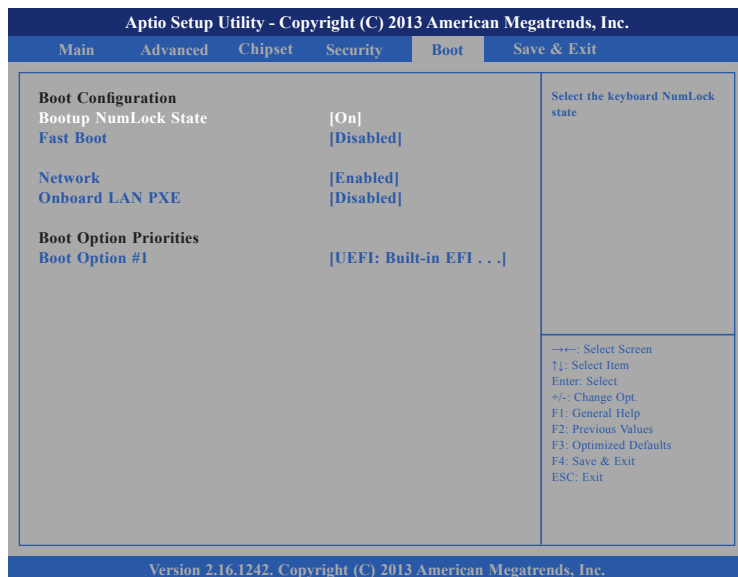

Bootup NumLock State

This allows you to determine the default state of the numeric keypad. By default, the system boots up with NumLock on wherein the function of the numeric keypad is the number keys. When set to Off, the function of the numeric keypad is the arrow keys.

Fast Boot

When enabled, the BIOS will shorten or skip some check items during POST. This will decrease the time needed to boot the system.

Network

Controls the execution of UEFI and legacy PXE OpROM.

Onboard LAN PXE

Enables or disables onboard LAN PXE ROM.

Boot Option Priorities

Adjust the boot sequence of the system. Boot Option #1 is the first boot device that the system will boot from, next will be #2 and so forth.

Save & Exit



Save Changes and Reset

To save the changes and reset, select this field then press <Enter>. A dialog box will appear. Confirm by selecting Yes.

Discard Changes and Reset

To exit the Setup utility without saving the changes, select this field then press <Enter>. You may be prompted to confirm again before exiting.

Restore Defaults

To restore the BIOS to default settings, select this field then press <Enter>. A dialog box will appear. Confirm by selecting Yes.

Appendix A: Watchdog Timer Setting

EBC 355 WatchDog Programming Guide

```
#define SUPERIO_PORT    0x2E
#define WDT_SET        0x72
#define WDT_VALUE      0x73

void main(void)
{
    #Enter SuperIO Configuration
    outputb(SUPERIO_PORT, 0x87);
    outputb(SUPERIO_PORT, 0x01);
    outputb(SUPERIO_PORT, 0x55);
    outputb(SUPERIO_PORT, 0x55);

    # Set LDN
    outputb(SUPERIO_PORT, 0x07);
    outputb(SUPERIO_PORT+1 ,0x07);

    # Set WDT setting
    outputb(SUPERIO_PORT, WDT_SET);
    outputb(SUPERIO_PORT+1, 0x90);           # Use the second
                                           # Use the minute, change value to 0x40

    # Set WDT sec/min
    outputb(SUPERIO_PORT, WDT_VALUE);
    outputb(SUPERIO_PORT+1, 0x05);         #Set 5 seconds
}
```

Appendix B: GPIO Programming Guide

GPIO (General Purpose Input/Output) pins are provided for custom system design. This appendix provides definitions and its default setting for the ten GPIO pins. The pin definition is shown in the following table:

Pin	GPIO mode	PowerOn Default	Address	Pin	GPIO mode	PowerOn Default	Address
1	VCC	-	-	2	GND	-	-
3	GPO0	Low	A03h (Bit6)	4	GPIO	High	A03h (Bit1)
5	GPO1	Low	A02h (Bit5)	6	GPI1	High	A05h (Bit5)
7	GPO2	Low	A07h (Bit0)	8	GPI2	High	A05h (Bit4)
9	GPO3	Low	A07h (Bit1)	10	GPI3	High	A00h (Bit1)

Control the GPIO pin 3 level from I/O port A03h bit 6.

Control the GPIO pin 5 level from I/O port A02h bit 5.

Control the GPIO pin 7 level from I/O port A07h bit 0.

Control the GPIO pin 9 level from I/O port A07h bit 1.

The bit is Set/Clear indicated output High/Low.