

SPECIFICATIONS:

ELECTRICAL:

CURRENT RATING: 1 AMPS
 INSULATION RESISTANCE: 1,000 MΩ MIN. @ 500 VDC
 DIELECTRIC WITHSTANDING VOLTAGE: 1,000 VAC FOR 1 MINUTE
 CONTACT RESISTANCE: 30 mΩ MAX.
 OPERATING TEMPERATURE: -55°C TO +105°C

MATERIALS:

INSULATION: PBT, UL 94 V-O RATED
 CONTACTS: PHOSPHOR BRONZE
 CONTACT PLATING: GOLD FLASH IN MATING AREA
 BRIGHT TIN IN SOLDER AREA
 SHELL: STEEL, NICKEL PLATED

DIMENSIONS(mm)			
SIZE	A	B±0.25	C±0.25
14	43.90±0.25	36.00	25.20
24	54.70±0.25	46.80	36.30
36	67.75±0.30	59.74	49.00
50	83.10±0.30	74.85	64.47

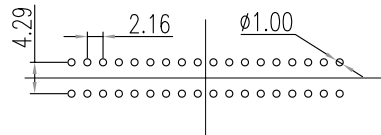
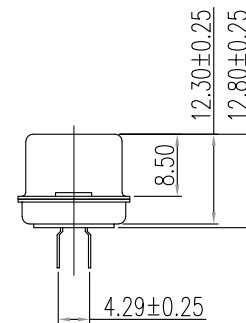
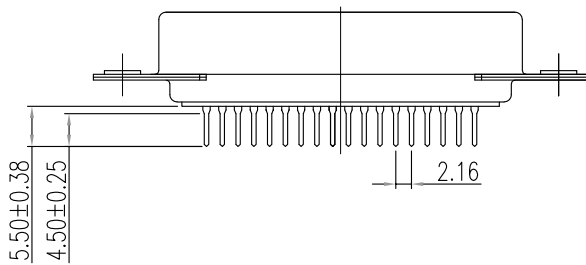
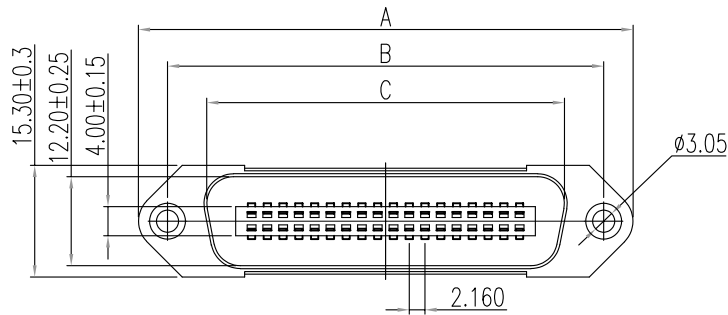

RECOMMENDED P.C.B LAYOUT

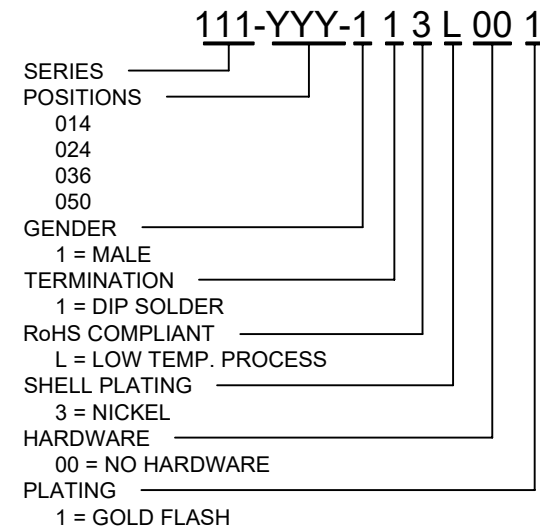

RoHS COMPLIANT

UNITS = mm

DO NOT SCALE FROM DRAWING



THESE DRAWINGS AND SPECIFICATIONS ARE THE PROPERTY OF NorComp AND SHALL NOT BE REPRODUCED, COPIED OR USED AS THE BASIS FOR THE MANUFACTURE OR SALE OF APPARATUS WITHOUT WRITTEN PERMISSION.

DRAWN:
WAYNE ROBBINS

DATE:
09/21/1998

NorComp

SCALE:
NTS

SHEET OF
1 2

REV
11

DWG NO.

111-YYY-113L001

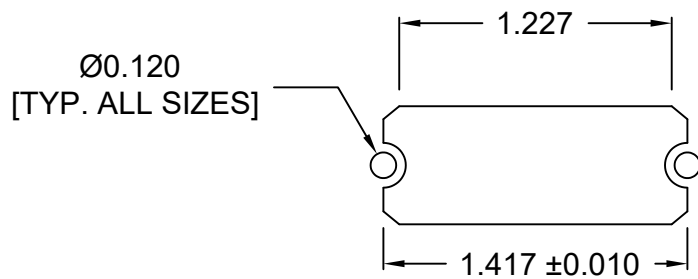

14 POSITION

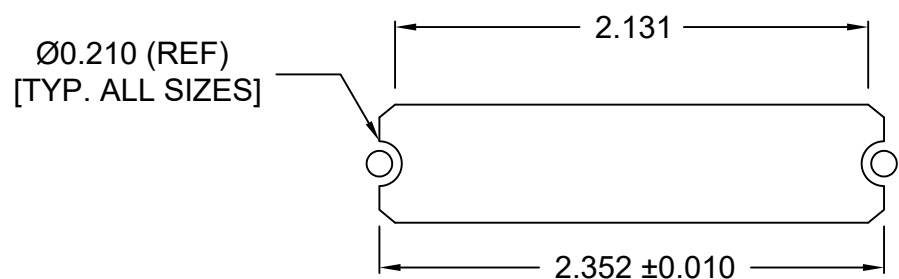

36 POSITION

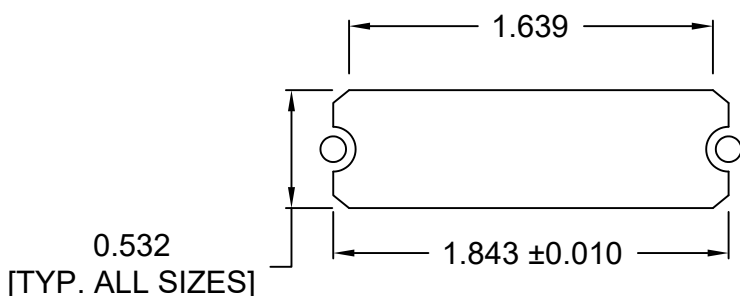

24 POSITION

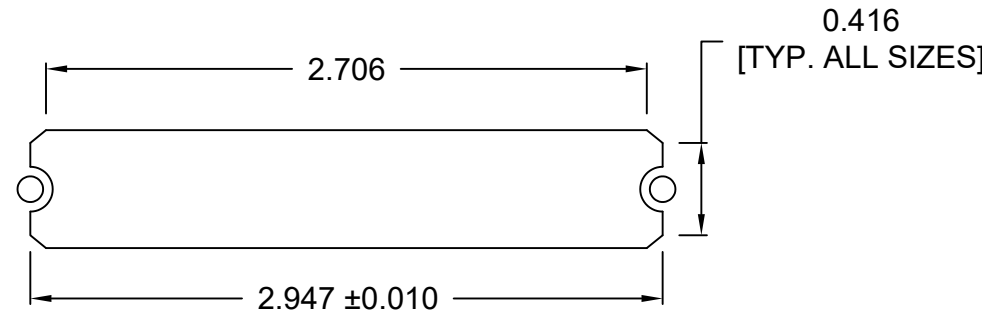

50 POSITION

RoHS COMPLIANT

UNITS = inch

DO NOT SCALE FROM DRAWING



THESE DRAWINGS AND SPECIFICATIONS ARE THE PROPERTY OF NorComp AND SHALL NOT BE REPRODUCED, COPIED OR USED AS THE BASIS FOR THE MANUFACTURE OR SALE OF APPARATUS WITHOUT WRITTEN PERMISSION.

DRAWN:
WAYNE ROBBINS
DATE:
09/21/1998

NorComp

SCALE: NTS	SHEET 2	OF 2	REV 11
DWG NO.		111-YYY-113L001	