

## General Description

Delta type N connectors are medium size, 50 Ω impedance connectors with 5/8"-24 threaded coupling. They are best suited for use with cables in the range of .350" to .450" diameter, but are available for other cables with diameters from .100" to over 1". Many of our N connectors are available as MIL-PRF-39012 QPL versions, and adapters as MIL-PRF-55339 versions. These types are listed starting on page 190. Our extensive line of type N receptacles includes configurations for virtually any packaging requirement, and we can supply any adapter or accessory you need to complete your system design. Adapters between type N and other series are shown starting on page 176.

As with our other connector series, Delta's customer-driven design results in N series connectors with practical and unique features that make your design and assembly process easier. Some of these include:

- Heli-Grip cable connectors for fast, reliable assembly to flexible cable without special tooling.
- One-Step cable connectors for quick, accurate assembly to semi-rigid cable.
- PressMount receptacles (page 85) mount securely in a single round hole, saving space on your components and reducing your housing fabrication costs.
- Panel receptacles with flange sizes to match the same hole pattern as standard SMA or BNC/TNC connectors, letting you drill one hole pattern and mount BNC, N, SMA, TNC, or 7/16 series connectors as needed.
- 70 Ω impedance N connectors (see page 89) for matched-impedance applications.

Our N series product line is still growing, so please call if you don't see what you need.

## N Configurations

Straight Cable Plugs .....	2	Dummy Receptacles .....	16
Right Angle Cable Plugs .....	5	Right Angle Panel Jack Receptacles .....	16
Tee Cable Plugs .....	6	Panel Plug Receptacles.....	17
Straight Cable Jacks .....	6	Bulkhead Jack Receptacles .....	18
Bulkhead Cable Jacks .....	8	Stripline Receptacles .....	18
Tee Bulkhead Cable Jacks .....	9	PressMount Receptacles.....	19
Panel Cable Jacks .....	11	Resistive Terminations .....	20
Panel Jack Receptacles (square flange) .....	12	Dust Caps .....	20
Panel Jack Receptacles (round flange) .....	12	In-Series Adapters .....	21

## N Specifications\*

### Electrical:

Nominal Impedance: 50 ohms.

Frequency Range: DC–11 GHz.

Voltage Rating: 1,000 volts RMS.

Dielectric Withstanding Voltage: 2,500 volts RMS.

Insulation Resistance: 5,000 megohms.

### Materials/Finishes:

Insulators: Teflon per ASTM D1710.

Male Contacts: Brass per ASTM B16.

Female Contacts: Beryllium Copper per ASTM B196.

Contact Plating: Silver per ASTM B700, or

Gold per MIL-DTL-45204.

Gaskets: Silicone rubber per ZZ-R-765, Class II, Grade 50.

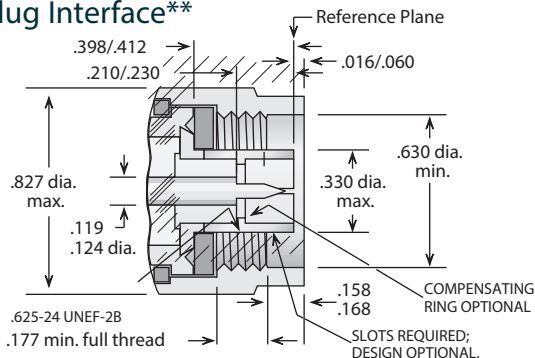
Other Metal Parts: Brass per ASTM B16, plated:

Silver per ASTM B700, or

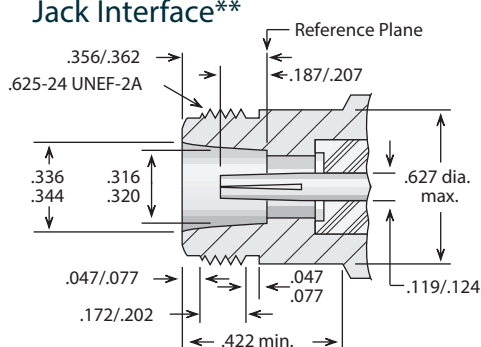
Nickel per AMS-QQ-N-290.

All other specifications are in accordance with the latest issues of MIL-PRF-39012, or MIL-A-55339, or other applicable MIL specifications, and interfaces are in accordance with MIL-STD-348.

### Plug Interface\*\*



### Jack Interface\*\*



\*These specifications are typical and may not apply to all connectors. Detailed specifications for individual connectors are available on request.

\*\*Some proportions altered to illustrate detail.

## Straight Plug - Military Clamp For Flexible Cable

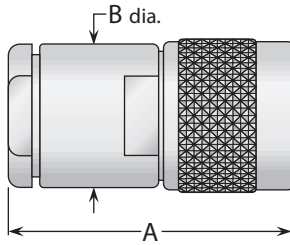


Figure 1

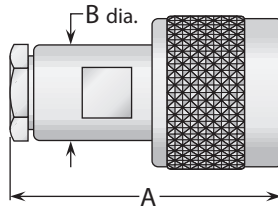


Figure 2

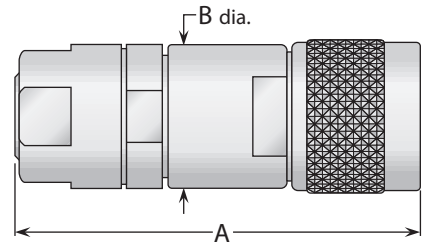
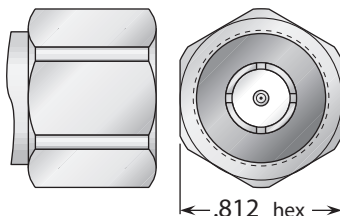


Figure 3  
(Includes armor clamp)

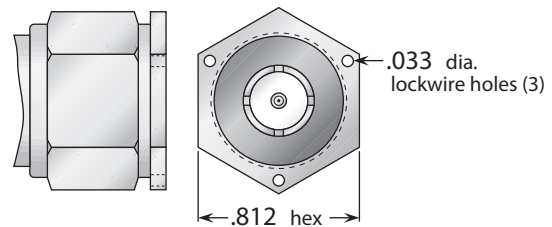
Cable Group	Figure	Dimensions		Plating		Delta P/N	Assembly Procedure/ Trim Code
		A	B	Body	Contact		
1	1	1.50	.750	Nickel	Silver	UG-18E/U	A/01
1	1	1.50	.750	Nickel	Silver (C)	1101001N001-000	A/01
2, 3	1	1.80	.680	Nickel	Silver	UG-21B/U	C/01
2, 3	1	1.50	.750	Nickel	Gold	UG-21D/U	A/01
2, 3	1	1.50	.750	Nickel	Gold	UG-21E/U	A/01
2, 3	1	1.50	.750	Nickel	Gold	UG-21G/U	A/01
2, 3	1	1.50	.750	Nickel	Silver (C)	UG-1185/U	A/01
2, 3	1	1.50	.750	Nickel	Gold (C)	UG-1185A/U	A/01
2, 3	1	1.50	.750	Silver	Gold (C)	M39012/01-0005 *	A/01
5, 6	2	1.41	.500	Nickel	Silver	UG-536B/U	A/02
5, 6	2	1.41	.500	Nickel	Gold	UG-536C/U	A/02
5, 6	2	1.41	.500	Nickel	Gold (C)	1101015N001-000	A/02
7	2	1.38	.500	Nickel	Silver	UG-603A/U	A/02
7	2	1.38	.500	Nickel	Silver (C)	1101021N001-000	A/02
8	2	1.41	.500	Nickel	Silver (C)	1101043N001-000	A/02
9	2	1.38	.500	Nickel	Silver	1101036N000-000	A/02
9	2	1.38	.500	Nickel	Silver (C)	1101036N001-000	A/02
15	3	2.42	.750	Nickel	Silver	UG-941B/U	D/01
15	3	2.42	.750	Silver	Gold (C)	M39012/01-0125 *	D/03
16	1	1.80	.880	Nickel	Silver	UG-204A/U	C/02
16	1	1.80	.880	Silver	Gold (C)	M39012/01-0015 *	A/01
20	3	3.09	1.31	Nickel	Silver	UG-557A/U	D/02
25	2	1.38	.500	Nickel	Silver	1101132N000-000	A/03

\* Lockwire holes in coupling nut.

## Optional Type N Coupling Nut Examples



13/16" hex coupling nut

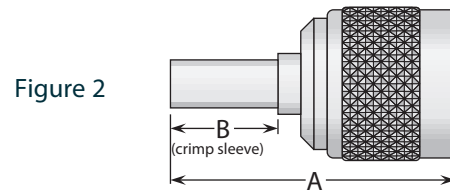
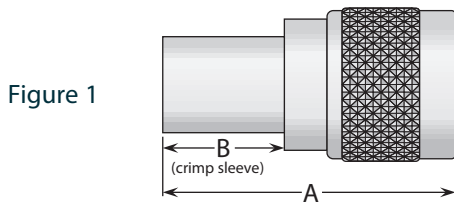


13/16" hex coupling nut with lockwire holes

These designs allow the connectors to be tightened with a wrench for precise torquing of mated parts, and can be supplied on any Delta type N plug. Please call for details of these options or any other special requirements you may have.

- See page 209 for cable groups.
- Assembly procedures start on page 210.
- (C) in contact plating column indicates captive contact.
- See page 6 for alternate body plating information.

## Straight Plug - Crimp Type For Flexible Cable



Cable Group	Figure	Dimensions		Plating		Delta P/N	Assembly Procedure/ Trim Code
		A	B	Body	Contact		
2	1	1.51	.630	Nickel	Silver	1103002N000-000	B/01
2	1	1.55	.630	Nickel	Gold (C)	1103002N001-009	B/03
2	1	1.55	.600	Silver	Gold (C)	M39012/01B0007 *	B/03
2	1	1.55	.600	Silver	Gold (C)	M39012/01-0502 *	B/03
2B	1	1.55	.630	Nickel	Silver	1103070N000-000	B/01
3A, 4	1	1.55	.630	Nickel	Gold (C)	1103004N001-001	B/03
3A, 4	1	1.51	.630	Nickel	Silver	1103005N000-000	B/01
3A, 3C, 4	1	1.55	.600	Silver	Gold (C)	M39012/01B0008 *	B/03
3A, 3C, 4	1	1.55	.600	Silver	Gold (C)	M39012/01-0501 *	B/03
4	1	1.50	.630	Nickel	Silver	1103079N000-000	B/01
5	2	1.43	.500	Nickel	Silver	1103017N000-000	B/04
5	1	1.48	.500	Nickel	Gold (C)	1103017N001-000	B/05
6	2	1.43	.500	Nickel	Silver	1103013N000-000	B/04
6	1	1.45	.500	Nickel	Gold (C)	1103018N001-000	B/03
6	1	1.45	.500	Silver	Gold (C)	M39012/01-0503 *	B/03
7	2	1.43	.500	Nickel	Silver	1103020N000-000	B/06
7	1	1.38	.500	Nickel	Gold (C)	1103020N001-000	B/03

\* Lockwire holes in coupling nut.

## Straight Plug - Heli-Grip® For Flexible Cable

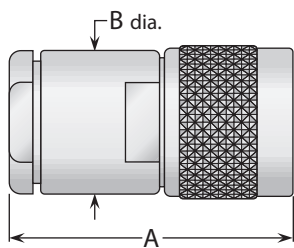


Figure 1

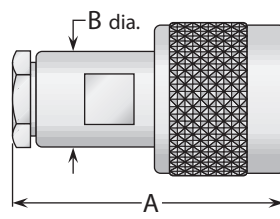
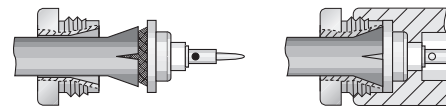


Figure 2

### Heli-Grip® Cable Attachment

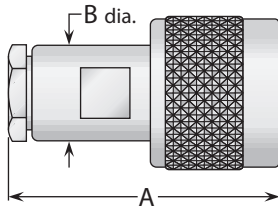


These connectors have captivated contacts and allow rapid, easy assembly—simply trim the cable, slide into the cone/insulator/contact assembly (left), solder the center conductor to the contact, and screw body assembly (right) onto cable assembly.

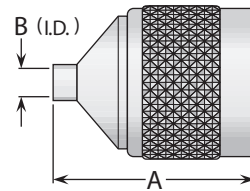
Cable Group	Figure	Dimensions		Plating		Delta P/N	Assembly Procedure/ Trim Code
		A	B	Body	Contact		
2	1	1.50	.750	Nickel	Gold (C)	1101004N005-000	E/01
3	1	1.50	.750	Nickel	Gold (C)	1101004N005-006	E/01
5, 6 <sup>s</sup>	2	1.41	.500	Nickel	Gold (C)	1101015N005-000	E/02
RG-223	2	1.41	.500	Nickel	Gold (C)	1101015N005-001	E/02
7	2	1.38	.500	Nickel	Gold (C)	1101021N005-000	E/02
24	1	1.50	.750	Nickel	Gold (C)	1101052N005-000	E/01
26	1	1.50	.750	Nickel	Gold (C)	1101108N005-000	E/01

• See page 209 for cable groups. • Assembly procedures start on page 210.  
• (C) in contact plating column indicates captive contact. • See page 6 for alternate body plating information.

## Straight Plug - For Semi-Rigid Cable

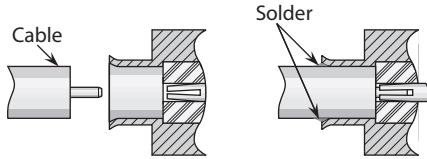


**Figure 1**  
(Solder-clamp; gold-plated ferrule, nickel-plated body)

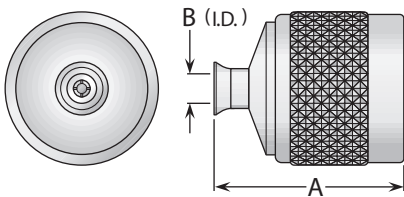


**Figure 2**  
(Direct solder; gold-plated body, nickel <sup>(1)</sup> or passivated <sup>(2)</sup> coupling nut)

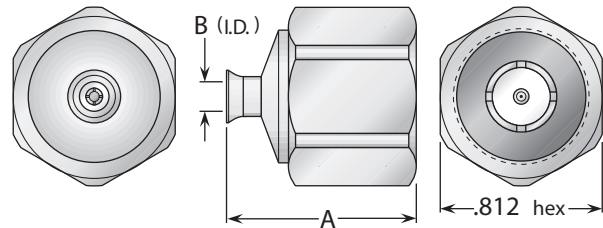
### Delta One-Step Cable Attachment Straight Plugs - For Semi-Rigid Cable



Delta "One-Step" connectors feature captivated contacts and insulators to allow rapid, easy assembly to semi-rigid cable—simply trim the cable jacket and dielectric flush, chamfer the center conductor, insert into the connector, and solder the jacket to the connector body.



**Figure 3**  
(One-Step cable attachment, standard coupling nut)



**Figure 4**  
(One-Step cable attachment, hex coupling nut)

Cable Group	Figure	Dimension		Plating		Delta P/N	Assembly Procedure/ Trim Code
		A	B	Body	Contact		
12	1	1.50	.500	Nickel	Silver	1101050N000-000	F/03
12	2	.960	.254	Mixed <sup>(1)</sup>	Silver	1101050N003-000	***
12	4	1.44	.254	Silver	Gold (C)	1101050A003-007	I/01
13	1	1.41	.500	Nickel	Silver	1101031N003-000	F/01
13	2	.960	.143	Mixed <sup>(1)</sup>	Gold	1101031N003-001	***
13	2	.960	.143	Mixed <sup>(2)</sup>	Gold	1101031K00M-000	***
13	3	.960	.143	Silver	Gold (C)	1101031A003-008	I/01
13	4	.960	.143	Silver	Gold (C)	1101031A003-012	I/01
14	1	1.41	.500	Nickel	Silver	1101025N003-000	F/02

<sup>(1)</sup> Brass body and coupling nut.

<sup>(2)</sup> Stainless steel body and coupling nut.

- See page 209 for cable groups.
- Assembly procedures start on page 210.
- \*\*\*Contact factory for cable assembly instructions.
- (C) in contact plating column indicates captive contact.
- See page 6 for alternate body plating information.

## Right Angle Plug - Military Clamp For Flexible Cable

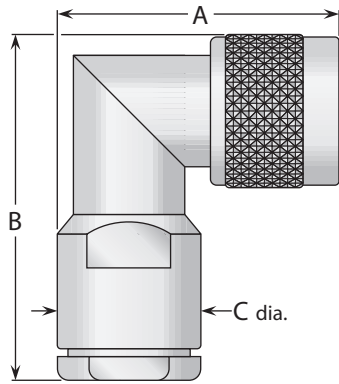


Figure 1  
(Mitered body)

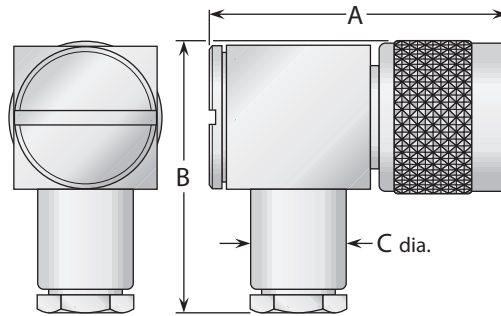


Figure 2  
(Cube body with access cap)

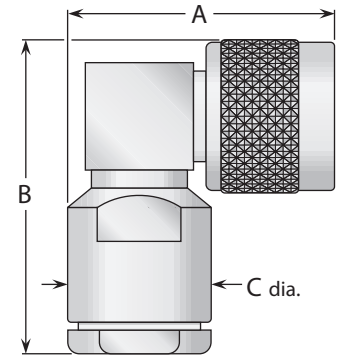


Figure 3  
(Cube body)

Cable Group	Figure	Dimensions			Plating		Delta P/N	Assembly Procedure/ Trim Code
		A	B	C	Body	Contact		
2, 3	1	1.47	1.88	.750	Nickel	Silver (C)	UG-594B/U	A/01
2, 3	3	1.36	1.66	.750	Silver	Gold (C)	M39012/05-0101	A/07
2, 3	3	1.39	1.66	.750	Nickel	Gold	1105004N000-000	A/04
5	3	1.39	2.00	.750	Nickel	Gold (C)	1104032N001-000	A/08
5, 6	2	1.55	1.28	.500	Nickel	Silver (C)	1105015N000-000	A/11
5, 6	3	1.35	1.55	.560	Nickel	Silver (C)	1105015N001-000	A/09
7	2	1.55	1.28	.500	Nickel	Silver (C)	1105021N000-000	A/11
9	2	1.55	1.28	.500	Nickel	Silver (C)	1105036N001-000	A/11
19	3	1.36	1.66	.750	Nickel	Silver (C)	1104027N001-000	A/07

## Right Angle Plug - Crimp For Flexible Cable

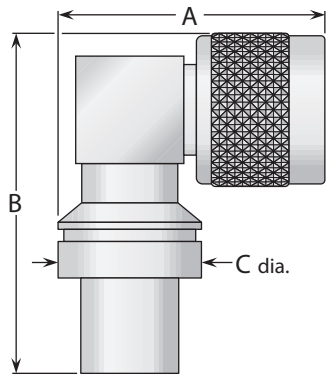


Figure 1  
(Cube body)

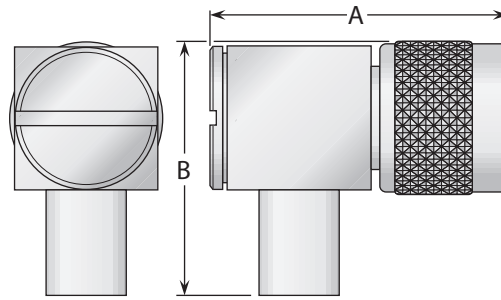


Figure 2  
(Cube body with access cap)

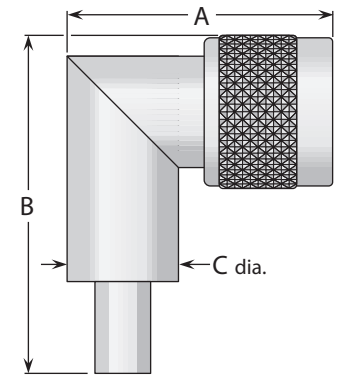


Figure 3  
(Mitered body)

Cable Group	Figure	Dimensions			Plating		Delta P/N	Assembly Procedure/ Trim Code
		A	B	C	Body	Contact		
2	1	1.39	1.77	.750	Nickel	Silver	1107002N000-000	B/07
2	2	1.39	1.25	—	Nickel	Silver (C)	1107002N000-001	B/09
3	1	1.39	1.77	.750	Nickel	Silver	1107005N000-000	B/07
2	3	1.41	2.30	.687	Nickel	Gold (C)	1107002N001-002	B/30
3	3	1.41	2.30	.687	Nickel	Gold (C)	1107004N001-002	B/30
6	3	1.41	2.25	.687	Nickel	Gold (C)	1107034N001-001	B/08

- See page 209 for cable groups.
- Assembly procedures start on page 210.
- (C) in contact plating column indicates captive contact.
- See page 6 for alternate body plating information.

## Tee Plug - For Flexible & Semi-Rigid Cable

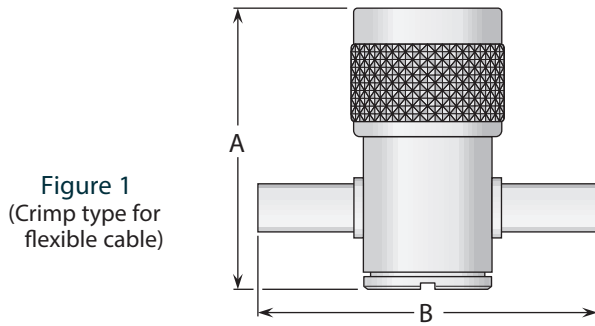


Figure 1  
(Crimp type for flexible cable)

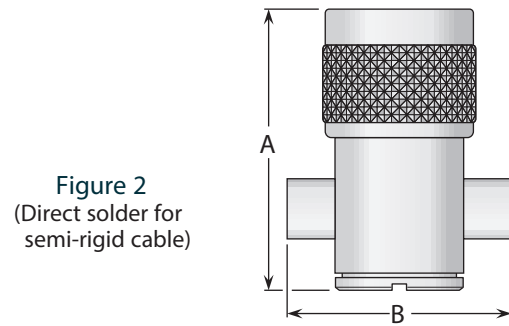


Figure 2  
(Direct solder for semi-rigid cable)

Cable Group	Figure	Dimensions		Plating		Delta P/N	Assembly Procedure/ Trim Code
		A	B	Body	Contact		
2	1	1.39	2.00	Silver	Silver (C)	1185002A000-000	B/16
3	1	1.39	2.00	Silver	Silver (C)	1185004A000-002	B/16
6	1	1.39	1.82	Silver	Silver (C)	1185013A001-000	B/17
7	1	1.39	1.82	Silver	Silver (C)	1185019A000-000	B/17
9	1	1.39	1.82	Silver	Silver (C)	1185036A000-000	B/17
13	2	1.39	.900	Silver	Silver (C)	1185031A000-000	***

## Straight Jack - Military Clamp For Flexible Cable

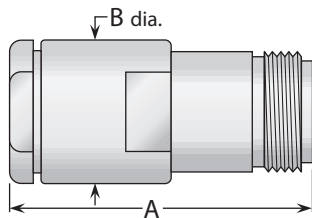


Figure 1

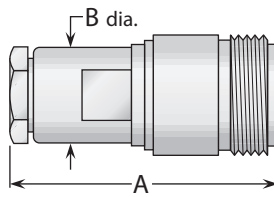


Figure 2

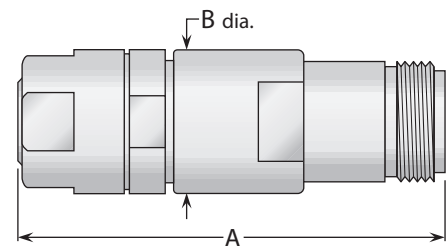


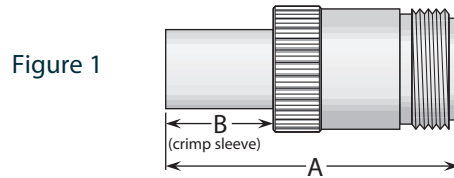
Figure 3  
(Includes armor clamp)

Cable Group	Figure	Dimensions		Plating		Delta P/N	Assembly Procedure/ Trim Code
		A	B	Body	Contact		
1	1	1.56	.750	Nickel	Silver	UG-20E/U	A/01
1	1	1.67	.750	Silver	Gold (C)	M39012/02-0101	A/01
2, 3	1	1.56	.750	Nickel	Silver	UG-23D/U	A/01
2, 3	1	1.56	.750	Nickel	Gold	UG-23F/U	A/01
2, 3	1	1.56	.750	Nickel	Silver (C)	UG-1186/U	A/01
2, 3	1	1.56	.750	Nickel	Silver (C)	UG-1186A/U	A/01
2, 3	1	1.67	.750	Silver	Gold (C)	M39012/02-0003	A/01
5, 6	2	1.41	.500	Nickel	Silver	1108015N000-000	A/05
5, 6	2	1.47	.500	Nickel	Silver (C)	1108015N001-000	A/02
7	2	1.41	.500	Nickel	Silver	UG-602A/U	A/02
7	2	1.27	.500	Nickel	Silver	1108000N000-003 *	—
7	2	1.47	.500	Nickel	Silver (C)	1108021N001-000	A/02
15	3	2.25	.750	Nickel	Silver	UG-940B/U	D/03
19	1	1.56	.750	Nickel	Gold (C)	1108027N001-000	A/12
22	1	1.87	.690	Nickel	Gold	1108123N000-000	C/03

\*UG-602A/U less clamping hardware.

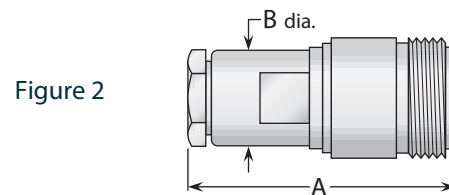
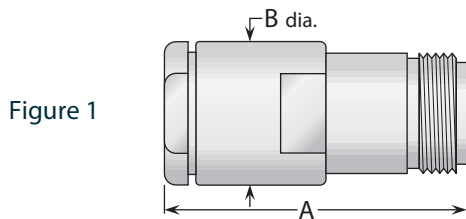
- See page 209 for cable groups.
- Assembly procedures start on page 210.
- \*\*\*Contact factory for cable assembly instructions.
- (C) in contact plating column indicates captive contact.
- See page 6 for alternate body plating information.

## Straight Jack - Crimp Type For Flexible Cable



Cable Group	Figure	Dimensions		Plating		Delta P/N	Assembly Procedure/ Trim Code
		A	B	Body	Contact		
2	1	1.64	.600	Silver	Gold (C)	M39012/02B0008	B/10
2	1	1.64	.600	Silver	Gold (C)	M39012/02-0502	B/03
2	1	1.47	.500	Nickel	Gold	1110002N000-000	B/10
2	1	1.60	.630	Nickel	Gold (C)	1110002N001-000	B/11
3	1	1.64	.600	Silver	Gold (C)	M39012/02B0009	B/10
3	1	1.64	.600	Silver	Gold (C)	M39012/02-0501	B/03
3	1	1.47	.500	Nickel	Gold	1110005N000-000	B/10
3	1	1.60	.630	Nickel	Gold (C)	1110005N001-000	B/10
6	1	1.56	.500	Nickel	Gold	1110013N000-001	B/12
6	1	1.54	.500	Silver	Gold (C)	M39012/02-0503	B/03

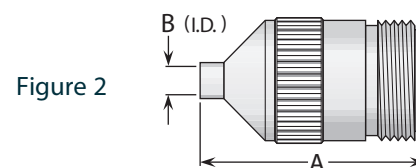
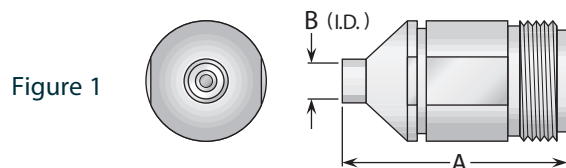
## Straight Jack - Heli-Grip® For Flexible Cable



Cable Group	Figure	Dimensions		Plating		Delta P/N	Assembly Procedure/ Trim Code
		A	B	Body	Contact		
2, 3	1	1.63	.750	Nickel	Gold (C)	1108004N005-002	E/01
5, 6 <sup>§</sup>	2	1.41	.500	Nickel	Gold (C)	1108018N005-002	E/02
RG-223	2	1.41	.500	Nickel	Gold (C)	1108015N005-000	E/02
7	2	1.41	.500	Nickel	Gold (C)	1108019N005-002	E/02
8	2	1.41	.500	Nickel	Gold (C)	1108029N005-001	E/02
9	2	1.41	.500	Nickel	Gold (C)	1108037N005-002	E/02

<sup>§</sup>Except RG-223/U.

## Straight Jack - For Semi-Rigid Cable



Cable Group	Figure	Dimensions		Plating		Delta P/N	Assembly Procedure/ Trim Code
		A	B	Body	Contact		
12	1	1.07	.254	Silver	Gold	1108050A003-003	***
13	2	1.00	.143	Silver	Gold	1108031A003-000	***

- See page 209 for cable groups.
- Assembly procedures start on page 210.
- \*\*\*Contact factory for cable assembly instructions.
- (C) in contact plating column indicates captive contact.
- See page 6 for alternate body plating information.

## Bulkhead Jack - Military Clamp For Flexible Cable

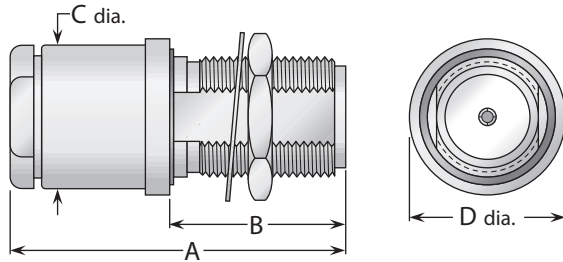


Figure 1  
(Rear mount)

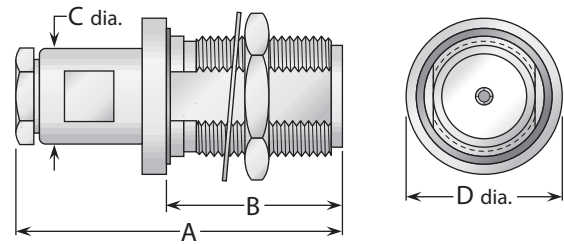
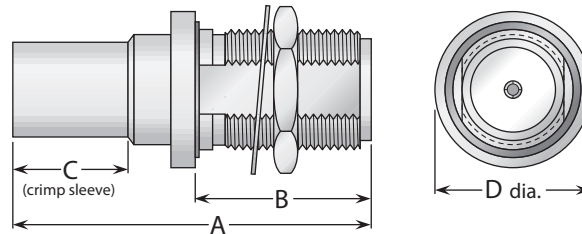


Figure 2  
(Rear mount)

Cable Group	Fig.	Dimensions				Mounting Figure	Max. Panel	Plating		Delta P/N	Assembly Procedure/Trim Code
		A	B	C	D			Body	Contact		
1	1	1.75	.920	.750	.900	72	.250	Silver	Gold (C)	M39012/03-0101	A/01
2, 3	1	1.75	.920	.750	.875	72	.250	Nickel	Silver	UG-160D/U	A/01
2, 3	1	1.84	.920	.750	.812	72	.250	Nickel	Silver (C)	1116003N721-000	***
2, 3	1	1.75	.920	.750	.875	72	.250	Nickel	Gold	1116004N720-001	A/01
5, 6	2	1.67	.920	.500	.812	72	.250	Nickel	Silver	UG-556B/U	A/06
5, 6	2	1.67	.920	.500	.875	72	.250	Nickel	Gold (C)	1116015N721-000	A/02
7	2	1.47	.920	.500	.875	72	.250	Nickel	Silver	1116021N720-000	A/14
7	2	1.47	.920	.500	.875	72	.250	Nickel	Gold (C)	1116021N721-000	A/14
9	2	1.48	.920	.500	.875	72	.250	Nickel	Silver (C)	1116036N721-000	A/10
10	2	1.48	.920	.500	.875	72	.250	Nickel	Silver (C)	1116100N721-000	A/10
11	2	1.48	.920	.500	.875	72	.250	Nickel	Silver (C)	1116038N721-000	A/10
16	1	1.90	.920	.880	.875	72	.250	Silver	Gold (C)	M39012/03-0102	A/01

## Bulkhead Jack - Crimp Type For Flexible Cable

Figure 1  
(Rear mount)



Cable Group	Fig.	Dimensions				Mounting Figure	Max. Panel	Plating		Delta P/N	Assembly Procedure/Trim Code
		A	B	C	D			Body	Contact		
2	1	1.84	.920	.600	.875	72	.250	Silver	Gold (C)	M39012/03B0004	B/03
2	1	1.84	.920	.600	.875	72	.250	Silver	Gold (C)	M39012/03-0502	B/03
3	1	1.84	.920	.600	.875	72	.250	Silver	Gold (C)	M39012/03B0005	B/03
3	1	1.84	.920	.600	.875	72	.250	Silver	Gold (C)	M39012/03-0501	B/03
6	1	1.74	.950	.500	.875	72	.250	Nickel	Gold (C)	1119013N721-000	B/13
6	1	1.74	.920	.500	.875	72	.250	Silver	Gold (C)	M39012/03-0503	B/03
7	1	1.59	.920	.500	.812	72	.250	Nickel	Silver	1119020N720-000	B/14
9	1	1.45	.880	.440	.812	72	.250	Nickel	Silver (C)	1119036N721-000	B/15
10	1	1.45	.880	.440	.812	72	.250	Nickel	Gold (C)	1119100N721-000	B/15

- See page 209 for cable groups. • Assembly procedures start on page 210. • \*\*\*Contact factory for cable assembly instructions
- See page 208 for mounting dimensions. • (C) in contact plating column indicates captive contact.
- See page 6 for alternate body plating information.



## Bulkhead Jack - Heli-Grip® For Flexible Cable

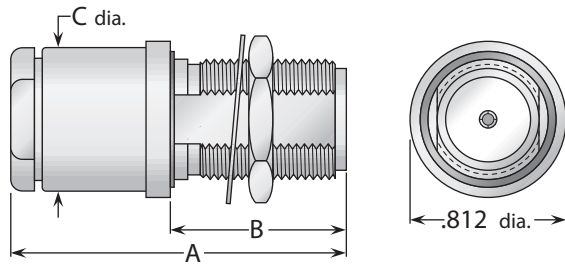


Figure 1

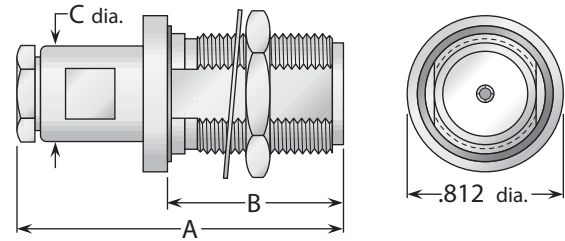
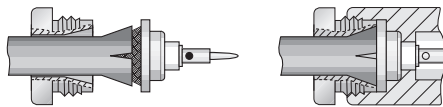


Figure 2

### Heli-Grip® Cable Attachment



These connectors have captivated contacts and allow rapid, easy assembly—simply trim the cable, slide into the cone/insulator/contact assembly (left), solder the center conductor to the contact, and screw body assembly (right) onto cable assembly.

Cable Group	Fig.	Dimensions			Mounting Figure	Max. Panel	Plating		Delta P/N	Assembly Procedure/Trim Code
		A	B	C			Body	Contact		
2, 3	1	1.84	.920	.750	72	.250	Nickel	Gold (C)	1116004N725-000	E/01
5, 6 <sup>§</sup>	2	1.69	.920	.500	72	.250	Nickel	Gold (C)	1116015N725-000	E/03
RG-223	2	1.69	.920	.500	72	.250	Nickel	Gold (C)	1116015N725-001	E/03
7	2	1.69	.920	.500	72	.250	Nickel	Gold (C)	1116021N725-000	E/03
10	2	1.69	.920	.500	72	.250	Nickel	Gold (C)	1116100N725-000	E/03

<sup>§</sup>Except RG-223/U.

## Tee Bulkhead Jack - For Flexible & Semi-Rigid Cable

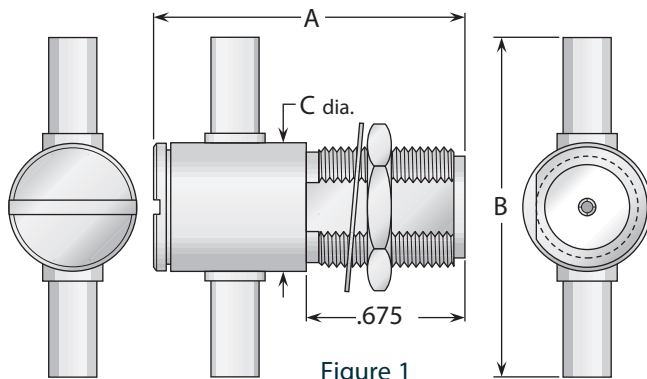


Figure 1  
(Crimp type for flexible cable)

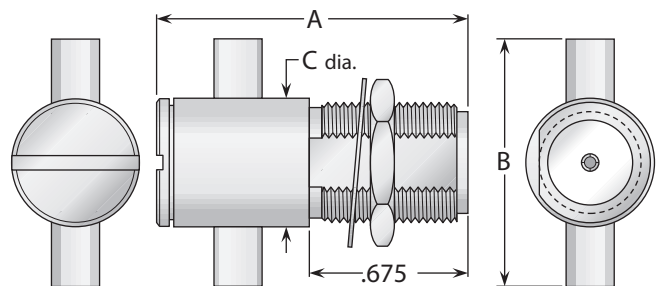
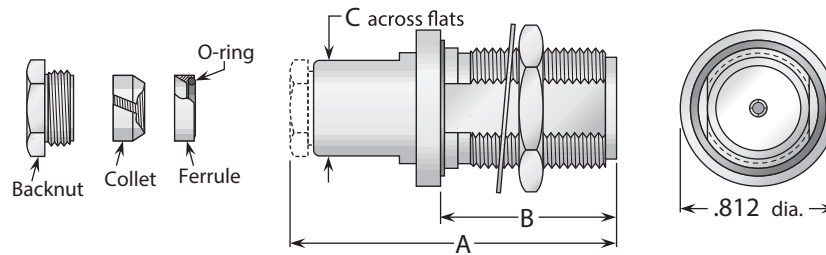


Figure 2  
(Direct solder for semi-rigid cable)

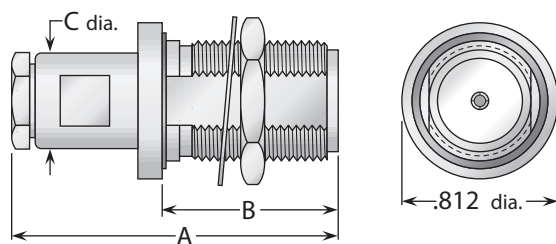
Cable Group	Fig.	Dimensions			Mounting Figure	Max. Panel	Plating		Delta P/N	Assembly Procedure/Trim Code
		A	B	C			Body	Contact		
2	1	1.40	2.00	.750	55	.100	Silver	Silver (C)	1185002A551-000	B/16
3	1	1.40	2.00	.750	55	.100	Silver	Silver (C)	1185004A551-000	B/16
6	1	1.38	1.89	.750	55	.100	Silver	Silver (C)	1185013A551-000	B/17
7	1	1.38	1.89	.750	55	.100	Silver	Silver (C)	1185019A551-000	B/17
9	1	1.38	1.89	.750	55	.100	Silver	Silver (C)	1185036A551-000	B/17
13	2	1.38	.900	.750	55	.100	Silver	Silver (C)	1185031A551-000	***

- See page 209 for cable groups.
- Assembly procedures start on page 210.
- \*\*\* Contact factory for cable assembly instructions.
- See page 208 for mounting dimensions.
- (C) in contact plating column indicates captive contact.
- See page 6 for alternate body plating information.

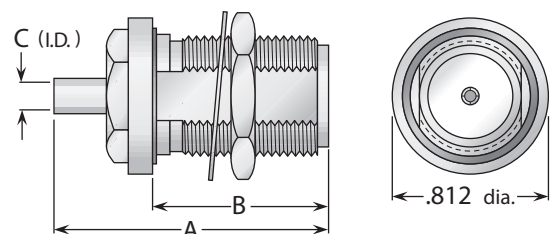
## Bulkhead Jack - For Semi-Rigid Cable



**Figure 1**  
(Collet clamp [solderless] cable attachment, captive contact in body)



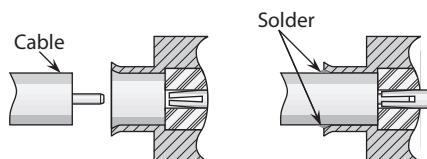
**Figure 2**  
(Solder-clamp; gold-plated ferrule, nickel-plated body)



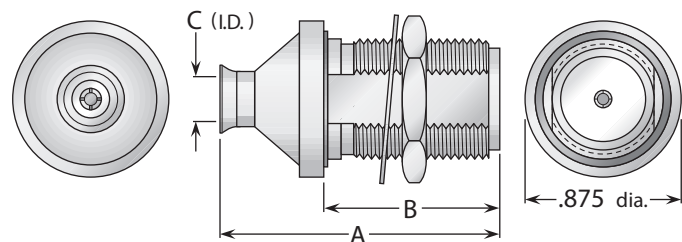
**Figure 3**  
(Direct solder)

## Delta One-Step Cable Attachment - For Semi-Rigid Cable

### One-Step Cable Attachment



Delta "One-Step" connectors feature captivated contacts and insulators to allow rapid, easy assembly to semi-rigid cable—simply trim the cable jacket and dielectric flush, chamfer the center conductor, insert into the connector, and solder the jacket to the connector body.



**Figure 4**  
(One-Step cable attachment)

Cable Group	Fig.	Dimensions			Mounting Figure	Max. Panel	Plating		Delta P/N	Assembly Procedure/Trim Code
		A	B	C			Body	Contact		
12	1	1.55	.889	.500	72	.250	Nickel	Gold (C)	1116163N721-000	***
13	2	1.67	.922	.500	72	.250	Nickel	Gold	1116031N720-000	F/04
13	3	1.33	.884	.145	72	.250	Nickel	Gold	1116031N723-001	***
13	4	1.38	.922	.143	72	.250	Silver	Gold (C)	1116031A723-003	I/01
14	2	1.67	.922	.500	72	.250	Nickel	Gold	1116025N723-000	F/04
14	3	1.33	.884	.090	72	.250	Nickel	Gold	1116025N723-001	***
14	4	1.38	.922	.088	72	.250	Silver	Gold (C)	1116025A723-002	I/01

- See page 209 for cable groups.
- Assembly procedures start on page 210.
- \*\*\* Contact factory for cable assembly instructions.
- See page 208 for mounting dimensions.
- (C) in contact plating column indicates captive contact.
- See page 6 for alternate body plating information.

## Panel Jack - For Flexible Cable

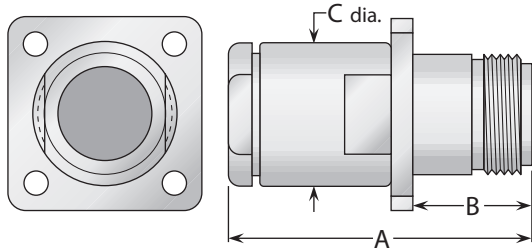


Figure 1

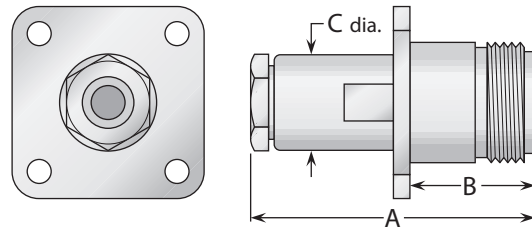
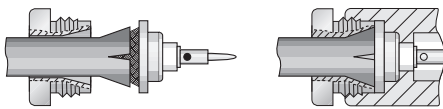


Figure 2

### Heli-Grip® Cable Attachment (where noted)



These connectors have captivated contacts and allow rapid, easy assembly—simply trim the cable, slide into the cone/insulator/contact assembly (left), solder the center conductor to the contact, and screw body assembly (right) onto cable assembly.

## Military Clamp For Flexible Cable

Cable Group	Fig.	Dimensions			Mounting Figure	Plating		Delta P/N	Assembly Procedure/Trim Code
		A	B	C		Body	Contact		
1	1	1.67	.660	.750	33	Silver	Gold (C)	M39012/02-0104	A/01
2, 3	1	1.58	.660	.750	33	Nickel	Silver	UG-22D/U	A/01
2, 3	1	1.58	.660	.750	33	Nickel	Gold	UG-22F/U	A/01
2, 3	1	1.58	.660	.750	33	Nickel	Silver (C)	UG-1187/U	A/01
2, 3	1	1.58	.660	.750	33	Nickel	Silver (C)	UG-1187A/U	A/01
2, 3	1	1.67	.660	.750	33	Silver	Gold (C)	M39012/02-0006	A/01
5, 6	2	1.41	.660	.500	33	Nickel	Silver	UG-1095B/U	A/13
5, 6	2	1.41	.660	.500	33	Nickel	Gold	UG-1095C/U	A/13
5, 6	2	1.41	.660	.500	27	Nickel	Silver	1111015N270-000	A/13
5, 6	2	1.48	.660	.500	27	Nickel	Gold (C)	1111015N271-000	A/02
5, 6	2	1.41	.660	.500	33	Nickel	Silver (C)	1111015N331-000	A/02
7	2	1.41	.660	.500	33	Nickel	Silver	UG-593A/U	A/14
9	2	1.44	.660	.500	33	Nickel	Silver	1111036N330-000	A/16
9	2	1.48	.660	.500	33	Nickel	Silver (C)	1111036N331-000	A/15
19	1	1.56	.660	.750	33	Nickel	Gold (C)	1111027N331-000	A/12
22	1	1.87	.660	.690	30	Nickel	Gold	1111123N300-000	C/03

## Heli-Grip For Flexible Cable

Cable Group	Fig.	Dimensions			Mounting Figure	Plating		Delta P/N	Assembly Procedure/Trim Code
		A	B	C		Body	Contact		
2, 3	1	1.58	.660	.750	33	Nickel	Gold (C)	1111004N335-000	E/01
5, 6 <sup>§</sup>	2	1.41	.660	.500	33	Nickel	Gold (C)	1111015N335-000	E/03
RG-223	2	1.41	.920	.500	33	Nickel	Gold (C)	1111015N335-001	E/03
7	2	1.41	.660	.500	33	Nickel	Gold (C)	1111021N335-000	E/03
9	2	1.41	.660	.500	33	Nickel	Gold (C)	1111037N335-001	E/03
10	2	1.41	.660	.500	33	Nickel	Gold (C)	1111100N335-001	E/03

<sup>§</sup>Except RG-223/U.

- See page 209 for cable groups.
- Assembly procedures start on page 210.
- See page 208 for mounting dimensions.
- (C) in contact plating column indicates captive contact.
- See page 6 for alternate body plating information.

## Panel Jack - Crimp Type For Flexible Cable

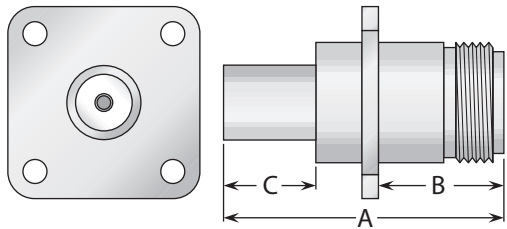


Figure 1 (Standard crimp type)

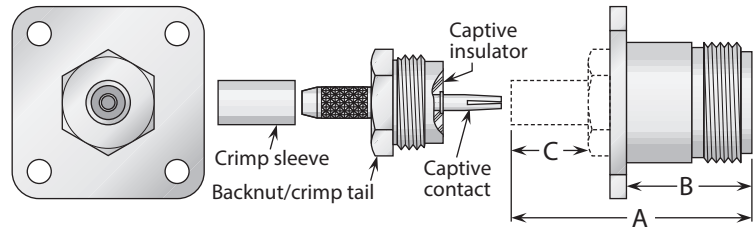


Figure 2 (Contact and insulator captive in backnut)

Cable Group	Fig.	Dimensions			Mounting Figure	Plating		Delta P/N	Assembly Procedure/Trim Code
		A	B	C		Body	Contact		
2	1	1.64	.660	.600	33	Silver	Gold (C)	M39012/02-0512	B/03
3	1	1.64	.660	.600	33	Silver	Gold (C)	M39012/02-0511	B/03
5	2	1.19	.595	.500	33	Nickel	Silver (C)	1155017N331-000	***
6	2	1.19	.595	.500	33	Nickel	Silver (C)	1155013N331-000	***
6	1	1.54	.660	.500	33	Silver	Gold (C)	M39012/02-0513	B/03
9	2	1.16	.595	.380	33	Nickel	Silver (C)	1155037N331-000	***

## Panel Jack - For Semi-Rigid Cable

Figure 1  
(Solder-clamp; gold-plated ferrule, nickel-plated body)

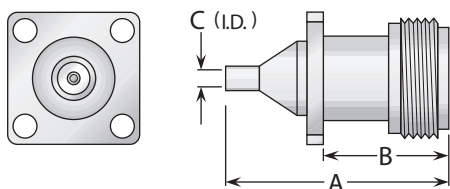
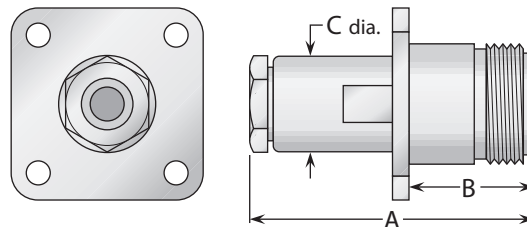


Figure 2 (One-Step cable attachment—see page 76 for details)

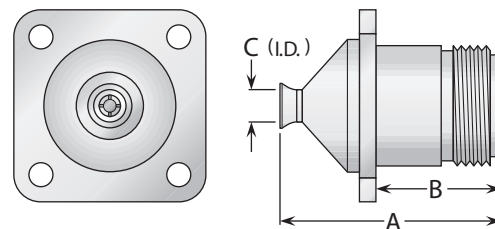


Figure 3 (One-Step cable attachment—see page 76 for details)

Cable Group	Fig.	Dimensions			Mounting Figure	Plating		Delta P/N	Assembly Procedure/Trim Code
		A	B	C		Body	Contact		
13	1	1.41	.660	.500	33	Nickel	Gold	1111031N333-001	F/05
13	2	1.11	.660	.143	09	Silver	Gold (C)	1111031A091-001	I/01
13	3	1.07	.640	.143	33	Silver	Gold (C)	1111031A333-004	I/01
14	1	1.41	.660	.500	33	Nickel	Gold	1111025N333-000	F/05
14	2	1.11	.660	.088	09	Silver	Gold (C)	1111025A091-001	I/01
14	3	1.07	.640	.088	33	Silver	Gold (C)	1111025A333-002	I/01

- See page 209 for cable groups. • Assembly procedures start on page 210.
- \*\*\* Contact factory for cable assembly instructions. • See page 208 for mounting dimensions.
- (C) in contact plating column indicates captive contact. • See page 6 for alternate body plating information.

## Panel Jack Receptacle - Solder Pot Contact

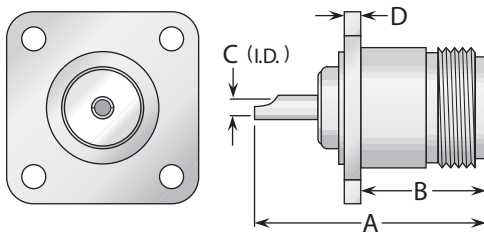


Figure 1

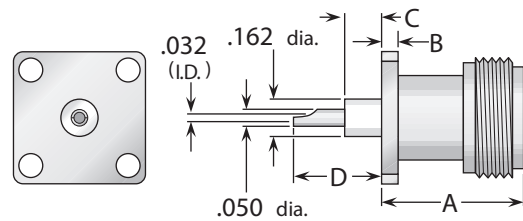


Figure 2  
(1<sup>1</sup>/<sub>16</sub>" square flange, interchangeable with BNC and TNC standard flange size)

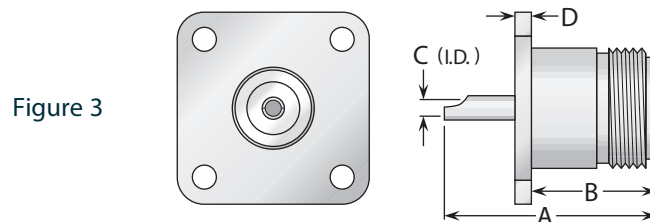


Figure 3

Figure	Dimensions				Mounting Figure	Plating		Delta P/N
	A	B	C	D		Body	Contact	
1	1.13	.660	.100	.080	33	Nickel	Silver (C)	UG-58A/U
1	1.13	.660	.100	.080	33	Silver	Gold (C)	M39012/04-0002
1	1.13	.660	.100	.050	18	Nickel	Silver (C)	1113000N181-000
1	1.13	.660	.100	.080	32A	Nickel	Silver (C)	1113000N321-002
1	1.13	.660	.100	.080	32	Nickel	Gold (C)	1113000N321-003
1	1.13	.660	.100	.080	33	Silver	Gold (C)	1113000A331-011
1	1.13	.660	.100	.080	33	Nickel	Gold (C)	1113000N331-011
1	1.13	.660	.100	.080	95	Nickel	Silver (C)	1113000N951-000
2	.735	.075	.125	.250	09	Nickel	Silver (C)	1113000N091-002
3	1.13	.660	.100	.080	33	Nickel	Gold (C)	1113000N331-009

## Panel Jack Receptacle - Solder Pot Contact

Round Flange (For Solder Or Setscrew Mounting)

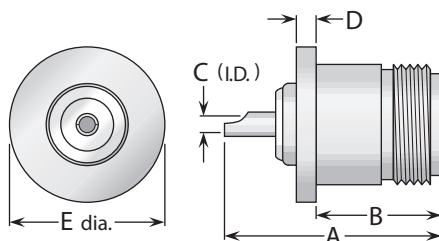


Figure 1

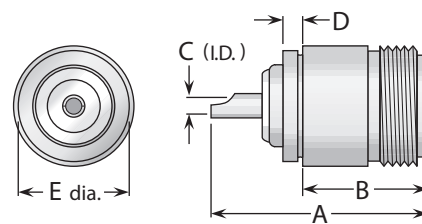
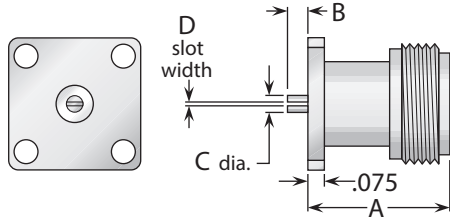


Figure 2

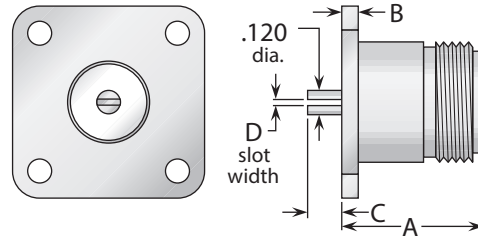
Figure	Dimensions					Plating		Delta P/N
	A	B	C	D	E	Body	Contact	
1	1.25	.660	.100	.175	1.50	Nickel	Silver (C)	1113000N911-002
1	1.25	.660	.100	.125	1.25	Nickel	Gold (C)	1113000N911-005
2	1.13	.660	.100	.110	.575	Nickel	Silver (C)	1120000N831-000

- (C) in contact plating column indicates captive contact.
- See page 208 for mounting dimensions.
- See page 6 for alternate body plating information.
- All items are available with other flange sizes and contact configurations.

## Panel Jack Receptacle - Slotted Contact



**Figure 1**  
(11/16" square flange, interchangeable with BNC and TNC standard flange size)

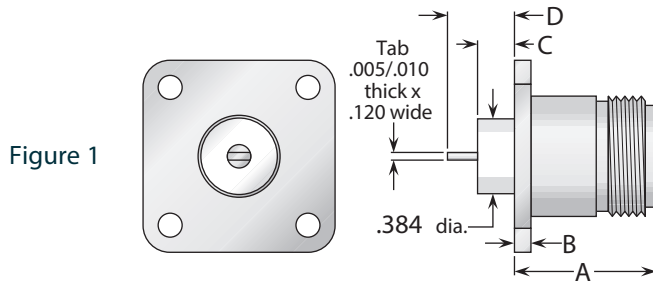


**Figure 2**

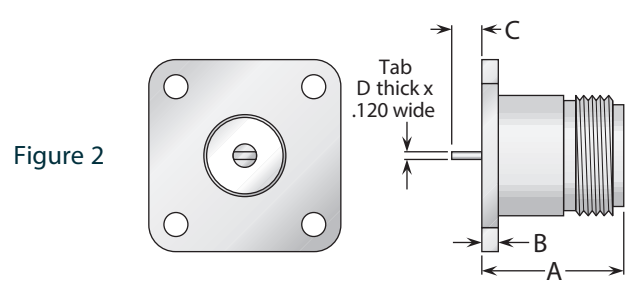
Figure	Dimensions				Mounting Figure	Plating		Delta P/N
	A	B	C	D		Body	Contact	
1	.735	.050	.086	.012/.017	09	Nickel	Gold (C)*	1143000N091-002
1	.735	.050	.086	.036	09	Nickel	Gold (C)*	1143000N091-003
1	.735	.050	.086	.007/.012	09	Nickel	Gold (C)*	1143000N091-004
1	.735	.050	.050	.012/.017	09	Nickel	Gold (C)*	1143000N091-009
2	.736	.080	.050	.012/.017	33	Nickel	Gold (C)*	1143000N330-010
2	.736	.080	.050	.026/.030	33	Nickel	Gold (C)*	1143000N331-017
2	.736	.080	.050	.020/.025	33	Nickel	Gold (C)	1143000N331-023
2	.735	.080	.050	.026/.030	33	Nickel	Gold (C)	1143000N331-054
2	.736	.080	.050	.012/.017	33	Nickel	Gold (C)	1143000N331-055

\*Epoxy-captivated contact.

## Panel Jack Receptacle - Tab Contact



**Figure 1**



**Figure 2**

**Figure 3**  
(11/16" square flange, interchangeable with BNC and TNC standard flange size)

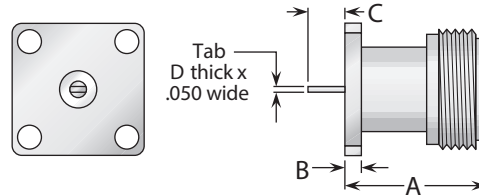


Figure	Dimensions				Mounting Figure	Plating		Delta P/N
	A	B	C	D		Body	Contact	
1	.736	.080	.195	.350	33	Nickel	Gold (C)*	1143000N330-012
2	.736	.080	.100	.005/.008	33	Silver	Gold (C)*	1158000A331-012
3	.735	.075	.050	.004/.006	09	Silver	Gold (C)*	1158000A091-023

\*Epoxy-captivated contact.

- (C) in contact plating column indicates captive contact.
- See page 208 for mounting dimensions.
- See page 6 for alternate body plating information.
- All items are available with other flange sizes and contact configurations.

## Panel Jack Receptacle - Post Contact

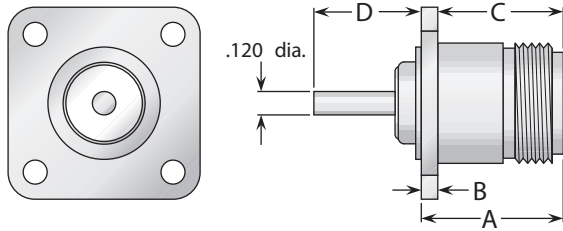


Figure 1

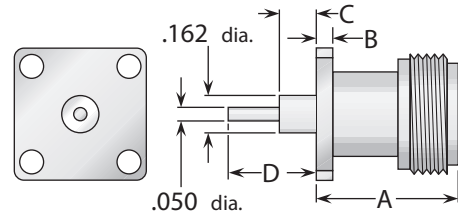


Figure 2

(<sup>11</sup>/<sub>16</sub>" square flange, interchangeable with BNC and TNC standard flange size)

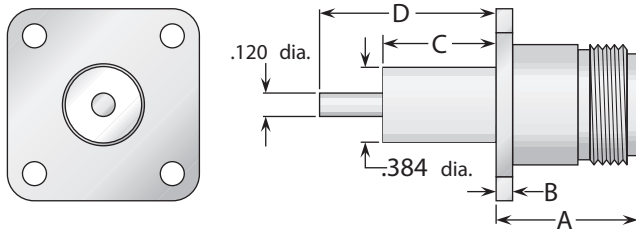


Figure 3

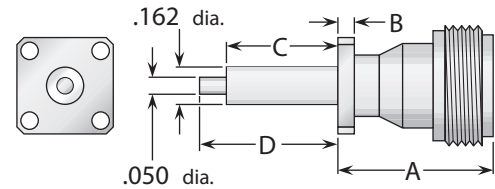


Figure 4

(<sup>1</sup>/<sub>2</sub>" square flange, interchangeable with SMA standard flange size)

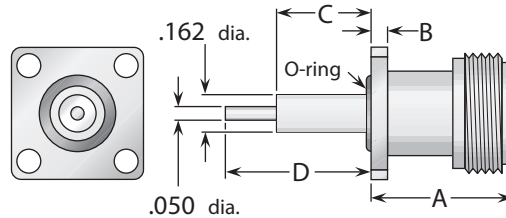


Figure 5

(O-ring seal on flange, <sup>11</sup>/<sub>16</sub>" square flange, interchangeable with BNC and TNC standard flange size)

Figure	Dimensions				Mounting Figure	Plating		Delta P/N
	A	B	C	D		Body	Contact	
1	.736	.080	.660	.560	33	Nickel	Gold (C)	1113000N331-028
2	.735	.075	.125	.250	09	Nickel	Silver (C)	1143000N091-018
2	.735	.075	.125	.250	09	Nickel	Gold (C)	1143000N091-030
2	.735	.075	.590	.705	09	Nickel	Gold (C)*	1143000N091-069
3	.736	.080	.590	.705	33	Nickel	Gold	1143000N330-018
3	.736	.080	.590	.705	33	Nickel	Gold (C)*	1158000N331-015
4	.814	.080	.590	.705	05	Nickel	Gold (C)	1143000N051-002
5	.735	.075	.200	.450	09	Nickel	Gold (C)	1143000N091-059
5	.735	.075	.750	.875	09	Nickel	Gold (C)	1143000N091-073
5	.735	.075	.375	.425	09	Nickel	Gold (C)*	1143000N091-075

\*Epoxy-captivated contact.

- (C) in contact plating column indicates captive contact.
- See page 208 for mounting dimensions.
- See page 6 for alternate body plating information.
- All items are available with other flange sizes and contact configurations.

## Right Angle Panel Jack Receptacle

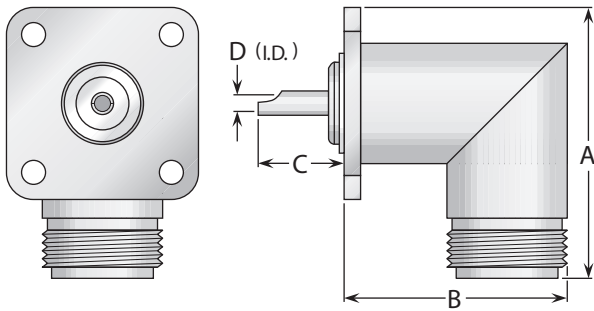


Figure 1

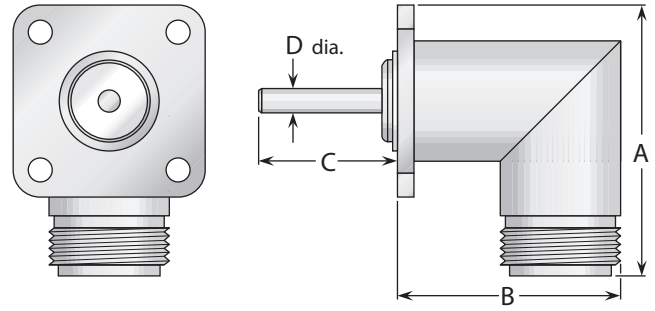


Figure 2

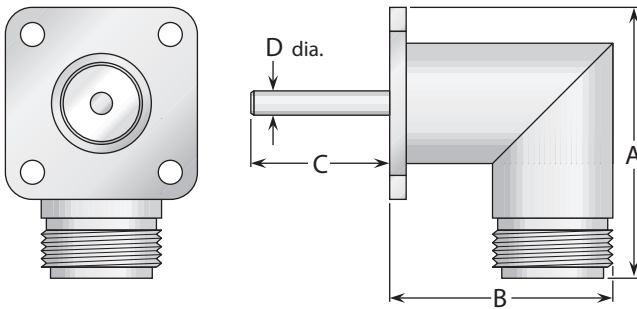


Figure 3

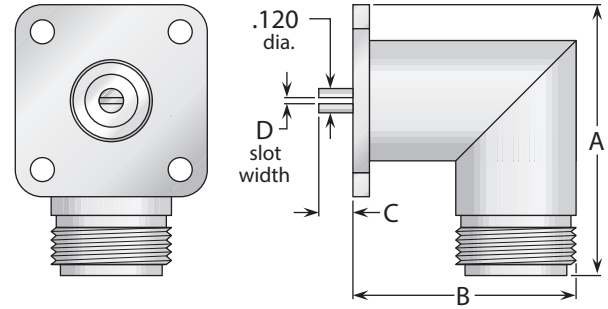
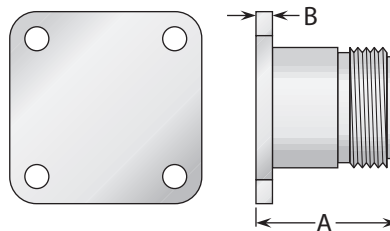


Figure 4

Figure	Dimensions				Mounting Figure	Plating		Delta P/N
	A	B	C	D		Body	Contact	
1	1.41	1.16	.300	.101	33	Nickel	Silver (C)	UG-997A/U
1	1.41	1.16	.300	.101	33	Nickel	Gold (C)	1115000N330-005
2	1.41	1.16	.750	.120	33	Nickel	Silver (C)	1115000N330-009
3	1.41	.830	.560	.120	33	Nickel	Gold (C)	1115000N330-012
4	1.41	1.17	.050	.020/.025	33	Nickel	Silver (C)	1115000N330-011

## Dummy Receptacle



Dimensions		Mounting Figure	Plating		Delta P/N
A	B		Body	Contact	
.740	.080	33	Nickel	—	1163000N330-000

- (C) in contact plating column indicates captive contact.
- See page 208 for mounting dimensions.
- See page 6 for alternate body plating information.
- All items are available with other flange sizes and contact configurations.



## Panel Plug Receptacles

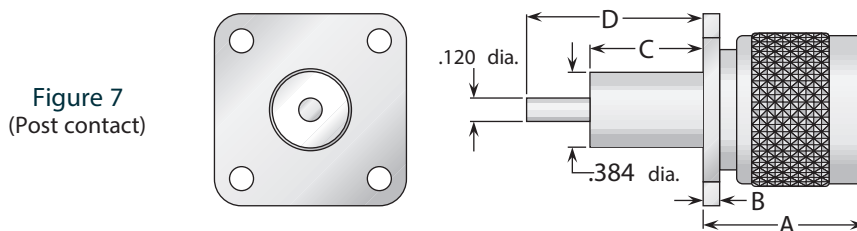
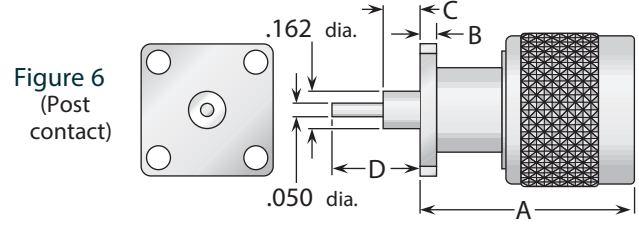
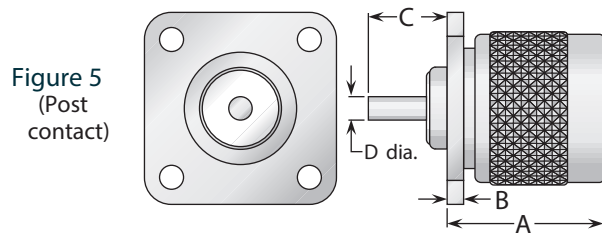
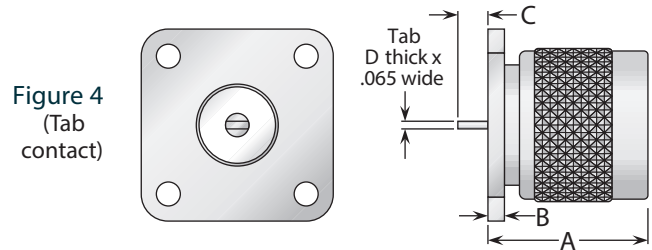
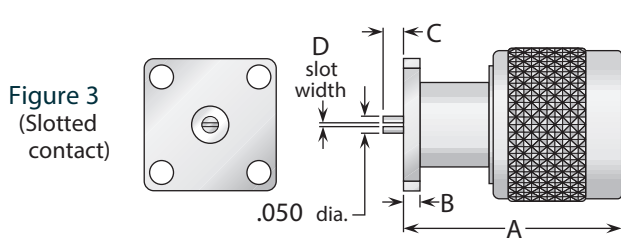
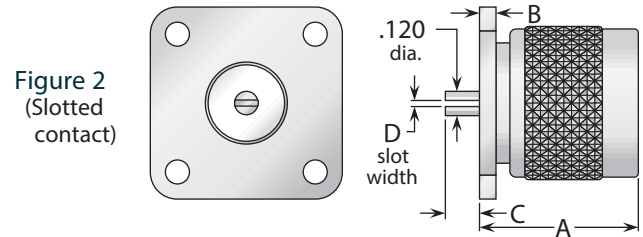
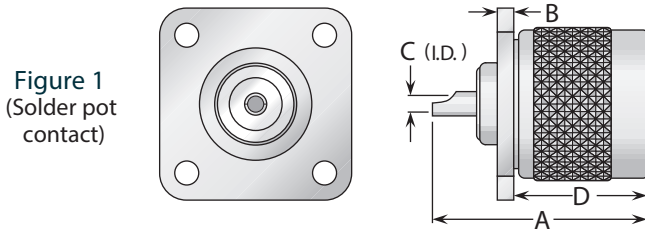
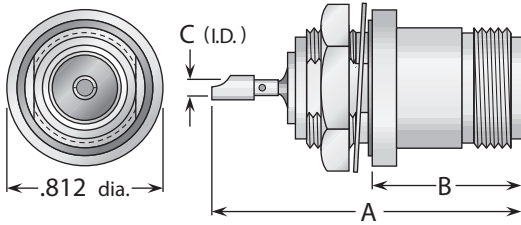


Figure	Dimensions				Mounting Figure	Plating		Delta P/N
	A	B	C	D		Body	Contact	
1	1.10	.080	.101	.720	33	Nickel	Silver (C)	1123000N330-000
1	1.10	.080	.101	.720	33	Nickel	Gold (C)	1123000N330-004
2	.780	.080	.050	.012/.017	33	Nickel	Gold (C)	1159000N330-001
2	.810	.080	.050	.012/.017	33	Nickel	Gold (C)	1159000N330-013
2	.810	.080	.050	.026/.030	33	Nickel	Gold (C)*	1159000N331-026
3	1.17	.075	.050	.020	09	Nickel	Gold (C)*	1159000N091-004
4	.810	.080	.100	.005/.008	33	Nickel	Gold (C)*	1159000N331-009
5	.810	.080	.360	.120	33	Nickel	Gold (C)	1123000N330-002
6	1.17	.075	.125	.250	09	Nickel	Gold (C)	1159000N091-010
7	.810	.080	.590	1.10	33	Nickel	Gold (C)*	1159000N331-006
7	.810	.080	.330	.488	33	Nickel	Gold	1159000N330-011
7	.810	.080	.330	.488	33	Nickel	Gold (C)*	1159000N331-000

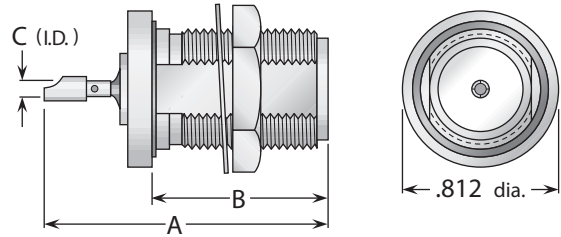
\*Epoxy-captivated contact.

- (C) in contact plating column indicates captive contact.
- See page 208 for mounting dimensions.
- See page 6 for alternate body plating information.
- All items are available with other flange sizes and contact configurations.

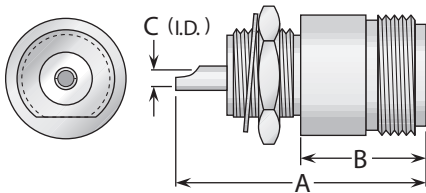
## Bulkhead Jack Receptacles



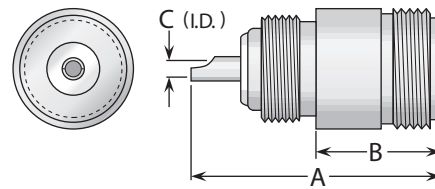
**Figure 1**  
(Front mount, hermetically sealed, with mounting gasket)



**Figure 2**  
(Rear mount, hermetically sealed, with mounting gasket)



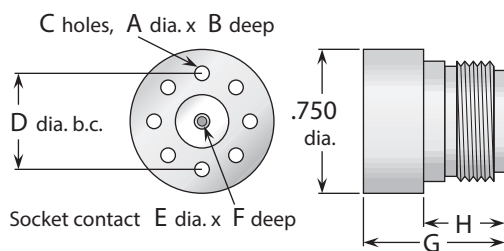
**Figure 3**  
(Front mount, no gasket)



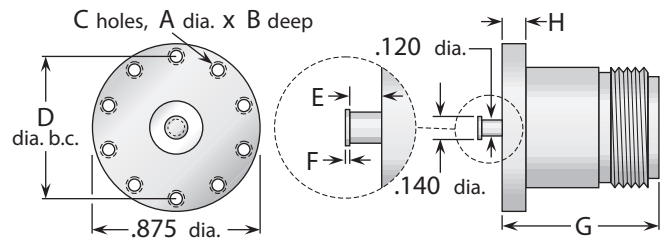
**Figure 4**  
(Front mount, no gasket, screw-in type for 9/16-24 tapped hole)

Figure	Dimensions			Max. Panel	Mounting Figure	Plating		Delta P/N
	A	B	C			Body	Contact	
1	1.62	.707	.099	.100	72	Nickel	Silver (C)	UG-680/U
1	1.62	.707	.099	.100	72	Nickel	Silver (C)	UG-680A/U
1	1.62	.707	.099	.100	72	Silver	Gold (C)	M39012/04-0001
2	1.53	.919	.099	.250	72	Nickel	Silver (C)	1121000N728-005
3	1.25	.606	.099	.100	59	Nickel	Silver (C)	1120000N590-000
3	1.25	.606	.099	.100	59	Nickel	Gold (C)	1120000N590-004
4	1.15	.562	.099	.100	**	Nickel	Silver (C)	1120000N591-000

## Stripline Receptacles



**Figure 1**



**Figure 2**

Figure	Dimensions								Plating		Delta P/N
	A	B	C	D	E	F	G	H	Body	Contact	
1	#2-56	.250	7	.560	#0-80	.125	.734	.422	Nickel	Silver	1156000N000-000
1	.078	.313	7	.500	.063	.156	.734	.656	Nickel	Silver	1156000N000-002
1	#2-56	.250	7	.560	#2-56	.125	.734	.422	Nickel	Silver	1156000N000-003
2	#2-56	.125	10	.734	.125	.010	.816	.125	Nickel	Silver	1157000N000-003

- (C) in contact plating column indicates captive contact.
- See page 6 for alternate body plating information.
- See page 208 for mounting dimensions.
- All items are available with other flange sizes and contact configurations.

## Press Mount Jack Receptacles

### Delta PressMount Receptacles

These connectors eliminate the need for complicated mounting hole patterns and mounting hardware. They are simply pressed into a single through hole, and the precisely-engineered knurled mounting section provides retention strength far greater than normal mating and unmating forces.

An integral shoulder provides a positive stop when mounting.

PressMounts can be used in packages as small as the outer diameter of the connector body.

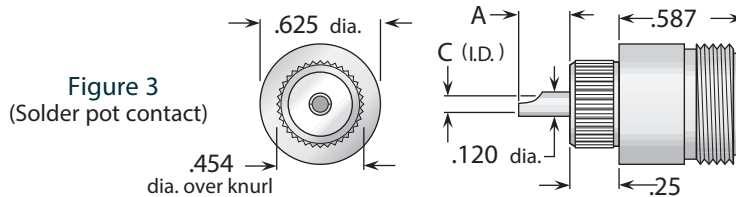
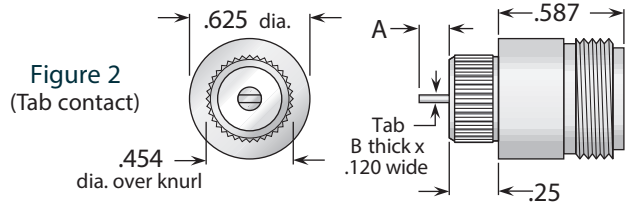
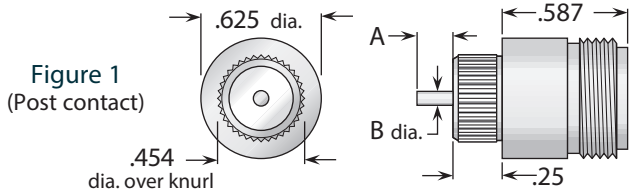
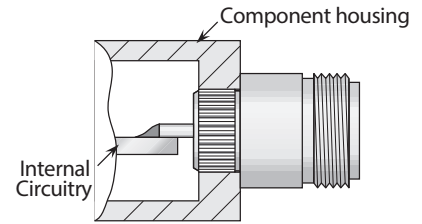


Figure	Dimensions		Min. Panel	Mounting Hole	Plating		Delta P/N
	A	B			Body	Contact	
1	.110	.050	.200	.450 ±.001 dia.	Nickel	Gold (C)	1120000N911-002
2	.100	.005/.008	.200	.450 ±.001 dia.	Nickel	Gold (C)	1120000N911-003
3	.285	.100	.200	.450 ±.001 dia.	Nickel	Gold (C)	1120000N911-004

## Press Mount Plug Receptacles

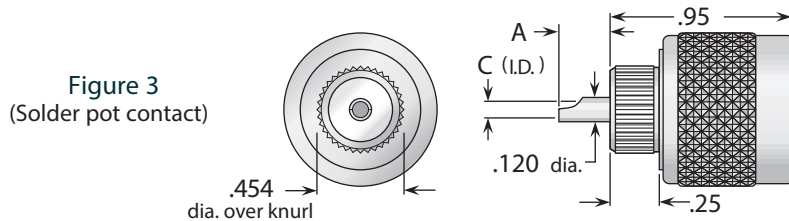
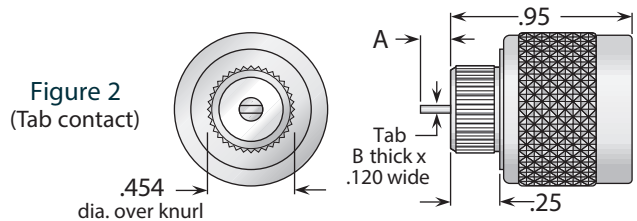
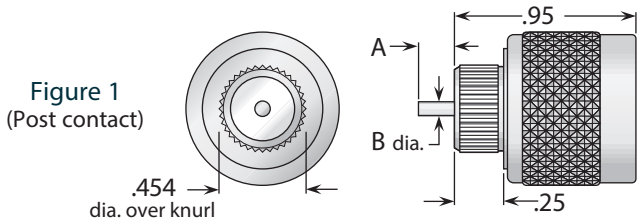
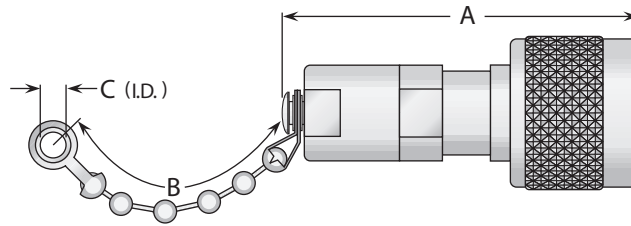


Figure	Dimensions		Min. Panel	Mounting Hole	Plating		Delta P/N
	A	B			Body	Contact	
1	.110	.050	.200	.450 ±.001 dia.	Nickel	Gold (C)	1124000N911-001
2	.100	.005/.008	.200	.450 ±.001 dia.	Nickel	Gold (C)	1124000N911-002
3	.250	.100	.200	.450 ±.001 dia.	Nickel	Gold (C)	1124000N911-000

- (C) in contact plating column indicates captive contact.
- See page 6 for alternate body plating information.
- All items are available with other flange sizes and contact configurations.

## Resistive Plug Termination



Resistor	Dimensions			Features	Plating		Delta P/N
	A	B	C		Body	Contact	
50Ω ±1%, 1Watt	1.78	—	—	No chain	Nickel	Silver (C)	1151000N000-003
50Ω ±1%, 1Watt	1.87	5.00	.144		Nickel	Gold (C)	1151000N000-010
51Ω ±5%, 1/2 Watt	1.61	3.50	.144		Nickel	Silver (C)	1131000N000-000
51Ω ±5%, 1/2 Watt	1.67	—	—	No chain	Nickel	Silver (C)	1131000N00A-000
51Ω ±5%, 1 Watt	1.87	3.75	.144		Nickel	Silver (C)	1151000N000-000
75Ω ±1%, 1 Watt	1.87	5.00	.144		Nickel	Gold (C)	1151000N000-011

## Dust Caps

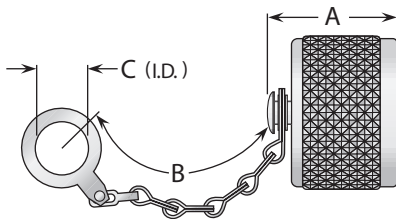


Figure 1  
(Shown with safety chain)

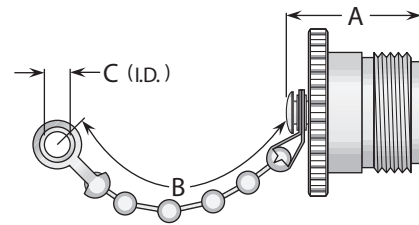
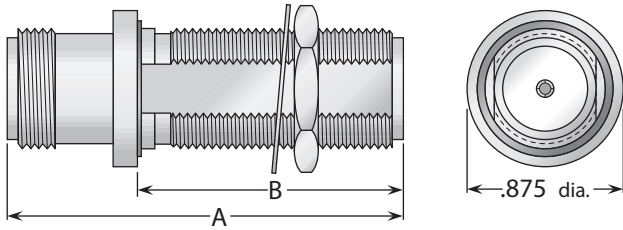


Figure 2  
(Shown with bead chain)

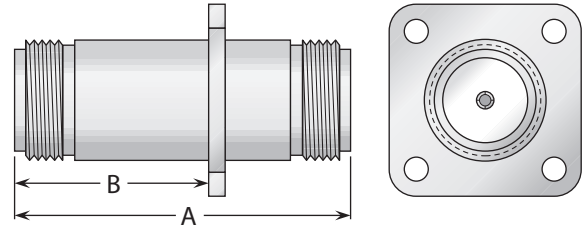
Figure	Dimensions			Features	Plating		Delta P/N
	A	B	C		Body	Contact	
1	.560	2.25	.144	Bead chain	Nickel	—	MX-913/U
1	.560	2.50	.144	Bead chain	Silver	—	M39012/25-0011
1	.560	3.75	.635	Safety chain	Silver	—	M39012/25-0012
1	.840	2.50	.170	Bead chain / shorting type	Nickel	Silver (C)	1132000N00C-002
2	.720	3.50	.144	Bead chain	Nickel	—	1133000N000-000
2	.910	2.50	.170	Bead chain / shorting type	Nickel	Silver (C)	1133000N00C-000

- (C) in contact plating column indicates captive contact.
- See page 6 for alternate body plating information.
- Caps and terminations are available with other chain styles and/or resistances.

## Bulkhead & Panel Mounted Jack - Jack Adapters (Connect Two Plugs)



**Figure 1**  
(Bulkhead mount, hermetically sealed)

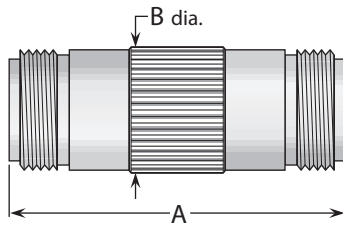


**Figure 2**  
(Panel mount)

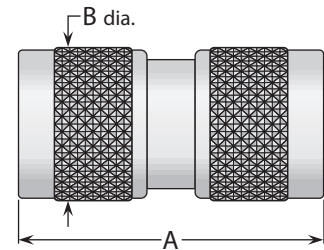
Figure	Dimensions		Max. Panel	Mounting Figure	Plating		Delta P/N
	A	B			Body	Contact	
1	1.54	.863	.250	72	Nickel	Silver (C)	UG-30D/U
1	1.54	.863	.250	72	Nickel	Silver (C)	UG-30E/U
1	1.54	.863	.250	72	Silver	Gold (C)	M55339/04-00030
1	2.06	1.375	.750	72	Nickel	Silver (C)	1126000N728-000
2	1.75	1.00	—	33	Nickel	Silver (C)	1125000N330-000

## Straight Adapters

**Figure 1**  
(Straight jack-jack;  
connects two plugs)



**Figure 2**  
(Straight plug-plug;  
connects two jacks)



**Figure 3**  
(Straight jack-plug;  
connects one plug  
and one jack)

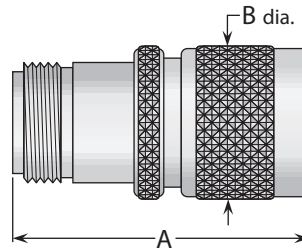
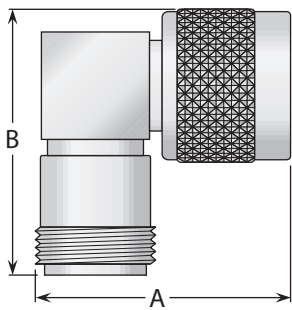


Figure	Dimensions		Plating		Delta P/N
	A	B	Body	Contact	
1	1.75	.660	Nickel	Silver (C)	UG-29B/U
1	1.75	.660	Silver	Gold (C)	M55339/07-00029
2	1.59	.780	Nickel	Silver (C)	UG-57B/U
2	1.59	.780	Silver	Gold (C)	M55339/05-00057 *
3	1.56	.780	Nickel	Silver (C)	1134000N000-000

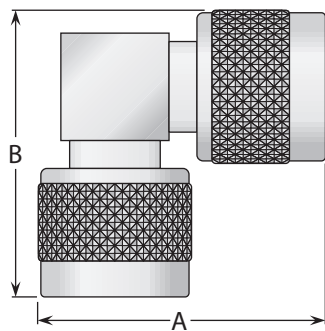
\* Lockwire holes in coupling nut.

(C) in contact plating column indicates captive contact. • See page 208 for mounting dimensions.  
See page 6 for alternate body plating information.

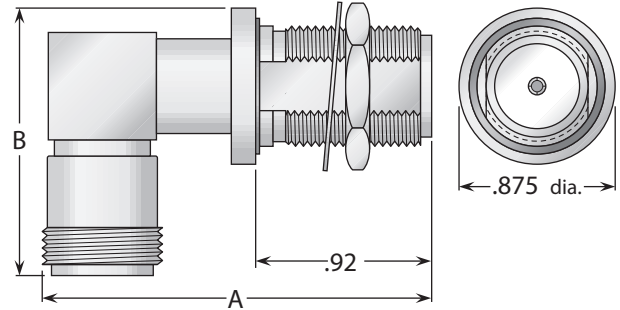
## Right Angle Adapters



**Figure 1**  
(Right angle plug-jack;  
connects one plug  
and one jack)



**Figure 2**  
(Right angle plug-plug;  
connects two jacks)

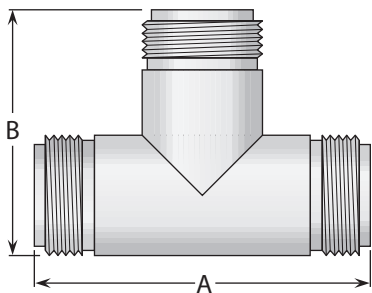


**Figure 3**  
(Bulkhead mounted right angle jack-jack;  
connects two plugs)

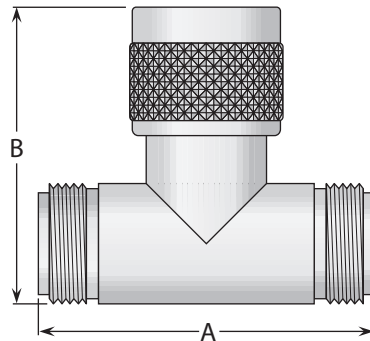
Figure	Dimensions		Max. Panel	Mounting Figure	Plating		Delta P/N
	A	B			Body	Contact	
1	1.30	1.38	—	—	Nickel	Silver (C)	UG-27C/U
1	1.30	1.38	—	—	Nickel	Gold (C)	UG-27D/U
1	1.30	1.38	—	—	Silver	Gold (C)	M55339/03-00027*
2	1.39	1.39	—	—	Nickel	Silver (C)	1137000N000-000
3	2.13	1.36	.250	72	Nickel	Gold (C)	UG-202A/U

\* Lockwire holes in coupling nut.

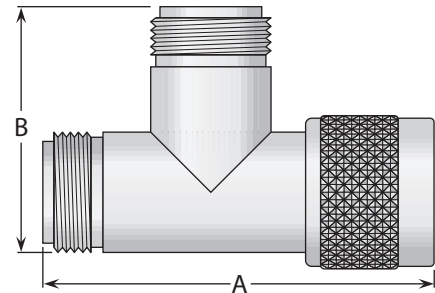
## Tee Adapters



**Figure 1**  
(Tee jack-jack-jack;  
connects three plugs)



**Figure 2**  
(Tee jack-plug-jack;  
connects two plugs and one jack)



**Figure 3**  
(Tee jack-jack-plug;  
connects two plugs and one jack)

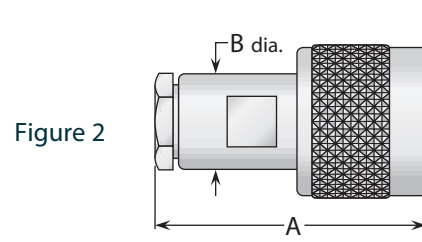
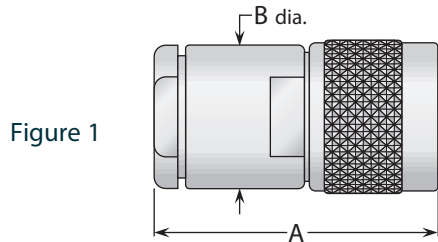
Figure	Dimensions		Plating		Delta P/N
	A	B	Body	Contact	
1	1.75	1.22	Nickel	Silver (C)	UG-28A/U
1	1.75	1.22	Silver	Gold (C)	M55339/06-00028
2	1.75	1.47	Nickel	Silver (C)	UG-107B/U
2	1.75	1.47	Silver	Gold (C)	M55339/06-00001
3	2.03	1.22	Nickel	Gold (C)	1149000N001-001

- (C) in contact plating column indicates captive contact.
- See page 208 for mounting dimensions.
- See page 6 for alternate body plating information.

## N70 Configurations

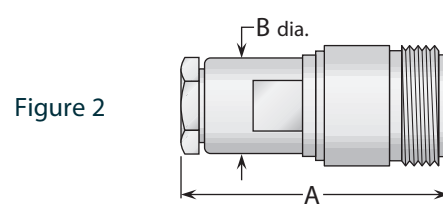
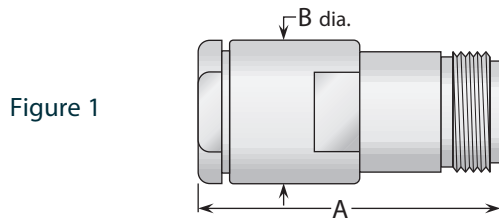
Straight Cable Plugs .....	89	Right Angle Panel Jack Receptacles .....	90
Straight Cable Jacks .....	89	Panel Plug Receptacles.....	90
Bulkhead Cable Jacks .....	89	Bulkhead Jack Receptacles .....	90
Panel Jack Receptacles (square flange) .....	90	In-Series Adapters .....	91

### Straight Plug - Military Clamp For Flexible Cable



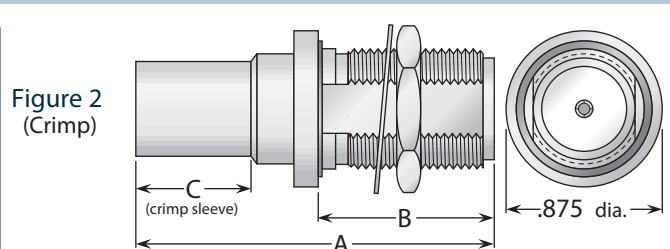
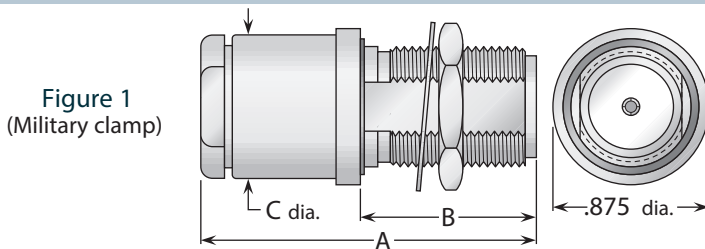
Cable Group	Figure	Dimensions		Plating		Delta P/N	Assembly Procedure/Trim Code
		A	B	Body	Contact		
2B, 3B	1	1.80	.690	Nickel	Silver	UG-94A/U	C/01
7	2	1.38	.500	Nickel	Silver	1801021N000-000	A/02

### Straight Jack - Military Clamp For Flexible Cable



Cable Group	Figure	Dimensions		Plating		Delta P/N	Assembly Procedure/Trim Code
		A	B	Body	Contact		
2B, 3B	1	1.88	.690	Nickel	Gold	UG-95A/U	C/08
7	2	1.41	.500	Nickel	Silver	1808021N000-000	A/02

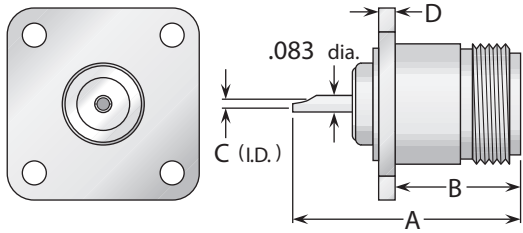
### Bulkhead Jacks - For Flexible Cable



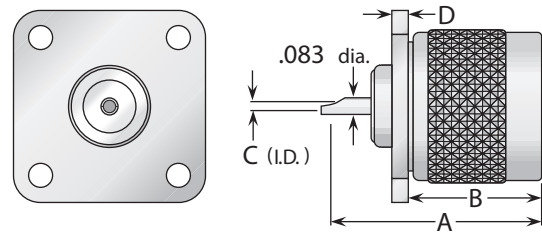
Cable Group	Fig.	Dimensions			Mounting Figure	Max. Panel	Plating		Delta P/N	Assembly Procedure/Trim Code
		A	B	C			Body	Contact		
2B, 3B	1	1.84	.920	.690	72	.250	Nickel	Gold	1816003N720-000	C/08
7	1	1.47	.920	.500	72	.250	Nickel	Silver (C)	1816021N721-000	A/14
2B, 3B	2	1.84	.920	.600	72	.250	Nickel	Gold	1819003N720-000	B/03
7	2	1.59	.920	.500	72	.250	Nickel	Silver	1819020N720-000	B/14

- See page 209 for cable groups.
- Assembly procedures start on page 210.
- See page 208 for mounting dimensions.
- (C) in contact plating column indicates captive contact.
- See page 6 for alternate body plating information.

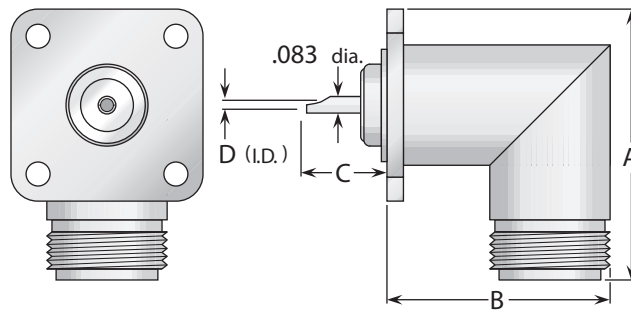
## Panel Receptacle - Solder Pot Contact



**Figure 1**  
(Straight jack receptacle)



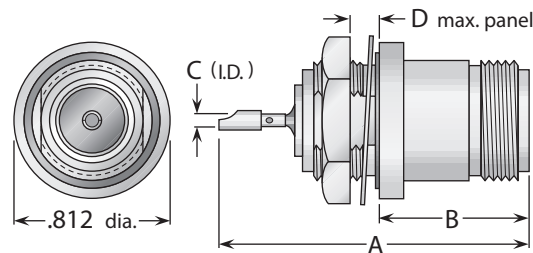
**Figure 2**  
(Straight plug receptacle)



**Figure 3**  
(Right angle jack receptacle)

Figure	Dimensions				Mounting Figure	Plating		Delta P/N
	A	B	C	D		Body	Contact	
1	1.13	.660	.062	.080	33	Nickel	Gold (C)	1813000N331-000
2	1.10	.720	.062	.080	33	Nickel	Silver (C)	1823000N331-001
3	1.41	1.16	.300	.050	33	Nickel	Gold (C)	1815000N330-000

## Bulkhead Receptacle - Solder Pot Contact



**Figure 1**  
(Front mount, hermetically sealed)

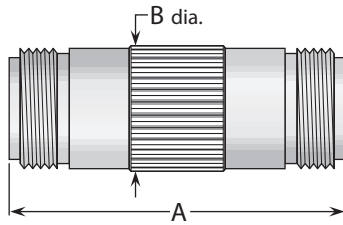
Figure	Dimensions				Mounting Figure	Plating		Delta P/N
	A	B	C	D		Body	Contact	
1	1.62	.707	.099	.250	72	Nickel	Silver (C)	1820000N728-000

- See page 208 for mounting dimensions.
- (C) in contact plating column indicates captive contact.
- See page 6 for alternate body plating information.



## Straight Adapters

**Figure 1**  
 (Straight jack-jack;  
 connects two plugs)



**Figure 2**  
 (Straight plug-plug;  
 connects two jacks)

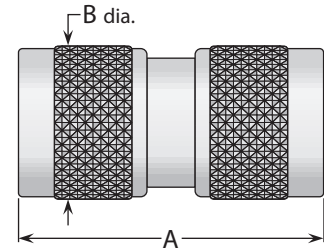
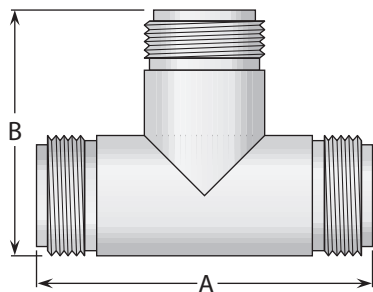
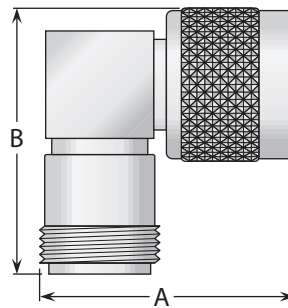


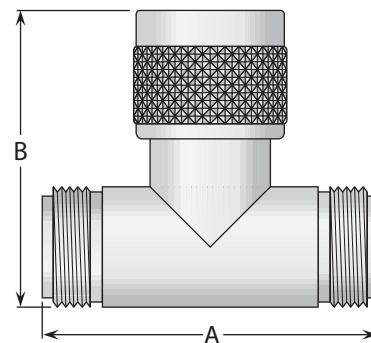
Figure	Dimensions		Plating		Delta P/N
	A	B	Body	Contact	
1	1.75	.660	Nickel	Gold (C)	1828000N000-000
2	1.59	.780	Nickel	Gold (C)	1827000N000-000

## Right Angle & Tee Adapters

**Figure 1**  
 (Right angle jack-plug;  
 connects one plug and one jack)



**Figure 2**  
 (Tee jack-jack-jack;  
 connects three plugs)



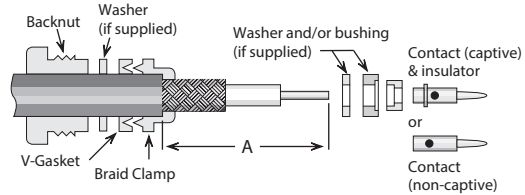
**Figure 3**  
 (Tee jack-plug-jack;  
 connects two plugs and one jack)

Figure	Dimensions		Plating		Delta P/N
	A	B	Body	Contact	
1	1.30	1.38	Nickel	Gold (C)	1829000N000-000
2	1.75	1.22	Nickel	Gold (C)	1838000N000-000
3	1.75	1.47	Nickel	Gold (C)	1830000N000-000

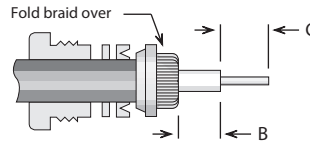
- (C) in contact plating column indicates captive contact.
- See page 6 for alternate body plating information.

## Assembly Procedure A

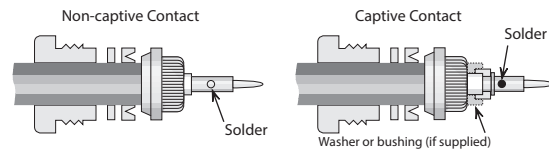
- 1) Trim cable jacket to dimension A.  
Slide backnut, washer, V-gasket, and braid clamp onto cable as shown.  
Cable jacket should bottom on step in braid clamp.



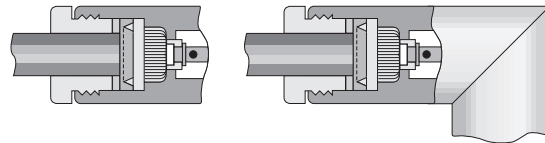
- 2) Comb braid wires out straight and fold back over front shoulder of braid clamp (braid wires should not overlap one another after folding). Trim braid wires flush with step of braid clamp. Trim cable dielectric and center conductor to dimensions B and C.



- 3) If support insulator is provided for RG-62 or 71 cable, insert into hollow in dielectric. Assemble rear bushing or washer (if supplied), rear insulator (if captive contact) and contact, and solder contact to center conductor. Rear of contact should be flush with cable dielectric end. For right angle connectors with access cap, omit this step entirely.



- 4) Insert prepared cable and hardware into body and tighten backnut. For right angle connectors with access cap, solder center conductor into slot in contact and tighten access cap.

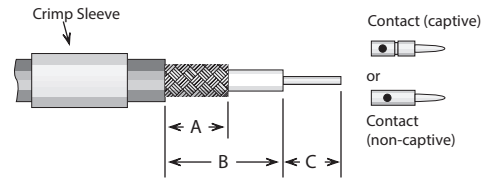


### Trim Codes For Assembly Procedure A

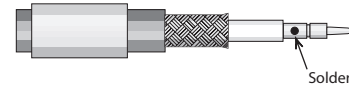
Code	A	B	C	Code	A	B	C
A/01	.375 (3/8)	.047 (3/64)	.203 (13/64)	A/20	.375 (3/8)	.047 (3/64)	.172 (11/64)
A/02	.375 (3/8)	.109 (7/64)	.203 (13/64)	A/21	.500 (1/2)	.313 (5/16)	.172 (11/64)
A/03	.438 (7/16)	.250 (1/4)	.188 (3/16)	A/22	.375 (3/8)	.188 (3/16)	.141 (9/64)
A/04	.281 (9/32)	.047 (3/64)	.125 (1/8)	A/23	.438 (7/16)	.078 (5/64)	.172 (11/64)
A/05	.313 (5/16)	.125 (1/8)	.109 (7/64)	A/24	.500 (1/2)	.094 (3/32)	.141 (9/64)
A/06	.594 (19/32)	.391 (25/64)	.156 (5/32)	A/25	.438 (7/16)	.141 (9/64)	.172 (11/64)
A/07	.375 (3/8)	.047 (3/64)	.125 (1/8)	A/26	.625 (5/8)	.281 (9/32)	.250 (1/4)
A/08	.281 (9/32)	.109 (7/64)	.094 (3/32)	A/27	.688 (11/16)	.281 (9/32)	.125 (1/8)
A/09	.344 (11/32)	.109 (7/64)	.094 (3/32)	A/28	.656 (21/32)	.297 (19/64)	.250 (1/4)
A/10	.406 (13/32)	.109 (7/64)	.203 (13/64)	A/29	.688 (11/16)	.125 (1/8)	.313 (5/16)
A/11	.500 (1/2)	.281 (9/32)	.156 (5/32)	A/30	.688 (11/16)	.469 (15/32)	.156 (5/32)
A/12	.343	.040	.219	A/31	.700 (21/32)	.453 (29/64)	.250 (1/4)
A/13	.375 (3/8)	.125 (1/8)	.156 (5/32)	A/32	.313 (5/16)	.078 (5/64)	.188 (3/16)
A/14	.355	.090	.188 (3/16)	A/33	.250 (1/4)	.078 (5/64)	.094 (3/32)
A/15	.425	.094 (3/32)	.259	A/34	.250 (1/4)	.062 (1/16)	.109 (7/64)
A/16	.328 (21/64)	.094 (3/32)	.188 (3/16)	A/35	.837	.575	.150
A/17	.375 (3/8)	.109 (7/64)	.125 (1/8)	A/36	.450	.250	.150
A/18	.375 (3/8)	.062 (1/16)	.172 (11/64)	A/37	.281	.038	.188
A/19	.375 (3/8)	.188 (3/16)	.094 (3/32)	A/38	.281	.069	.156

## Assembly Procedure B

- 1) Trim cable per chart. Slide crimp sleeve back onto cable.



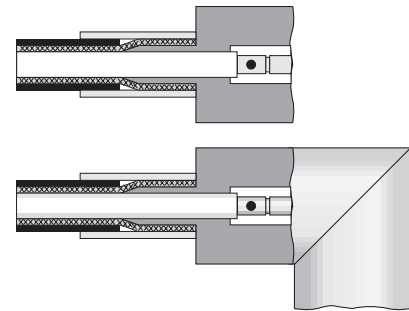
- 2) If support insulator is provided for RG-62 or 71 cable, insert into hollow in dielectric. Solder contact onto center conductor; back of contact flush with trimmed end of cable dielectric (omit this step for right angle connectors with access caps). Flare cut end of braid slightly by rotating dielectric.



- 3) Insert cable/contact into rear of body, with all braid wires on outside of crimp tail.
  - a) For captive contact connectors, push cable in until contact snaps into insulator.
  - b) For noncaptive contact connectors, push cable in until cable dielectric bottoms in connector.
  - c) For right angle or tee connectors with access caps, push cable in until end of braid touches connector body shoulder, and cable center conductor rests in contact slot.

Trim excess braid wires even with shoulder of body. Slide crimp sleeve forward until flush with body and crimp (see page 211 for hex die sizes).

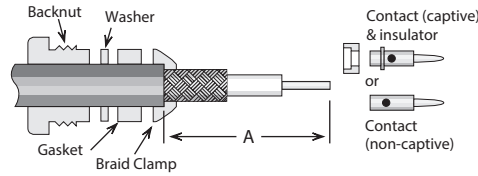
For right angle or tee connectors with access caps: Solder center conductor into contact slot, assemble insulator disc (if supplied), then press cap into body until seated or screw into place.



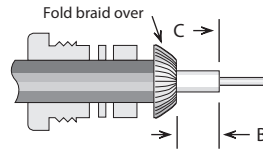
### Trim Codes For Assembly Procedure B

Code	A	B	C	Code	A	B	C
B/01	.320	.470	.140	B/20	.250	.375	.156
B/02	.422	.578	.172	B/21	.425	.550	.156
B/03	.406	.500	.187	B/22	.375	.500	.156
B/04	.285	.505	.140	B/23	.281	.469	.125
B/05	.335	.460	.140	B/24	.250	.700	.109
B/06	.187	.437	.219	B/25	.343	.775	.125
B/07	.422	.610	.156	B/26	.343	.437	.109
B/08	.422	.562	.219	B/27	.313	.437	.187
B/09	.313	.610	.203	B/28	.219	.271	.078
B/10	.280	.436	.187	B/29	.200	.320	.060
B/11	.430	.542	.156	B/30	.500	.650	.219
B/12	.300	.434	.156	B/31	.350	.840	.150
B/13	.300	.447	.156	B/32	.175	.260	.095
B/14	.420	.645	.187	B/33	.195	.270	.045
B/15	.300	.420	.120	B/34	.150	.250	.105
B/16	.312	.609	.125	B/35	.195	.280	.170
B/17	.250	.500	.156	B/36	.150	.325	.090
B/18	.437	.562	.109	B/37	.195	.295	.075
B/19	.343	.437	.156	B/38	.150	.225	.095
				B/39	.250	.300	.135

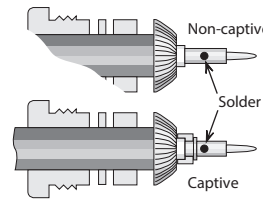
## Assembly Procedure C



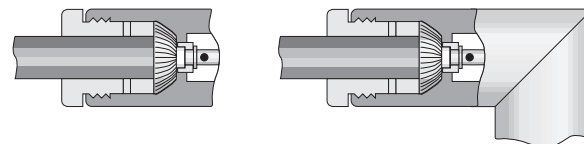
- 1) Trim cable jacket to dimension A. Slide backnut, washer, gasket, and braid clamp onto cable as shown. Cable jacket should bottom on step in braid clamp.



- 2) Comb braid wires out straight and fold back over front shoulder of braid clamp (braid wires should not overlap one another after folding). Trim braid wires flush with edge of braid clamp. Trim cable dielectric and center conductor to dimensions B and C.



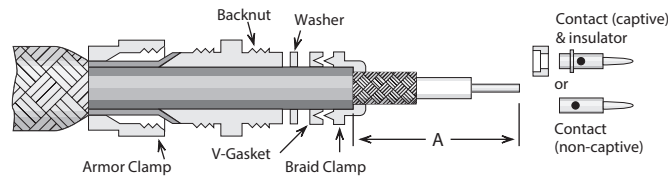
- 3) If support insulator is provided for RG-62 or 71 cable, insert into hollow in dielectric. Assemble rear insulator (if captive contact) and contact, and solder contact to center conductor. Rear of contact should be flush with cable dielectric end.



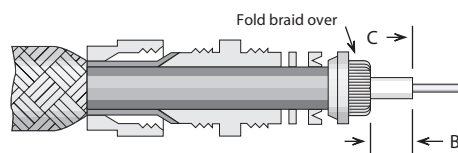
- 4) Insert prepared cable and hardware into body and tighten backnut. For right angle connectors with access cap, solder cable center conductor to slot in contact and tighten access cap.

Trim Codes			
Code	A	B	C
C/01	.656 (21/32)	.141 (9/64)	.250 (1/4)
C/02	.500 (1/2)	.125 (1/8)	.250 (1/4)
C/03	.450	.136	.187
C/04	.375 (3/8)	.109 (7/64)	.125 (1/8)
C/05	.375 (3/8)	.062 (1/16)	.250 (1/4)
C/06	.500 (1/2)	.188 (3/16)	.125 (1/8)
C/07	.575	.438	.094
C/08	.625 (5/8)	.141 (9/64)	.219 (7/32)

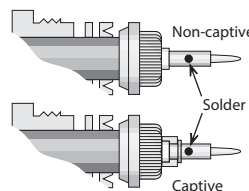
## Assembly Procedure D



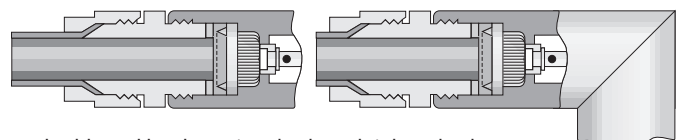
- 1) Slide armor clamp over cable. Push armor back to expose cable end. Slide backnut, washer (if supplied), gasket, and braid clamp onto cable as shown. Cable jacket should bottom on step in braid clamp. Trim cable jacket to dimension A.



- 2) Comb braid wires out straight and fold back over front shoulder of braid clamp (braid wires should not overlap one another after folding). Trim braid wires flush with edge of braid clamp. Trim cable dielectric and center conductor to dimensions B and C.



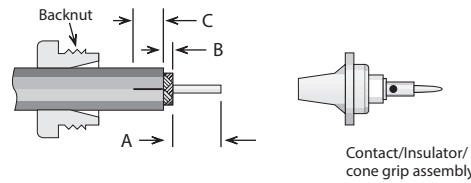
- 3) Assemble rear insulator (if captive contact) and contact, and solder contact to center conductor. Rear of contact should be flush with cable dielectric end.



- 4) Insert prepared cable and hardware into body and tighten backnut. Trim armor to fit between armor clamp and braid clamp. Tighten armor clamp.

Trim Codes			
Code	A	B	C
D/01	.375 (3/8)	.047 (3/64)	.250 (1/4)
D/02	.500 (1/2)	.188 (3/16)	.219 (7/32)
D/03	.344 (11/32)	.047 (3/64)	.219 (7/32)
D/04	.313 (5/16)	.047 (3/64)	.172 (11/64)
D/05	.625 (5/8)	.281 (9/32)	.250 (1/4)
D/06	.313 (5/16)	.062 (1/16)	.109 (7/64)

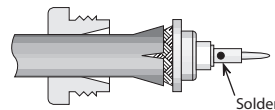
## Assembly Procedure E



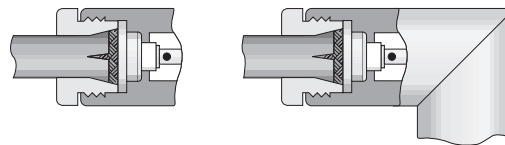
- 1) Slide backnut onto cable as shown. Trim cable to dimensions A and B as shown. Slit jacket to dimension C in two places, 180° apart.

### Trim Codes

Code	A	B	C
E/01	.250 (1/4)	.141 (9/64)	.313 (5/16)
E/02	.219 (7/32)	.063 (1/16)	.250 (1/4)
E/03	.250 (1/4)	.031 (1/32)	.250 (1/4)



- 2) Slide cone/insulator/contact assembly under braid until braid is flush with shoulder. Solder contact to center conductor.

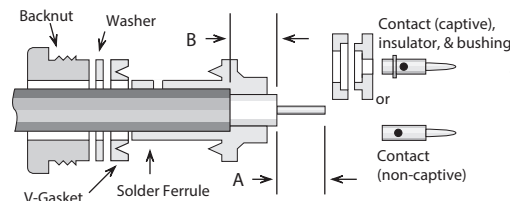


- 3) Insert prepared cable and hardware into body; tighten assembly by holding grip stationary and turning body.

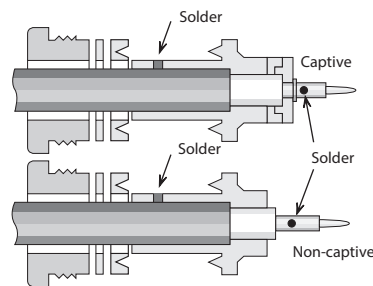
## Assembly Procedure F

### Trim Codes

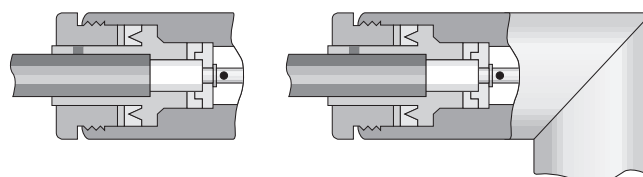
Code	A	B
F/01	.250 (1/4)	.219 (7/32)
F/02	.250 (1/4)	.172 (11/64)
F/03	.188 (3/16)	.188 (3/16)
F/04	.109 (7/64)	.265 (17/64)
F/05	.156 (5/32)	.250 (1/4)
F/06	.219 (7/32)	.250 (1/4)
F/07	.156 (5/32)	.172 (11/64)
F/08	.109 (7/64)	.219 (7/32)



- 1) Trim cable per chart. Slide backnut, washer, v-gasket, and solder ferrule onto cable. Trimmed end of cable jacket should bottom on step in solder ferrule.

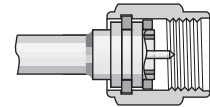
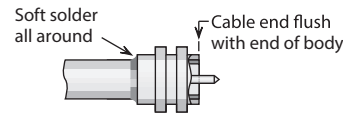
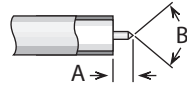
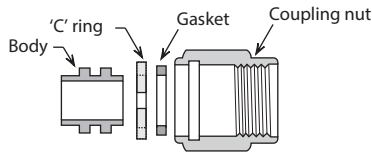


- 2) Solder ferrule to cable jacket as shown. Retrim cable dielectric to proper length if it has extruded from soldering heat. Slide bushing and rear insulator over cable dielectric if captive contact. Solder contact onto center conductor; back of contact flush with trimmed end of cable dielectric.



- 3) Insert prepared cable and hardware into body and tighten backnut.

## Assembly Procedure G



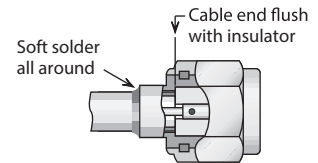
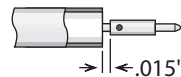
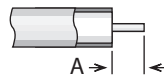
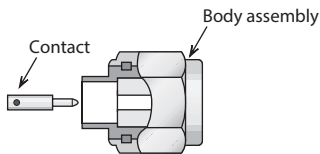
Trim Codes		
Code	A	B
G/01	.090	70-90°

1) Trim cable as shown. Remove any burrs from jacket and center conductor.

2) Soft solder cable jacket to body, making sure that end of cable is flush with end of body. After solder joint has cooled, retrim any protruding dielectric flush with end of body.

3) Assemble 'C' ring and gasket to body. Compress 'C' ring and slide body assembly into coupling nut until ring is seated in groove.

## Assembly Procedure H



Trim Codes	
Code	A
H/01	.090
H/02	.060
H/03	.115
H/04	.150

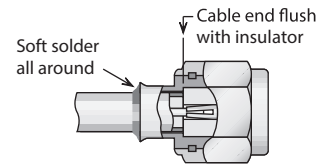
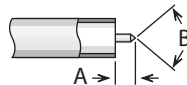
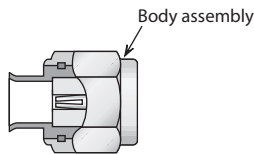
1) Trim cable as shown. Remove any burrs from jacket and center conductor.

2) Solder contact to center conductor, fixturing to maintain gap as shown. Remove any excess solder from outside of contact.

3) Insert cable into body and solder cable jacket to body, keeping end of cable flush with insulator as shown.

Plug body assembly and contact shown; procedure is identical for jack connectors.

## Assembly Procedure I



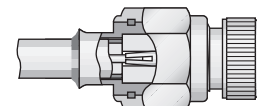
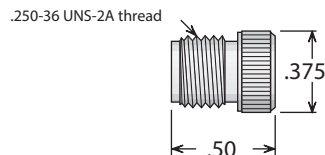
Trim Codes		
Code	A	B
I/01	.090	70-90°

1) Trim cable as shown. Remove any burrs from jacket and center conductor.

2) Insert cable into body and solder cable jacket to body, keeping end of cable flush with insulator as shown.

Plug body assembly and contact shown; procedure is identical for jack connectors.

### Cable Positioner



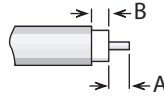
For .085" Cable:  
P/N 63-10072-2

For .141" Cable:  
P/N 63-10072-1

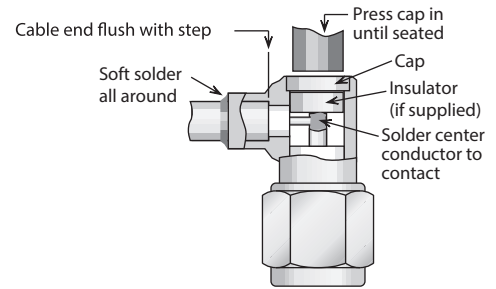
Using this positioner in the final step of assembly procedure H or I (for plugs only) will ensure that the contact and insulator are retained in the proper position to meet MIL-C-39012 requirements. The positioner should be screwed finger-tight into the mating end of the connector (as shown at right) before the cable jacket is soldered to the body assembly.

## Assembly Procedure J

Trim Codes		
Code	A	B
J/01	.109	.047
J/02	.059	.039
J/03	.059	.079
J/04	.050	.059

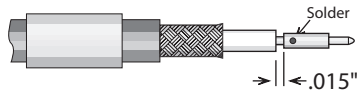
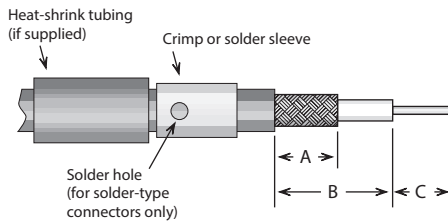


1) Trim cable as shown. Remove any burrs from jacket and center conductor.



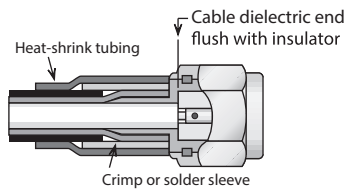
2) Soft solder cable jacket to body, making sure that end of cable is flush with step in body. Solder center conductor into contact slot, assemble insulator disc (if supplied), then press cap into body until seated or screw into place.

## Assembly Procedure K



1) Trim cable per chart. Slide crimp (or solder) sleeve and heat-shrink tubing (if supplied) back onto cable.

2) Solder contact onto center conductor, fixturing to maintain gap as shown. Flare cut end of braid slightly by rotating dielectric.



3) Insert cable/contact into rear of body, with all braid wires on outside of crimp tail. Push cable in until cable dielectric bottoms in connector. Trim excess braid wires even with shoulder of body. Slide crimp sleeve forward until flush with body and crimp (see page 211 for hex die sizes). (For solder-type connectors, solder braid to body and sleeve through hole in sleeve.) Slide heat-shrink tubing into place and shrink with hot-air gun.

Plug body assembly and contact shown; procedure is identical for jack connectors.

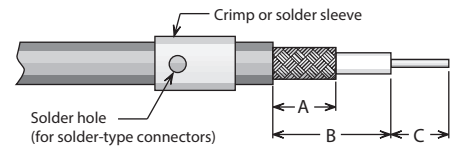
Trim Codes							
Code	A	B	C	Code	A	B	C
K/01	.250	.270	.110	K/07	.220	.290	.135
K/02	.200	.270	.140	K/08	.420	.620	.090
K/03	.225	.290	.110	K/09	.090	.135	.160
K/04	.225	.330	.110	K/10	.250	.415	.115
K/05	.250	.330	.110	K/11	.250	.400	.150
K/06	.250	.315	.095	K/12	.282	.390	.140

## Assembly Procedure L

### Trim Codes

Code	A	B	C
L/01	.250	.438	.109
L/02	.125	.219	.109
L/03	.234	.344	.109
L/04	.195	.270	.050
L/05	.095	.155	.050
L/06	.281	.390	.070

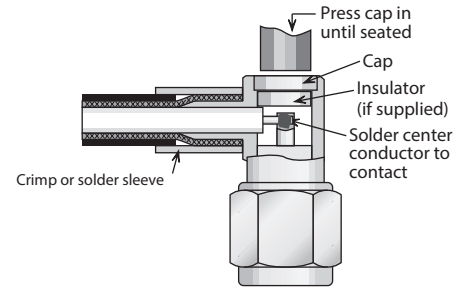
- 1) Trim cable per chart. Slide crimp (or solder) sleeve onto cable.



- 2) Insert cable into rear of body, with all braid wires on outside of crimp tail. Push cable in until end of braid touches connector body shoulder and center conductor rests in contact slot.

Slide crimp sleeve forward until flush with body and crimp (see page 211 for hex die sizes). (For solder-type connectors, solder braid to body and sleeve through hole in sleeve.)

Solder center conductor into contact slot, assemble insulator disc (if supplied), then press cap into body until seated or screw into place.

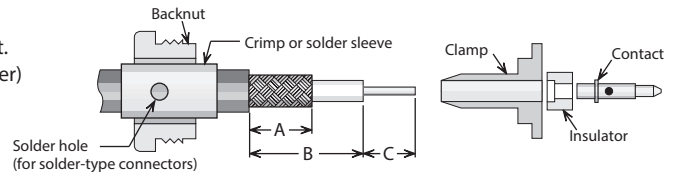


## Assembly Procedure M

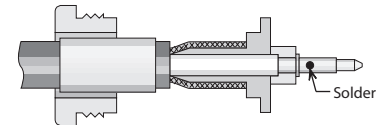
### Cable Trim Codes

Code	A	B	C
M/01	.281	.390	.140

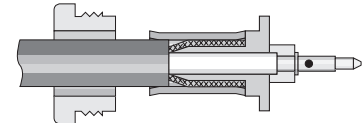
- 1) Trim cable per chart. Slide crimp (or solder) sleeve and backnut onto cable.



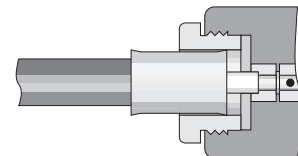
- 2) Flare cut end of braid slightly by rotating dielectric. Insert cable into rear of clamp, with all braid wires on outside of crimp tail. Slide insulator over cable dielectric until it is flush with front of clamp, and cable insulation bottoms inside insulator. Slide contact onto center conductor, with contact shoulder flush with front of insulator. Solder contact to center conductor.



- 3) Slide crimp sleeve forward until flush with clamp shoulder; crimp as close to shoulder as possible. (see page 211 for hex die sizes). (For solder-type connectors, solder braid to body and sleeve through hole in sleeve.)



- 4) Insert prepared cable into back of body. Slide nut forward and tighten to 12–15 inch-pounds.



## Crimp Tools For Flexible Cable



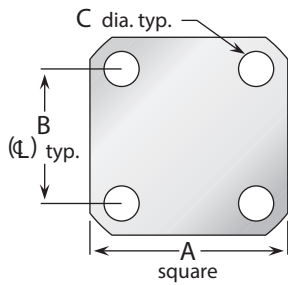
Frame only—P/N M22520/5-01 —Use with interchangeable dies listed below.

Cable Group*	Hex Die Size	Die Set P/N	Closure
2, 3, 4	.429 hex, .400 wide	M22520/5-61	A
5, 6	.213 hex, .400 wide	M22520/5-19	B
7	.255 hex, .400 wide	M22520/5-19	A
9	.128 hex, .400 wide	M22520/5-35	B
10	.151 hex, .400 wide	M22520/5-37	B
11	.105 hex, .400 wide	M22520/5-33	B

\* For Delta cable groups. See MIL-PRF-39012 specifications for die sizes used with M39012 cable groups.

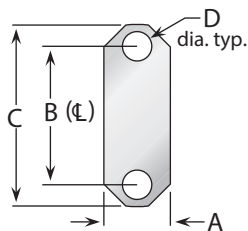


## Connector Flanges (Panel Mounted Connectors)



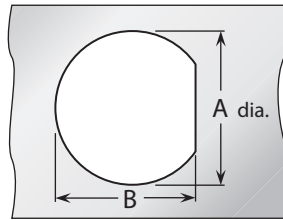
4-hole flanges			
Figure	A	B	C
04	1/2	.360	.089
05	1/2	.340	.102
07	11/16	.500	#3-56 tap
08	11/16	.500	.136
09	11/16	.500	.125
10	11/16	.500	.120
12	11/16	.500	.109
18	3/4	.531	.136
26	1	.718	#6-32 tap
27	1	.718	#4-40 tap
30	1	.718	.166
32	1	.718	.136
32A	1	.718	.136*
33	1	.718	.125
34	1 3/32	.812	.150
36	1 3/16	.906	#6-32 tap
39	1 3/16	.906	.152
40	1 3/16	.906	.125
45	2	1.437	.257
91	.375	.250	.067
91A	.375	.232	.093

\* Countersunk to .245 dia.

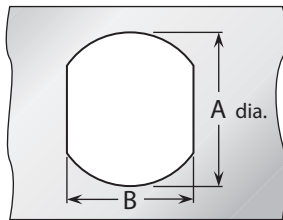


2-hole flanges				
Figure	A	B	C	D
92	.223	.481	.625	.102
92A	.260	.481	.625	.102
95	.640	1.015	1.30	.125

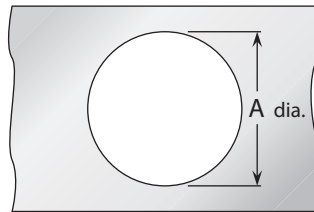
## Panel Cutouts (Bulkhead Mounted Connectors)



D-Hole		
Figure	A	B
51	.755	.723
54	.630	.598
55	.630	.583
57	.557	.531
59	.505	.473
62	.442	.410
63	.407	.362
65	.380	.348
66	.319	.292
67	.255	.236
68	.195	.176

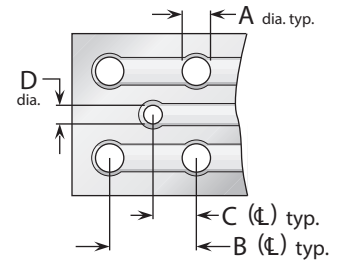


Double D-Hole		
Figure	A	B
69	.755	.692
72	.630	.536
75	.380	.341
84	.319	.278



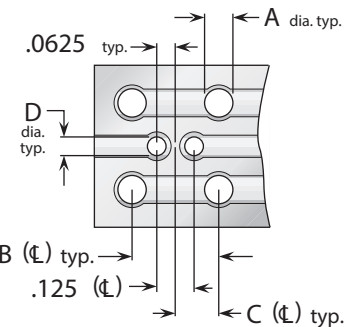
Round Hole	
Figure	A
82	.255
89	.380

## P.C. Board Drilling



(PCB traces are shown for illustrative purpose only, and are not representative of actual circuitry.)

Coaxial connectors				
Figure	A	B	C	D
PCB01	.067	.400	.200	.045
PCB02	.045	.500	.250	.045
PCB03	.067	.300	.150	.035
PCB05	.067	.200	.100	.055
PCB06	.067	.200	.100	.045
PCB07	.045	.177	.088	.045
PCB08	.032	.100	.050	.032



(PCB traces are shown for illustrative purpose only, and are not representative of actual circuitry.)

Twinax Connectors				
Figure	A	B	C	D
PCB04	.045	.500	.250	.045

## Delta Cable Groups

Group	Cables
1	1A RG-5, 5A, 5B, 21, 21A; M17/73, /162
	1B RG-6, 6A; M17/2
	1C RG-143, 143A, 212, 222; M17/73, /112, /162
2	2A RG-8, 8A, 213; M17/74
	2B RG-11, 11A; M17/6
3	3A RG-9, 9A, 9B, 214; M17/75
	3B RG-13A, 216; M17/77
	3C RG-225; M17/127
4	RG-393; M17/127
5	RG-58, 58A, 58C, 141, 141A; M17/28, /111
6	6A RG-55A, 142, 142A, 223, 400; M17/60, /84, /128
	6B RG-55, 55B, 142B; M17/60, /84
7	7A RG-59, 59A, 59B, 62, 62A, 62B, 62C, 210; M17/29, /30, /97
	7B RG-71, 71A, 71B; M17/90
8	8A RG-122; M17/54
	8B RG-180, 180A, 180B, 195; M17/95, /137
9	9A RG-174, 188, 188A, 316; M17/152
	9B RG-179A, 179B, 187, 187A; M17/94, /136
10	Double-Shielded RG-174, 316; M17/152
11	RG-178, 178A, 178B, 196, 196A; M17/93
12	.250" semi-rigid; RG-401; M17/129
13	.141" semi-rigid; RG-402; M17/130
14	.085" semi-rigid; RG-405; M17/133
15	RG-10, 12, 215; M17/6, /74
16	RG-14A, 217; M17/78, /165
17	RG-17A, 218
18	RG-18A, 219
19	RG-115A
20	RG-118A, 228A
21	RG-126
22	RG-302
23	RG-303
24	RG-304
25	Special 8X cable; contact factory for details.
26	Belden 8281
27	RG-108, 108A; M17/45
28	RG-22, 22A, 22B; M17/15
29	Belden 9207; Dearborn 6207; IBM 7362211
30	M17/176
31	AT&T 735A

## Cable Group Finder

Cable	Group	Cable	Group
RG-5, 5A, B	1A	RG-225	3C
RG-6, 6A	1B	RG-228A	20
RG-8, 8A	2A	RG-302	22
RG-9, 9A, B	3A	RG-303	23
RG-10	15	RG-304	24
RG-11, 11A	2B	RG-316	9A
RG-12	15	RG-316DS	10
RG-13A	3B	RG-393	4
RG-14A	16	RG-400	6A
RG-17A	17	RG-401	12
RG-18A	18	RG-402	13
RG-21, 21A	1A	RG-405	14
RG-22, 22A, B	28	M17/2	1B
RG-55, 55B	6B	M17/6	2B
RG-55A	6A	M17/15	28
RG-58, 58A, C	5	M17/28	5
RG-59, 59A, B	7A	M17/29	7A
RG-62, 62A, B, C	7A	M17/30	7A
RG-71, 71A, B	7B	M17/45	27
RG-108, 108A	27	M17/73	1A
RG-115A	19	M17/162	1A
RG-118A	20	M17/112	1C
RG-122	8A	M17/74	2A
RG-126	21	M17/75	3A
RG-141, 141A	5	M17/127	3C
RG-142, 142A	6A	M17/77	3B
RG-142B	6B	M17/60	6A
RG-143, 143A	1C	M18/84	6A
RG-174	9A	M17/128	6A
RG-174DS	10	M17/97	7A
RG-178, 178A, B	11	M17/54	8A
RG-179A, 179B	9B	M17/95	8B
RG-180, 180A, B	8B	M17/137	8B
RG-187, 187A	9B	M17/152	9A
RG-188, 188A	9A	M17/93	11
RG-195	8B	M17/129	12
RG-196, 196A	11	M17/130	13
RG-210	7A	M17/133	14
RG-212	1C	M17/78	16
RG-213	2A	M17/165	16
RG-214	3A	M17/176	30
RG-215	15	AT&T 735A	31
RG-217	16	Belden 8281	26
RG-218	17	Belden 9207	29
RG-219	18	Dearborn 6207	29
RG-222	1C	IBM 7362211	29
RG-223	6A		

Note: MIL-PRF-39012 QPL connectors have cable groups defined by the MIL specification, not the Delta cable groups shown here. See page 185 for M39012 cable groups.

## Warranty

We warrant our parts to be free of defects and workmanship for one year from purchase. During that time we will repair or replace (at our option) any parts found to be defective. The warranty does not apply to parts that have been modified, used in conditions exceeding Seller's, or military specifications, or disassembled. We will not, under any circumstances, be responsible for consequential or incidental damages or installation costs. No other warranties apply, and no other liability may be assumed or extended by representatives or distributors. The terms of the applicable warranty or warranties, as the case may be, as set forth herein are the sole and exclusive warranty terms that shall have any force or effect in the any product order, resulting from the quotation and such terms and in lieu of all other warranties, expressed or implied, including the implied warranties of merchantability and fitness for a particular purpose, which are hereby expressly excluded.



## Returns

Returns will be accepted only with a Return Authorization number issued by Delta, and are subject to inspection and acceptance upon arrival. Restocking charges will be determined prior to issuance of Return Authorization. All claims for shortages must be made within 30 days of receipt by customer.

## Ordering Information

Orders are subject to the terms and conditions on our order acknowledgement, which may only be modified by written agreement prior to sale. Order changes, cancellation, or termination will be accepted only with written approval from Delta Electronics Manufacturing.

## Copyright, Trademarks, & Patents

Entire contents copyright 2017, Delta Electronics Manufacturing Corporation. Reproduction rights are hereby granted for, and specifically limited to, printing or other reproduction of drawings and specifications for inclusion in specification or source control drawings, or purchasing procedures, by Delta customers only.

Heli-Grip<sup>®</sup>, PressMount<sup>®</sup>, and Global Manufacturer logo are trademarks. The Heli-Grip design is covered by U.S. and foreign patents

Delta Electronics Manufacturing Corporation  
416 Cabot Street, P.O. Box 53  
Beverly, MA 01915  
FSCM/CAGE 00795