

## GaAs PHEMT MMIC MEDIUM POWER AMPLIFIER, 7 - 15.5 GHz

### Typical Applications

The HMC441LH5 is a medium PA for:

- Telecom Infrastructure
- Military Radio, Radar & ECM
- Space Systems
- Test Instrumentation

### Features

- Gain: 5 dB
- Saturated Power: +21.5 dBm @ 25% PAE
- Single Positive Supply: +5V
- 50 Ohms Matched Input/Output
- Hermetic SMT Package, 25mm<sup>2</sup>
- Screening to MIL-PRF-38535 (Class B or S) Available

### Functional Diagram

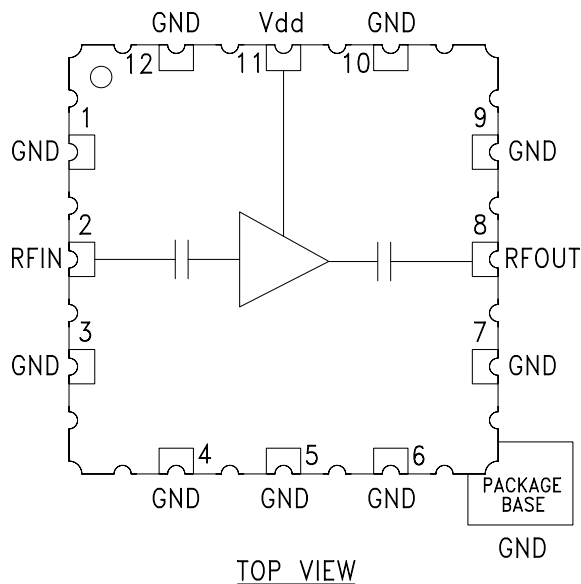

### General Description

The HMC441LH5 is a broadband 7 to 15.5 GHz GaAs PHEMT MMIC Medium Power Amplifier housed in a hermetic SMT leadless package. The amplifier provides 15 dB of gain and 21.5 dBm of saturated power at 25% PAE from a +5V supply. This 50 Ohm matched amplifier does not require any external components, and the RF I/Os are DC blocked, making it an ideal linear gain block or driver amplifier. The HMC441LH5 allows the use of surface mount manufacturing techniques and is suitable for high reliability military, industrial & space applications.

### Electrical Specifications, $T_A = +25^\circ\text{C}$ , $V_{dd} = 5\text{V}$

Parameter	Min.	Typ.	Max.	Min.	Typ.	Max.	Min.	Typ.	Max.	Min.	Typ.	Max.	Units
Frequency Range	7.0 - 8.0			8.0 - 13.0			13.0 - 14.0			14.0 - 15.5			GHz
Gain	11	14		13	16		12	15		10.5	13.5		dB
Gain Variation Over Temperature		0.015	0.02		0.015	0.02		0.015	0.02		0.015	0.02	dB/°C
Input Return Loss		11			13			10			8		dB
Output Return Loss		10			15			14			12		dB
Output Power for 1 dB Compression (P1dB)	15.5	18.5		17	20		16	19		16	19		dBm
Saturated Output Power (Psat)		20			21			21.5			21		dBm
Output Third Order Intercept (IP3)		30			32			32			32		dBm
Noise Figure		5.0			4.75			4.75			5.0		dB
Supply Current (I <sub>dd</sub> )		90	115		90	115		90	115		90	115	mA

**GaAs PHEMT MMIC MEDIUM POWER AMPLIFIER, 7 - 15.5 GHz**

**Broadband Gain & Return Loss**

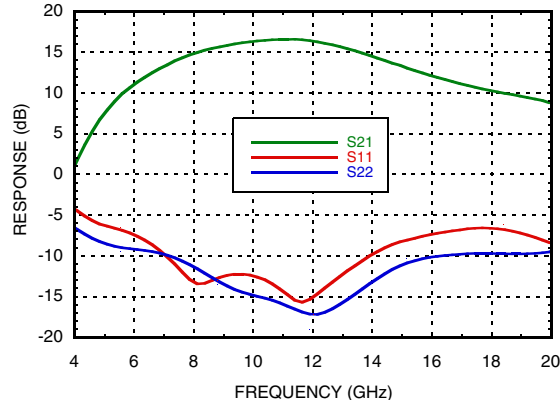

**Gain vs. Temperature**

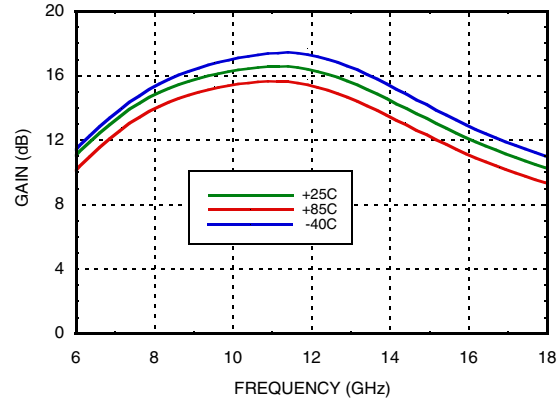

**Input Return Loss vs. Temperature**

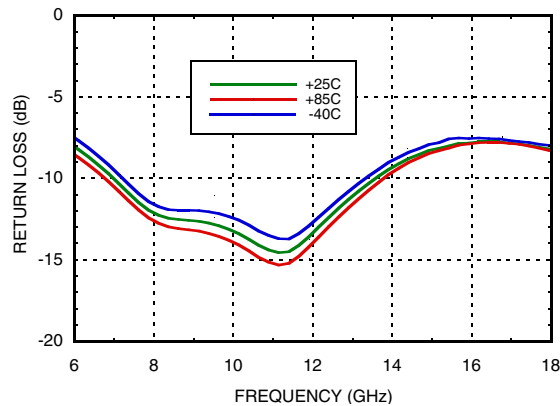

**Output Return Loss vs. Temperature**

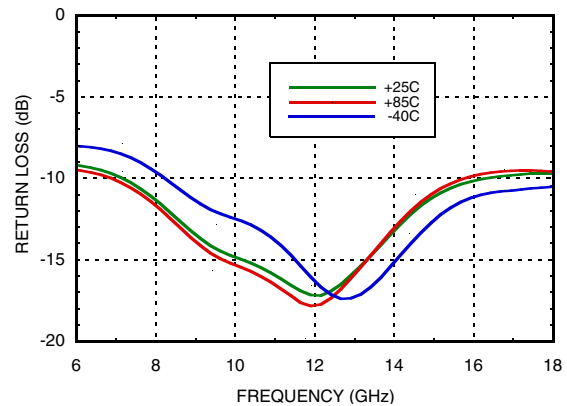

**P1dB vs. Temperature**

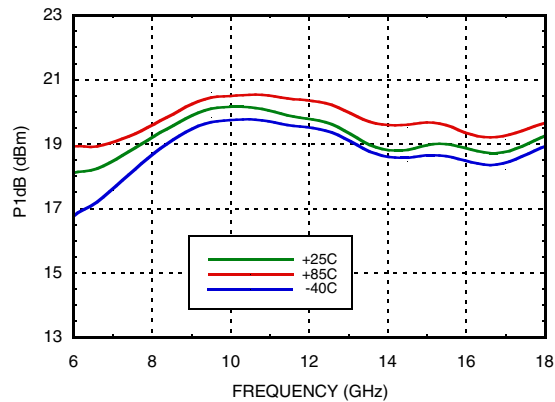

**Psat vs. Temperature**

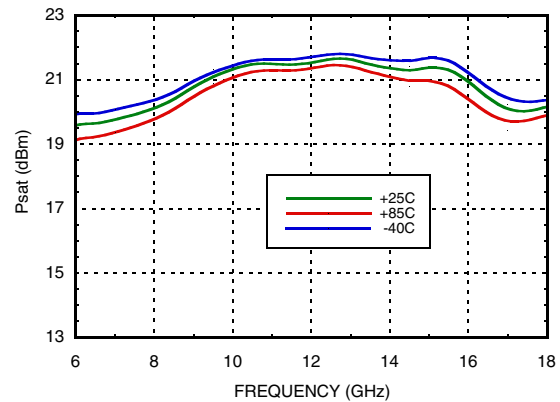

**GaAs PHEMT MMIC MEDIUM POWER AMPLIFIER, 7 - 15.5 GHz**

**Power Compression @ 12 GHz**

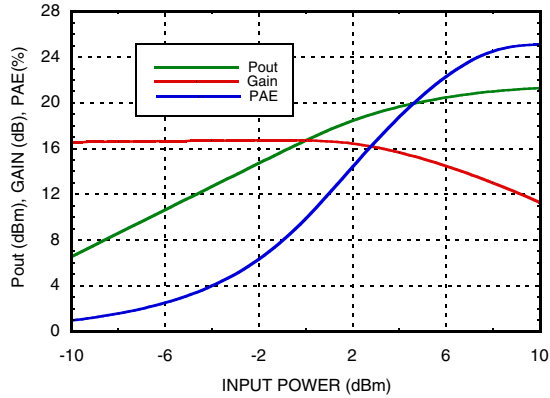

**Output IP3 vs. Temperature**

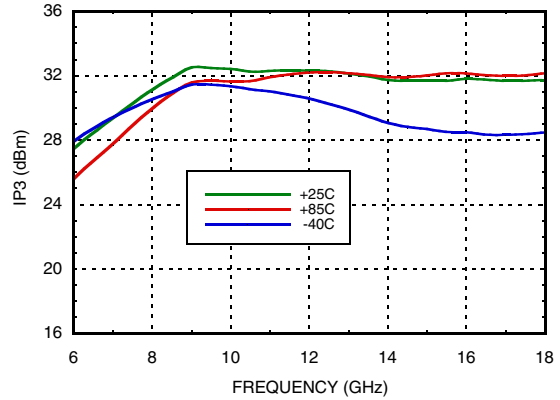

**Gain, Power & Output IP3 vs. Supply Voltage @ 12 GHz**

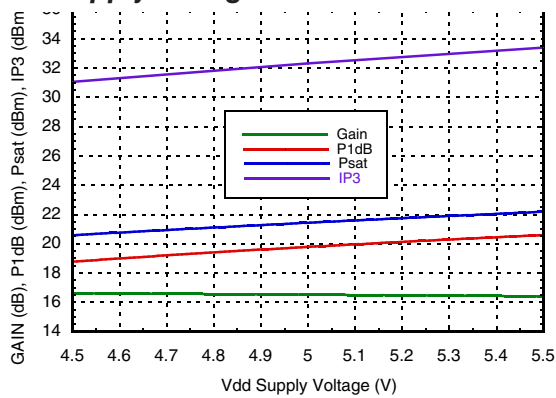

**Noise Figure vs. Temperature**

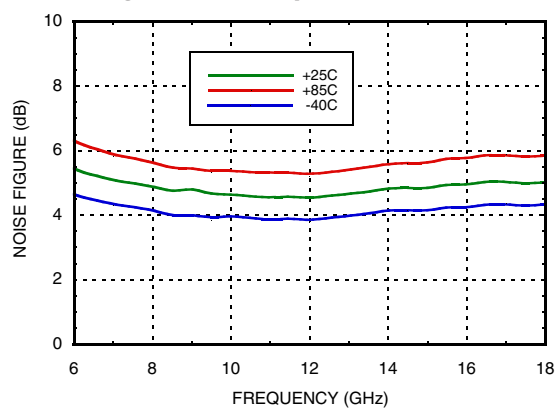

**Reverse Isolation vs. Temperature**

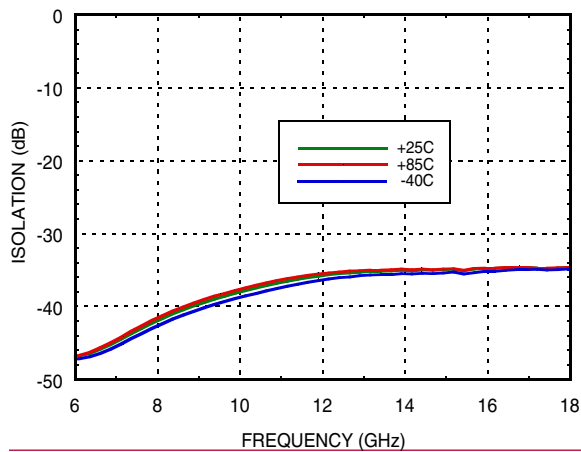

**Additive Phase Noise Vs Offset Frequency, RF Frequency = 8 GHz, RF Input Power = 5 dBm (P1dB)**

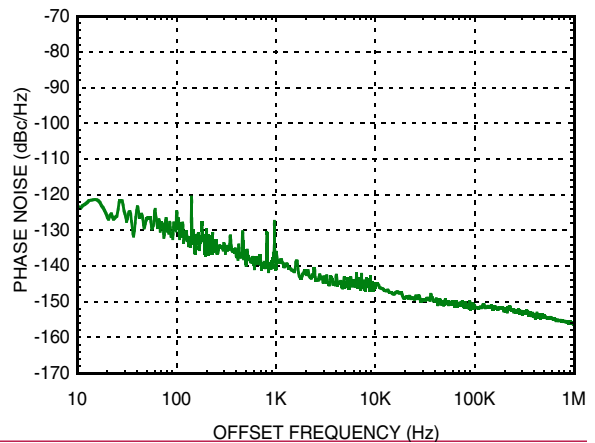

## GaAs PHEMT MMIC MEDIUM POWER AMPLIFIER, 7 - 15.5 GHz

### Absolute Maximum Ratings

Drain Bias Voltage (Vdd)	+6 Vdc
RF Input Power (RFIN)(Vdd = +5Vdc)	+15 dBm
Channel Temperature	175 °C
Continuous P <sub>diss</sub> (T = 85 °C) (derate 8.4 mW/°C above 85 °C)	0.76 W
Thermal Resistance (channel to ground paddle)	118.8 °C/W
Storage Temperature	-65 to +150 °C
Operating Temperature	-40 to +85 °C

### Typical Supply Current vs. Vdd

Vdd (V)	I <sub>dd</sub> (mA)
+5.5	92
+5.0	90
+4.5	88

Note: Amplifier will operate over full voltage range shown above



ELECTROSTATIC SENSITIVE DEVICE  
OBSERVE HANDLING PRECAUTIONS

### Outline Drawing

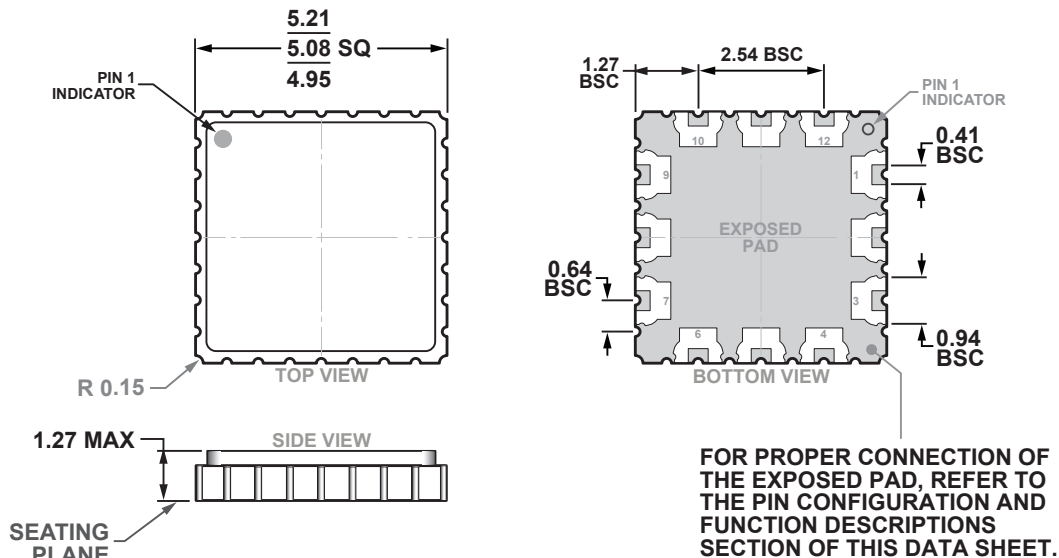

PKG-0101000

12-19-2016-A

12-Terminal Ceramic Leadless Chip Carrier [LCC]  
(E-12-3)

Dimensions shown in millimeters.

### Package Information

Part Number	Package Body Material	Lead Finish	MSL Rating	Package Marking <sup>[2]</sup>
HMC441LH5	Ceramic and Kovar	Gold	MSL1 <sup>[1]</sup>	H441 XXXX

[1] Max peak reflow temperature of 250 °C

[2] 4-Digit lot number XXXX

## GaAs PHEMT MMIC MEDIUM POWER AMPLIFIER, 7 - 15.5 GHz

### Pin Descriptions

Pin Number	Function	Description	Interface Schematic
1, 3-7, 9, 10, 12	GND	These pins and package bottom must be connected to RF/DC ground.	
2	RFIN	This pin is AC coupled and matched to 50 Ohms.	
8	RFOUT	This pin is AC coupled and matched to 50 Ohms.	
11	Vdd	Power Supply Voltage for the amplifier. External bypass capacitors are recommended.	

### Application Circuit

Component	Value
C1	100 pF
C2	1,000 pF
C3	4.7 μF

