

Standard Features

- **Protection Level:** IP66 (NEMA 4X)
- **Technical:** Smooth or Knockout Sidewalls
Gray or Tinted Transparent Cover ^①
Multiple Enclosure Mounting Options
- **Enclosure Material:** Polystyrene or Polycarbonate
- **Gasket Material:** Polyurethane
- **Color:** Light Gray
- **Temperature Range:** Polystyrene
-40°C to 70°C (-40°F to 158°F)
Polycarbonate
-35°C to 120°C (-31°F to 248°F)
- **Accessories:** See section below



Smooth Sidewalls

Ordering Information	Height mm (in)	Polystyrene				Polycarbonate			
		Cat. No.	Type	Cover Color	Std. Pk.	Cat. No.	Type	Cover Color	Std. Pk.
Enclosure - low cover	90 mm (3.54 in)	110-408	PS 2518-9-o	gray	1	120-408	PC 2518-9-o	gray	1
Enclosure - high cover	111 mm (4.37 in)	110-908	PS 2518-11-o	gray	1	120-908	PC 2518-11-o	gray	1
Enclosure - top hat cover	165 mm (6.50 in)	109-408	PS 2518-16-o	gray	1	121-408	PC 2518-16-o	gray	1
Enclosure - low cover	90 mm (3.54 in)	111-008	PS 2518-9-to	trans.	1	130-008	PC 2518-9-to	trans.	1
Enclosure - high cover	111 mm (4.37 in)	111-508	PS 2518-11-to	trans.	1	130-508	PC 2518-11-to	trans.	1
Enclosure - top hat cover	165 mm (6.50 in)	112-008	PS 2518-16-to	trans.	1	131-008	PC 2518-16-to	trans.	1

Sidewalls with PG Knockouts (metric available)

Ordering Information	Height mm (in)	Polystyrene				Polycarbonate			
		Cat. No.	Type	Cover Color	Std. Pk.	Cat. No.	Type	Cover Color	Std. Pk.
Enclosure - low cover	90 mm (3.54 in)	115-408	PS 2518-9	gray	1	125-408	PC 2518-9	gray	1
Enclosure - high cover	111 mm (4.37 in)	115-908	PS 2518-11	gray	1	125-908	PC 2518-11	gray	1
Enclosure - top hat cover	165 mm (6.50 in)	114-408	PS 2518-16	gray	1	126-408	PC 2518-16	gray	1
Enclosure - low cover	90 mm (3.54 in)	116-008	PS 2518-9-t	trans.	1	135-008	PC 2518-9-t	trans.	1
Enclosure - high cover	111 mm (4.37 in)	116-508	PS 2518-11-t	trans.	1	135-508	PC 2518-11-t	trans.	1
Enclosure - top hat cover	165 mm (6.50 in)	117-008	PS 2518-16-t	trans.	1	136-008	PC 2518-16-t	trans.	1

RK Enclosures with Terminal Blocks

Ordering Information	Height	Cat. No.	Type	Cover Color	Std. Pk.
Enclosure - 32 pole/10 AWG Terminal	90 mm (3.54 in)	625-404	RK2518	gray	1
Enclosure - DIN Rail only (TS35)	90 mm (3.54 in)	625-916	RK2518	gray	1

Accessories

Ordering Information	Cat. No.	Type	Std. Pk.
Mounting Plate	195-008	MP2518	1
DIN Rail TS35-216mm	Z-652	TS 35/216	1
Hinge Kit Set	190-005	HK2	1
Mounting Tab Kit	194-001	MT1	1

Please refer to pages 106-113 for additional accessories and detailed information.

^① Clear transparent lids available upon request

Dimensions

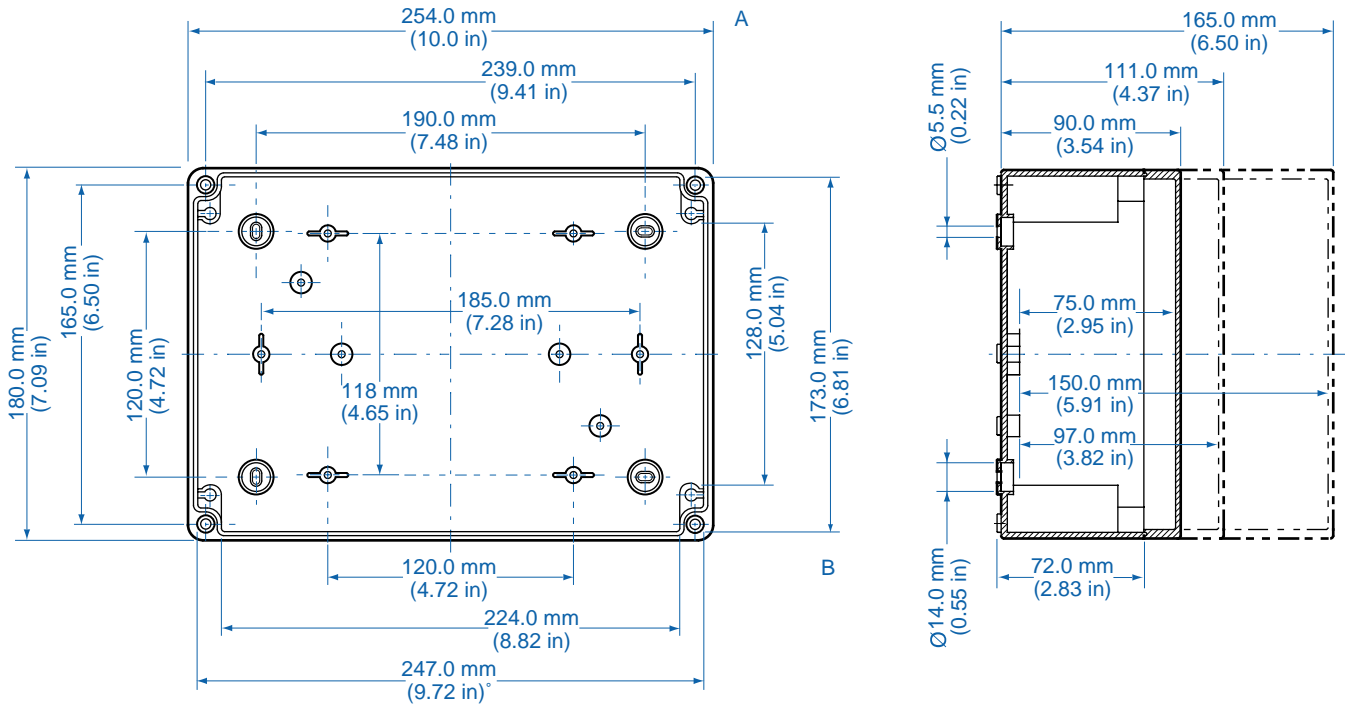

Knockout Positions [®] Side A

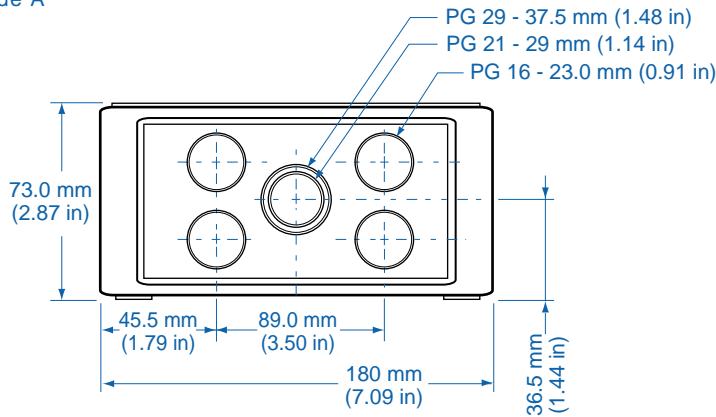

Side B

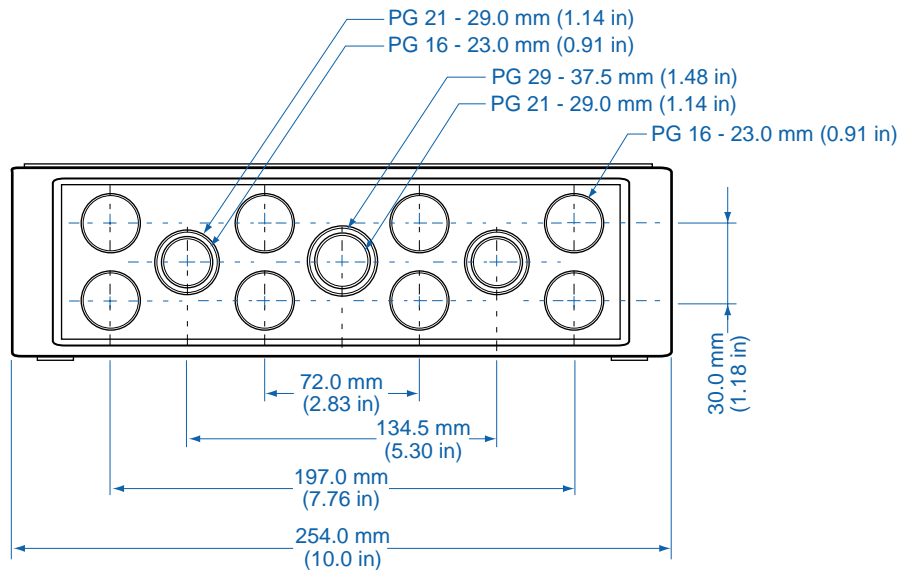

[®] Metric knockouts available upon request