

General Description

Delta TNC connectors are compact, 50Ω impedance connectors with 7/16-28 threaded coupling, similar in size to BNC connectors but with better electrical characteristics. They are best suited for use with cables in the range of .150" to .250" diameter, but are available for other cables from .090" to over .75" diameter. Many of our TNC connectors are available as MIL-PRF-39012 QPL versions. These types are listed starting on page 198. Our extensive line of TNC receptacles includes configurations for virtually any packaging requirement, and we can supply any adapter or accessory you need to complete your system design. Adapters between TNC and other series are shown starting on page 176.

As with our other connector series, Delta's customer-driven design results in TNC series connectors with practical and unique features that make your design and assembly process easier. Some of these include:

- Heli-Grip cable connectors for fast, reliable assembly to flexible cable without special tooling.
- PressMount receptacles (page 147) mount securely in a single round hole, saving space on your components and reducing your housing fabrication costs.
- Panel receptacles with flange sizes to match the same hole pattern as standard SMA or type N connectors, letting you drill one hole pattern and mount BNC, N, SMA, TNC, or 7/16 series connectors as needed.
- TNC connectors with polarized interfaces (page 152) prevent mismatching and meet FCC Part 15.203 requirements.
- Keying baskets and keyed plugs (page 149) provide numerous polarizations in applications incorporating multiple connector pairs.

Our TNC series product line is still growing, so please call if you don't see what you need.

TNC Configurations

Straight Cable Plugs	137	Bulkhead Jack Receptacles	146
Right Angle Cable Plugs	139	PressMount Receptacles.....	147
Straight Cable Jacks	141	Stripline Receptacles	147
Bulkhead Cable Jacks	142	Resistive Terminations	148
Panel Cable Jacks	143	Dust Caps.....	148
Panel Jack Receptacles (square flange)	144	Keying Baskets.....	149
Right Angle Panel Jack Receptacles	145	In-Series Adapters	150
Panel Plug Receptacles.....	145	Polarized Plugs and Jacks	152

TNC Specifications*

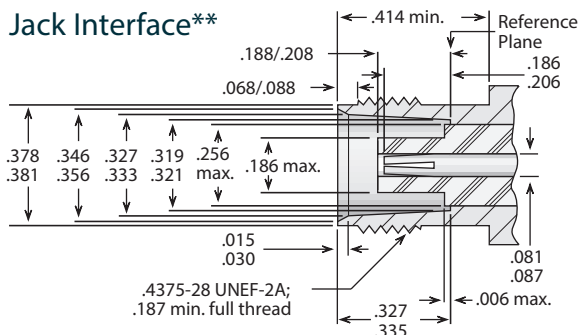
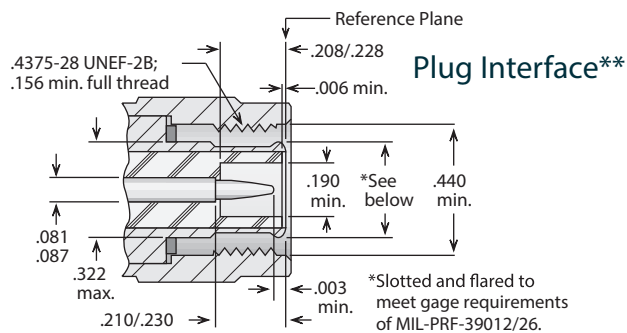

**Some proportions altered to illustrate detail.

Electrical:

Nominal Impedance: 50 ohms.
 Frequency Range: DC-11 GHz.
 Voltage Rating: 500 volts RMS.
 Dielectric Withstanding Voltage : 1,500 VRMS.
 Insulation Resistance: 5,000 megohms.

Materials/Finishes:

Insulators: Teflon per ASTM D1710.
 Male Contacts: Brass per ASTM B16.
 Female Contacts: Beryllium Copper per ASTM B196.
 Contact Plating : Silver per ASTM B700, or Gold per MIL-DTL-45204.
 Gaskets: Silicone rubber per ZZ-R-765, Class II, Grade 50.
 Other Metal Parts: Brass per ASTM B16, plated: Silver per ASTM B700, or Nickel per AMS-QQ-N-290.

All other specifications are in accordance with the latest issues of MIL-PRF-39012, or MIL-A-55339, or other applicable MIL specifications, and interfaces are in accordance with MIL-STD-348.

*These specifications are typical and may not apply to all connectors. Detailed specifications for individual connectors are available on request.

Straight Plug - Military Clamp For Flexible Cable

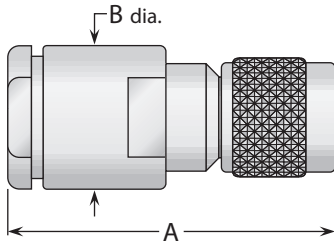

Figure 1
(Standard coupling nut)

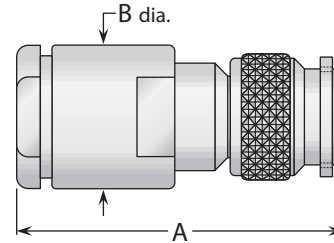

Figure 2
(Safety-wire holes in coupling nut)

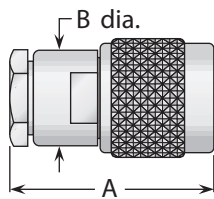

Figure 3
(Standard coupling nut)

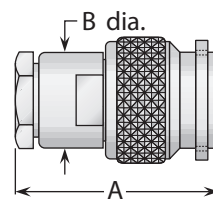
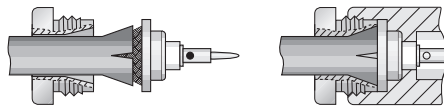

Figure 4
(Safety-wire holes in coupling nut)

Cable Group	Figure	Dimensions		Plating		Delta P/N	Assembly Procedure/ Trim Code
		A	B	Body	Contact		
1	1	1.66	.750	Nickel	Gold	1201001N000-000	A/01
2, 3	1	1.66	.750	Nickel	Gold	1201004N000-000	A/01
2, 3	1	1.66	.750	Nickel	Gold (C)	1201004N001-004	A/01
2, 3	2	1.66	.750	Nickel	Gold	1240004N000-000	A/01
2, 3	2	1.66	.750	Nickel	Gold (C)	1240004N001-000	A/01
5, 6	3	1.09	.500	Nickel	Gold	1201015N000-000	A/17
5, 6	3	1.09	.500	Nickel	Gold (C)	1201015N001-000	A/17
5, 6	4	1.09	.500	Nickel	Gold	1240015N000-000	A/17
5, 6	4	1.09	.500	Nickel	Gold (C)	1240015N001-000	A/17
7	3	1.09	.500	Nickel	Gold	1201021N000-000	A/17
7	3	1.09	.500	Nickel	Gold (C)	1201021N001-000	A/17
7	4	1.09	.500	Nickel	Gold	1240021N000-000	A/17
7	4	1.09	.500	Nickel	Gold (C)	1240021N001-000	A/17
8A	3	1.09	.500	Nickel	Gold	1201029N000-000	A/17
8A	3	1.09	.500	Nickel	Gold (C)	1201029N001-000	A/17
8B	3	1.09	.500	Nickel	Gold	1201043N000-000	A/17
8B	3	1.09	.500	Nickel	Gold (C)	1201043N001-000	A/17
9	3	1.09	.500	Nickel	Gold	1201036N000-000	A/18
9	3	1.09	.500	Nickel	Gold (C)	1201036N001-002	A/18
9	4	1.09	.500	Nickel	Gold	1240036N000-000	A/18
9	4	1.09	.500	Nickel	Gold (C)	1240036N001-000	A/18
11	3	1.09	.500	Nickel	Gold	1201038N000-000	A/18
11	3	1.09	.500	Nickel	Gold (C)	1201038N001-000	A/18

• See page 209 for cable groups. • Assembly procedures start on page 210.
• (C) in contact plating column indicates captive contact. • See page 6 for alternate body plating information.

Straight Plug - Heli-Grip® For Flexible Cable



Heli-Grip® Cable Attachment

These connectors have captivated contacts and allow rapid, easy assembly—simply trim the cable, slide into the cone/insulator/contact assembly (left), solder the center conductor to the contact, and screw body assembly (right) onto the cable assembly.

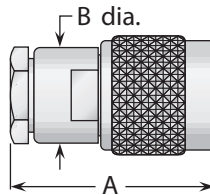

Figure 1

Cable Group	Figure	Dimensions		Plating		Delta P/N	Assembly Procedure/ Trim Code
		A	B	Body	Contact		
5, 6 [§]	1	1.09	.500	Nickel	Silver (C)	1201018N005-000	E/03
RG-223	1	1.09	.500	Nickel	Silver (C)	1201015N005-000	E/03
7	1	1.09	.500	Nickel	Silver (C)	1201019N005-000	E/03
8A	1	1.09	.500	Nickel	Silver (C)	1201029N005-000	E/03
8B	1	1.09	.500	Nickel	Silver (C)	1201043N005-000	E/03
9	1	1.09	.500	Nickel	Silver (C)	1201037N005-000	E/03
10	1	1.09	.500	Nickel	Silver (C)	1201100N005-000	E/03
11	1	1.09	.500	Nickel	Silver (C)	1201038N005-000	E/03

[§]Except RG-223/U.

Straight Plug - Crimp Type For Flexible Cable

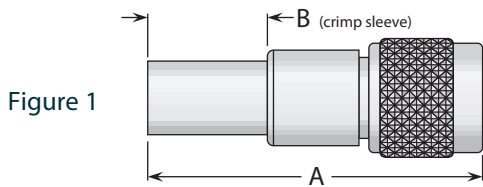

Figure 1

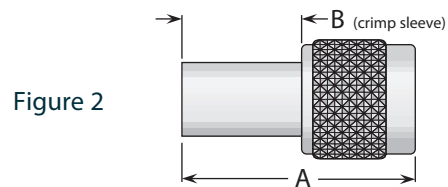

Figure 2

See page 198 for MIL-PRF-39012 QPL version.

Cable Group	Figure	Dimensions		Plating		Delta P/N	Assembly Procedure/ Trim Code
		A	B	Body	Contact		
3A, 4	1	1.75	.630	Nickel	Gold	1203005N000-000	B/11
5	2	1.06	.500	Nickel	Gold	1203017N000-000	B/23
6	2	1.06	.500	Nickel	Gold	1203013N000-000	B/23
7	2	1.06	.500	Nickel	Gold	1203020N000-000	B/23
7	2	1.04	.500	Nickel	Silver	1203020N000-003 *	***
7	2	1.04	.500	Nickel	Gold	1203020N000-005 *	***
7	2	1.06	.500	Nickel	Gold (C)	1203020N001-003 *	***

* Crimp center contact.

- See page 209 for cable groups.
- Assembly procedures start on page 210.
- (C) in contact plating column indicates captive contact.
- See page 6 for alternate body plating information.
- ***Contact factory for cable assembly instructions.

Straight Plug - Solder Clamp For Semi-Rigid Cable

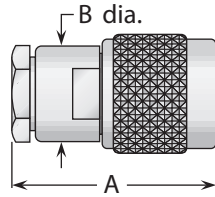

Figure 1
(Standard coupling nut)

See page 198 for
MIL-PRF-39012
QPL version.

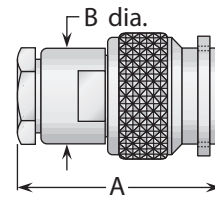

Figure 2
(Safety-wire holes in coupling nut)

Cable Group	Figure	Dimensions		Plating		Delta P/N	Assembly Procedure/ Trim Code
		A	B	Body	Contact		
13	1	1.09	.500	Nickel*	Gold	1201031N003-000	F/08
13	2	1.09	.500	Nickel*	Gold	1240031N003-000	F/08
14	1	1.09	.500	Nickel*	Gold	1201025N003-000	F/07
14	2	1.09	.500	Nickel*	Gold	1240025N003-000	F/07

* Solder ferrule is gold plated.

Right Angle Plug - Military Clamp For Flexible Cable

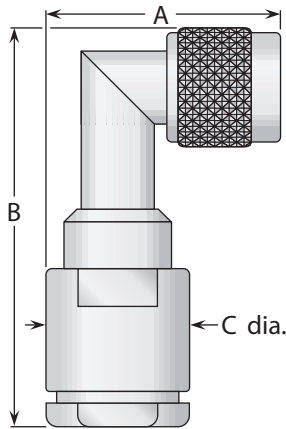

Figure 1

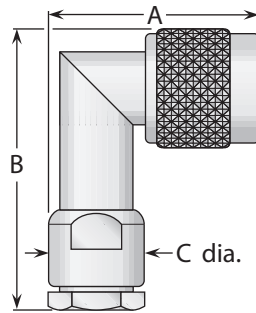

Figure 2

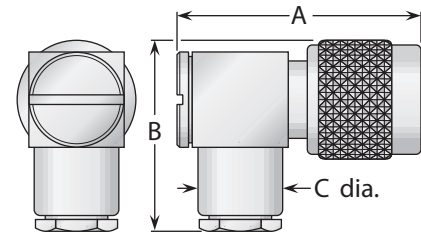
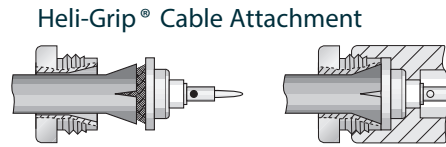
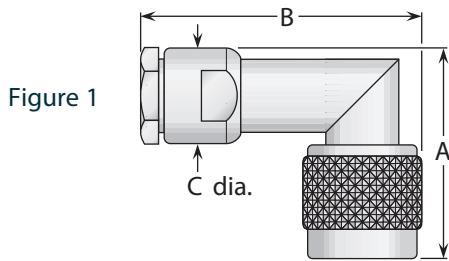

Figure 3

Cable Group	Figure	Dimensions			Plating		Delta P/N	Assembly Procedure/ Trim Code
		A	B	C	Body	Contact		
1	1	1.19	1.94	.750	Nickel	Gold	1204001N000-000	A/07
2, 3	1	1.19	1.94	.750	Nickel	Gold	1204004N000-000	A/07
2, 3	1	1.19	1.94	.750	Nickel	Gold (C)	1204004N001-000	A/07
5, 6	2	1.06	1.65	.500	Nickel	Gold	1204015N000-000	A/17
5, 6	2	1.06	1.65	.500	Nickel	Gold (C)	1204015N001-000	A/17
5, 6	3	1.20	1.11	.500	Nickel	Gold (C)	1205018N000-000	A/19
7	2	1.06	1.65	.500	Nickel	Gold	1204021N000-000	A/17
7	2	1.06	1.65	.500	Nickel	Gold (C)	1204021N001-000	A/17
7	3	1.20	1.11	.500	Nickel	Gold (C)	1205021N000-000	A/19
8A	3	1.20	1.11	.500	Nickel	Gold (C)	1205029N000-000	A/19
9	2	1.06	1.65	.500	Nickel	Gold	1204036N000-000	A/18
9	3	1.20	1.11	.500	Nickel	Gold (C)	1205036N000-001	A/19

- See page 209 for cable groups.
- Assembly procedures start on page 210.
- (C) in contact plating column indicates captive contact.
- See page 6 for alternate body plating information.

Right Angle Plug - Heli-Grip® For Flexible Cable



These connectors have captivated contacts and allow rapid, easy assembly—simply trim the cable, slide into the cone/insulator/contact assembly (left), solder the center conductor to the contact, and screw body assembly (right) onto cable assembly.

Cable Group	Figure	Dimensions			Plating		Delta P/N	Assembly Procedure/Trim Code
		A	B	C	Body	Contact		
5, 6 [§]	1	1.06	1.65	.500	Nickel	Silver (C)	1204018N005-000	E/03
RG-223	1	1.06	1.65	.500	Nickel	Silver (C)	1204015N005-000	E/03
7	1	1.06	1.65	.500	Nickel	Silver (C)	1204019N005-000	E/03
8A	1	1.06	1.65	.500	Nickel	Silver (C)	1204029N005-000	E/03
8B	1	1.06	1.65	.500	Nickel	Silver (C)	1204043N005-000	E/03
9	1	1.06	1.65	.500	Nickel	Silver (C)	1204037N005-000	E/03
10	1	1.06	1.65	.500	Nickel	Silver (C)	1204100N005-000	E/03
11	1	1.06	1.65	.500	Nickel	Silver (C)	1204038N005-000	E/03

[§]Except RG-223/U.

Right Angle Plug - Crimp Type For Flexible Cable

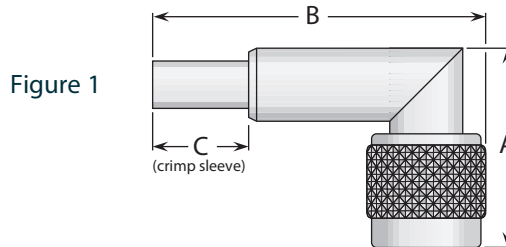

Cable Group	Figure	Dimensions			Plating		Delta P/N	Assembly Procedure/Trim Code
		A	B	C	Body	Contact		
5	1	1.03	1.72	.500	Nickel	Gold	1207017N000-000	B/02
6	1	1.03	1.72	.500	Nickel	Gold	1207015N000-000	B/02
7	1	1.03	1.72	.500	Nickel	Gold	1207020N000-000	B/02

Right Angle Plug - Solder-Clamp For Semi-Rigid Cable

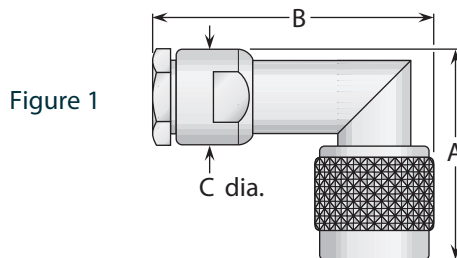

* Solder ferrule is gold plated.

Cable Group	Figure	Dimensions			Plating		Delta P/N	Assembly Procedure/Trim Code
		A	B	C	Body	Contact		
13	1	1.06	1.65	.500	Nickel*	Gold	1204031N003-000	F/08
14	1	1.06	1.65	.500	Nickel*	Gold	1204025N003-000	F/07

* Solder Ferrule Is Gold Plated

- See page 209 for cable groups.
- Assembly procedures start on page 210.
- (C) in contact plating column indicates captive contact.
- See page 6 for alternate body plating information.

Straight Jacks - For Flexible & Semi-Rigid Cable

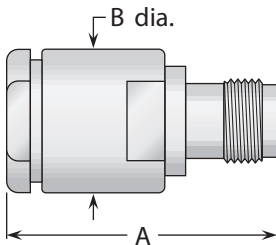

Figure 1

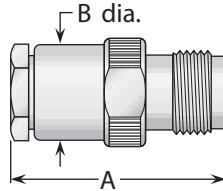

Figure 2

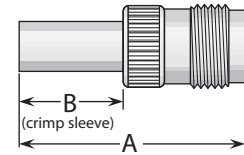
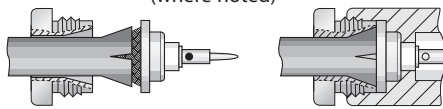

Figure 3

See page 199 for MIL-PRF-39012 QPL versions.

Heli-Grip® Cable Attachment (where noted)



These connectors have captivated contacts and allow rapid, easy assembly—simply trim the cable, slide into the cone/insulator/contact assembly (left), solder the center conductor to the contact, and screw body assembly (right) onto the cable assembly.

Military Clamp for Flexible Cable

Cable Group	Figure	Dimensions		Plating		Delta P/N	Assembly Procedure/ Trim Code
		A	B	Body	Contact		
1	1	1.75	.750	Nickel	Gold	1208001N000-000	A/20
2, 3	1	1.75	.750	Nickel	Gold	1208004N000-000	A/20
5, 6	2	1.16	.500	Nickel	Gold	1208015N000-000	A/17
5, 6	2	1.16	.500	Nickel	Gold (C)	1208015N001-000	A/17
7	2	1.16	.500	Nickel	Gold	1208021N000-000	A/17
7	2	1.16	.500	Nickel	Gold (C)	1208021N001-000	A/17
9	2	1.16	.500	Nickel	Gold	1208036N000-000	A/18
9	2	1.16	.500	Nickel	Gold (C)	1208036N001-000	A/18
11	2	1.16	.500	Nickel	Gold	1208038N000-000	A/18

Heli-Grip for Flexible Cable

5, 6 [§]	2	1.16	.500	Nickel	Silver (C)	1208018N005-001	E/03
RG-223	2	1.16	.500	Nickel	Silver (C)	1208015N005-000	E/03
7	2	1.16	.500	Nickel	Silver (C)	1208019N005-000	E/03
8A	2	1.16	.500	Nickel	Silver (C)	1208029N005-000	E/03
8B	2	1.16	.500	Nickel	Silver (C)	1208043N005-000	E/03
9	2	1.16	.500	Nickel	Silver (C)	1208037N005-000	E/03
10	2	1.16	.500	Nickel	Silver (C)	1208100N005-000	E/03
11	2	1.16	.500	Nickel	Silver (C)	1208038N005-000	E/03

Crimp Type for Flexible Cable

5	3	1.16	.500	Nickel	Gold	1210017N000-000	B/05
6	3	1.16	.500	Nickel	Gold	1210013N000-000	B/05
7	3	1.16	.500	Nickel	Gold	1210020N000-000	B/05
7	3	1.06	.410	Nickel	Silver	1210020N001-000**	***

Solder-Clamp for Semi-Rigid Cable

13	2	1.16	.500	Nickel*	Gold	1208031N003-000	F/08
14	2	1.16	.500	Nickel*	Gold	1208025N003-000	F/07

[§]Except RG-223/U.

*Solder ferrule is gold plated.

- See page 209 for cable groups.
- Assembly procedures start on page 210.
- (C) in contact plating column indicates captive contact.
- See page 6 for alternate body plating information.
- **Indicates crimp center contact.
- ***Contact factory for cable assembly instructions.

Bulkhead Jacks - For Flexible & Semi-Rigid Cable

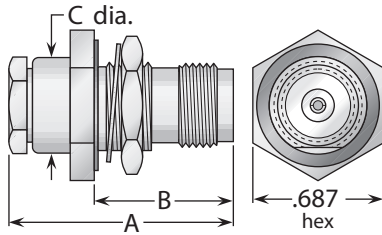

Figure 1
(Rear mount)

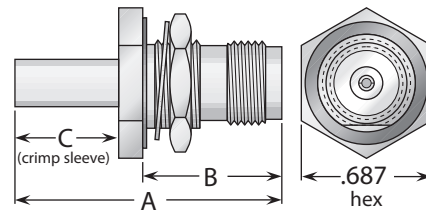
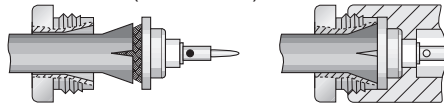

Figure 2
(Rear mount)

See page 199 for MIL-PRF-39012 QPL versions.

Heli-Grip® Cable Attachment (where noted)



These connectors have captivated contacts and allow rapid, easy assembly—simply trim the cable, slide into the cone/insulator/contact assembly (left), solder the center conductor to the contact, and screw body assembly (right) onto the cable assembly.

Military Clamp for Flexible Cable

Cable Group	Fig.	Dimensions			Mounting Figure	Max. Panel	Plating		Delta P/N	Assembly Procedure/Trim Code
		A	B	C			Body	Contact		
5, 6	1	1.16	.680	.500	59	.110	Nickel	Gold	1216015N590-000	A/17
5, 6	1	1.16	.680	.500	59	.110	Nickel	Gold (C)	1216015N591-000	A/17
5, 6	1	1.16	.810	.500	59	.240	Nickel	Gold (C)	1216015N59E-000	A/17
7	1	1.16	.680	.500	59	.110	Nickel	Gold	1216021N590-002	A/17
7	1	1.16	.680	.500	59	.110	Nickel	Gold (C)	1216021N591-000	A/17
7	1	1.16	.810	.500	59	.240	Nickel	Gold (C)	1216021N59E-000	A/17
9	1	1.16	.680	.500	59	.110	Nickel	Gold	1216036N590-000	A/17
9	1	1.16	.680	.500	59	.110	Nickel	Gold (C)	1216036N591-005	A/18
11	1	1.16	.680	.500	59	.110	Nickel	Gold	1216038N590-002	A/18
11	1	1.16	.680	.500	59	.110	Nickel	Gold (C)	1216038N591-001	A/18

Heli-Grip for Flexible Cable

5, 6 [§]	1	1.16	.810	.500	59	.240	Nickel	Silver (C)	1216018N595-000	E/03
RG-223	1	1.16	.810	.500	59	.240	Nickel	Silver (C)	1216015N595-001	E/03
7	1	1.16	.810	.500	59	.240	Nickel	Silver (C)	1216019N595-000	E/03
8A	1	1.16	.810	.500	59	.240	Nickel	Silver (C)	1216029N595-000	E/03
8B	1	1.16	.810	.500	59	.240	Nickel	Silver (C)	1216043N595-000	E/03
9	1	1.16	.810	.500	59	.240	Nickel	Silver (C)	1216037N595-000	E/03
10	1	1.16	.810	.500	59	.240	Nickel	Silver (C)	1216100N595-002	E/03
11	1	1.16	.810	.500	59	.240	Nickel	Silver (C)	1216038N595-000	E/03

Crimp Type for Flexible Cable

5	2	1.31	.680	.500	59	.110	Nickel	Gold	1219017N590-000	B/13
6	2	1.31	.680	.500	59	.110	Nickel	Gold	1219013N590-002	B/13
7	2	1.31	.680	.500	59	.110	Nickel	Gold	1219020N590-000	B/13

Solder-Clamp for Semi-Rigid Cable

13	1	1.16	.680	.500	59	.110	Nickel*	Gold	1216031N593-000	F/08
14	1	1.16	.680	.500	59	.110	Nickel*	Gold	1216025N593-000	F/07

[§]Except RG-223/U.

* Solder ferrule is gold plated.

- See page 209 for cable groups.
- Assembly procedures start on page 210.
- See page 208 for mounting dimensions.
- (C) in contact plating column indicates captive contact.
- See page 6 for alternate body plating information.

Bulkhead Jacks - For Flexible & Semi-Rigid Cable

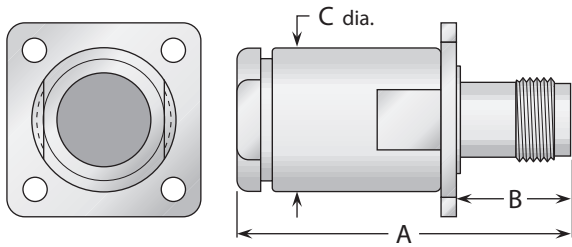

Figure 1

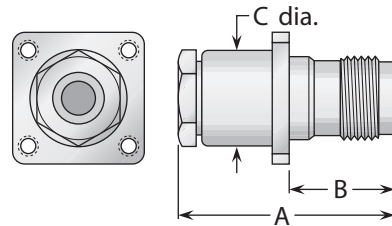
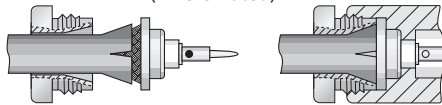

Figure 2

See page 200 for MIL-PRF-39012 QPL version.

Heli-Grip® Cable Attachment (where noted)



These connectors have captivated contacts and allow rapid, easy assembly—simply trim the cable, slide into the cone/insulator/contact assembly (left), solder the center conductor to the contact, and screw body assembly (right) onto the cable assembly.

Cable Group	Fig.	Dimensions			Mounting Figure	Plating		Delta P/N	Assembly Procedure/Trim Code
		A	B	C		Body	Contact		
Military Clamp for Flexible Cable									
1	1	1.75	.630	.750	33	Nickel	Gold	1211001N330-000	A/20
2, 3	1	1.75	.630	.750	33	Nickel	Gold	1211004N330-000	A/20
5, 6	2	1.16	.550	.500	07	Nickel	Gold	1211015N070-000	A/17
5, 6	2	1.16	.550	.500	07	Nickel	Gold (C)	1211015N071-000	A/17
7	2	1.16	.550	.500	07	Nickel	Gold	1211021N070-000	A/17
7	2	1.16	.550	.500	07	Nickel	Gold (C)	1211021N071-000	A/17
9	2	1.16	.550	.500	07	Nickel	Gold	1211036N070-000	A/18
9	2	1.16	.550	.500	07	Nickel	Gold (C)	1211036N071-000	A/18
11	2	1.16	.550	.500	07	Nickel	Gold	1211038N070-000	A/18
Heli-Grip for Flexible Cable									
5, 6 [§]	1	1.16	.550	.500	07	Nickel	Silver (C)	1211018N075-001	E/03
RG-223	1	1.16	.550	.500	07	Nickel	Silver (C)	1211015N075-000	E/03
7	1	1.16	.550	.500	07	Nickel	Silver (C)	1211019N075-000	E/03
8A	1	1.16	.550	.500	07	Nickel	Silver (C)	1211029N075-000	E/03
8B	1	1.16	.550	.500	07	Nickel	Silver (C)	1211043N075-000	E/03
9	1	1.16	.550	.500	07	Nickel	Silver (C)	1211037N075-000	E/03
10	1	1.16	.550	.500	07	Nickel	Silver (C)	1211100N075-000	E/03
11	1	1.16	.550	.500	07	Nickel	Silver (C)	1211038N075-000	E/03
Solder-Clamp for Semi-Rigid Cable									
13	1	1.16	.550	.500	07	Nickel*	Gold	1211031N073-000	F/08
14	1	1.16	.550	.500	07	Nickel*	Gold	1211025N073-000	F/07

[§]Except RG-223/U.

* Solder ferrule is gold plated.

- See page 209 for cable groups.
- Assembly procedures start on page 210.
- See page 208 for mounting dimensions.
- (C) in contact plating column indicates captive contact.
- See page 6 for alternate body plating information.

Panel Jack Receptacles - Square Flange

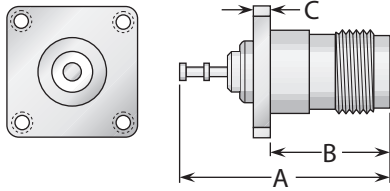

Figure 1
(Turret contact)

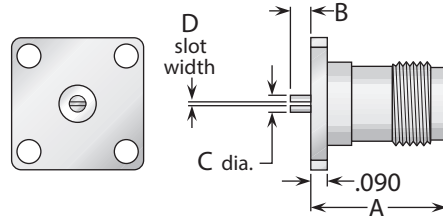

Figure 2
(Slotted contact)

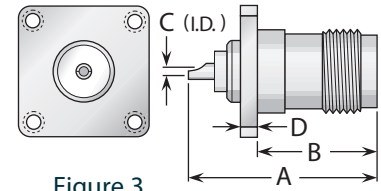

Figure 3
(Solder pot contact)

See page 201 for MIL-PRF-39012 QPL version.

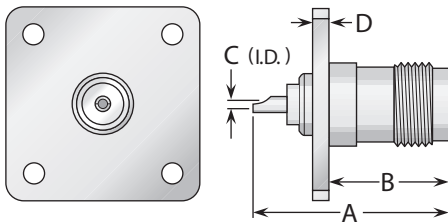

Figure 4
(Solder pot contact, 1" square flange, interchangeable with type N standard flange size)

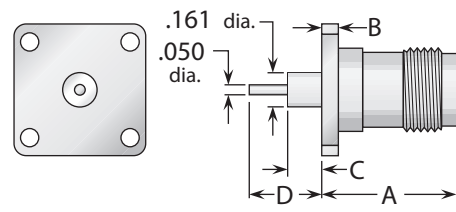

Figure 5
(Post contact)

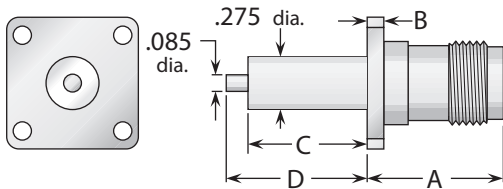

Figure 6
(Post contact)

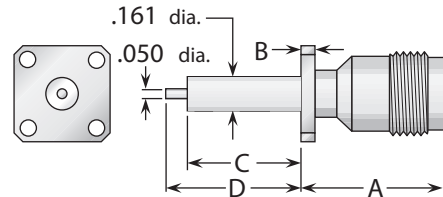

Figure 7
(Post contact, 1/2" square flange, interchangeable with SMA standard flange size)

Figure	Dimensions				Mounting Figure	Plating		Delta P/N
	A	B	C	D		Body	Contact	
1	1.06	.630	.090	—	07	Nickel	Silver (C)	1212000N070-000
2	.715	.050	.085	.012/.017	09	Nickel	Gold (C)*	1243000F09E-001
2	.715	.050	.085	.036/.040	09	Nickel	Gold (C)*	1243000F09E-002
3	1.06	.630	.062	.090	07	Nickel	Gold (C)	1213000N071-000
3	1.06	.630	.062	.090	08	Nickel	Gold (C)	1213000N080-000
3	1.06	.630	.062	.090	09	Nickel	Gold (C)	1213000N090-000
3	1.06	.630	.062	.090	18	Nickel	Gold (C)	1213000N180-000
4	1.06	.630	.062	.080	33	Nickel	Gold (C)	1213000N330-000
5	.715	.090	.175	.375	09	Nickel	Gold (C)	1258000N091-009
6	.750	.080	.000	1.25	18	Nickel	Gold (C)	1258000N181-000
6	.750	.080	.590	.705	18 ^s	Nickel	Gold (C)*	1258000N181-009
7	.750	.080	.590	.705	05	Nickel	Gold (C)	1258000N051-000

- (C) in contact plating column indicates captive contact. • *Indicates epoxy-captivated contact.
- ^sFlange #18 except with .125 dia. mounting holes. • See page 6 for alternate body plating information.
- See page 208 for mounting dimensions. • All items are available with other flange sizes and contact configurations.

Right Angle & Panel Jack Receptacles - Square Flange

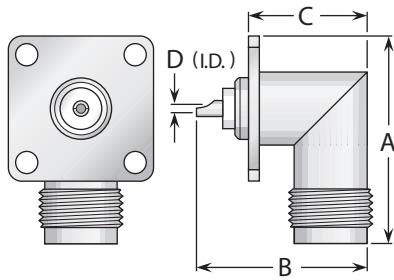

Figure 1
(Solder pot contact)

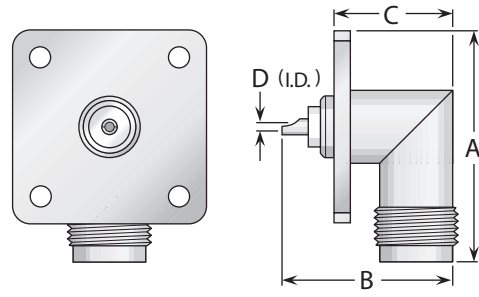

Figure 2
(Solder pot contact, 1" square flange, interchangeable with type N standard flange size)

Figure	Dimensions				Mounting Figure	Plating		Delta P/N
	A	B	C	D		Body	Contact	
1	1.06	.910	.650	.062	07	Nickel	Gold (C)	1215000N070-000
1	1.06	.910	.650	.062	08	Nickel	Gold (C)	1215000N080-000
1	1.09	.910	.610	.062	18	Nickel	Gold (C)	1215000N180-000
2	1.22	.910	.650	.062	33	Nickel	Gold (C)	1215000N330-000

Panel Plug Receptacles - Square Flange

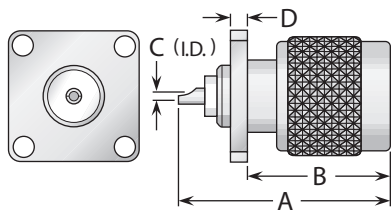

Figure 1
(Solder pot contact, 3/4" square flange)

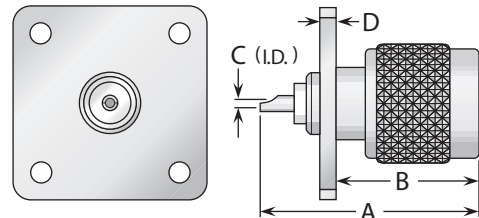

Figure 2
(Solder pot contact, 1" square flange, interchangeable with type N standard flange size)

Figure 3
(Slotted contact, 11/16" square flange)

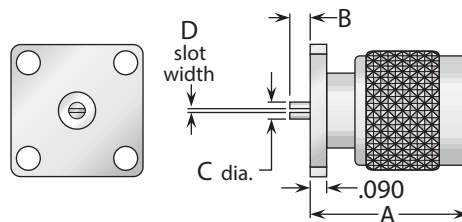

Figure	Dimensions				Mounting Figure	Plating		Delta P/N
	A	B	C	D		Body	Contact	
1	1.16	.740	.062	.090	18	Nickel	Gold (C)	1223000N180-000
2	1.16	.740	.062	.080	33	Nickel	Gold (C)	1223000N330-000
3	.830	.050	.083	.012/.017	09	Nickel	Gold (C)	1259000N091-001
3	.830	.050	.083	.030	09	Nickel	Gold (C)	1259000N091-002
3	.830	.050	.083	.040	09	Nickel	Gold (C)	1259000N091-003

- (C) in contact plating column indicates captive contact.
- See page 6 for alternate body plating information.
- See page 208 for mounting dimensions.
- All items are available with other flange sizes and contact configurations.

Bulkhead Jack Receptacles

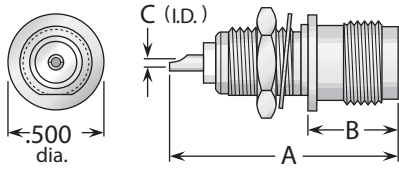

Figure 1
(Front mount)

See page 200 for MIL-PRF-39012 QPL version.

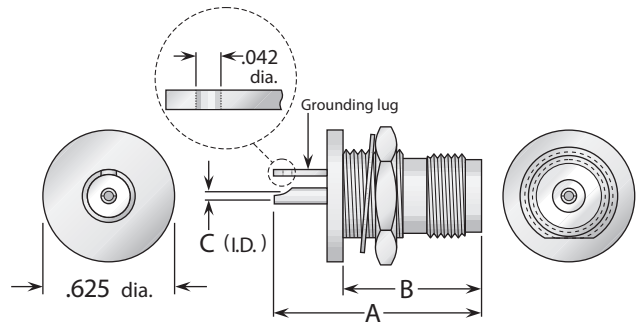

Figure 2
(Rear mount, with grounding lug)

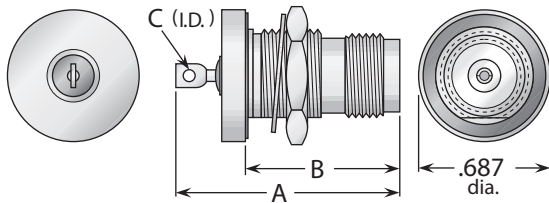

Figure 3
(Rear mount, hermetically sealed,
with mounting gasket)

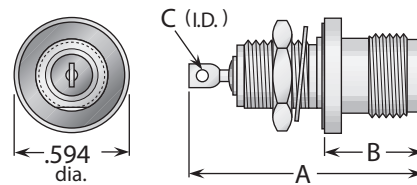

Figure 4
(Front mount, hermetically sealed,
with mounting gasket)

Figure 5
(Right angle, with mounting gasket)

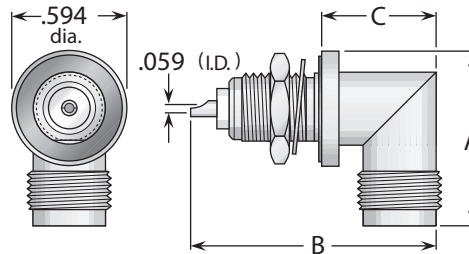
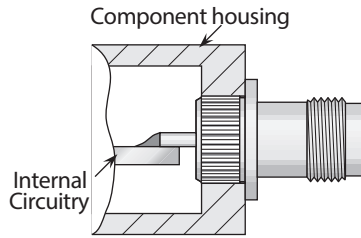

Figure	Dimensions			Max. Panel	Mounting Figure	Plating		Delta P/N
	A	B	C			Body	Contact	
1	1.06	.470	.062	.130	62	Nickel	Gold (C)	1220000N620-000
1	1.19	.470	.062	.260	62	Nickel	Gold (C)	1220000N62E-001
1	1.06	.470	.062	.130	65	Nickel	Gold (C)	1220000N650-000
1	1.06	.470	.062	.190	65	Nickel	Silver (C)	1220000N656-000
1	1.06	.470	.062	.190	65	Nickel	Gold (C)	1220000N65E-000
1	1.19	.470	.062	.260	65	Nickel	Gold (C)	1220000N65G-000
2	1.06	.750	.062	.160	59	Nickel	Gold (C)	1221000N591-003
3	1.20	.830	.062	.260	59	Nickel	Gold (C)	1221000N598-000
4	1.20	.520	.062	.260	65	Nickel	Gold (C)	1220000N638-000
5	.970	1.22	.590	.130	65	Nickel	Gold (C)	1222000N630-001
5	.970	1.34	.590	.250	65	Nickel	Gold (C)	1222000N630-002

(C) in contact plating column indicates captive contact. • See page 208 for mounting dimensions.
See page 6 for alternate body plating information. • All items are available with other flange sizes and contact configurations.

Press Mount Receptacles



Delta Press Mount Receptacles

These connectors eliminate the need for complicated mounting hole patterns and mounting hardware.

They are simply pressed into a single through hole, and the precisely-engineered knurled mounting section provides retention strength far greater than normal mating and unmating forces. An integral shoulder provides a positive stop when mounting.

PressMounts are available for a wide variety of Delta connector series, and can be used in packages as small as the outer diameter of the connector body.

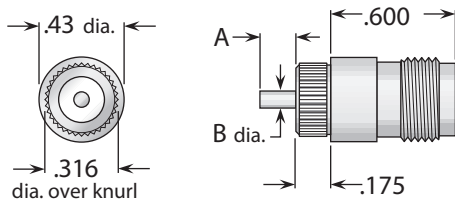

Figure 1
(Post contact)

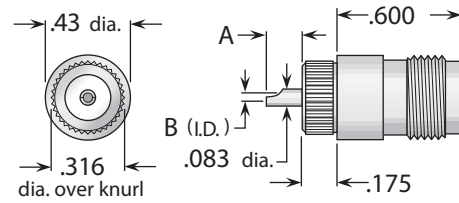

Figure 2
(Solder pot contact)

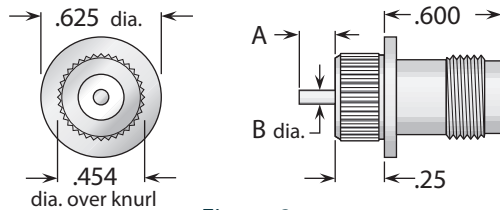

Figure 3
(Post contact)

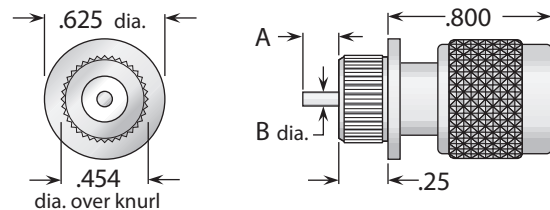

Figure 4
(Plug type, post contact)

Figure	Dimensions		Min. Panel	Mounting Hole	Plating		Delta P/N
	A	B			Body	Contact	
1	.062	.050	.150	.312 ±.001 dia.	Nickel	Gold (C)	1220000N911-002
2	.285	.062	.150	.312 ±.001 dia.	Nickel	Gold (C)	1220000N911-003
3	.060	.050	.200	.450 ±.001 dia.	Nickel	Gold (C)	1220000N911-005
4	.060	.050	.200	.450 ±.001 dia.	Nickel	Gold (C)	1224000N911-002

Stripline Receptacles

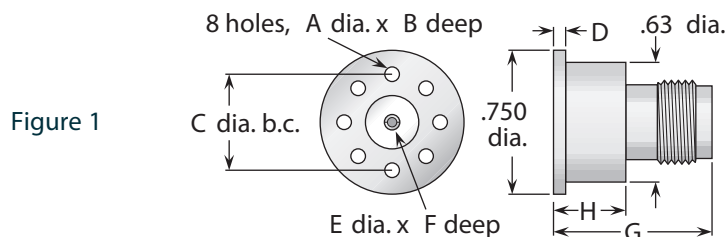

Figure 1

Figure	Dimensions								Plating		Delta P/N
	A	B	C	D	E	F	G	H	Body	Contact	
1	.078	.310	.500	.063	.063	.220	.828	.375	Nickel	Gold (C)	1256000N000-002
1	#2-56	.250	.500	.063	.063	.220	.828	.375	Nickel	Gold (C)	1256000N000-003

- (C) in contact plating column indicates captive contact.
- See page 6 for alternate body plating information.
- All items are available with other flange sizes and contact configurations.

Resistive Termination (Plug Type)

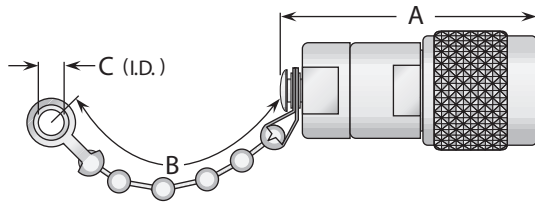

Figure 1

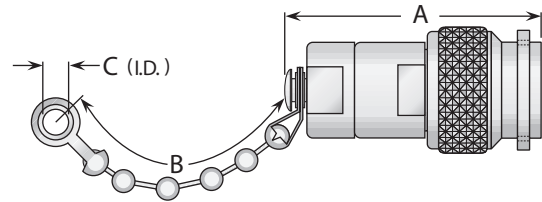

Figure 2

(Safety-wire holes in coupling nut)

Resistor	Fig.	Dimensions			Features	Plating		Delta P/N
		A	B	C		Body	Contact	
51 Ω ±5%, 1/2 Watt	1	1.25	3.50	.144	Bead chain	Nickel	Gold (C)	1231000N000-000
51 Ω ±5%, 1/2 Watt	1	1.25	—	—	No chain	Nickel	Gold (C)	1231000N00A-000
75 Ω ±1%, 1/2 Watt	2	1.25	3.50	.144	Bead chain	Nickel	Gold (C)	1231000N000-005
75 Ω ±1%, 1/2 Watt	1	1.25	—	—	No chain	Nickel	Gold (C)	1231000N00A-002

Dust Caps

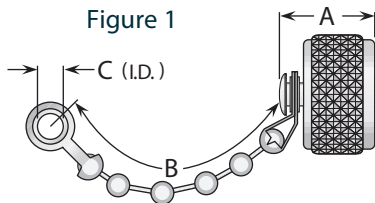

Figure 1

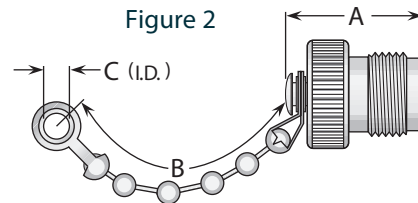
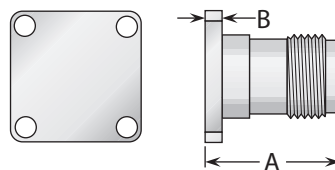

Figure 2

Figure	Dimensions			Features	Plating		Delta P/N
	A	B	C		Body	Contact	
1	.530	2.25	.144	Bead chain	Nickel	—	1232000N000-000
1	.370	—	—	No chain	Nickel	—	1232000N00A-000
1	.690	2.25	.144	Bead chain / shorting type	Nickel	Gold (C)	1232000N00C-000
2	.580	3.50	.144	Bead chain	Nickel	—	1233000N000-002
2	.580	—	—	No chain	Nickel	—	1233000N00A-000
2	.690	2.50	.144	Bead chain / shorting type	Nickel	Gold (C)	1233000N00C-000

Dummy Receptacle



Dimensions		Mounting Figure	Plating		Delta P/N
A	B		Body	Contact	
.715	.080	09	Nickel	—	1263000N090-000

- (C) in contact plating column indicates captive contact.
- See page 6 for alternate body plating information.
- See page 203 for mounting dimensions.
- Caps and terminations are available with other chain styles and/or resistances.

Keying Baskets - For Polarization Of Mated Pairs

Multiple Polarizations in a Single Installation

In applications with multiple connector pairs, these keying baskets polarize individual jacks so they can only be mated with plugs that have coupling nuts modified with the correct groove orientation.

The grooves in the plug coupling nuts engage the keying bars in the basket, making it impossible to mismate pairs, even by force.

The keying baskets can be used with any TNC jack—they slide over the jack's mating threads and are secured with a Truarc retaining ring. Any Delta TNC plug can be supplied with a grooved coupling nut to match any keying basket.

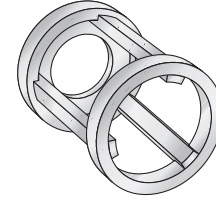

Application Example

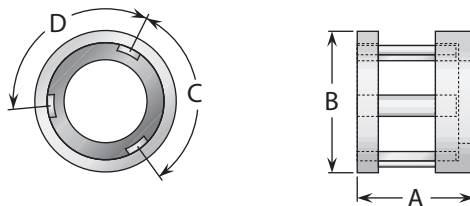
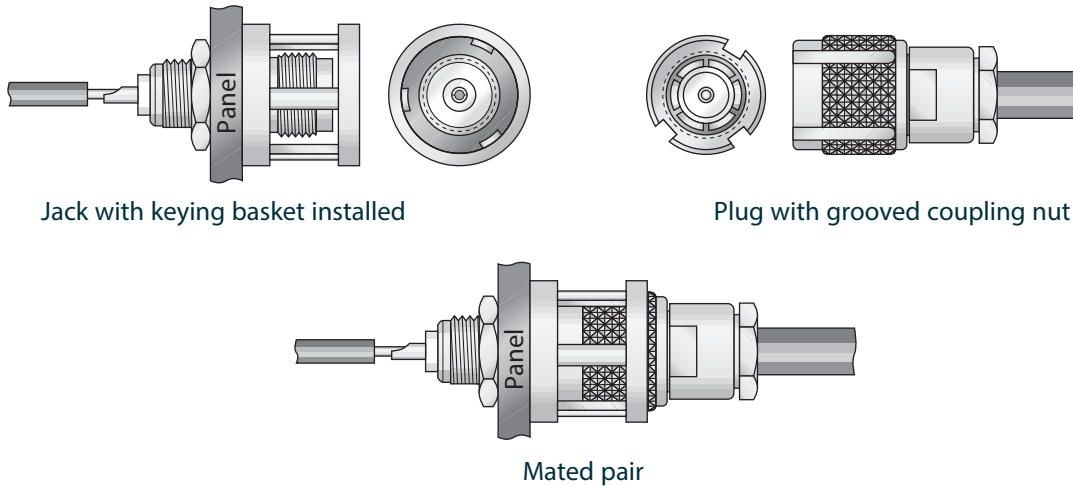

Figure 1

Figure	Dimensions				Plating	Delta P/N
	A	B	C	D		
1	.430	.730	72°	120°	Silver	1261000A00M-001
1	.430	.730	96°	96°	Silver	1261000A00M-002
1	.430	.730	120°	144°	Silver	1261000A00M-003
1	.430	.730	72°	144°	Silver	1261000A00M-004
1	.430	.730	120°	120°	Silver	1261000A00M-005
1	.430	.730	120°	72°	Silver	1261000A00M-006

See page 6 for alternate body plating information.

Bulkhead & Panel Mounted Jack-Jack Adapters (Connect Two Plugs)

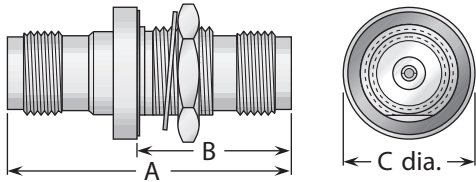

Figure 1
(Bulkhead mount)

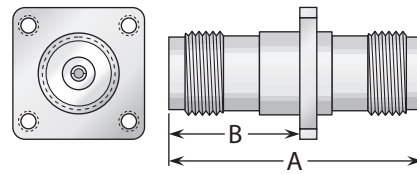

Figure 2
(Panel mount)

Figure	Dimensions			Max. Panel	Mounting Figure	Plating		Delta P/N
	A	B	C			Body	Contact	
1	1.28	.800	.625	.160	59	Nickel	Gold (C)	1226000N591-001
1	1.39	.760	.690	.190	59	Nickel	Gold (C)	1226000N598-002 *
2	1.28	.690	—	—	07	Nickel	Silver (C)	1225000N070-001

* Hermetically sealed, with mounting gasket.

Straight Adapters

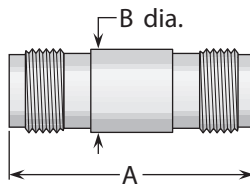

Figure 1
(Straight jack-jack;
connects two plugs)

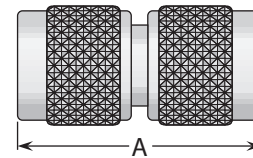

Figure 2
(Straight plug-plug;
connects two jacks)

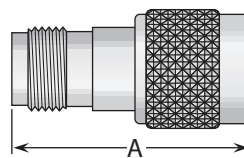

Figure 3
(Straight jack-plug;
connects one plug and one jack)

Figure	Dimensions		Plating		Delta P/N
	A	B	Body	Contact	
1	1.28	.440	Nickel	Silver (C)	1228000N000-000
2	1.25	—	Nickel	Gold (C)	1227000N000-000
3	1.22	—	Nickel	Gold (C)	1234000N000-000

(C) in contact plating column indicates captive contact. • See page 6 for alternate body plating information.
See page 208 for mounting dimensions.

Right Angle Adapters

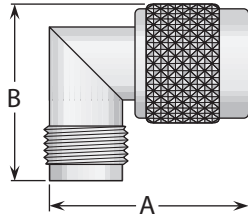

Figure 1
(Right angle plug-jack;
connects one plug and one jack)

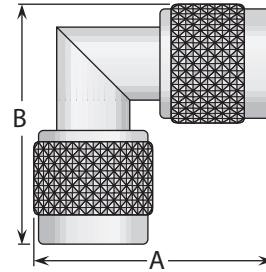

Figure 2
(Right angle plug-plug;
connects two jacks)

Figure	Dimensions		Plating		Delta P/N
	A	B	Body	Contact	
1	1.03	.950	Nickel	Gold (C)	1229000N000-000
2	1.25	1.25	Nickel	Gold (C)	1241000N000-000

Tee Adapters

Figure 1
(Tee jack-jack-jack;
connects three plugs)

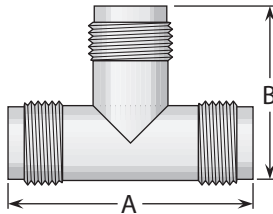

Figure 2
(Tee jack-plug-jack;
connects two plugs
and one jack)

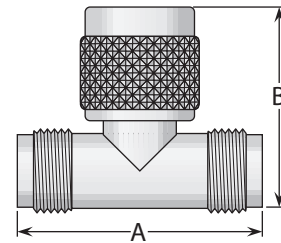

Figure 3
(Tee plug-jack-plug;
connects two jacks
and one plug)

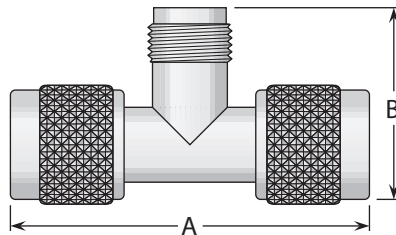

Figure 4
(Tee jack-jack-plug;
connects two plugs
and one jack)

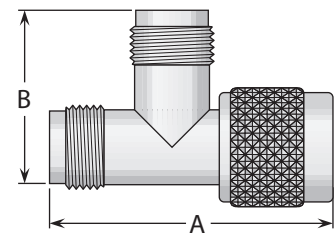

Figure	Dimensions		Plating		Delta P/N
	A	B	Body	Contact	
1	1.28	.880	Nickel	Gold (C)	1238000N000-000
2	1.28	1.03	Nickel	Gold (C)	1230000N000-000
3	1.88	.950	Nickel	Gold (C)	1242000N000-000
4	1.48	1.06	Nickel	Silver (C)	1249000N000-000

• (C) in contact plating column indicates captive contact.

• See page 6 for alternate body plating information.

Cable Plugs & Jacks

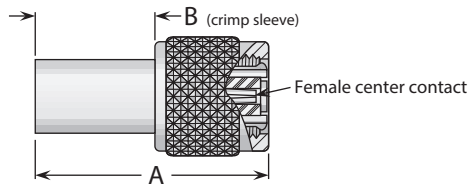

Figure 1
(Crimp type plug)

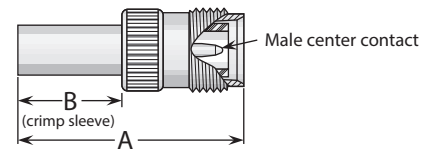

Figure 2
(Crimp type jack)

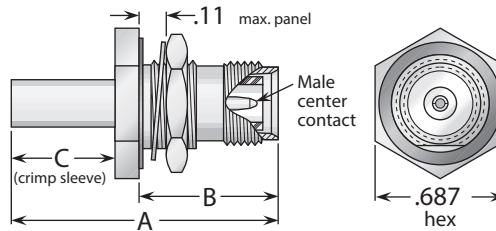

Figure 3
(Crimp type bulkhead jack)

Cable Group	Fig.	Dimensions			Mounting Figure	Plating		Delta P/N	Assembly Procedure/Trim Code
		A	B	C		Body	Contact		
5	1	1.06	.500	—	—	Nickel	Gold	1203017N002-000	B/23
5	2	1.16	.500	—	—	Nickel	Gold	1210017N002-000	B/05
5	3	1.31	.680	.500	59	Nickel	Gold	1219017N592-000	B/13
6	1	1.06	.500	—	—	Nickel	Gold	1203013N002-000	B/23
6	2	1.16	.500	—	—	Nickel	Gold	1210013N002-000	B/05
6	3	1.31	.680	.500	59	Nickel	Gold	1219013N592-000	B/13

Jack Receptacles

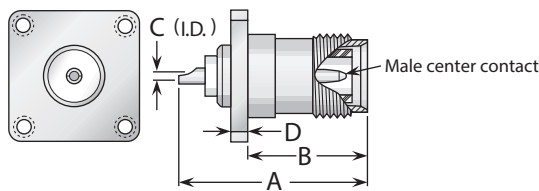

Figure 1
(Panel jack receptacle)

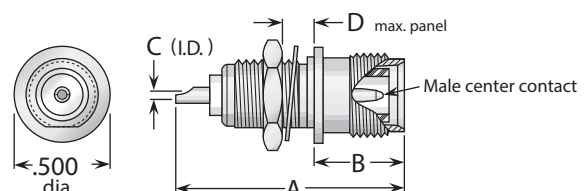

Figure 2
(Bulkhead jack receptacle)

Figure	Dimensions				Mounting Figure	Plating		Delta P/N
	A	B	C	D		Body	Contact	
1	1.06	.630	.062	.090	07	Nickel	Gold (C)	1213000N072-005
1	1.16	.630	.062	.090	09	Nickel	Gold (C)	1213000N092-000
2	1.06	.470	.062	.130	62	Nickel	Gold (C)	1220000N622-000
2	1.06	.470	.062	.190	65	Nickel	Gold (C)	1220000N652-001

- See page 209 for cable groups.
- Assembly procedures start on page 210.
- See page 208 for mounting dimensions.
- (C) in contact plating column indicates captive contact.
- See page 6 for alternate body plating information.

Assembly Procedure A

- 1) Trim cable jacket to dimension A.
Slide backnut, washer, V-gasket, and braid clamp onto cable as shown.
Cable jacket should bottom on step in braid clamp.

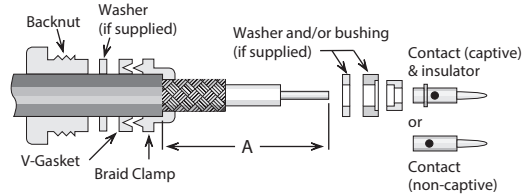

- 2) Comb braid wires out straight and fold back over front shoulder of braid clamp (braid wires should not overlap one another after folding). Trim braid wires flush with step of braid clamp. Trim cable dielectric and center conductor to dimensions B and C.

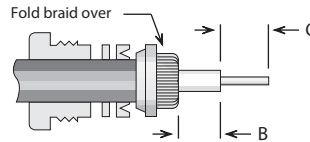

- 3) If support insulator is provided for RG-62 or 71 cable, insert into hollow in dielectric. Assemble rear bushing or washer (if supplied), rear insulator (if captive contact) and contact, and solder contact to center conductor. Rear of contact should be flush with cable dielectric end. For right angle connectors with access cap, omit this step entirely.

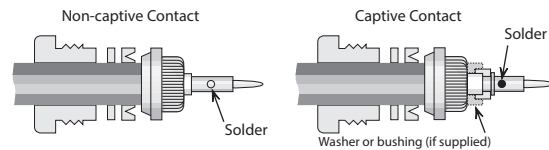

- 4) Insert prepared cable and hardware into body and tighten backnut. For right angle connectors with access cap, solder center conductor into slot in contact and tighten access cap.

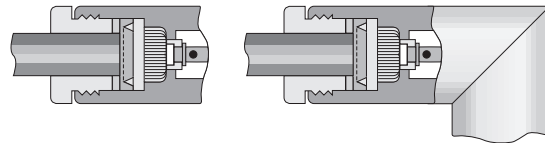

Trim Codes For Assembly Procedure A

Code	A	B	C	Code	A	B	C
A/01	.375 (3/8)	.047 (3/64)	.203 (13/64)	A/20	.375 (3/8)	.047 (3/64)	.172 (11/64)
A/02	.375 (3/8)	.109 (7/64)	.203 (13/64)	A/21	.500 (1/2)	.313 (5/16)	.172 (11/64)
A/03	.438 (7/16)	.250 (1/4)	.188 (3/16)	A/22	.375 (3/8)	.188 (3/16)	.141 (9/64)
A/04	.281 (9/32)	.047 (3/64)	.125 (1/8)	A/23	.438 (7/16)	.078 (5/64)	.172 (11/64)
A/05	.313 (5/16)	.125 (1/8)	.109 (7/64)	A/24	.500 (1/2)	.094 (3/32)	.141 (9/64)
A/06	.594 (19/32)	.391 (25/64)	.156 (5/32)	A/25	.438 (7/16)	.141 (9/64)	.172 (11/64)
A/07	.375 (3/8)	.047 (3/64)	.125 (1/8)	A/26	.625 (5/8)	.281 (9/32)	.250 (1/4)
A/08	.281 (9/32)	.109 (7/64)	.094 (3/32)	A/27	.688 (11/16)	.281 (9/32)	.125 (1/8)
A/09	.344 (11/32)	.109 (7/64)	.094 (3/32)	A/28	.656 (21/32)	.297 (19/64)	.250 (1/4)
A/10	.406 (13/32)	.109 (7/64)	.203 (13/64)	A/29	.688 (11/16)	.125 (1/8)	.313 (5/16)
A/11	.500 (1/2)	.281 (9/32)	.156 (5/32)	A/30	.688 (11/16)	.469 (15/32)	.156 (5/32)
A/12	.343	.040	.219	A/31	.700 (21/32)	.453 (29/64)	.250 (1/4)
A/13	.375 (3/8)	.125 (1/8)	.156 (5/32)	A/32	.313 (5/16)	.078 (5/64)	.188 (3/16)
A/14	.355	.090	.188 (3/16)	A/33	.250 (1/4)	.078 (5/64)	.094 (3/32)
A/15	.425	.094 (3/32)	.259	A/34	.250 (1/4)	.062 (1/16)	.109 (7/64)
A/16	.328 (21/64)	.094 (3/32)	.188 (3/16)	A/35	.837	.575	.150
A/17	.375 (3/8)	.109 (7/64)	.125 (1/8)	A/36	.450	.250	.150
A/18	.375 (3/8)	.062 (1/16)	.172 (11/64)	A/37	.281	.038	.188
A/19	.375 (3/8)	.188 (3/16)	.094 (3/32)	A/38	.281	.069	.156

Assembly Procedure B

- 1) Trim cable per chart. Slide crimp sleeve back onto cable.

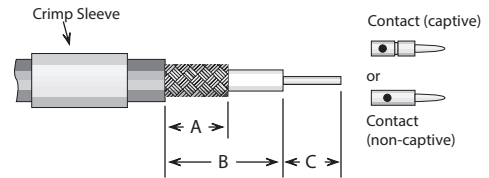

- 2) If support insulator is provided for RG-62 or 71 cable, insert into hollow in dielectric. Solder contact onto center conductor; back of contact flush with trimmed end of cable dielectric (omit this step for right angle connectors with access caps). Flare cut end of braid slightly by rotating dielectric.



- 3) Insert cable/contact into rear of body, with all braid wires on outside of crimp tail.
 - a) For captive contact connectors, push cable in until contact snaps into insulator.
 - b) For noncaptive contact connectors, push cable in until cable dielectric bottoms in connector.
 - c) For right angle or tee connectors with access caps, push cable in until end of braid touches connector body shoulder, and cable center conductor rests in contact slot.

Trim excess braid wires even with shoulder of body. Slide crimp sleeve forward until flush with body and crimp (see page 211 for hex die sizes).

For right angle or tee connectors with access caps: Solder center conductor into contact slot, assemble insulator disc (if supplied), then press cap into body until seated or screw into place.

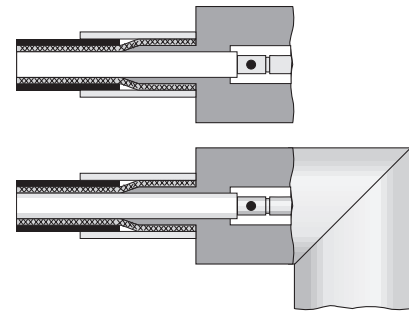

Trim Codes For Assembly Procedure B

Code	A	B	C	Code	A	B	C
B/01	.320	.470	.140	B/20	.250	.375	.156
B/02	.422	.578	.172	B/21	.425	.550	.156
B/03	.406	.500	.187	B/22	.375	.500	.156
B/04	.285	.505	.140	B/23	.281	.469	.125
B/05	.335	.460	.140	B/24	.250	.700	.109
B/06	.187	.437	.219	B/25	.343	.775	.125
B/07	.422	.610	.156	B/26	.343	.437	.109
B/08	.422	.562	.219	B/27	.313	.437	.187
B/09	.313	.610	.203	B/28	.219	.271	.078
B/10	.280	.436	.187	B/29	.200	.320	.060
B/11	.430	.542	.156	B/30	.500	.650	.219
B/12	.300	.434	.156	B/31	.350	.840	.150
B/13	.300	.447	.156	B/32	.175	.260	.095
B/14	.420	.645	.187	B/33	.195	.270	.045
B/15	.300	.420	.120	B/34	.150	.250	.105
B/16	.312	.609	.125	B/35	.195	.280	.170
B/17	.250	.500	.156	B/36	.150	.325	.090
B/18	.437	.562	.109	B/37	.195	.295	.075
B/19	.343	.437	.156	B/38	.150	.225	.095
				B/39	.250	.300	.135

Assembly Procedure C

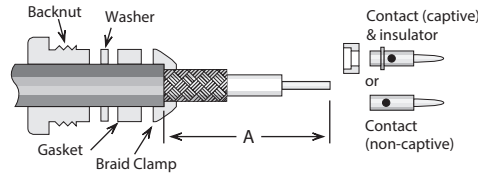

- 1) Trim cable jacket to dimension A. Slide backnut, washer, gasket, and braid clamp onto cable as shown. Cable jacket should bottom on step in braid clamp.

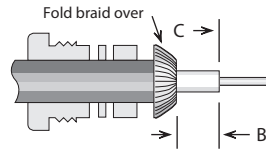

- 2) Comb braid wires out straight and fold back over front shoulder of braid clamp (braid wires should not overlap one another after folding). Trim braid wires flush with edge of braid clamp. Trim cable dielectric and center conductor to dimensions B and C.

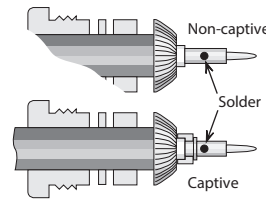

- 3) If support insulator is provided for RG-62 or 71 cable, insert into hollow in dielectric. Assemble rear insulator (if captive contact) and contact, and solder contact to center conductor. Rear of contact should be flush with cable dielectric end.

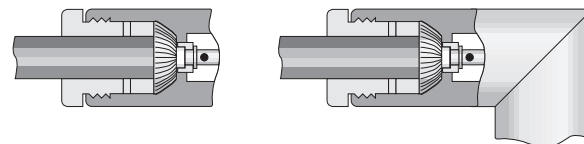

- 4) Insert prepared cable and hardware into body and tighten backnut. For right angle connectors with access cap, solder cable center conductor to slot in contact and tighten access cap.

Trim Codes

Code	A	B	C
C/01	.656 (21/32)	.141 (9/64)	.250 (1/4)
C/02	.500 (1/2)	.125 (1/8)	.250 (1/4)
C/03	.450	.136	.187
C/04	.375 (3/8)	.109 (7/64)	.125 (1/8)
C/05	.375 (3/8)	.062 (1/16)	.250 (1/4)
C/06	.500 (1/2)	.188 (3/16)	.125 (1/8)
C/07	.575	.438	.094
C/08	.625 (5/8)	.141 (9/64)	.219 (7/32)

Assembly Procedure D

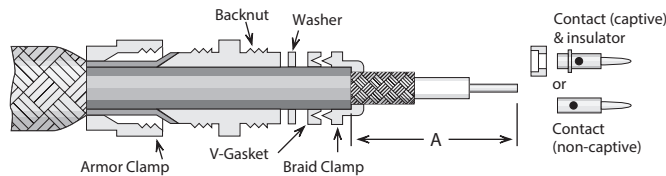

- 1) Slide armor clamp over cable. Push armor back to expose cable end. Slide backnut, washer (if supplied), gasket, and braid clamp onto cable as shown. Cable jacket should bottom on step in braid clamp. Trim cable jacket to dimension A.

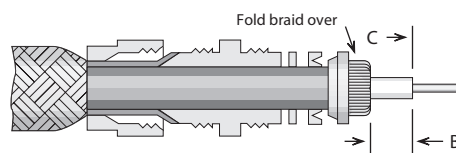

- 2) Comb braid wires out straight and fold back over front shoulder of braid clamp (braid wires should not overlap one another after folding). Trim braid wires flush with edge of braid clamp. Trim cable dielectric and center conductor to dimensions B and C.

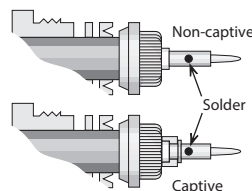

- 3) Assemble rear insulator (if captive contact) and contact, and solder contact to center conductor. Rear of contact should be flush with cable dielectric end.

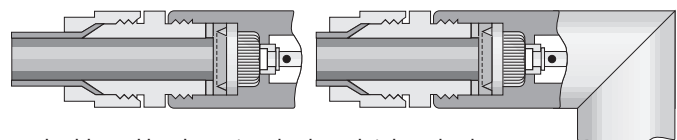

- 4) Insert prepared cable and hardware into body and tighten backnut. Trim armor to fit between armor clamp and braid clamp. Tighten armor clamp.

Trim Codes

Code	A	B	C
D/01	.375 (3/8)	.047 (3/64)	.250 (1/4)
D/02	.500 (1/2)	.188 (3/16)	.219 (7/32)
D/03	.344 (11/32)	.047 (3/64)	.219 (7/32)
D/04	.313 (5/16)	.047 (3/64)	.172 (11/64)
D/05	.625 (5/8)	.281 (9/32)	.250 (1/4)
D/06	.313 (5/16)	.062 (1/16)	.109 (7/64)

Assembly Procedure E

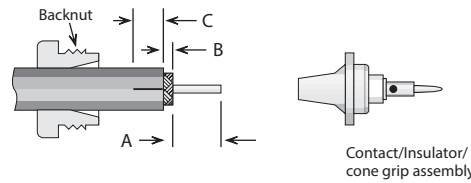

- 1) Slide backnut onto cable as shown. Trim cable to dimensions A and B as shown. Slit jacket to dimension C in two places, 180° apart.

Trim Codes			
Code	A	B	C
E/01	.250 (1/4)	.141 (9/64)	.313 (5/16)
E/02	.219 (7/32)	.063 (1/16)	.250 (1/4)
E/03	.250 (1/4)	.031 (1/32)	.250 (1/4)

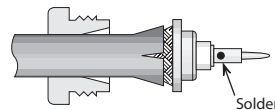

- 2) Slide cone/insulator/contact assembly under braid until braid is flush with shoulder. Solder contact to center conductor.

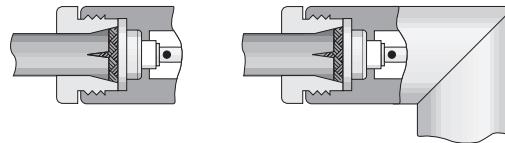

- 3) Insert prepared cable and hardware into body; tighten assembly by holding nut stationary and turning body.

Assembly Procedure F

Trim Codes		
Code	A	B
F/01	.250 (1/4)	.219 (7/32)
F/02	.250 (1/4)	.172 (11/64)
F/03	.188 (3/16)	.188 (3/16)
F/04	.109 (7/64)	.265 (17/64)
F/05	.156 (5/32)	.250 (1/4)
F/06	.219 (7/32)	.250 (1/4)
F/07	.156 (5/32)	.172 (11/64)
F/08	.109 (7/64)	.219 (7/32)

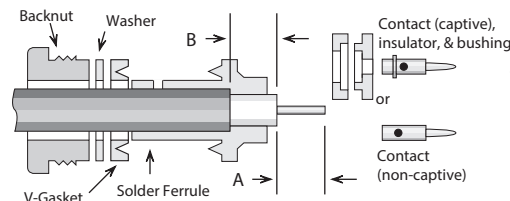

- 1) Trim cable per chart. Slide backnut, washer, v-gasket, and solder ferrule onto cable. Trimmed end of cable jacket should bottom on step in solder ferrule.

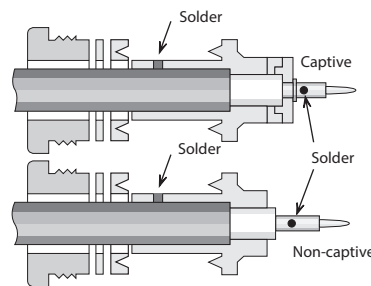

- 2) Solder ferrule to cable jacket as shown. Retrim cable dielectric to proper length if it has extruded from soldering heat. Slide bushing and rear insulator over cable dielectric if captive contact. Solder contact onto center conductor; back of contact flush with trimmed end of cable dielectric.

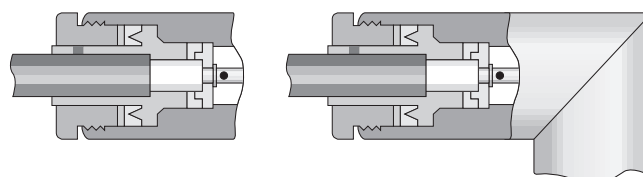

- 3) Insert prepared cable and hardware into body and tighten backnut.

Assembly Procedure G

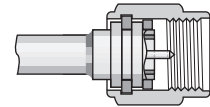
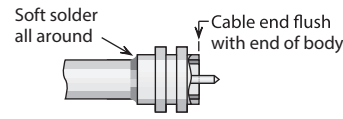
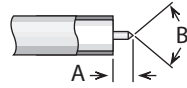
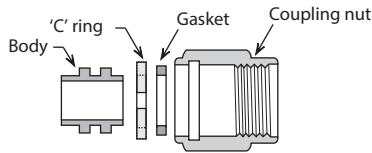

Trim Codes		
Code	A	B
G/01	.090	70-90°

- 1) Trim cable as shown. Remove any burrs from jacket and center conductor.
- 2) Soft solder cable jacket to body, making sure that end of cable is flush with end of body. After solder joint has cooled, retrim any protruding dielectric flush with end of body.
- 3) Assemble 'C' ring and gasket to body. Compress 'C' ring and slide body assembly into coupling nut until ring is seated in groove.

Assembly Procedure H

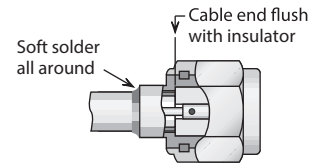
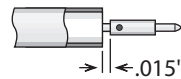
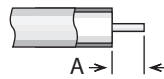
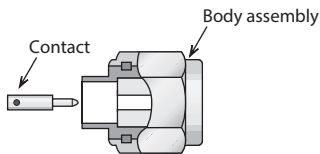

Trim Codes	
Code	A
H/01	.090
H/02	.060
H/03	.115
H/04	.150

- 1) Trim cable as shown. Remove any burrs from jacket and center conductor.
- 2) Solder contact to center conductor, fixturing to maintain gap as shown. Remove any excess solder from outside of contact.
- 3) Insert cable into body and solder cable jacket to body, keeping end of cable flush with insulator as shown.

Plug body assembly and contact shown; procedure is identical for jack connectors.

Assembly Procedure I

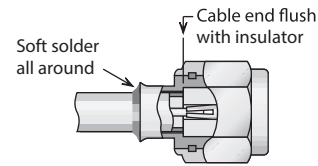
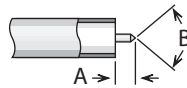
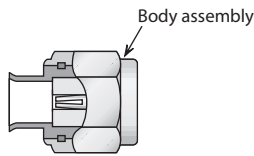

Trim Codes		
Code	A	B
I/01	.090	70-90°

- 1) Trim cable as shown. Remove any burrs from jacket and center conductor.
- 2) Insert cable into body and solder cable jacket to body, keeping end of cable flush with insulator as shown.

Plug body assembly and contact shown; procedure is identical for jack connectors.

Cable Positioner

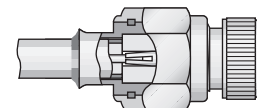
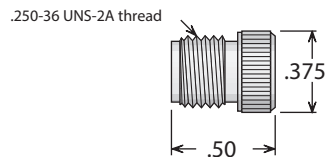

For .085" Cable:
P/N 63-10072-2

For .141" Cable:
P/N 63-10072-1

Using this positioner in the final step of assembly procedure H or I (for plugs only) will ensure that the contact and insulator are retained in the proper position to meet MIL-C-39012 requirements. The positioner should be screwed finger-tight into the mating end of the connector (as shown at right) before the cable jacket is soldered to the body assembly.

Assembly Procedure J

Trim Codes		
Code	A	B
J/01	.109	.047
J/02	.059	.039
J/03	.059	.079
J/04	.050	.059

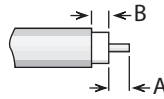

1) Trim cable as shown. Remove any burrs from jacket and center conductor.

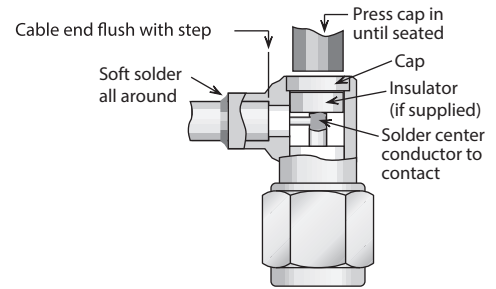

2) Soft solder cable jacket to body, making sure that end of cable is flush with step in body. Solder center conductor into contact slot, assemble insulator disc (if supplied), then press cap into body until seated or screw into place.

Assembly Procedure K

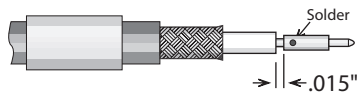
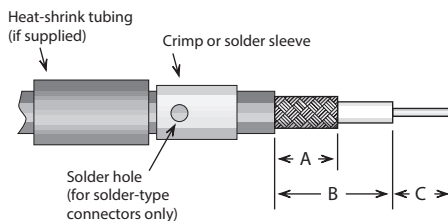

1) Trim cable per chart. Slide crimp (or solder) sleeve and heat-shrink tubing (if supplied) back onto cable.

2) Solder contact onto center conductor, fixturing to maintain gap as shown. Flare cut end of braid slightly by rotating dielectric.

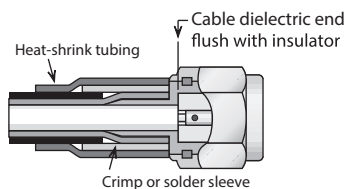

3) Insert cable/contact into rear of body, with all braid wires on outside of crimp tail. Push cable in until cable dielectric bottoms in connector. Trim excess braid wires even with shoulder of body. Slide crimp sleeve forward until flush with body and crimp (see page 211 for hex die sizes). (For solder-type connectors, solder braid to body and sleeve through hole in sleeve.) Slide heat-shrink tubing into place and shrink with hot-air gun.

Plug body assembly and contact shown; procedure is identical for jack connectors.

Trim Codes							
Code	A	B	C	Code	A	B	C
K/01	.250	.270	.110	K/07	.220	.290	.135
K/02	.200	.270	.140	K/08	.420	.620	.090
K/03	.225	.290	.110	K/09	.090	.135	.160
K/04	.225	.330	.110	K/10	.250	.415	.115
K/05	.250	.330	.110	K/11	.250	.400	.150
K/06	.250	.315	.095	K/12	.282	.390	.140

Assembly Procedure L

Trim Codes

Code	A	B	C
L/01	.250	.438	.109
L/02	.125	.219	.109
L/03	.234	.344	.109
L/04	.195	.270	.050
L/05	.095	.155	.050
L/06	.281	.390	.070

- 1) Trim cable per chart. Slide crimp (or solder) sleeve onto cable.

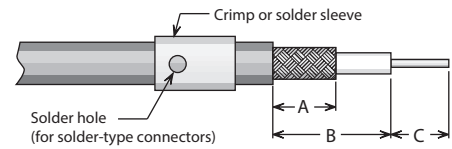

- 2) Insert cable into rear of body, with all braid wires on outside of crimp tail. Push cable in until end of braid touches connector body shoulder and center conductor rests in contact slot.

Slide crimp sleeve forward until flush with body and crimp (see page 211 for hex die sizes). (For solder-type connectors, solder braid to body and sleeve through hole in sleeve.)

Solder center conductor into contact slot, assemble insulator disc (if supplied), then press cap into body until seated or screw into place.

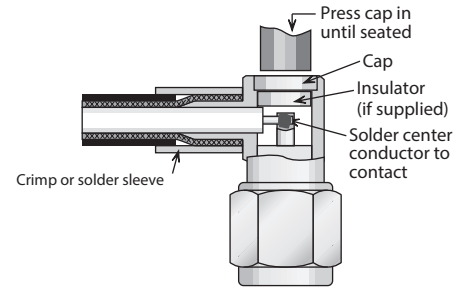

Assembly Procedure M

Cable Trim Codes

Code	A	B	C
M/01	.281	.390	.140

- 1) Trim cable per chart. Slide crimp (or solder) sleeve and backnut onto cable.

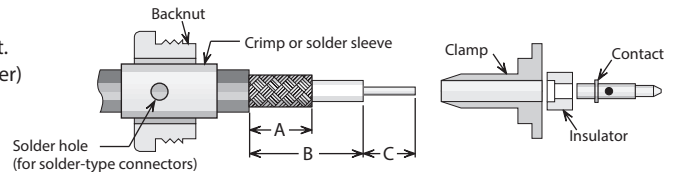

- 2) Flare cut end of braid slightly by rotating dielectric. Insert cable into rear of clamp, with all braid wires on outside of crimp tail. Slide insulator over cable dielectric until it is flush with front of clamp, and cable insulation bottoms inside insulator. Slide contact onto center conductor, with contact shoulder flush with front of insulator. Solder contact to center conductor.

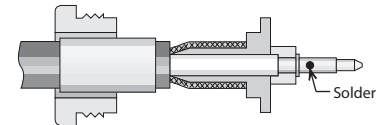

- 3) Slide crimp sleeve forward until flush with clamp shoulder; crimp as close to shoulder as possible. (see page 211 for hex die sizes). (For solder-type connectors, solder braid to body and sleeve through hole in sleeve.)

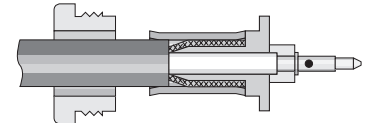

- 4) Insert prepared cable into back of body. Slide nut forward and tighten to 12–15 inch-pounds.

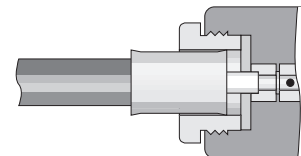

Crimp Tools For Flexible Cable



Frame only—P/N M22520/5-01 —Use with interchangeable dies listed below.

Cable Group*	Hex Die Size	Die Set P/N	Closure
2, 3, 4	.429 hex, .400 wide	M22520/5-61	A
5, 6	.213 hex, .400 wide	M22520/5-19	B
7	.255 hex, .400 wide	M22520/5-19	A
9	.128 hex, .400 wide	M22520/5-35	B
10	.151 hex, .400 wide	M22520/5-37	B
11	.105 hex, .400 wide	M22520/5-33	B

* For Delta cable groups. See MIL-PRF-39012 specifications for dies sizes used with M39012 cable groups.

Connector Flanges (Panel Mounted Connectors)

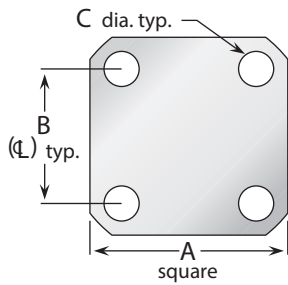

4-hole flanges			
Figure	A	B	C
04	1/2	.360	.089
05	1/2	.340	.102
07	11/16	.500	#3-56 tap
08	11/16	.500	.136
09	11/16	.500	.125
10	11/16	.500	.120
12	11/16	.500	.109
18	3/4	.531	.136
26	1	.718	#6-32 tap
27	1	.718	#4-40 tap
30	1	.718	.166
32	1	.718	.136
32A	1	.718	.136*
33	1	.718	.125
34	1 3/32	.812	.150
36	1 3/16	.906	#6-32 tap
39	1 3/16	.906	.152
40	1 3/16	.906	.125
45	2	1.437	.257
91	.375	.250	.067
91A	.375	.232	.093

* Countersunk to .245 dia.

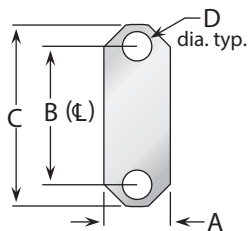

2-hole flanges				
Figure	A	B	C	D
92	.223	.481	.625	.102
92A	.260	.481	.625	.102
95	.640	1.015	1.30	.125

Panel Cutouts (Bulkhead Mounted Connectors)

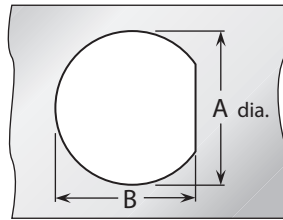

D-Hole		
Figure	A	B
51	.755	.723
54	.630	.598
55	.630	.583
57	.557	.531
59	.505	.473
62	.442	.410
63	.407	.362
65	.380	.348
66	.319	.292
67	.255	.236
68	.195	.176

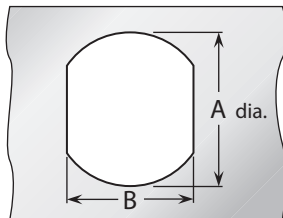

Double D-Hole		
Figure	A	B
69	.755	.692
72	.630	.536
75	.380	.341
84	.319	.278

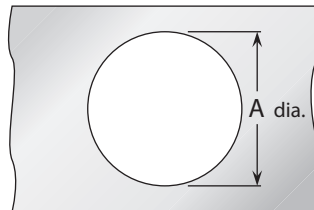

Round Hole	
Figure	A
82	.255
89	.380

P.C. Board Drilling

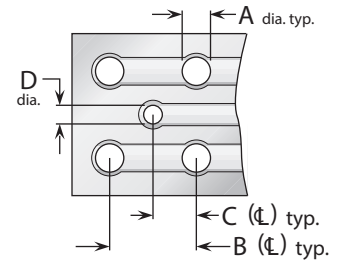

(PCB traces are shown for illustrative purpose only, and are not representative of actual circuitry.)

Coaxial connectors				
Figure	A	B	C	D
PCB01	.067	.400	.200	.045
PCB02	.045	.500	.250	.045
PCB03	.067	.300	.150	.035
PCB05	.067	.200	.100	.055
PCB06	.067	.200	.100	.045
PCB07	.045	.177	.088	.045
PCB08	.032	.100	.050	.032

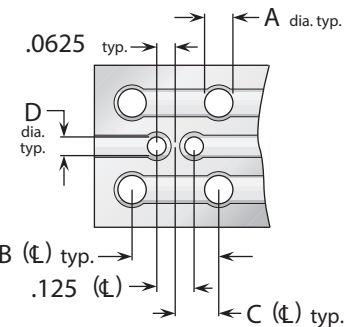

(PCB traces are shown for illustrative purpose only, and are not representative of actual circuitry.)

Twinax Connectors				
Figure	A	B	C	D
PCB04	.045	.500	.250	.045

Delta Cable Groups

Group	Cables
1	1A RG-5, 5A, 5B, 21, 21A; M17/73, /162
	1B RG-6, 6A; M17/2
	1C RG-143, 143A, 212, 222; M17/73, /112, /162
2	2A RG-8, 8A, 213; M17/74
	2B RG-11, 11A; M17/6
3	3A RG-9, 9A, 9B, 214; M17/75
	3B RG-13A, 216; M17/77
	3C RG-225; M17/127
4	RG-393; M17/127
5	RG-58, 58A, 58C, 141, 141A; M17/28, /111
6	6A RG-55A, 142, 142A, 223, 400; M17/60, /84, /128
	6B RG-55, 55B, 142B; M17/60, /84
7	7A RG-59, 59A, 59B, 62, 62A, 62B, 62C, 210; M17/29, /30, /97
	7B RG-71, 71A, 71B; M17/90
8	8A RG-122; M17/54
	8B RG-180, 180A, 180B, 195; M17/95, /137
9	9A RG-174, 188, 188A, 316; M17/152
	9B RG-179A, 179B, 187, 187A; M17/94, /136
10	Double-Shielded RG-174, 316; M17/152
11	RG-178, 178A, 178B, 196, 196A; M17/93
12	.250" semi-rigid; RG-401; M17/129
13	.141" semi-rigid; RG-402; M17/130
14	.085" semi-rigid; RG-405; M17/133
15	RG-10, 12, 215; M17/6, /74
16	RG-14A, 217; M17/78, /165
17	RG-17A, 218
18	RG-18A, 219
19	RG-115A
20	RG-118A, 228A
21	RG-126
22	RG-302
23	RG-303
24	RG-304
25	Special 8X cable; contact factory for details.
26	Belden 8281
27	RG-108, 108A; M17/45
28	RG-22, 22A, 22B; M17/15
29	Belden 9207; Dearborn 6207; IBM 7362211
30	M17/176
31	AT&T 735A

Cable Group Finder

Cable	Group	Cable	Group
RG-5, 5A, B	1A	RG-225	3C
RG-6, 6A	1B	RG-228A	20
RG-8, 8A	2A	RG-302	22
RG-9, 9A, B	3A	RG-303	23
RG-10	15	RG-304	24
RG-11, 11A	2B	RG-316	9A
RG-12	15	RG-316DS	10
RG-13A	3B	RG-393	4
RG-14A	16	RG-400	6A
RG-17A	17	RG-401	12
RG-18A	18	RG-402	13
RG-21, 21A	1A	RG-405	14
RG-22, 22A, B	28	M17/2	1B
RG-55, 55B	6B	M17/6	2B
RG-55A	6A	M17/15	28
RG-58, 58A, C	5	M17/28	5
RG-59, 59A, B	7A	M17/29	7A
RG-62, 62A, B, C	7A	M17/30	7A
RG-71, 71A, B	7B	M17/45	27
RG-108, 108A	27	M17/73	1A
RG-115A	19	M17/162	1A
RG-118A	20	M17/112	1C
RG-122	8A	M17/74	2A
RG-126	21	M17/75	3A
RG-141, 141A	5	M17/127	3C
RG-142, 142A	6A	M17/77	3B
RG-142B	6B	M17/60	6A
RG-143, 143A	1C	M18/84	6A
RG-174	9A	M17/128	6A
RG-174DS	10	M17/97	7A
RG-178, 178A, B	11	M17/54	8A
RG-179A, 179B	9B	M17/95	8B
RG-180, 180A, B	8B	M17/137	8B
RG-187, 187A	9B	M17/152	9A
RG-188, 188A	9A	M17/93	11
RG-195	8B	M17/129	12
RG-196, 196A	11	M17/130	13
RG-210	7A	M17/133	14
RG-212	1C	M17/78	16
RG-213	2A	M17/165	16
RG-214	3A	M17/176	30
RG-215	15	AT&T 735A	31
RG-217	16	Belden 8281	26
RG-218	17	Belden 9207	29
RG-219	18	Dearborn 6207	29
RG-222	1C	IBM 7362211	29
RG-223	6A		

Note: MIL-PRF-39012 QPL connectors have cable groups defined by the MIL specification, not the Delta cable groups shown here. See page 185 for M39012 cable groups.

Warranty

We warrant our parts to be free of defects and workmanship for one year from purchase. During that time we will repair or replace (at our option) any parts found to be defective. The warranty does not apply to parts that have been modified, used in conditions exceeding Seller's, or military specifications, or disassembled. We will not, under any circumstances, be responsible for consequential or incidental damages or installation costs. No other warranties apply, and no other liability may be assumed or extended by representatives or distributors. The terms of the applicable warranty or warranties, as the case may be, as set forth herein are the sole and exclusive warranty terms that shall have any force or effect in the any product order, resulting from the quotation and such terms and in lieu of all other warranties, expressed or implied, including the implied warranties of merchantability and fitness for a particular purpose, which are hereby expressly excluded.



Returns

Returns will be accepted only with a Return Authorization number issued by Delta, and are subject to inspection and acceptance upon arrival. Restocking charges will be determined prior to issuance of Return Authorization. All claims for shortages must be made within 30 days of receipt by customer.

Ordering Information

Orders are subject to the terms and conditions on our order acknowledgement, which may only be modified by written agreement prior to sale. Order changes, cancellation, or termination will be accepted only with written approval from Delta Electronics Manufacturing.

Copyright, Trademarks, & Patents

Entire contents copyright 2017, Delta Electronics Manufacturing Corporation. Reproduction rights are hereby granted for, and specifically limited to, printing or other reproduction of drawings and specifications for inclusion in specification or source control drawings, or purchasing procedures, by Delta customers only.

Heli-Grip[®], PressMount[®], and Global Manufacturer logo are trademarks. The Heli-Grip design is covered by U.S. and foreign patents

Delta Electronics Manufacturing Corporation
416 Cabot Street, P.O. Box 53
Beverly, MA 01915
FSCM/CAGE 00795