

PATRZ UWAGA 1  
SEE NOTE 1

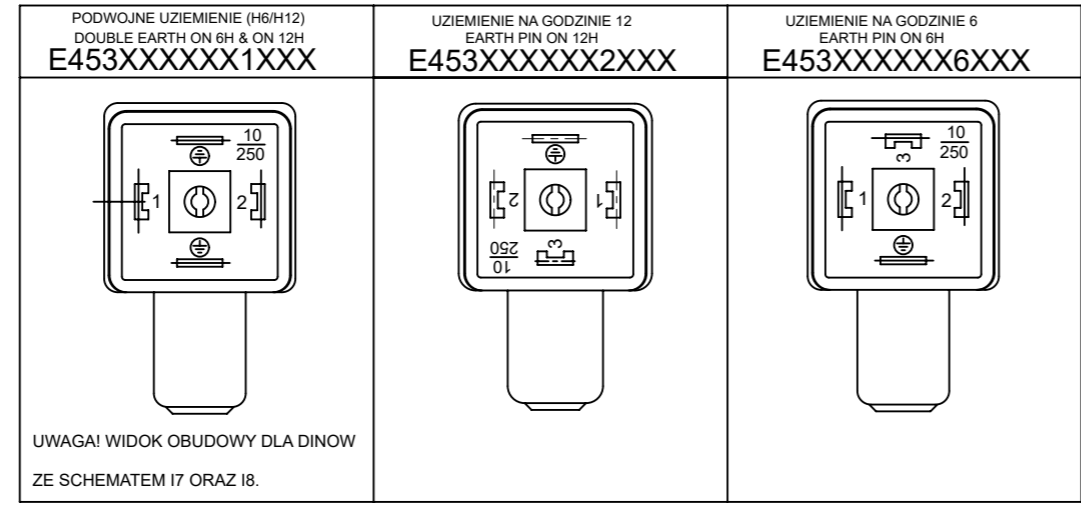
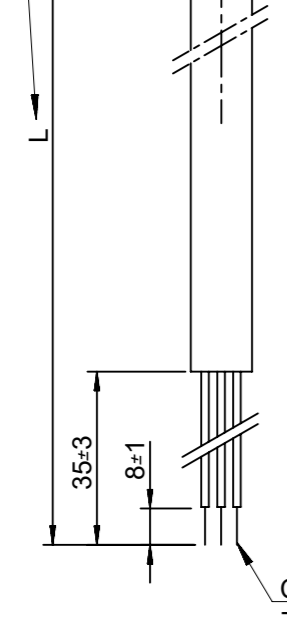
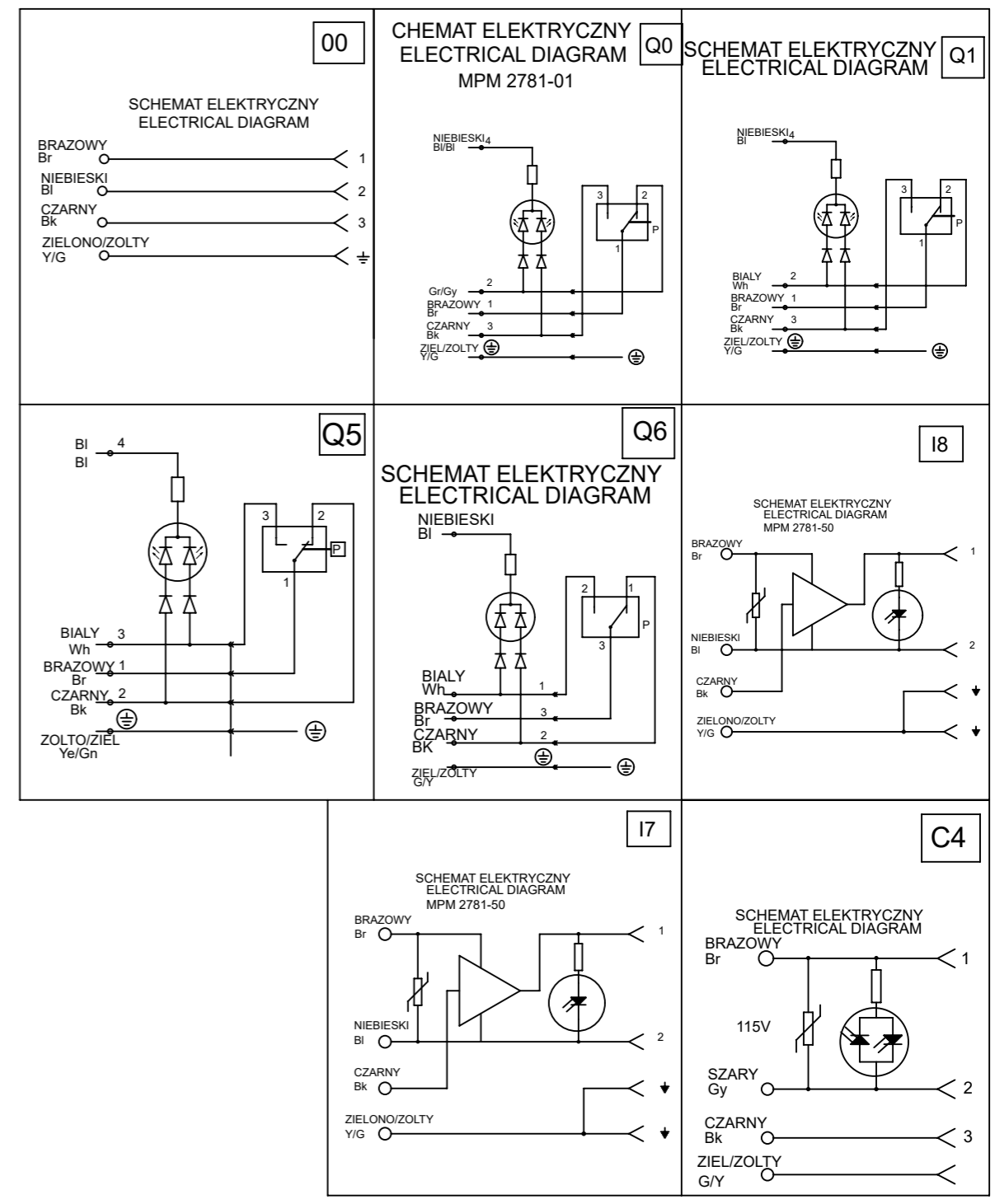

Table of length tolerances/ Tablica tolerancji dlugosci mm		
Over/Od	Up to and including/ Do-wlacznie	Tolerance/Tolerancja
100	1000	±20
1000	3000	±30
3000	5000	±40
5000	10000	±50
10000	15000	±100
15000	20000	±150
20000		±L/100

UWAGI:  
1. DLUGOSC PATRZ ARKUSZ 2.

NOTES:  
1. LENGHT SEE SHEET 2.

SCHEMATY POLACZEN/WIRING CONFIGURATION



PRE-RELEASE  
REFERENCE  
USE ONLY

THIS DRAWING CONTAINS INFORMATION THAT IS PROPRIETARY TO MOLEX ELECTRONIC TECHNOLOGIES, LLC AND SHOULD NOT BE USED WITHOUT WRITTEN PERMISSION		CURRENT REV DESC: OBSOLETE PART NUMBER		<b>molex</b>	
GENERAL TOLERANCES (UNLESS SPECIFIED)		EC NO: 650268			
DIMENSION UNITS	SCALE	DRWN: SUGEEB 2020/10/20		MPM E453XXXXXXXXXX	
mm	NTS	CHK'D: GGA 2020/12/18		PRODUCT CUSTOMER DRAWING	
4 PLACES ± ±		APPR: GGA 2020/12/18		DOCUMENT NUMBER	
3 PLACES ± ±		INITIAL REVISION:		DOC TYPE DOC PART REVISION	
2 PLACES ± ±		DRWN: MWOLSZCZAK 2009/01/20		E453XXXXXXXXXX PSD 001 B	
1 PLACE ± ±		APPR: GOGRODNIK 2009/01/20			
0 PLACES ± ±		DRAFT WHERE APPLICABLE MUST REMAIN WITHIN DIMENSIONS		MATERIAL NUMBER CUSTOMER SHEET NUMBER	
ANGULAR TOL ± °		FIRST ANGLE PROJECTION	DRAWING	SERIES	SEE TABLE GENERAL MARKET 1 OF 4
			A3-SIZE	121040	

E 4 5 3 X X X X X X X X X X X

E - Pakowanie bez workow  
 W - Pakowanie pojedynczo  
 Q - Szybkie pakowanie

ILOSC PRZEWODOW/NUMBER OF WIRES:  
 1=2 PRZEWODY,  
 2=2 PRZEWODY+UZIEMIENIE,  
 3=3 PRZEWODY+UZIEMIENIE.

TYP KABLA/CABLE TYPE  
 PATRZ TABELA 1/SEE TABLE 1

RODZAJ KABLA/CABLE CROSS SECTION AREA  
 PATRZ TABELA 2/SEE TABLE 2

KOLOR MOULDINGU/HEAD COLOUR:  
 G=SZARY/GREY;  
 N=CZARNY/BLACK;  
 T=PRZETROCZYSTY/TRANSPARENT;  
 A=CZARNY/BLACK;  
 B=SZARY/GREY.

DLUGOSC KABLA W CM/CABLE LENGHT IN CM  
 NP:050=50 CM, 300=300 CM.

POLOZENIE PINU Z UZIEMIENIEM/EARTH PIN LOCATION:  
 1=PODWOJNE UZIEMIENIE NA GODZINIE 6 ORAZ 12/DOUBLE EARTH ON 6H AND 12H,  
 2=UZIEMIENIE NA GODZINIE 12/1EARTH ON 12H,  
 6=UZIEMIENIE NA GODZINIE 6/EARTH ON 6H.

GASKET ORAZ SRUBY/GASKET SCREWS:  
 1=GASKET PROFILOWANY+SRUBA/NBR PROFILE GASKET+FIXING SCREWS,  
 2=NBR PLASKI GASKET+SRUBA/NBR FLAT GASKET+SCREW,  
 3=SILIKONOWY PROFILOWANY GASKET+SRUBA/SILICONE PROFILE GASKET+SCREW,  
 4=SILIKONOWY PLASKI GASKET+SRUBA/SILICON FLAT GASKET+SCREW,  
 P=ZINTEGROWANY GASKET+SRUBA/INTEGRATED GASKET+FIXING SCREW,  
 R=ZINTEGROWANY GASKET+SRUBA/INTEGRATED GASKET+SCREW,  
 T=PROFILOWANY GASKET+SRUBA, PROFILE GASKET+SCREW.

RODZAJ POLACZENIA/INTERNAL CIRCUIT  
 PATRZ SCHEMATY POLACZEN/WIRING CONFIGURATION

NAPIECIE ORAZ KOLOR DIODY/VOLTAGE AND LED COLOUR:

1= 12V	} CZERWONA DIODA RED LED	A= 12V	} ZIELONA DIODA GREEN LED	G= 12V	} ZOLTA DIODA YELLOW LED
2= 24V		B= 24V		H= 24V	
3= 48V		C= 48V		K= 48V	
4= 115V		D= 115V		L= 115V	
5= 230V		E= 230V		M= 230V	

PRE-RELEASE  
 REFERENCE  
 USE ONLY

THIS DRAWING CONTAINS INFORMATION THAT IS PROPRIETARY TO MOLEX ELECTRONIC TECHNOLOGIES, LLC AND SHOULD NOT BE USED WITHOUT WRITTEN PERMISSION											
DIMENSION UNITS		SCALE		CURRENT REV DESC: OBSOLETE PART NUMBER						<b>molex</b>	
mm		NTS									
GENERAL TOLERANCES (UNLESS SPECIFIED)				EC NO: 650268		DRWN: SUGEEB		2020/10/20		MPM E453XXXXXXXXXX	
				CHK'D: GGA		2020/12/18		PRODUCT CUSTOMER DRAWING			
				APPR: GGA		2020/12/18					
				INITIAL REVISION:				DOCUMENT NUMBER		DOC TYPE DOC PART REVISION	
				DRWN: MWOLSZCZAK		2009/01/20		E453XXXXXXXXXX		PSD 001 B	
				APPR: GOGRODNIK		2009/01/20					
DRAFT WHERE APPLICABLE MUST REMAIN WITHIN DIMENSIONS				FIRST ANGLE PROJECTION		DRAWING		SERIES		SHEET NUMBER	
						A3-SIZE		121040		2 OF 4	

TABELA 2 KABLE/TABLE 2 CABLES

MOLEX PN	mPm	Code	PRZEW	PRZEKROJ	MATERIAL	KOLOR/COLOUR	SREDNICA Ø	DIN A-B	DIN C
1210180080	I	0	3	1 mm2	PVC CEI 2022 II O.R.	Szary/Grey RAL7035	-	-	-
1210180467	A	2	2	20 AWG	PVC CSA/UL 2661	Czarny/Black	5,5+/-0,2 mm	OK.	OK.
-	A	2	3	20 AWG	PVC CSA/UL 2661	Czarny/Black	5,6+/-0,2 mm	OK.	OK.
1210180394	A	2	4	20 AWG	PVC CSA/UL 2661	Czarny/Black	6,2+/-0,2 mm	OK.	OK.
-	A	2	5	20 AWG	PVC CSA/UL 2661	Czarny/Black	7+/-0,2 mm	OK.	
1210180297	B	2	2	20 AWG	PUR CSA/UL 20668	Czarny/Black	5,5+/-0,2 mm	OK.	OK.
1210180126	B	2	3	20 AWG	PUR CSA/UL 20668	Czarny/Black	5,6+/-0,2 mm	OK.	OK.
1210180387	B	2	4	20 AWG	PUR CSA/UL 20668	Czarny/Black	6,2+/-0,2 mm	OK.	OK.
-	B	2	5	20 AWG	PUR CSA/UL 20668	Czarny/Black	7+/-0,2 mm	OK.	
1210180122	D	2	3	0,5 mm2	PVC T12 CEI 20-20	Szary/Grey	-	-	-
-	F	2	3	0,5 mm2	CNOMO	Szary/Grey RAL7000	5,5+/-0,2 mm	OK.	OK.
1210180047	I	2	2	0,5 mm2	PVC CEI 2022 II O.R.	Szary/Grey RAL7035	5,5+/-0,2 mm	OK.	OK.
-	I	2	3	0,5 mm2	PVC CEI 2022 II O.R.	Szary/Grey RAL7035	5,5+/-0,2 mm	OK.	OK.
1210180146	I	2	4	0,5 mm2	PVC CEI 2022 II O.R.	Szary/Grey RAL7035	6,5+/-0,2 mm	OK.	
1210180177	I	2	5	0,5 mm2	PVC CEI 2022 II O.R.	Szary/Grey RAL7035	7+/-0,2 mm	OK.	
1210180022	N	2	2	0,5 mm2	PVCH03	Czarny/Black	5,1+ 0,2-0 mm	OK.	OK.
1210180064	N	2	3	0,5 mm2	PVCH03	Czarny/Black	5,4+ 0,2-0 mm	OK.	OK.
1210180153	N	2	4	0,5 mm2	PVCH03	Czarny/Black	5,75+0,2-0 mm	OK.	OK.
1210180046	P	2	2	0,5 mm2	PUR - BLEND	Czarny/Black	5,5+/-0,2 mm	OK.	OK.
-	P	2	3	0,5 mm2	PUR - BLEND	Czarny/Black	5,5+/-0,2 mm	OK.	OK.
1210180302	P	2	4	0,5 mm2	PUR - BLEND	Czarny/Black	-	-	-
-	P	2	5	0,5 mm2	PUR - BLEND	Czarny/Black	7+/-0,2 mm	OK.	OK.
1210180409	A	3	2	18 AWG	PVC CSA/UL 2661	Czarny/Black	6,5+/-0,2 mm	OK.	
1210180129	A	3	3	18 AWG	PVC CSA/UL 2661	Czarny/Black	6,5+/-0,2 mm	OK.	
1210180159	A	3	4	18 AWG	PVC CSA/UL 2661	Czarny/Black	7+/-0,2 mm	OK.	
-	A	3	5	18 AWG	PVC CSA/UL 2661	Czarny/Black	7,8+/-0,2 mm	OK.	
1210180351	B	3	2	18 AWG	PUR CSA/UL 20668	Czarny/Black	6,5+/-0,2 mm	OK.	
1210180127	B	3	3	18 AWG	PUR CSA/UL 20668	Czarny/Black	6,5+/-0,2 mm	OK.	
1210180127	B	3	4	18 AWG	PUR CSA/UL 20668	Czarny/Black	7+/-0,2 mm	OK.	
-	B	3	5	18 AWG	PUR CSA/UL 20668	Czarny/Black	7,8+/-0,2 mm	OK.	
1210180073	D	3	3	0,75 mm2	PVC T12 CEI 20-20	Szary/Grey	-	-	-
1210180145	D	3	4	0,75 mm2	PVC T12 CEI 20-20	Szary/Grey	-	-	-
1210180120	I	3	3	0,75 mm2	PVC CEI 2022 II O.R.	Szary/Grey RAL7035	-	-	-
1210180143	I	3	4	0,75 mm2	PVC CEI 2022 II O.R.	Szary/Grey RAL7035	-	-	-
1210180032	N	3	2	0,75 mm2	PVCH05	Czarny/Black	6,2+ 0,2-0 mm	OK.	
1210180069	N	3	3	0,75 mm2	PVCH05	Czarny/Black	6,6+0,2-0 mm	OK.	
-	N	3	4	0,75 mm2	PVCH05	Czarny/Black	7,15+0,2-0 mm	OK.	
1210180174	N	3	5	0,75 mm2	PVCH05	Czarny/Black	8,0+0,2-0 mm	OK.	
-	P	3	2	0,75 mm2	PUR - BLEND	Czarny/Black	6,5+/-0,2 mm	OK.	

TABELA 2 KABLE/TABLE 2 CABLES

MOLEX PN	mPm	Code	PRZEW	PRZEKROJ	MATERIAL	KOLOR/COLOUR	SREDNICA Ø	DIN A-B	DIN C
1210180071	P	3	3	0,75 mm2	PUR - BLEND	Czarny/Black	6,5+/-0,2 mm	OK.	
1210180152	P	3	4	0,75 mm2	PUR - BLEND	Czarny/Black	7+/-0,2 mm	OK.	
1210180384	R	3	3	0,75 mm2	TPR HAL. FREE	Czarny/Black	6,5+/-0,2 mm	OK.	
1210180094	T	3	3	0,75 mm2	PUR CSA/UL	Żółty/Yellow	-	-	-
1210180309	Y	3	3	0,75 mm2	SIL/0300	Czerwony/Red	6,5+/-0,2 mm	-	-
1210180081	F	4	3	1 mm2	CNOMO	Szary/Grey RAL7000	-	-	-
-	F	4	4	1 mm2	CNOMO	Szary/Grey RAL7000	7,1+0,2-0 mm	OK.	
1210180042	I	4	2	1 mm2	PVC CEI 2022 II O.R.	Szary/Grey RAL7035	7,1+0,2-0 mm	OK.	
1210180079	I	4	3	1 mm2	PVC CEI 2022 II O.R.	Szary/Grey RAL7035	7,1+0,2-0 mm	OK.	
1210180036	N	4	2	1 mm2	PVCH05	Czarny/Black	6,5+0,2-0 mm	OK.	
1210180082	N	4	3	1 mm2	PVCH05	Czarny/Black	6,9+0,2-0 mm	OK.	
1210180117	R	4	3	1 mm2	TPR HAL. FREE	Czarny/Black	-	-	-
1210180085	N	5	3	1,5 mm2	PVCH05	Czarny/Black	8,3+0,2-0 mm	OK.	
1210180313	I	6	2	0,35 mm2	PVC CEI 2022 II O.R.	Szary/Grey RAL7035	-	-	-
-	A	7	3	20 AWG	PVC CSA/UL 2661	Żółty/Yellow	5,6+/-0,2 mm	OK.	OK.
1210180149	I	9	4	0,75 mm2	PVC CEI 2022 II O.R.	Szary/Grey RAL7035	-	-	-

TABELA 1 TYPY KABLI/TABLE 1 CABLES TYPE

Znakowanie /Code	Rodzaje kabla /Cable type	Właściwości / Features	Przekroje /stranding
N	PVC	Kabel z dobrą rezystancją w wodzie ale słabą w oleju./Application general purpose cable which has good resistance to water, but usually poor oil resistance.	0.5 mm2 = 15 x 0.20 0.75 mm2 = 21 x 0.20 1 mm2 = 28 x 0.20
I	PVC	Zatwierdzone przez IEC 332-2A, samogaszący./Approved to IEC 332-2A, flame retardant and self extinguishing. Limited resistant to mineral oils.	0.5 mm2 = 28 x 0.15 0.75 mm2 = 42 x 0.15 1 mm2 = 32 x 0.20
P	PVC	Dobra rezystancja w olejach i chemikaljach./Offer good resistance to oil and chemicals. Can swell when constantly immersed in water.	0.5 mm2 = 28 x 0.15 0.75 mm2 = 42 x 0.15 1 mm2 = 32 x 0.20
A	PVC	Zatwierdzony porzez CSA-UL 2661.Dobra rezystancja na wode słaba na olej./ Approved to CSA-UL 2661, application general purpose cable which has good resistance to water, but usually poor oil resistance.	20 AWG = 32 x 0.15 18 AWG = 52 x 0.15
B	PVC	Zatwierdzony przez CSA-UL 20668, bardzo dobra rezystancja w oleju i chemikaljach./ Approved to CSA-UL 20668, very good resistance to oil and chemicals.	20 AWG = 32 x 0.15 18 AWG = 52 x 0.15

PRE-RELEASE REFERENCE USE ONLY

THIS DRAWING CONTAINS INFORMATION THAT IS PROPRIETARY TO MOLEX ELECTRONIC TECHNOLOGIES, LLC AND SHOULD NOT BE USED WITHOUT WRITTEN PERMISSION		CURRENT REV DESC: OBSOLETE PART NUMBER		<b>molex</b>	
DIMENSION UNITS	SCALE				
mm	NTS			MPM E453XXXXXXXXXX	
GENERAL TOLERANCES (UNLESS SPECIFIED)				PRODUCT CUSTOMER DRAWING	
	MM	INCH			
4 PLACES	±	±			
3 PLACES	±	±			
2 PLACES	±	±			
1 PLACE	±	±			
0 PLACES	±	±			
ANGULAR TOL	± °				
DRAFT WHERE APPLICABLE MUST REMAIN WITHIN DIMENSIONS		FIRST ANGLE PROJECTION	DRAWING	SERIES	MATERIAL NUMBER
			A3-SIZE	121040	SEE TABLE
					CUSTOMER
					GENERAL MARKET
					SHEET NUMBER
					3 OF 4

TABELA 3/CHART 3

MOLEX P/N	WOODHEAD P/N
1210400525	E453B3A10K22000
1210400526	E453B3A10K62000
1210400527	E453B3A30022000
1210400528	E453B3A30062000
1210400529	E453B3A50022000
1210400530	E453B3A50062000
1210400539	E453N3N30022000
1210400540	E453N3N30062000
1210400541	E453N3N50022000
1210400547	E453P3N30022000
1210400550	E453P3N50022000
1210400698	E453A3A10K62000
1210400796	E453N3N20062000
1210400833	E453A3A10022000
1210400864	E453B2A30022000
1210400937	E453N3N2002P000
1210400953	E453N3N1002P000
1210400967	E453N3N5002P000
1210400973	E453P3N2502P000
1210400980	E453A3A15K62000
1210500845	E453I3N30021Q62
1210500889	E453P2N30021Q02
1210501823	E453P2N50061Q12
1210501868	E453P2N30021Q52
1210502033	E453P3N4001118H
1210502410	E453I2N30021Q12
1210502440	E453I2N50021Q12

MOLEX P/N	WOODHEAD P/N
1210502454	E453B3A50021Q02
1210502455	E453B3A30021Q02
1210502517	E453I2N10K21Q12
1210502557	E453I2N50021Q02
1210502562	E453N3N30022C44
1210501787	E453N3N30061Q02
1210502887	W453P2G5006RQ02
1210501794	E453I3N10K61Q02
1210501869	E453P2N50021Q52
1210503035	E453N2N20061C42

PRE-RELEASE  
REFERENCE  
USE ONLY

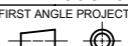
THIS DRAWING CONTAINS INFORMATION THAT IS PROPRIETARY TO MOLEX ELECTRONIC TECHNOLOGIES, LLC AND SHOULD NOT BE USED WITHOUT WRITTEN PERMISSION									
DIMENSION UNITS		SCALE		CURRENT REV DESC: OBSOLETE PART NUMBER					
mm		NTS							
GENERAL TOLERANCES (UNLESS SPECIFIED)				EC NO: 650268		2020/10/20		MPM E453XXXXXXXXXX	
				DRWN: SUGEEB		2020/12/18			
				CHK'D: GGA		2020/12/18			
				APPR: GGA		2020/12/18		PRODUCT CUSTOMER DRAWING	
				INITIAL REVISION:				DOCUMENT NUMBER	
				DRWN: MWOLSZCZAK		2009/01/20		E453XXXXXXXXXX	
				APPR: GOGRODNIK		2009/01/20		PSD 001 B	
ANGULAR TOL ± °				FIRST ANGLE PROJECTION		DRAWING		SERIES	
DRAFT WHERE APPLICABLE MUST REMAIN WITHIN DIMENSIONS						A3-SIZE		121040	
				MATERIAL NUMBER		CUSTOMER		SHEET NUMBER	
				SEE TABLE		GENERAL MARKET		4 OF 4	

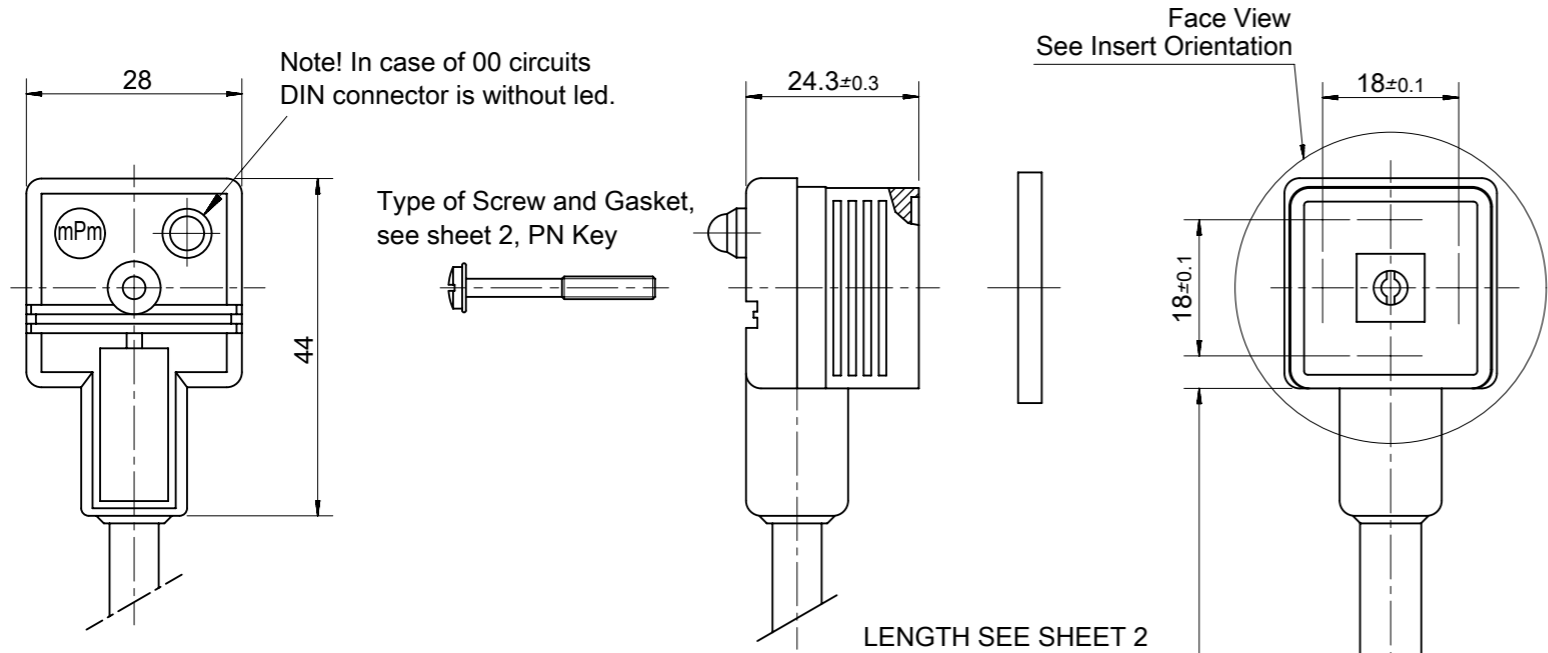

INSERT ORIENTATION

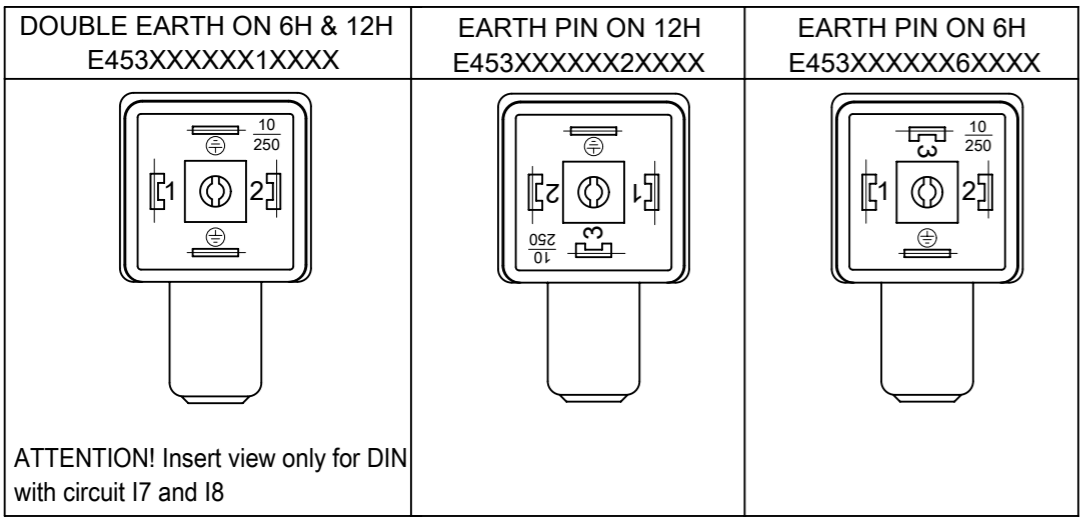
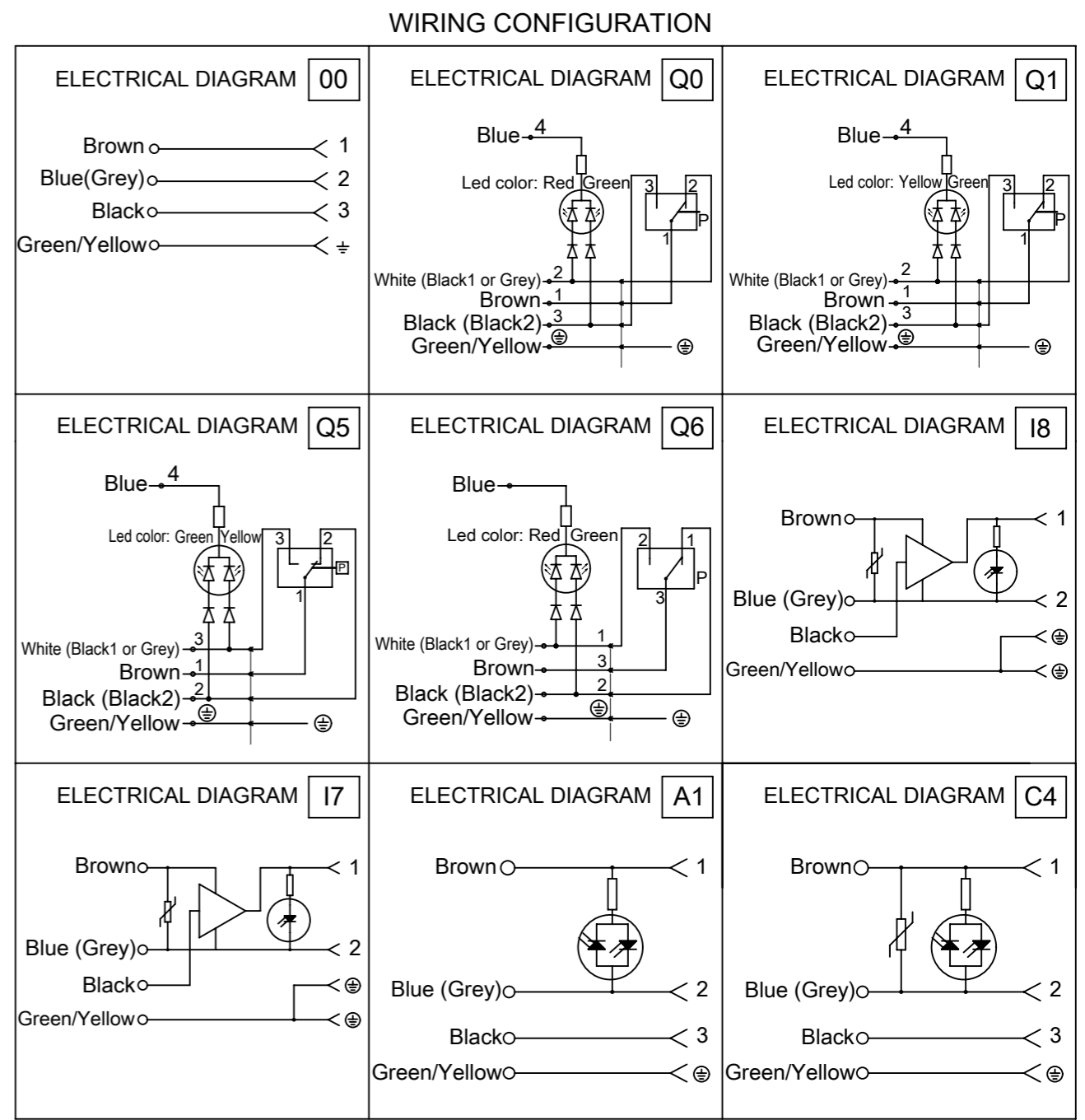

Table of length tolerances [mm]		
Over	Up to and including	Tolerance (+)
0	1000	±20
1000	3000	±30
3000	5000	±40
5000	10000	±50
10000	15000	±100
15000	20000	±150
20000		±L/100



THIS DRAWING CONTAINS INFORMATION THAT IS PROPRIETARY TO MOLEX ELECTRONIC TECHNOLOGIES, LLC AND SHOULD NOT BE USED WITHOUT WRITTEN PERMISSION

DIMENSION UNITS	SCALE	CURRENT REV DESC: OBSOLETE PART NUMBERS	
mm	NTS		
GENERAL TOLERANCES (UNLESS SPECIFIED)			
	MM	INCH	
4 PLACES	±	±	
3 PLACES	±	±	
2 PLACES	±	±	
1 PLACE	±	±	
0 PLACES	±	±	
ANGULAR TOL	± °		
DRAFT WHERE APPLICABLE MUST REMAIN WITHIN DIMENSIONS	THIRD ANGLE PROJECTION	DRAWING	SHEET NUMBER
		A3-SIZE	121050

EC NO: 638770	DRWN: RPRABHUM	2020/03/05
CHK'D: GGA	APPR: GGA	2020/07/21
INITIAL REVISION:	DRWN: JMARSZALEK	2012/11/27
	APPR: MIWASIECZKO	2014/01/30

DOCUMENT NUMBER	DOC TYPE	DOC PART	REVISION
SD-121050-006	PSD	001	D
MATERIAL NUMBER	CUSTOMER	SHEET NUMBER	
SEE SHEET 2 & 4	GENERAL MARKET	1 OF 10	

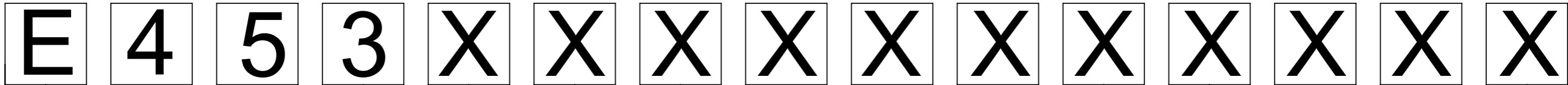

E - Packing without bags  
 W - Single packing  
 Q - Quick packing

NUMBER OF WIRES:  
 3=3 WIRES + EARTH  
 OR  
 3=4 WIRES + EARTH (FOR Q CIRCUIT)

CABLE TYPE  
 SEE SHEET 3 - TABLE 1

CABLE CROSS SECTION AREA  
 SEE SHEET 3 - TABLE 2

HEAD COLOUR:

N=BLACK;  
 A=CSA-UL BLACK;  
 B=CSA-UL GREY.

CABLE LENGTH IN CM  
 Eg.:050=50 CM, 300=300 CM, 10K=1000 CM.

EARTH PIN LOCATION (SEE INSERT ORIENTATION TABLE):

1=DOUBLE EARTH ON 6H AND 12H,  
 2=EARTH ON 12H,  
 6=EARTH ON 6H.

TYPE OF GASKET AND SCREW:

1=NBR PROFILE GASKET + FIXING SCREWS (M3x25 mm)  
 2=NBR FLAT GASKET + FIXING SCREW (M3x25 mm)  
 3=SILICONE PROFILE GASKET + FIXING SCREW (M3x25 mm)  
 4=SILICON FLAT GASKET + FIXING SCREW (M3x25 mm)  
 P=INTEGRATED GASKET ASSEMBLED + FIXING SCREW WITH WASHER ASSEMBLED (M3x27 mm)  
 R=INTAGRATED GASKET + FIXING SCREW + WASHER (M3x27 mm)  
 T=PROFILE GASKET + FIXING SCREW + WASHER (M3x27 mm)

INTERNAL CIRCUIT, WIRING CONFIGURATION

VOLTAGE AND LED COLOUR:

NOTE: FOR CIRCUIT TYPE Q - BICOLOR LED - ONLY 1,2,3,4,5

1= 12V	} RED LED	A= 12V	} GREEN LED	G= 12V	} YELLOW LED
2= 24V		B= 24V		H= 24V	
3= 48V		C= 48V		K= 48V	
4= 115V		D= 115V		L= 115V	
5= 230V		E= 230V		M= 230V	

THIS DRAWING CONTAINS INFORMATION THAT IS PROPRIETARY TO MOLEX ELECTRONIC TECHNOLOGIES, LLC AND SHOULD NOT BE USED WITHOUT WRITTEN PERMISSION									
DIMENSION UNITS		SCALE		CURRENT REV DESC: OBSOLETE PART NUMBERS				<b>molex</b>	
mm		NTS							
GENERAL TOLERANCES (UNLESS SPECIFIED)				EC NO: 638770		2020/03/05		E453XXXXXXXXXX	
				DRWN: RPRABHUM		2020/07/21		DIN FORM A EN 175301-803	
				CHK'D: GGA		2020/07/21		PRODUCT CUSTOMER DRAWING	
				APPR: GGA		2020/07/21			
				INITIAL REVISION:				DOCUMENT NUMBER	
				DRWN: JMARSZALEK		2012/11/27		SD-121050-006	
				APPR: MIWASIECZKO		2014/01/30		PSD 001 D	
ANGULAR TOL ± °				DRAFT WHERE APPLICABLE MUST REMAIN WITHIN DIMENSIONS		THIRD ANGLE PROJECTION		DRAWING	
						A3-SIZE		SERIES	
						121050		MATERIAL NUMBER	
						SEE SHEET 2 & 4		CUSTOMER	
						GENERAL MARKET		SHEET NUMBER	
						2 OF 10			

TABLE 2 - CABLES

Cable type	Cable code	Wires no.	Cross Section	Jacket material	Jacket color	Diameter Ø[mm]	Wire colors
I	0	3	1 mm <sup>2</sup>	PVC CEI 2022 II O.R.	Grey	7.6±0.2	BN, BU, GN/YE
A	2	2	20 AWG	PVC CSA/UL 2661	Black	5.4±0.2	BN, BU
A	2	3	20 AWG	PVC CSA/UL 2661	Black	5.6±0.2	BN, BU, GN/YE
A	2	4	20 AWG	PVC CSA/UL 2661	Black	6.2±0.25	BN, BU, BK, GN/YE
B	2	2	20 AWG	PUR CSA/UL 20668	Black	5.6±0.2	BN, BU
B	2	3	20 AWG	PUR CSA/UL 20668	Black	5.6±0.2	BN, BU, GN/YE
B	2	4	0.5 mm <sup>2</sup>	PUR CSA/UL 20668	Black	6.3±0.2	BN, BU, BK, GN/YE
D	2	3	0.5 mm <sup>2</sup>	PVC CEI 20-20	Grey	5.5+0.3/-0	BN, BU, GN/YE
I	2	2	0.5 mm <sup>2</sup>	PVC CEI 2022 II O.R.	Grey	5.5+0.3/-0	BN, BU
I	2	3	0.5 mm <sup>2</sup>	PVC CEI 2022 II O.R.	Grey	5.5+0.3/-0	BN, BU, GN/YE
I	2	4	0.5 mm <sup>2</sup>	PVC CEI 2022 II O.R.	Grey	6.5±0.2	BN, BU, BK, GN/YE
I	2	5	0.5 mm <sup>2</sup>	PVC CEI 2022 II O.R.	Grey	7.0+0.3/-0	BN, BU, BK, WH, GN/YE
N	2	2	0.5 mm <sup>2</sup>	PVC H03VV-F	Black	5.2±0.2	BN, BU
N	2	3	0.5 mm <sup>2</sup>	PVC H03VV-F	Black	5.5±0.2	BN, BU, GN/YE
N	2	4	0.5 mm <sup>2</sup>	PVC H03VV-F	Black	5.9±0.3	BN, BU, BK, GN/YE
P	2	2	0.5 mm <sup>2</sup>	PUR - BLEND	Black	5.5±0.2	BN, BU
P	2	3	0.5 mm <sup>2</sup>	PUR - BLEND	Black	5.5+0.3/-0	BN, BU, GN/YE
P	2	4	0.5 mm <sup>2</sup>	PUR - BLEND	Black	6.5±0.2	BN, BU, BK, GN/YE
P	2	5	0.5 mm <sup>2</sup>	PUR - BLEND	Black	7+0.3/-0.1	BN, BU, BK, WH, GN/YE
A	3	2	18 AWG	PVC CSA/UL 2661	Black	6.2±0.25	BN, BU
A	3	3	18 AWG	PVC CSA/UL 2661	Black	6.5±0.25	BN, BU, GN/YE
A	3	4	18 AWG	PVC CSA/UL 2661	Black	7.0+0.3/-0	BN, BU, BK, GN/YE
A	3	5	18 AWG	PVC CSA/UL 2661	Black	7.8±0.25	BN, BU, BK, WH, GN/YE
B	3	2	18 AWG	PUR CSA/UL 20668	Black	6.2±0.2	BN, BU
B	3	3	18 AWG	PUR CSA/UL 20668	Black	6.5±0.2	BN, BU, GN/YE
B	3	4	18 AWG	PUR CSA/UL 20668	Black	7±0.2	BN, BU, BK, GN/YE
B	3	5	18 AWG	PUR CSA/UL 20668	Black	7.8±0.25	BN, BU, BK, WH, GN/YE
D	3	3	0.75 mm <sup>2</sup>	PVC CEI 20-20	Grey	6.5±0.2	BN, BU, GN/YE
D	3	4	0.75 mm <sup>2</sup>	PVC CEI 20-20	Grey	7.1±0.2	BN, BU, BK, GN/YE
I	3	2	0.75 mm <sup>2</sup>	PVC CEI 2022 II O.R.	Grey	5.5±0.2	BK1, BK2
I	3	3	0.75 mm <sup>2</sup>	PVC CEI 2022 II O.R.	Grey	6.0±0.2	BK1, BK2, BK3
I	3	4	0.75 mm <sup>2</sup>	PVC CEI 2022 II O.R.	Grey	7.0±0.2	BN, BU, BK, GN/YE
N	3	2	0.75 mm <sup>2</sup>	PVC H05VV-F	Black	6.2±0.2	BN, BU
N	3	3	0.75 mm <sup>2</sup>	PVC H05VV-F	Black	6.5±0.2	BN, BU, GN/YE
N	3	4	0.75 mm <sup>2</sup>	PVC H05VV-F	Black	7.1±0.2	BN, BU, BK, GN/YE
N	3	5	0.75 mm <sup>2</sup>	PVC H05VV-F	Black	8.0+0.2/-0	BN, BU, BK, GY, GN/YE
P	3	2	0.75 mm <sup>2</sup>	PUR - BLEND	Black	6.5±0.2	BN, BU
P	3	3	0.75 mm <sup>2</sup>	PUR - BLEND	Black	6.5±0.2	BN, BU, GN/YE
P	3	4	0.75 mm <sup>2</sup>	PUR - BLEND	Black	7.0±0.2	BN, BU, BK, GN/YE

TABLE 2 - CABLES

Cable type	Cable code	Wires no.	Cross Section	Jacket material	Jacket color	Diameter Ø[mm]	Wire colors
R	3	3	0.75 mm <sup>2</sup>	TPR HAL. FREE	Black	6.5±0.2	BN, BU, GN/YE
T	3	3	0.75 mm <sup>2</sup>	PUR CSA/UL 20668	Yellow	6.5±0.2	BN, BU, GN/YE
Y	3	3	0.75 mm <sup>2</sup>	SILICONE RUBBER	Red	6.5±0.2	BN, BU, GN/YE
F	4	3	1 mm <sup>2</sup>	PVC CNOMO	Grey	7.1+0.2/-0	BK1, BK2, GN/YE
I	4	2	1 mm <sup>2</sup>	PVC CEI 2022 II O.R.	Grey	7.1+0.2/-0	BN, BU
I	4	3	1 mm <sup>2</sup>	PVC CEI 2022 II O.R.	Grey	7.1+0.2/-0	BN, BU, GN/YE
N	4	2	1 mm <sup>2</sup>	PVC H05VV-F	Black	6.5±0.2	BN, BU
N	4	3	1 mm <sup>2</sup>	PVC H05VV-F	Black	6.9±0.2	BN, BU, GN/YE
R	4	3	1 mm <sup>2</sup>	TPR HAL.FREE	Black	7.1±0.2	BN, BU, GN/YE
N	5	3	1.5 mm <sup>2</sup>	PVC H05VV-F	Black	7.9±0.2	BN, BU, GN/YE
I	6	2	0.35 mm <sup>2</sup>	PVC CEI 2011	Grey	4.8±0.2	BN, WH
I	9	4	0.75 mm <sup>2</sup>	PVC CEI 2022 II	Grey	7.3±0.2	BN, BU, BK, GN/YE

TABLE 1 - CABLES TYPE

Code	Cable types	Features	Cable type Cross section
N	PVC	Application general purpose cable which has good resistance to water, but usually poor oil resistance.	N2=0.5 mm <sup>2</sup> N3=0.75 mm <sup>2</sup> N4=1 mm <sup>2</sup>
I	CEI	Approved to IEC 332-2A, flame retardant and self extinguishing. Limited resistant to mineral oils.	I2=0.5 mm <sup>2</sup> I3=0.75 mm <sup>2</sup> I4=1 mm <sup>2</sup>
P	PUR	Offer good resistance to oil and chemicals. Can swell when constantly immersed in water.	P2=0.5 mm <sup>2</sup> P3=0.75 mm <sup>2</sup> P4=1 mm <sup>2</sup>
A	PVC CSA-UL	Approved to CSA-UL 2661, application general purpose cable which has good resistance to water, but usually poor oil resistance.	A2=20 AWG A3=18 AWG
B	PUR CSA-UL	Approved to CSA-UL 20668, very good resistance to oil and chemicals.	B2=20 AWG B3=18 AWG



THIS DRAWING CONTAINS INFORMATION THAT IS PROPRIETARY TO MOLEX ELECTRONIC TECHNOLOGIES, LLC AND SHOULD NOT BE USED WITHOUT WRITTEN PERMISSION		CURRENT REV DESC: OBSOLETE PART NUMBERS		 E453XXXXXXXXXX DIN FORM A EN 175301-803	
DIMENSION UNITS	SCALE	EC NO: 638770			
mm	NTS	DRWN: RPRABHUM 2020/03/05		PRODUCT CUSTOMER DRAWING	
GENERAL TOLERANCES (UNLESS SPECIFIED)		CHK'D: GGA 2020/07/21			
		APPR: GGA 2020/07/21		DOCUMENT NUMBER	
4 PLACES ±		INITIAL REVISION:		SD-121050-006	
3 PLACES ±		DRWN: JMARSZALEK 2012/11/27		DOC TYPE	
2 PLACES ±		APPR: MIWASIECZKO 2014/01/30		PSD	
1 PLACE ±				DOC PART	
0 PLACES ±				001	
ANGULAR TOL ± °				REVISION	
				D	
DRAFT WHERE APPLICABLE MUST REMAIN WITHIN DIMENSIONS		THIRD ANGLE PROJECTION	DRAWING	SERIES	MATERIAL NUMBER
			A3-SIZE	121050	CUSTOMER
					GENERAL MARKET
					SHEET NUMBER
					3 OF 10

TABLE 3 - PART LIST

Pos.	Molex PN:	Engineering No.:
1	1210400521	E453A3A30022000
2	1210400522	E453A3A30062000
3	<del>1210400524</del> VO	E453B3A10062000
4	1210400525	E453B3A10K22000
5	1210400526	E453B3A10K62000
6	1210400527	E453B3A30022000
7	1210400528	E453B3A30062000
8	1210400529	E453B3A50022000
9	1210400530	E453B3A50062000
10	1210400537	E453N3N10022000
11	1210400538	E453N3N10062000
12	1210400539	E453N3N30022000
13	1210400540	E453N3N30062000
14	1210400541	E453N3N50022000
15	1210400542	E453N3N50062000
16	1210400544	E453P3N10022000
17	1210400545	E453P3N10062000
18	1210400547	E453P3N30022000
19	1210400548	E453P3N30062000
20	1210400550	E453P3N50022000
21	1210400551	E453P3N50062000
22	1210400675	E453A3A50022000
23	1210400684	E453N3N10K62000
24	1210400696	E453A3A10K22000
25	1210400697	E453A3A50062000
26	1210400698	E453A3A10K62000
27	1210400796	E453N3N20062000
28	1210400833	E453A3A10022000
29	1210400864	E453B2A30022000
30	1210400937	E453N3N2002P000
31	1210400953	E453N3N1002P000
32	1210400967	E453N3N5002P000
33	1210400973	E453P3N2502P000
34	1210400974	E453P3N2002P000
35	1210400980	E453A3A15K62000
36	1210401232	W453P3N30022000
37	1210401236	W453N3N30022000
38	1210401264	E453P3N5002P000
39	1210401266	W453N3N50022000
40	1210401267	W453N3N50062000

Pos.	Molex PN:	Engineering No.:
41	1210401307	W453P3N50062000
42	<del>1210500839</del> VO	E453I3N20021Q02
43	1210500842	E453I3N30021Q02
44	1210500844	E453I3N30021Q12
45	1210500845	E453I3N30021Q62
46	1210500848	E453I3N30061Q12
47	1210500854	E453I3N50021Q12
48	1210500858	E453I3N50061Q12
49	1210500875	E453N3N50022Q02
50	1210500888	E453P2N30021Q01
51	1210500889	E453P2N30021Q02
52	1210500895	E453P2N30061Q12
53	1210501705	E453N3N30021Q02
54	1210501787	E453N3N30061Q02
55	1210501794	E453I3N10K61Q02
56	1210501823	E453P2N50061Q12
57	1210501848	E453P3N4001117H
58	1210501868	E453P2N30021Q52
59	1210501869	E453P2N50021Q52
60	1210502033	E453P3N4001118H
61	1210502131	E453I2N30021Q02
62	1210502409	E453I2N20021Q12
63	1210502410	E453I2N30021Q12
64	1210502440	E453I2N50021Q12
65	1210502446	E453I3N80021Q12
66	1210502452	E453B3A50061Q02
67	1210502453	E453B3A10K21Q02
68	1210502454	E453B3A50021Q02
69	1210502455	E453B3A30021Q02
70	1210502473	E453I3N5002RQ02
71	1210502517	E453I2N10K21Q12
72	1210502535	E453P2N10K61Q12
73	1210502557	E453I2N50021Q02
74	1210502562	E453N3N30022C44
75	1210502603	E453P3N5001118H
76	1210502668	E453I2N30021Q62
77	1210502941	W453I3N5002RQ02
78	1210502964	W453I3N2002RQ02
79	1210502966	W453A3A10K2RQ02
80	1210502972	E453N2N80011172

Pos.	Molex PN:	Engineering No.:
81	1210502979	E453P2N10K2PQ02
82	1210502980	E453P2N50K2RQ02
83	1210503016	E453B3A30063Q02
84	1210503019	E453N3N30021A1H
85	1210503035	E453N2N20061C42
86	1210503043	E453P3N3001PI7H
87	1210503107	E453A3A15021Q02
88	1210503108	E453A3A30021Q02
89	1210503109	E453A3A50021Q02
90	1210503110	E453A3A75021Q02
91	1210503111	E453A3A10K21Q02
92	1210503124	E453I2N50021Q62
93	1210503134	E453N3N05021Q12
94	1210503230	E453N3N40061C42
95	1210503249	E453P2N50021Q02
96	1210503251	E453N3N10K2RC4B
97	1210503252	E453N3N10K2RC4A
98	1210503430	E453I2N15K61Q12
99	1210503434	E453N3N25021C4H
100	2210507740	E453A2A10011000
101	2210507741	E453A2A10021171
102	2210507742	E453A2A10021172
103	2210507743	E453A2A10021173
104	2210507744	E453A2A10021174
105	2210507745	E453A2A10021175
106	2210507746	E453A2A1002117A
107	2210507747	E453A2A1002117B
108	2210507748	E453A2A1002117C
109	2210507749	E453A2A1002117D
110	2210507750	E453A2A1002117E
111	2210507751	E453A2A1002117G
112	2210507752	E453A2A1002117H
113	2210507753	E453A2A1002117K
114	2210507754	E453A2A1002117L
115	2210507755	E453A2A1002117M
116	2210507756	E453A2A10K11000
117	2210507757	E453A2A10K21171
118	2210507758	E453A2A10K21172
119	2210507759	E453A2A10K21173
120	2210507760	E453A2A10K21174

Pos.	Molex PN:	Engineering No.:
121	2210507761	E453A2A10K21175
122	2210507762	E453A2A10K2117A
123	2210507763	E453A2A10K2117B
124	2210507764	E453A2A10K2117C
125	2210507765	E453A2A10K2117D
126	2210507766	E453A2A10K2117E
127	2210507767	E453A2A10K2117G
128	2210507768	E453A2A10K2117H
129	2210507769	E453A2A10K2117K
130	2210507770	E453A2A10K2117L
131	2210507771	E453A2A10K2117M
132	2210507772	E453A2A15011000
133	2210507773	E453A2A15021171
134	2210507774	E453A2A15021172
135	2210507775	E453A2A15021173
136	2210507776	E453A2A15021174
137	2210507777	E453A2A15021175
138	2210507778	E453A2A1502117A
139	2210507779	E453A2A1502117B
140	2210507780	E453A2A1502117C
141	2210507781	E453A2A1502117D
142	2210507782	E453A2A1502117E
143	2210507783	E453A2A1502117G
144	2210507784	E453A2A1502117H
145	2210507785	E453A2A1502117K
146	2210507786	E453A2A1502117L
147	2210507787	E453A2A1502117M
148	2210507788	E453A2A20011000
149	2210507789	E453A2A20021171
150	2210507790	E453A2A20021172
151	2210507791	E453A2A20021173
152	2210507792	E453A2A20021174
153	2210507793	E453A2A20021175
154	2210507794	E453A2A2002117A
155	2210507795	E453A2A2002117B
156	2210507796	E453A2A2002117C
157	2210507797	E453A2A2002117D
158	2210507798	E453A2A2002117E
159	2210507799	E453A2A2002117G
160	2210507800	E453A2A2002117H

Pos.	Molex PN:	Engineering No.:
161	2210507801	E453A2A2002117K
162	2210507802	E453A2A2002117L
163	2210507803	E453A2A2002117M
164	2210507804	E453A2A30011000
165	2210507805	E453A2A30021171
166	2210507806	E453A2A30021172
167	2210507807	E453A2A30021173
168	2210507808	E453A2A30021174
169	2210507809	E453A2A30021175
170	2210507810	E453A2A3002117A
171	2210507811	E453A2A3002117B
172	2210507812	E453A2A3002117C
173	2210507813	E453A2A3002117D
174	2210507814	E453A2A3002117E
175	2210507815	E453A2A3002117G
176	2210507816	E453A2A3002117H
177	2210507817	E453A2A3002117K
178	2210507818	E453A2A3002117L
179	2210507819	E453A2A3002117M
180	2210507820	E453A2A50011000
181	2210507821	E453A2A50021171
182	2210507822	E453A2A50021172
183	2210507823	E453A2A50021173
184	2210507824	E453A2A50021174
185	2210507825	E453A2A50021175
186	2210507826	E453A2A5002117A
187	2210507827	E453A2A5002117B
188	2210507828	E453A2A5002117C
189	2210507829	E453A2A5002117D
190	2210507830	E453A2A5002117E
191	2210507831	E453A2A5002117G
192	2210507832	E453A2A5002117H
193	2210507833	E453A2A5002117K
194	2210507834	E453A2A5002117L
195	2210507835	E453A2A5002117M
196	2210507836	E453A3A10011000
197	2210507837	E453A3A10021171
198	2210507838	E453A3A10021172
199	2210507839	E453A3A10021173
200	2210507840	E453A3A10021174

THIS DRAWING CONTAINS INFORMATION THAT IS PROPRIETARY TO MOLEX ELECTRONIC TECHNOLOGIES, LLC AND SHOULD NOT BE USED WITHOUT WRITTEN PERMISSION		CURRENT REV DESC: OBSOLETE PART NUMBERS		 <p>E453XXXXXXXXXX DIN FORM A EN 175301-803</p>			
DIMENSION UNITS	SCALE						
mm	NTS			EC NO: 638770 DRWN: RPRABHUM CHK'D: GGA APPR: GGA 2020/03/05 2020/07/21 2020/07/21			
GENERAL TOLERANCES (UNLESS SPECIFIED)		MM	INCH				
4 PLACES	±	±	±				
3 PLACES	±	±	±				
2 PLACES	±	±	±				
1 PLACE	±	±	±	INITIAL REVISION: DRWN: JMARSZALEK APPR: MIWASIECZKO 2012/11/27 2014/01/30			
0 PLACES	±	±	±				
ANGULAR TOL	± °			DOCUMENT NUMBER	DOC TYPE   DOC PART   REVISION		
DRAFT WHERE APPLICABLE MUST REMAIN WITHIN DIMENSIONS		THIRD ANGLE PROJECTION	DRAWING	SERIES	MATERIAL NUMBER	CUSTOMER	SHEET NUMBER
			A3-SIZE	121050	SEE SHEET 2 & 4	GENERAL MARKET	4 OF 10



TABLE 3 - PART LIST

Pos.	Molex PN:	Engineering No.:	Pos.	Molex PN:	Engineering No.:	Pos.	Molex PN:	Engineering No.:	Pos.	Molex PN:	Engineering No.:	Pos.	Molex PN:	Engineering No.:
201	2210507841	E453A3A10021I75	241	2210507881	E453A3A15021I7K	281	2210507921	E453A3A50021I75	321	2210507961	E453B2A10K21I7K	361	2210508001	E453B2A30021I75
202	2210507842	E453A3A10021I7A	242	2210507882	E453A3A15021I7L	282	2210507922	E453A3A50021I7A	322	2210507962	E453B2A10K21I7L	362	2210508002	E453B2A30021I7A
203	2210507843	E453A3A10021I7B	243	2210507883	E453A3A15021I7M	283	2210507923	E453A3A50021I7B	323	2210507963	E453B2A10K21I7M	363	2210508003	E453B2A30021I7B
204	2210507844	E453A3A10021I7C	244	2210507884	E453A3A20011000	284	2210507924	E453A3A50021I7C	324	2210507964	E453B2A15011000	364	2210508004	E453B2A30021I7C
205	2210507845	E453A3A10021I7D	245	2210507885	E453A3A20021I71	285	2210507925	E453A3A50021I7D	325	2210507965	E453B2A15021I71	365	2210508005	E453B2A30021I7D
206	2210507846	E453A3A10021I7E	246	2210507886	E453A3A20021I72	286	2210507926	E453A3A50021I7E	326	2210507966	E453B2A15021I72	366	2210508006	E453B2A30021I7E
207	2210507847	E453A3A10021I7G	247	2210507887	E453A3A20021I73	287	2210507927	E453A3A50021I7G	327	2210507967	E453B2A15021I73	367	2210508007	E453B2A30021I7G
208	2210507848	E453A3A10021I7H	248	2210507888	E453A3A20021I74	288	2210507928	E453A3A50021I7H	328	2210507968	E453B2A15021I74	368	2210508008	E453B2A30021I7H
209	2210507849	E453A3A10021I7K	249	2210507889	E453A3A20021I75	289	2210507929	E453A3A50021I7K	329	2210507969	E453B2A15021I75	369	2210508009	E453B2A30021I7K
210	2210507850	E453A3A10021I7L	250	2210507890	E453A3A20021I7A	290	2210507930	E453A3A50021I7L	330	2210507970	E453B2A15021I7A	370	2210508010	E453B2A30021I7L
211	2210507851	E453A3A10021I7M	251	2210507891	E453A3A20021I7B	291	2210507931	E453A3A50021I7M	331	2210507971	E453B2A15021I7B	371	2210508011	E453B2A30021I7M
212	2210507852	E453A3A10K11000	252	2210507892	E453A3A20021I7C	292	2210507932	E453B2A10011000	332	2210507972	E453B2A15021I7C	372	2210508012	E453B2A50011000
213	2210507853	E453A3A10K21I71	253	2210507893	E453A3A20021I7D	293	2210507933	E453B2A10021I71	333	2210507973	E453B2A15021I7D	373	2210508013	E453B2A50021I71
214	2210507854	E453A3A10K21I72	254	2210507894	E453A3A20021I7E	294	2210507934	E453B2A10021I72	334	2210507974	E453B2A15021I7E	374	2210508014	E453B2A50021I72
215	2210507855	E453A3A10K21I73	255	2210507895	E453A3A20021I7G	295	2210507935	E453B2A10021I73	335	2210507975	E453B2A15021I7G	375	2210508015	E453B2A50021I73
216	2210507856	E453A3A10K21I74	256	2210507896	E453A3A20021I7H	296	2210507936	E453B2A10021I74	336	2210507976	E453B2A15021I7H	376	2210508016	E453B2A50021I74
217	2210507857	E453A3A10K21I75	257	2210507897	E453A3A20021I7K	297	2210507937	E453B2A10021I75	337	2210507977	E453B2A15021I7K	377	2210508017	E453B2A50021I75
218	2210507858	E453A3A10K21I7A	258	2210507898	E453A3A20021I7L	298	2210507938	E453B2A10021I7A	338	2210507978	E453B2A15021I7L	378	2210508018	E453B2A50021I7A
219	2210507859	E453A3A10K21I7B	259	2210507899	E453A3A20021I7M	299	2210507939	E453B2A10021I7B	339	2210507979	E453B2A15021I7M	379	2210508019	E453B2A50021I7B
220	2210507860	E453A3A10K21I7C	260	2210507900	E453A3A30011000	300	2210507940	E453B2A10021I7C	340	2210507980	E453B2A20011000	380	2210508020	E453B2A50021I7C
221	2210507861	E453A3A10K21I7D	261	2210507901	E453A3A30021I71	301	2210507941	E453B2A10021I7D	341	2210507981	E453B2A20021I71	381	2210508021	E453B2A50021I7D
222	2210507862	E453A3A10K21I7E	262	2210507902	E453A3A30021I72	302	2210507942	E453B2A10021I7E	342	2210507982	E453B2A20021I72	382	2210508022	E453B2A50021I7E
223	2210507863	E453A3A10K21I7G	263	2210507903	E453A3A30021I73	303	2210507943	E453B2A10021I7G	343	2210507983	E453B2A20021I73	383	2210508023	E453B2A50021I7G
224	2210507864	E453A3A10K21I7H	264	2210507904	E453A3A30021I74	304	2210507944	E453B2A10021I7H	344	2210507984	E453B2A20021I74	384	2210508024	E453B2A50021I7H
225	2210507865	E453A3A10K21I7K	265	2210507905	E453A3A30021I75	305	2210507945	E453B2A10021I7K	345	2210507985	E453B2A20021I75	385	2210508025	E453B2A50021I7K
226	2210507866	E453A3A10K21I7L	266	2210507906	E453A3A30021I7A	306	2210507946	E453B2A10021I7L	346	2210507986	E453B2A20021I7A	386	2210508026	E453B2A50021I7L
227	2210507867	E453A3A10K21I7M	267	2210507907	E453A3A30021I7B	307	2210507947	E453B2A10021I7M	347	2210507987	E453B2A20021I7B	387	2210508027	E453B2A50021I7M
228	2210507868	E453A3A15011000	268	2210507908	E453A3A30021I7C	308	2210507948	E453B2A10K11000	348	2210507988	E453B2A20021I7C	388	2210508028	E453B3A10011000
229	2210507869	E453A3A15021I71	269	2210507909	E453A3A30021I7D	309	2210507949	E453B2A10K21I71	349	2210507989	E453B2A20021I7D	389	2210508029	E453B3A10021I71
230	2210507870	E453A3A15021I72	270	2210507910	E453A3A30021I7E	310	2210507950	E453B2A10K21I72	350	2210507990	E453B2A20021I7E	390	2210508030	E453B3A10021I72
231	2210507871	E453A3A15021I73	271	2210507911	E453A3A30021I7G	311	2210507951	E453B2A10K21I73	351	2210507991	E453B2A20021I7G	391	2210508031	E453B3A10021I73
232	2210507872	E453A3A15021I74	272	2210507912	E453A3A30021I7H	312	2210507952	E453B2A10K21I74	352	2210507992	E453B2A20021I7H	392	2210508032	E453B3A10021I74
233	2210507873	E453A3A15021I75	273	2210507913	E453A3A30021I7K	313	2210507953	E453B2A10K21I75	353	2210507993	E453B2A20021I7K	393	2210508033	E453B3A10021I75
234	2210507874	E453A3A15021I7A	274	2210507914	E453A3A30021I7L	314	2210507954	E453B2A10K21I7A	354	2210507994	E453B2A20021I7L	394	2210508034	E453B3A10021I7A
235	2210507875	E453A3A15021I7B	275	2210507915	E453A3A30021I7M	315	2210507955	E453B2A10K21I7B	355	2210507995	E453B2A20021I7M	395	2210508035	E453B3A10021I7B
236	2210507876	E453A3A15021I7C	276	2210507916	E453A3A50011000	316	2210507956	E453B2A10K21I7C	356	2210507996	E453B2A30011000	396	2210508036	E453B3A10021I7C
237	2210507877	E453A3A15021I7D	277	2210507917	E453A3A50021I71	317	2210507957	E453B2A10K21I7D	357	2210507997	E453B2A30021I71	397	2210508037	E453B3A10021I7D
238	2210507878	E453A3A15021I7E	278	2210507918	E453A3A50021I72	318	2210507958	E453B2A10K21I7E	358	2210507998	E453B2A30021I72	398	2210508038	E453B3A10021I7E
239	2210507879	E453A3A15021I7G	279	2210507919	E453A3A50021I73	319	2210507959	E453B2A10K21I7G	359	2210507999	E453B2A30021I73	399	2210508039	E453B3A10021I7G
240	2210507880	E453A3A15021I7H	280	2210507920	E453A3A50021I74	320	2210507960	E453B2A10K21I7H	360	2210508000	E453B2A30021I74	400	2210508040	E453B3A10021I7H

THIS DRAWING CONTAINS INFORMATION THAT IS PROPRIETARY TO MOLEX ELECTRONIC TECHNOLOGIES, LLC AND SHOULD NOT BE USED WITHOUT WRITTEN PERMISSION																															
<table border="1"> <tr> <th>DIMENSION UNITS</th> <th>SCALE</th> </tr> <tr> <td>mm</td> <td>NTS</td> </tr> <tr> <td colspan="2">GENERAL TOLERANCES (UNLESS SPECIFIED)</td> </tr> <tr> <td colspan="2"> <table border="1"> <tr> <td></td> <td>MM</td> <td>INCH</td> </tr> <tr> <td>4 PLACES</td> <td>±</td> <td>±</td> </tr> <tr> <td>3 PLACES</td> <td>±</td> <td>±</td> </tr> <tr> <td>2 PLACES</td> <td>±</td> <td>±</td> </tr> <tr> <td>1 PLACE</td> <td>±</td> <td>±</td> </tr> <tr> <td>0 PLACES</td> <td>±</td> <td>±</td> </tr> </table> </td> </tr> <tr> <td colspan="2">ANGULAR TOL ± °</td> </tr> <tr> <td colspan="2">DRAFT WHERE APPLICABLE MUST REMAIN WITHIN DIMENSIONS</td> </tr> </table>	DIMENSION UNITS	SCALE	mm	NTS	GENERAL TOLERANCES (UNLESS SPECIFIED)		<table border="1"> <tr> <td></td> <td>MM</td> <td>INCH</td> </tr> <tr> <td>4 PLACES</td> <td>±</td> <td>±</td> </tr> <tr> <td>3 PLACES</td> <td>±</td> <td>±</td> </tr> <tr> <td>2 PLACES</td> <td>±</td> <td>±</td> </tr> <tr> <td>1 PLACE</td> <td>±</td> <td>±</td> </tr> <tr> <td>0 PLACES</td> <td>±</td> <td>±</td> </tr> </table>			MM	INCH	4 PLACES	±	±	3 PLACES	±	±	2 PLACES	±	±	1 PLACE	±	±	0 PLACES	±	±	ANGULAR TOL ± °		DRAFT WHERE APPLICABLE MUST REMAIN WITHIN DIMENSIONS		<p>CURRENT REV DESC: OBSOLETE PART NUMBERS</p>  <p>E453XXXXXXXXXX DIN FORM A EN 175301-803</p> <p>EC NO: 638770 DRWN: RPRABHUM 2020/03/05 CHK'D: GGA 2020/07/21 APPR: GGA 2020/07/21</p> <p>INITIAL REVISION: DRWN: JMARSZALEK 2012/11/27 APPR: MIWASIECZKO 2014/01/30</p> <p>DRAWING SERIES A3-SIZE 121050</p>
DIMENSION UNITS	SCALE																														
mm	NTS																														
GENERAL TOLERANCES (UNLESS SPECIFIED)																															
<table border="1"> <tr> <td></td> <td>MM</td> <td>INCH</td> </tr> <tr> <td>4 PLACES</td> <td>±</td> <td>±</td> </tr> <tr> <td>3 PLACES</td> <td>±</td> <td>±</td> </tr> <tr> <td>2 PLACES</td> <td>±</td> <td>±</td> </tr> <tr> <td>1 PLACE</td> <td>±</td> <td>±</td> </tr> <tr> <td>0 PLACES</td> <td>±</td> <td>±</td> </tr> </table>			MM	INCH	4 PLACES	±	±	3 PLACES	±	±	2 PLACES	±	±	1 PLACE	±	±	0 PLACES	±	±												
	MM	INCH																													
4 PLACES	±	±																													
3 PLACES	±	±																													
2 PLACES	±	±																													
1 PLACE	±	±																													
0 PLACES	±	±																													
ANGULAR TOL ± °																															
DRAFT WHERE APPLICABLE MUST REMAIN WITHIN DIMENSIONS																															
<table border="1"> <tr> <th>DOCUMENT NUMBER</th> <th>DOC TYPE</th> <th>DOC PART</th> <th>REVISION</th> </tr> <tr> <td>SD-121050-006</td> <td>PSD</td> <td>001</td> <td>D</td> </tr> <tr> <th>MATERIAL NUMBER</th> <th>CUSTOMER</th> <th colspan="2">SHEET NUMBER</th> </tr> <tr> <td>SEE SHEET 2 &amp; 4</td> <td>GENERAL MARKET</td> <td colspan="2">5 OF 10</td> </tr> </table>	DOCUMENT NUMBER	DOC TYPE	DOC PART	REVISION	SD-121050-006	PSD	001	D	MATERIAL NUMBER	CUSTOMER	SHEET NUMBER		SEE SHEET 2 & 4	GENERAL MARKET	5 OF 10		<p>PRODUCT CUSTOMER DRAWING</p>														
DOCUMENT NUMBER	DOC TYPE	DOC PART	REVISION																												
SD-121050-006	PSD	001	D																												
MATERIAL NUMBER	CUSTOMER	SHEET NUMBER																													
SEE SHEET 2 & 4	GENERAL MARKET	5 OF 10																													

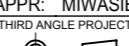
TABLE 3 - PART LIST

Pos.	Molex PN:	Engineering No.:
401	2210508041	E453B3A10021I7K
402	2210508042	E453B3A10021I7L
403	2210508043	E453B3A10021I7M
404	2210508044	E453B3A10K11000
405	2210508045	E453B3A10K21I71
406	2210508046	E453B3A10K21I72
407	2210508047	E453B3A10K21I73
408	2210508048	E453B3A10K21I74
409	2210508049	E453B3A10K21I75
410	2210508050	E453B3A10K21I7A
411	2210508051	E453B3A10K21I7B
412	2210508052	E453B3A10K21I7C
413	2210508053	E453B3A10K21I7D
414	2210508054	E453B3A10K21I7E
415	2210508055	E453B3A10K21I7G
416	2210508056	E453B3A10K21I7H
417	2210508057	E453B3A10K21I7K
418	2210508058	E453B3A10K21I7L
419	2210508059	E453B3A10K21I7M
420	2210508060	E453B3A15011000
421	2210508061	E453B3A15021I71
422	2210508062	E453B3A15021I72
423	2210508063	E453B3A15021I73
424	2210508064	E453B3A15021I74
425	2210508065	E453B3A15021I75
426	2210508066	E453B3A15021I7A
427	2210508067	E453B3A15021I7B
428	2210508068	E453B3A15021I7C
429	2210508069	E453B3A15021I7D
430	2210508070	E453B3A15021I7E
431	2210508071	E453B3A15021I7G
432	2210508072	E453B3A15021I7H
433	2210508073	E453B3A15021I7K
434	2210508074	E453B3A15021I7L
435	2210508075	E453B3A15021I7M
436	2210508076	E453B3A20011000
437	2210508077	E453B3A20021I71
438	2210508078	E453B3A20021I72
439	2210508079	E453B3A20021I73
440	2210508080	E453B3A20021I74

Pos.	Molex PN:	Engineering No.:
441	2210508081	E453B3A20021I75
442	2210508082	E453B3A20021I7A
443	2210508083	E453B3A20021I7B
444	2210508084	E453B3A20021I7C
445	2210508085	E453B3A20021I7D
446	2210508086	E453B3A20021I7E
447	2210508087	E453B3A20021I7G
448	2210508088	E453B3A20021I7H
449	2210508089	E453B3A20021I7K
450	2210508090	E453B3A20021I7L
451	2210508091	E453B3A20021I7M
452	2210508092	E453B3A30011000
453	2210508093	E453B3A30021I71
454	2210508094	E453B3A30021I72
455	2210508095	E453B3A30021I73
456	2210508096	E453B3A30021I74
457	2210508097	E453B3A30021I75
458	2210508098	E453B3A30021I7A
459	2210508099	E453B3A30021I7B
460	2210508100	E453B3A30021I7C
461	2210508101	E453B3A30021I7D
462	2210508102	E453B3A30021I7E
463	2210508103	E453B3A30021I7G
464	2210508104	E453B3A30021I7H
465	2210508105	E453B3A30021I7K
466	2210508106	E453B3A30021I7L
467	2210508107	E453B3A30021I7M
468	2210508108	E453B3A50011000
469	2210508109	E453B3A50021I71
470	2210508110	E453B3A50021I72
471	2210508111	E453B3A50021I73
472	2210508112	E453B3A50021I74
473	2210508113	E453B3A50021I75
474	2210508114	E453B3A50021I7A
475	2210508115	E453B3A50021I7B
476	2210508116	E453B3A50021I7C
477	2210508117	E453B3A50021I7D
478	2210508118	E453B3A50021I7E
479	2210508119	E453B3A50021I7G
480	2210508120	E453B3A50021I7H

Pos.	Molex PN:	Engineering No.:
481	2210508121	E453B3A50021I7K
482	2210508122	E453B3A50021I7L
483	2210508123	E453B3A50021I7M
484	2210508124	E453I2N10011000
485	2210508125	E453I2N10021I71
486	2210508126	E453I2N10021I72
487	2210508127	E453I2N10021I73
488	2210508128	E453I2N10021I74
489	2210508129	E453I2N10021I75
490	2210508130	E453I2N10021I7A
491	2210508131	E453I2N10021I7B
492	2210508132	E453I2N10021I7C
493	2210508133	E453I2N10021I7D
494	2210508134	E453I2N10021I7E
495	2210508135	E453I2N10021I7G
496	2210508136	E453I2N10021I7H
497	2210508137	E453I2N10021I7K
498	2210508138	E453I2N10021I7L
499	2210508139	E453I2N10021I7M
500	2210508140	E453I2N10021Q01
501	2210508141	E453I2N10021Q02
502	2210508142	E453I2N10021Q03
503	2210508143	E453I2N10021Q04
504	2210508144	E453I2N10021Q05
505	2210508145	E453I2N10021Q0A
506	2210508146	E453I2N10021Q0B
507	2210508147	E453I2N10021Q0C
508	2210508148	E453I2N10021Q0D
509	2210508149	E453I2N10021Q0E
510	2210508150	E453I2N10021Q0G
511	2210508151	E453I2N10021Q0H
512	2210508152	E453I2N10021Q0K
513	2210508153	E453I2N10021Q0L
514	2210508154	E453I2N10021Q0M
515	2210508155	E453I2N10K11000
516	2210508156	E453I2N10K21I71
517	2210508157	E453I2N10K21I72
518	2210508158	E453I2N10K21I73
519	2210508159	E453I2N10K21I74
520	2210508160	E453I2N10K21I75

Pos.	Molex PN:	Engineering No.:
521	2210508161	E453I2N10K21I7A
522	2210508162	E453I2N10K21I7B
523	2210508163	E453I2N10K21I7C
524	2210508164	E453I2N10K21I7D
525	2210508165	E453I2N10K21I7E
526	2210508166	E453I2N10K21I7G
527	2210508167	E453I2N10K21I7H
528	2210508168	E453I2N10K21I7K
529	2210508169	E453I2N10K21I7L
530	2210508170	E453I2N10K21I7M
531	2210508171	E453I2N10K21Q01
532	2210508172	E453I2N10K21Q02
533	2210508173	E453I2N10K21Q03
534	2210508174	E453I2N10K21Q04
535	2210508175	E453I2N10K21Q05
536	2210508176	E453I2N10K21Q0A
537	2210508177	E453I2N10K21Q0B
538	2210508178	E453I2N10K21Q0C
539	2210508179	E453I2N10K21Q0D
540	2210508180	E453I2N10K21Q0E
541	2210508181	E453I2N10K21Q0G
542	2210508182	E453I2N10K21Q0H
543	2210508183	E453I2N10K21Q0K
544	2210508184	E453I2N10K21Q0L
545	2210508185	E453I2N10K21Q0M
546	2210508186	E453I2N15011000
547	2210508187	E453I2N15021I71
548	2210508188	E453I2N15021I72
549	2210508189	E453I2N15021I73
550	2210508190	E453I2N15021I74
551	2210508191	E453I2N15021I75
552	2210508192	E453I2N15021I7A
553	2210508193	E453I2N15021I7B
554	2210508194	E453I2N15021I7C
555	2210508195	E453I2N15021I7D
556	2210508196	E453I2N15021I7E
557	2210508197	E453I2N15021I7G
558	2210508198	E453I2N15021I7H
559	2210508199	E453I2N15021I7K
560	2210508200	E453I2N15021I7L

Pos.	Molex PN:	Engineering No.:
561	2210508201	E453I2N15021I7M
562	2210508202	E453I2N15021Q01
563	2210508203	E453I2N15021Q02
564	2210508204	E453I2N15021Q03
565	2210508205	E453I2N15021Q04
566	2210508206	E453I2N15021Q05
567	2210508207	E453I2N15021Q0A
568	2210508208	E453I2N15021Q0B
569	2210508209	E453I2N15021Q0C
570	2210508210	E453I2N15021Q0D
571	2210508211	E453I2N15021Q0E
572	2210508212	E453I2N15021Q0G
573	2210508213	E453I2N15021Q0H
574	2210508214	E453I2N15021Q0K
575	2210508215	E453I2N15021Q0L
576	2210508216	E453I2N15021Q0M
577	2210508217	E453I2N20011000
578	2210508218	E453I2N20021I71
579	2210508219	E453I2N20021I72
580	2210508220	E453I2N20021I73
581	2210508221	E453I2N20021I74
582	2210508222	E453I2N20021I75
583	2210508223	E453I2N20021I7A
584	2210508224	E453I2N20021I7B
585	2210508225	E453I2N20021I7C
586	2210508226	E453I2N20021I7D
587	2210508227	E453I2N20021I7E
588	2210508228	E453I2N20021I7G
589	2210508229	E453I2N20021I7H
590	2210508230	E453I2N20021I7K
591	2210508231	E453I2N20021I7L
592	2210508232	E453I2N20021I7M
593	2210508233	E453I2N20021Q01
594	2210508234	E453I2N20021Q02
595	2210508235	E453I2N20021Q03
596	2210508236	E453I2N20021Q04
597	2210508237	E453I2N20021Q05
598	2210508238	E453I2N20021Q0A
599	2210508239	E453I2N20021Q0B
600	2210508240	E453I2N20021Q0C

THIS DRAWING CONTAINS INFORMATION THAT IS PROPRIETARY TO MOLEX ELECTRONIC TECHNOLOGIES, LLC AND SHOULD NOT BE USED WITHOUT WRITTEN PERMISSION		CURRENT REV DESC: OBSOLETE PART NUMBERS																								
DIMENSION UNITS: <b>mm</b>   SCALE: <b>NTS</b>		GENERAL TOLERANCES (UNLESS SPECIFIED) <table border="1"> <tr><td></td><td>MM</td><td>INCH</td></tr> <tr><td>4 PLACES</td><td>±</td><td>±</td></tr> <tr><td>3 PLACES</td><td>±</td><td>±</td></tr> <tr><td>2 PLACES</td><td>±</td><td>±</td></tr> <tr><td>1 PLACE</td><td>±</td><td>±</td></tr> <tr><td>0 PLACES</td><td>±</td><td>±</td></tr> </table>						MM	INCH	4 PLACES	±	±	3 PLACES	±	±	2 PLACES	±	±	1 PLACE	±	±	0 PLACES	±	±	EC NO: 638770 DRWN: RPRABHUM 2020/03/05 CHK'D: GGA 2020/07/21 APPR: GGA 2020/07/21	
	MM	INCH																								
4 PLACES	±	±																								
3 PLACES	±	±																								
2 PLACES	±	±																								
1 PLACE	±	±																								
0 PLACES	±	±																								
DRAFT WHERE APPLICABLE MUST REMAIN WITHIN DIMENSIONS		THIRD ANGLE PROJECTION                                  DRAWING: <b>A3-SIZE</b>   SERIES: <b>121050</b>																								
DOCUMENT STATUS: <b>P1</b>   RELEASE DATE: <b>2020/07/21 04:42:58</b>		INITIAL REVISION: DRWN: JMARSZALEK 2012/11/27 APPR: MIWASIECZKO 2014/01/30		PRODUCT CUSTOMER DRAWING																						
		DOCUMENT NUMBER: <b>SD-121050-006</b>   DOC TYPE: <b>PSD</b>   DOC PART: <b>001</b>   REVISION: <b>D</b>		MATERIAL NUMBER: <b>SEE SHEET 2 &amp; 4</b>   CUSTOMER: <b>GENERAL MARKET</b>   SHEET NUMBER: <b>6 OF 10</b>																						



**TABLE 3 - PART LIST**

Pos.	Molex PN:	Engineering No.:
801	2210508441	E453I3N30021I7E
802	2210508442	E453I3N30021I7G
803	2210508443	E453I3N30021I7H
804	2210508444	E453I3N30021I7K
805	2210508445	E453I3N30021I7L
806	2210508446	E453I3N30021I7M
807	2210508447	E453I3N30021Q01
808	2210508448	E453I3N30021Q03
809	2210508449	E453I3N30021Q04
810	2210508450	E453I3N30021Q05
811	2210508451	E453I3N30021Q0A
812	2210508452	E453I3N30021Q0B
813	2210508453	E453I3N30021Q0C
814	2210508454	E453I3N30021Q0D
815	2210508455	E453I3N30021Q0E
816	2210508456	E453I3N30021Q0G
817	2210508457	E453I3N30021Q0H
818	2210508458	E453I3N30021Q0K
819	2210508459	E453I3N30021Q0L
820	2210508460	E453I3N30021Q0M
821	2210508461	E453I3N50011000
822	2210508462	E453I3N50021I71
823	2210508463	E453I3N50021I72
824	2210508464	E453I3N50021I73
825	2210508465	E453I3N50021I74
826	2210508466	E453I3N50021I75
827	2210508467	E453I3N50021I7A
828	2210508468	E453I3N50021I7B
829	2210508469	E453I3N50021I7C
830	2210508470	E453I3N50021I7D
831	2210508471	E453I3N50021I7E
832	2210508472	E453I3N50021I7G
833	2210508473	E453I3N50021I7H
834	2210508474	E453I3N50021I7K
835	2210508475	E453I3N50021I7L
836	2210508476	E453I3N50021I7M
837	2210508477	E453I3N50021Q01
838	<del>2210508478</del> VO	E453I3N50021Q02
839	2210508479	E453I3N50021Q03
840	2210508480	E453I3N50021Q04

Pos.	Molex PN:	Engineering No.:
841	2210508481	E453I3N50021Q05
842	2210508482	E453I3N50021Q0A
843	2210508483	E453I3N50021Q0B
844	2210508484	E453I3N50021Q0C
845	2210508485	E453I3N50021Q0D
846	2210508486	E453I3N50021Q0E
847	2210508487	E453I3N50021Q0G
848	2210508488	E453I3N50021Q0H
849	2210508489	E453I3N50021Q0K
850	2210508490	E453I3N50021Q0L
851	2210508491	E453I3N50021Q0M
852	2210508492	E453N2N10011000
853	2210508493	E453N2N10021I71
854	2210508494	E453N2N10021I72
855	2210508495	E453N2N10021I73
856	2210508496	E453N2N10021I74
857	2210508497	E453N2N10021I75
858	2210508498	E453N2N10021I7A
859	2210508499	E453N2N10021I7B
860	2210508500	E453N2N10021I7C
861	2210508501	E453N2N10021I7D
862	2210508502	E453N2N10021I7E
863	2210508503	E453N2N10021I7G
864	2210508504	E453N2N10021I7H
865	2210508505	E453N2N10021I7K
866	2210508506	E453N2N10021I7L
867	2210508507	E453N2N10021I7M
868	2210508508	E453N2N10K11000
869	2210508509	E453N2N10K21I71
870	2210508510	E453N2N10K21I72
871	2210508511	E453N2N10K21I73
872	2210508512	E453N2N10K21I74
873	2210508513	E453N2N10K21I75
874	2210508514	E453N2N10K21I7A
875	2210508515	E453N2N10K21I7B
876	2210508516	E453N2N10K21I7C
877	2210508517	E453N2N10K21I7D
878	2210508518	E453N2N10K21I7E
879	2210508519	E453N2N10K21I7G
880	2210508520	E453N2N10K21I7H

Pos.	Molex PN:	Engineering No.:
881	2210508521	E453N2N10K21I7K
882	2210508522	E453N2N10K21I7L
883	2210508523	E453N2N10K21I7M
884	2210508524	E453N2N15011000
885	2210508525	E453N2N15021I71
886	2210508526	E453N2N15021I72
887	2210508527	E453N2N15021I73
888	2210508528	E453N2N15021I74
889	2210508529	E453N2N15021I75
890	2210508530	E453N2N15021I7A
891	2210508531	E453N2N15021I7B
892	2210508532	E453N2N15021I7C
893	2210508533	E453N2N15021I7D
894	2210508534	E453N2N15021I7E
895	2210508535	E453N2N15021I7G
896	2210508536	E453N2N15021I7H
897	2210508537	E453N2N15021I7K
898	2210508538	E453N2N15021I7L
899	2210508539	E453N2N15021I7M
900	2210508540	E453N2N20011000
901	2210508541	E453N2N20021I71
902	2210508542	E453N2N20021I72
903	2210508543	E453N2N20021I73
904	2210508544	E453N2N20021I74
905	2210508545	E453N2N20021I75
906	2210508546	E453N2N20021I7A
907	2210508547	E453N2N20021I7B
908	2210508548	E453N2N20021I7C
909	2210508549	E453N2N20021I7D
910	2210508550	E453N2N20021I7E
911	2210508551	E453N2N20021I7G
912	2210508552	E453N2N20021I7H
913	2210508553	E453N2N20021I7K
914	2210508554	E453N2N20021I7L
915	2210508555	E453N2N20021I7M
916	2210508556	E453N2N30011000
917	2210508557	E453N2N30021I71
918	2210508558	E453N2N30021I72
919	2210508559	E453N2N30021I73
920	2210508560	E453N2N30021I74

Pos.	Molex PN:	Engineering No.:
921	2210508561	E453N2N30021I75
922	2210508562	E453N2N30021I7A
923	2210508563	E453N2N30021I7B
924	2210508564	E453N2N30021I7C
925	2210508565	E453N2N30021I7D
926	2210508566	E453N2N30021I7E
927	2210508567	E453N2N30021I7G
928	2210508568	E453N2N30021I7H
929	2210508569	E453N2N30021I7K
930	2210508570	E453N2N30021I7L
931	2210508571	E453N2N30021I7M
932	2210508572	E453N2N50011000
933	2210508573	E453N2N50021I71
934	2210508574	E453N2N50021I72
935	2210508575	E453N2N50021I73
936	2210508576	E453N2N50021I74
937	2210508577	E453N2N50021I75
938	2210508578	E453N2N50021I7A
939	2210508579	E453N2N50021I7B
940	2210508580	E453N2N50021I7C
941	2210508581	E453N2N50021I7D
942	2210508582	E453N2N50021I7E
943	2210508583	E453N2N50021I7G
944	2210508584	E453N2N50021I7H
945	2210508585	E453N2N50021I7K
946	2210508586	E453N2N50021I7L
947	2210508587	E453N2N50021I7M
948	2210508588	E453N3N10011000
949	2210508589	E453N3N10021I71
950	2210508590	E453N3N10021I72
951	2210508591	E453N3N10021I73
952	2210508592	E453N3N10021I74
953	2210508593	E453N3N10021I75
954	2210508594	E453N3N10021I7A
955	2210508595	E453N3N10021I7B
956	2210508596	E453N3N10021I7C
957	2210508597	E453N3N10021I7D
958	2210508598	E453N3N10021I7E
959	2210508599	E453N3N10021I7G
960	2210508600	E453N3N10021I7H

Pos.	Molex PN:	Engineering No.:
961	2210508601	E453N3N10021I7K
962	2210508602	E453N3N10021I7L
963	2210508603	E453N3N10021I7M
964	2210508604	E453N3N10021Q01
965	2210508605	E453N3N10021Q02
966	2210508606	E453N3N10021Q03
967	2210508607	E453N3N10021Q04
968	2210508608	E453N3N10021Q05
969	2210508609	E453N3N10021Q0A
970	2210508610	E453N3N10021Q0B
971	2210508611	E453N3N10021Q0C
972	2210508612	E453N3N10021Q0D
973	2210508613	E453N3N10021Q0E
974	2210508614	E453N3N10021Q0G
975	2210508615	E453N3N10021Q0H
976	2210508616	E453N3N10021Q0K
977	2210508617	E453N3N10021Q0L
978	2210508618	E453N3N10021Q0M
979	2210508619	E453N3N10K11000
980	2210508620	E453N3N10K21I71
981	2210508621	E453N3N10K21I72
982	2210508622	E453N3N10K21I73
983	2210508623	E453N3N10K21I74
984	2210508624	E453N3N10K21I75
985	2210508625	E453N3N10K21I7A
986	2210508626	E453N3N10K21I7B
987	2210508627	E453N3N10K21I7C
988	2210508628	E453N3N10K21I7D
989	2210508629	E453N3N10K21I7E
990	2210508630	E453N3N10K21I7G
991	2210508631	E453N3N10K21I7H
992	2210508632	E453N3N10K21I7K
993	2210508633	E453N3N10K21I7L
994	2210508634	E453N3N10K21I7M
995	2210508635	E453N3N10K21Q01
996	2210508636	E453N3N10K21Q02
997	2210508637	E453N3N10K21Q03
998	2210508638	E453N3N10K21Q04
999	2210508639	E453N3N10K21Q05
1000	2210508640	E453N3N10K21Q0A

THIS DRAWING CONTAINS INFORMATION THAT IS PROPRIETARY TO MOLEX ELECTRONIC TECHNOLOGIES, LLC AND SHOULD NOT BE USED WITHOUT WRITTEN PERMISSION		CURRENT REV DESC: OBSOLETE PART NUMBERS		  E453XXXXXXXXXX DIN FORM A EN 175301-803		
DIMENSION UNITS	SCALE					
mm	NTS			SD-121050-006		
GENERAL TOLERANCES (UNLESS SPECIFIED)				DOC TYPE DOC PART REVISION		
				PSD 001 D		
				SHEET NUMBER		
				8 OF 10		
		DRAFT WHERE APPLICABLE MUST REMAIN WITHIN DIMENSIONS		SERIES		
		THIRD ANGLE PROJECTION		121050		
		DRAWING		MATERIAL NUMBER		
		A3-SIZE		SEE SHEET 2 & 4		
				CUSTOMER		
				GENERAL MARKET		

