

PART NAME: KNOB

SCALE: 1:1

DATE: 8/13/13

DR. BY: JAM



DESIGNERS & MANUFACTURERS  
OF KNOBS, HANDLES, CAPS &  
CUSTOM PLASTIC COMPONENTS

P/N 1226-J

THIS DRAWING IS THE PROPERTY OF DAVIES MOLDING COMPANY, IS SUBMITTED SOLELY AS A DESIGN OR ENGINEERING PROJECT.  
WE ACCEPT NO RESPONSIBILITY WHATSOEVER FOR THE PRACTICAL APPLICATION OF THE PIECES MADE TO THIS DESIGN.

MOLD #	1226
CAVITY	1226
CORE	1226
PIN	1226-J

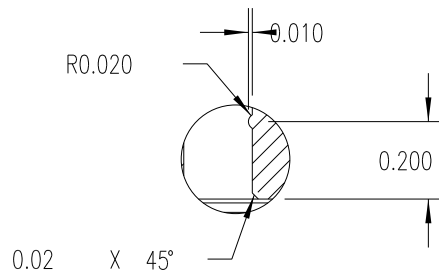
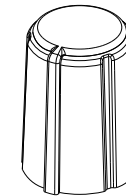
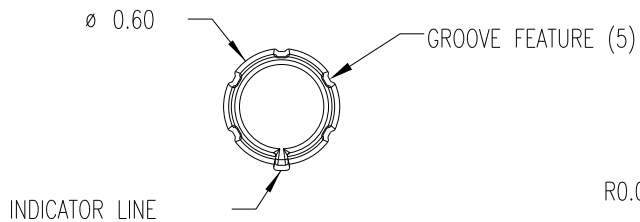

DETAIL A  
SCALE 2 : 1

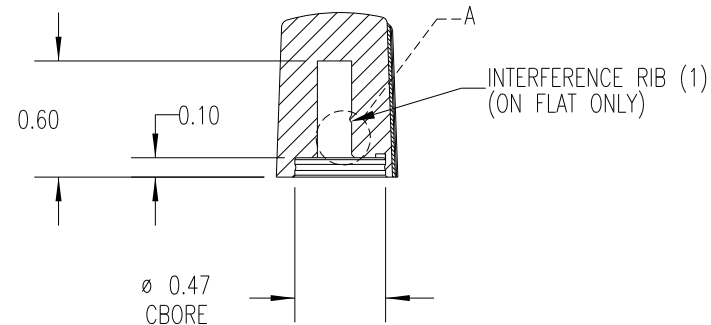
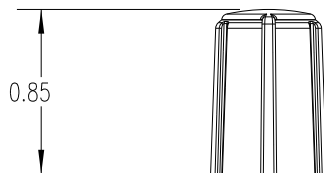

SECTION A-A

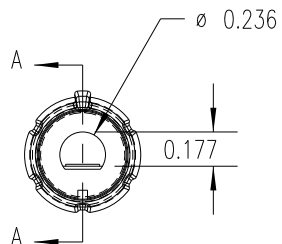

SUBSTRATE MATERIAL: POLYPROPYLENE (CLD)  
COLOR: WHITE (PC23083)

OVERMOLD MATERIAL: TPE (TPE3)  
COLOR: BLACK

TOLERANCES: UNLESS OTHERWISE SPECIFIED	DO NOT SCALE DRAWING			
DECIMALS: X.XXX ± .005 X.XX ± .015	MM: X.XX ± 0.15MM X.X ± 0.4MM			
FRACTIONS ± 1/64	ANG. ± 1°	CHANGES		