

TYPE C/2

Female connector – straight and angled – 16, 32 and 48 positions

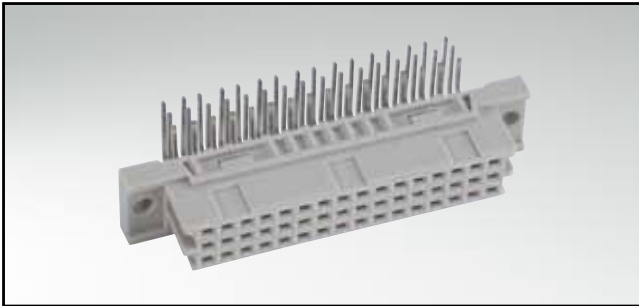

RoHS compliant

DESCRIPTION

- Solder pin, solder lug and wire wrap
- Quality class 3 (also available in quality class 2 or 1)
- Special assembly on request

PRODUCT DRAWING

PCB-hole pattern

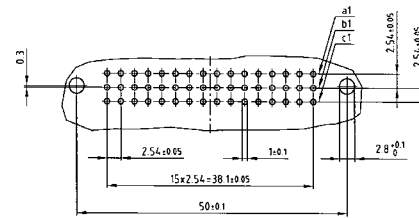

Panel cutout

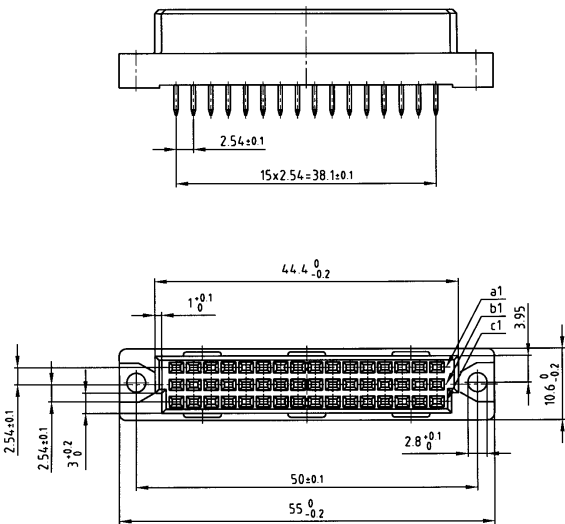
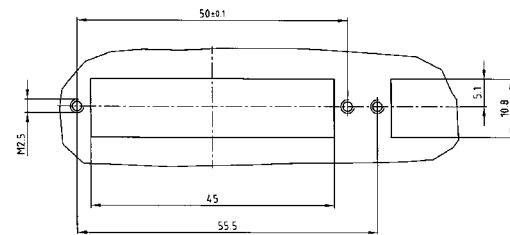

Wire Wrap

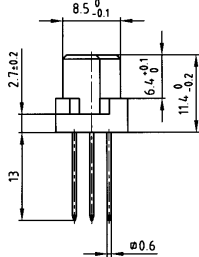

Solder pin straight 2.5 mm

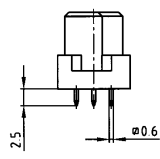

Solder pin straight 4 mm

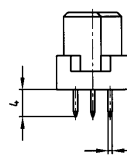

Solder lug

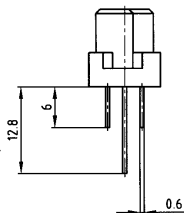

Solder pin angled

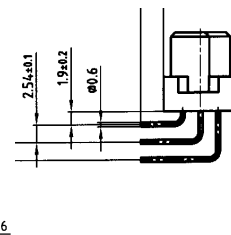

Solder pin straight 2.5 mm with clip

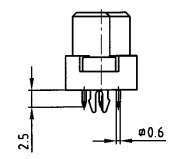

ORDER DATA

(Dim. = mm)

No. of Pos.	Row	• = contact, + = no contact					Wire Wrap	Solder pin straight 2.5 mm	Solder pin straight 4 mm	Solder lug	Solder pin angled	Solder pin straight 2,5 mm with clip
		Pos.	1	2	3	4						
16	a		•	•	•	•						
	b	+	+	+	+	+	122 A 10579 X	122 A 10629 X	122 A 10679 X	122 A 10729 X	122 A 10779 X	122 A 13299 X
	c	+	+	+	+	+						
16	a		•	•	•	•						
	b	+	+	+	+	+	122 A 10589 X	122 A 10639 X	122 A 10689 X	122 A 10739 X	122 A 10789 X	122 A 13309 X
	c	+	•	•	•	•						
32	a		•	•	•	•						
	b	+	+	+	+	+	122 A 10609 X	122 A 10659 X	122 A 10709 X	122 A 10759 X	122 A 10809 X	122 A 13329 X
	c		•	•	•	•						
48	a		•	•	•	•						
	b		•	•	•	•	122 A 10619 X	122 A 10669 X	122 A 10719 X	122 A 10769 X	122 A 10819 X	122 A 13339 X
	c		•	•	•	•						

Clip for hole diameter 2.8 + 0.1 mm, PCB thickness = 1.6 mm