

SBE® 80 / SBO® 60 Connectors

Up to 80 Amps



SBE® and SBO® connectors build on the capability of the two pole SB® connectors by offering up to 8 auxiliary power / signal contacts along with an IEC 60950 touch safe housing. The center of the main connector features a connector holder for either: two PP15/45, two PPMX, or APP's innovative 1x4 auxiliary connector.

- **Touch Safe Interface**

Minimizes potential contact with live circuits per IEC 60950

- **Up to 8 Last Mate / First Break Auxiliaries**

Enables intelligent power switching, CAN and interlock loop circuitry, as well as power up to 20 amps per pole

- **Silver Plated Wire Contacts up to 4 (25 mm²)**

Allows UL rated currents up to 80 amps per pole

SBE® 80 / SBO® 60

SBE® 80 / SBO® 60 ORDERING INFORMATION

SBE® 80 / SBO® 60 Housings

The smallest size of SBE®, X, O style housing. SBE® 80 and SBO® 60 housings of the same Voltage Color-Code can be mated but is not recommended as it invalidates UL approvals for SBO® 60. SBO® 60 housings do not meet EN1175-1 requirements for industrial trucks.

Description	SBE® 80 Part Numbers		SBO® 60 Part Numbers	
	Minimum Quantity	Color	Minimum Quantity	Color
Yellow	400	SBE80YEL-BK SBE80YEL	400	SBO60YEL-BK SBO60YEL
Orange		SBE80ORN-BK SBE80ORN		SBO60ORN-BK SBO60ORN
Red		SBE80RED-BK SBE80RED		SBO60RED-BK SBO60RED
Gray		SBE80GRA-BK SBE80GRA	N/A	N/A
White		N/A N/A	SBO60WHT-BK SBO60WHT	

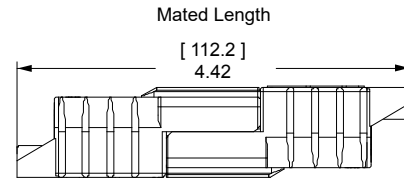

Side View

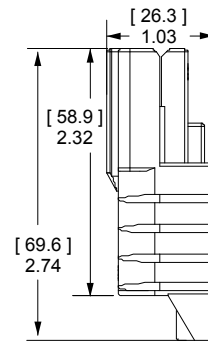

Top View

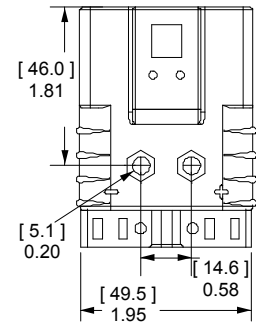

SBE® 80 / SBO® 60 Silver Plated Primary Power Wire Contacts

Use two silver plated contacts per housing for the best electrical performance and durability up to 10,000 mating cycles. See reducing bushings in accessory section for smaller wire size.

AWG	mm ²	Mating Force	Loose Piece Part Numbers		Dimensions			
			- A -	- B -	inches	mm	inches	mm
Minimum Quantity			1,000	100				
4	25	Low	1339G4-BK	1339G4 *	0.28	7.11	0.35	9.0
6	16	High	1339G1-BK	1339G1 *	0.22	5.59	0.29	7.3

* Sold as pairs. 2 parts shipped for every 1 part ordered.

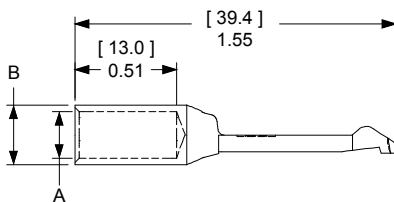

SBE® 80 / SBO® 60 CONNECTOR TEMPERATURE CHARTS - Temperature rise charts are based on a 25°C ambient temperature.

Current - Temperature Derating per IEC 60512-5-2 Test 5B

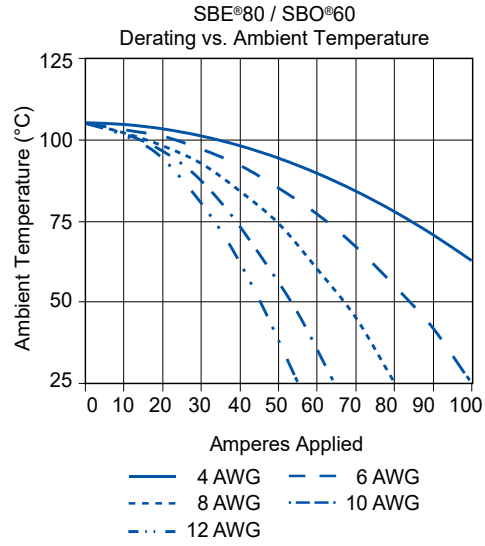
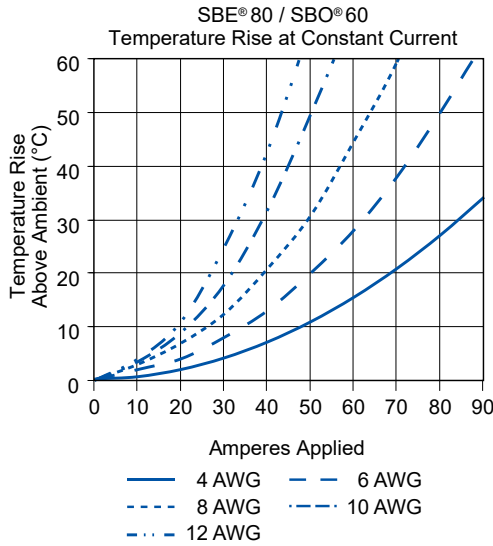

SBE® 80 / SBO® 60 CONNECTOR SPECIFICATIONS

ELECTRICAL

Current Rating Amperes ¹	SBO® 60	SBE® 80
Primary Power (6 AWG)	70	80
Powerpole® Auxiliary (12 AWG)	20	20
1x4 Auxiliary (12 AWG)	20	20
PPMX Auxiliary (20 AWG)	7 UL	5 CSA
Voltage Rating AC/DC	UL 1977	EN1175-1
Primary Power	600	150 ⁴
Powerpole® Auxiliary	600	150 ⁴
1x4 Auxiliary	200	
PPMX Auxiliary	300	
Dielectric Withstanding Voltage Primary Power		
Volts AC	2,200	
Avg. Mated Contact Resistance Milliohms ¹		
1 1/4" of 6 AWG wire	0.200	
Hot Plug Current Rating Amperes - 250 Cycles at 120V DC		
Power	60A	
Powerpole® Auxiliary	30A	
1x4 Auxiliary	5A	

Specifications continued on next page

MATERIALS**Housing**

SBE® / SBO® & 1x4 Auxiliary Housing	Polycarbonate / PBT blend
Powerpole® Plastic Resin	Polycarbonate
Contact Retention Spring	Stainless Steel

Housing Flammability Rating

UL94	V-0
Glow Wire - SBE® 80 Only	960°C (GWFI) / 800°C (GWIT)

Power & Powerpole® Contact

Silver Plated Copper Alloy

1x4 Auxiliary Contacts

Pin	Copper alloy, Au over Ni
Socket	BeCu, Au over Ni
Socket Body	Copper Alloy, Sn Bright Over Ni
Retention Clip	Stainless Steel

PPMX Contacts

Gold Plated Copper Alloy

Contact Termination Methods

Crimp ³
Hand Solder



NOTE 1: See IEC 60664-1 for working voltage.

NOTE 2: Amp ratings are stated per position and based on all positions being fully loaded.

1 - Based on: 105°C rated or better cable of the largest size. Properly calibrated APP® recommended tooling, and a 25°C ambient temperature. UL rating not to exceed the maximum operating temperature. CSA rating below a 30°C temperature rise. Only SBO® 60 has UL recognition.

2 - Limited by the thermal properties of the connector plastic housing.

3 - Use APP® recommended tooling only. Alternate tools may adversely affect the performance of our connectors along with UL and CSA recognition.

4 - Voltage capability of SBE® housings is identical to SBO®, but derated to meet EN1175-1 requirements.

MECHANICAL

Wire Size Range	AWG	mm ²
Power Contacts	6 to 4	16 to 25
Auxiliary Contacts	24 to 10	0.25 to 5.3

Max. Wire Insulation Diameter

	in.	mm
Power Contacts	0.440	11.200
Powerpole® Auxiliary	0.175	4.450
1x4 Auxiliary	0.140	3.600

Operating Temperature ²

	°F	°C
SBO® and SBE® Housings	-4° to 221°	-20° to 105°

Mating Cycles No Load by Plating

	Silver (Ag)	Gold (Au)
Power Contacts	10,000	
Powerpole® Auxiliary	10,000	
1x4 Auxiliary		10,000
PPMX Auxiliary		5,000

Avg. Mating / Unmating Force

	Lbf.	N
Main Connector Housing	16	70
Per Powerpole® Connector	5	22
Per Contact in 1x4 Auxiliary	0.7	3.0
Per PPMX Housing	4.50	20.00

Min. Contact / Spring Retention Force

	Lbf.	N
Power Standard Housing	50	222
Powerpole® Housing	25	111
1x4 Auxiliary Housing	10	44.5
PPMX Housing	12	53

IEC INFORMATION

Connector Series	Configurations	Creepage / Clearance per IEC 60950-1	Material Group
SBE® 80	Unmated	4.23 mm	IIla
	Mated	7.9 mm	

PROTECTION**Touch Safety Main Connector Housing**

IEC 60950	Pass
IEC 60529	IP20



SBE® 80 / SBO® 60 ACCESSORIES

Cable Clamps

Clamps are made out the same chemical resistant PBT material that is used in the SBE® housings. Clamp holds the cable between the clamp piece and the connector housing. Screws must be ordered separately for part numbers starting with "113".

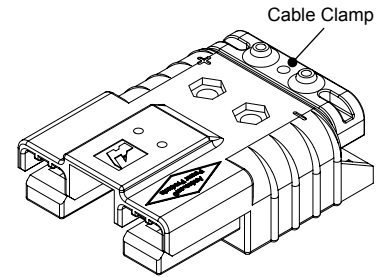

Description	Part Numbers		
Minimum Quantity	100		25
Red Clamp and Hardware Kit	-		SBE80CLPRED or SBO60CLPRED
Red Clamp Only	113953P1		-
Screws (2 per clamp)	H1120P42	(Individual)	-

"T" Handle *

Handles are made out the same chemical resistant PBT material that is used in the SBE® housings. (2) screws and (2) nuts are required to attach each handle.

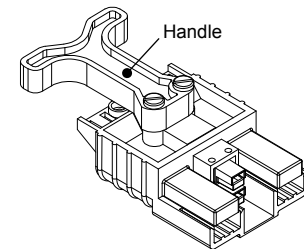

Description	Part Numbers		
Minimum Quantity	500	100	25
Red Handle and Hardware Kit	-		SBE80HDLRED or SBO60HDLRED
Red Handle Only	113952P1		-
Hardware Bag	-		105G13
M5 x 35mm Screws	-	113715P4	-
M5 Nut	-	113716P3	-

* Torque value 12 (in - lbs) / 1.4 (Nm)

NOTE: For assembly of clamp to housing only

Powerpole® Auxiliary

Powerpole® auxiliary connectors are rated up to 30 amps 600 volts and can be used for auxiliary power, control or sensing. The auxiliary kit includes (1) each black and red Standard Powerpole® housing, (2) contacts, (2) zip cable straps, and (2) retaining pins.

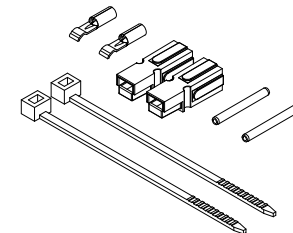

Description	Part Numbers	
Minimum Quantity	200	25
Powerpole® Auxiliary Kit	-	6344
Black Powerpole® Housing	1327G6	-
Red Powerpole® Housing	1327	-
16 to 12 Contact	1331	-
Retaining Pin	-	-

NOTE: Finger proof PP15/45 housings should not be used for auxiliary contacts.

1x4 Auxiliary Connector

The unique 1x4 auxiliary connector allows up to 4 auxiliary circuits up to 20 amps 200 volts each in SBE®, SBO®, & SBX® housings. The genderless design holds two each of the gold plated pin & socket contacts. This innovation allows the very durable and cost effective design of SBE®, O, X connectors to substitute for DIN 43589-1 applications where 4 auxiliary contacts are required. Multiple pin lengths allow the further benefit of sequencing between circuits. (2) Retaining pins are required to hold the auxiliary housing in place. Auxiliary Kits include (1) Auxiliary Housing, (2) Standard Length Pin Contacts, and (2) Socket Contacts, (2) Retaining Pins and (1) Retaining Clip.

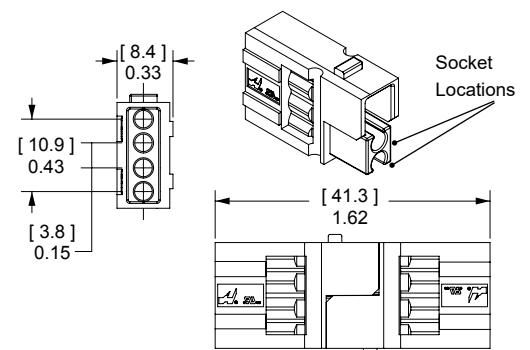

Description	AWG	mm²	Part Numbers		
Minimum Quantity			1,000	250	25
1x4 Auxiliary Kit	12	4	-	-	441G3
1x4 Auxiliary Kit	16 to 14	1.5 to 2.5	-	-	441G1
1x4 Auxiliary Kit	20 to 16	0.75 to 1.5	-	-	441G2
1x4 Auxiliary Housing	Contacts Sold Separately		3-5956P1	444G1	-

Pin Contacts for 1x4 Auxiliary Connector

Gold plated contacts are available in 4 lengths to allow sequencing of circuits.

Description	AWG	mm ²	Part Numbers	
Minimum Quantity			500	50
Standard Length 7.7 mm	12	2.5	PM16P12S30	PM16P12S30-50
	16 to 14	1.0 to 1.5	PM16P1416S30	PM16P1416S30-50
	20 to 16	0.75 to 1.0	PM16P1620S30	PM16P1620S30-50
	24 to 20	0.50 to 0.75	PM16P2024S30	PM16P2024S30-50
Pre-Mate 9.3 mm	12	2.5	PM16P12A30	-
	16 to 14	1.0 to 1.5	PM16P1416A30	-
	20 to 16	0.75 to 1.0	PM16P1620A30	-
	24 to 20	0.50 to 0.75	PM16P2024A30	-
Post-Mate 6.4 mm	12	2.5	PM16P12C30	-
	16 to 14	1.0 to 1.5	PM16P1416C30	-
	20 to 16	0.75 to 1.0	PM16P1620C30	-
	24 to 20	0.50 to 0.75	PM16P2024C30	-

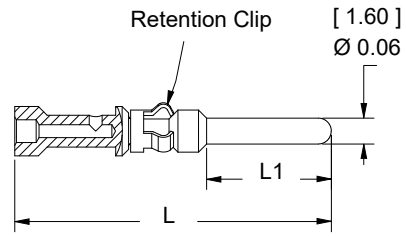

Auxiliary Pin Contact Lengths	- L -		- L1 -	
	in.	mm	in.	mm
Standard Length 7.7 mm	0.77	19.6	0.30	7.7
Pre-Mate 9.3 mm	0.83	21.2	0.37	9.3
Post-Mate 6.4 mm	0.72	18.3	0.25	6.4

Socket Contacts for 1x4 Auxiliary Connector

Selectively gold plated contacts offer low resistance and durability up to 10,000 mating cycles.

Description	AWG	mm ²	Part Numbers	
Minimum Quantity			500	50
Socket Contact	12	2.5	PM16S12S32	PM16S12S32-50
	16 to 14	1.0 to 1.5	PM16S1416S32	PM16S1416S32-50
	20 to 16	0.75 to 1.0	PM16S1620S32	PM16S1620S32-50
	24 to 20	0.50 to 0.75	PM16S2024S32	PM16S2024S32-50

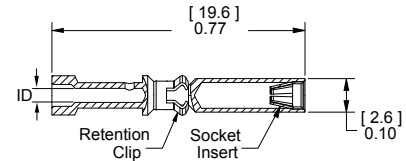

Auxiliary Socket Contacts Crimp Barrel ID		
Wire Gauge	in.	mm.
24 to 20	0.04	1.1
20 to 16	0.07	1.7
16 to 14	0.08	2.1
12	0.10	2.6

PPMX Auxiliary Connector

The PPMX auxiliary connector allows up to 8 auxiliary circuits to be used in the SBE®, SBO®, & SBX® housings. There are 4 auxiliary circuits per PPMX connector and two PPMX housings fit into the auxiliary port in the main connector housing. Rated up to 7 amps 300 volts per contact, the genderless design holds two each gold plated pin & socket contacts. This innovation allows the very durable and cost effective equipment design of SBE®, O, X connectors to be used for applications requiring up to 8 battery monitoring or vehicle communication circuits. (2) Retaining pins or (1) Retaining clip is required to hold the auxiliary housing in place.

Auxiliary Kits include (1) Auxiliary Housing, (2) Pin Contacts, and (2) Socket Contacts.

Description	AWG	mm ²	Part Numbers		
Minimum Quantity			1,000	100	25
PPMX Auxiliary Kit	24 to 20	0.50 to 0.25	-	4850G6	-
1x4 Auxiliary Housing	Contacts Sold Separately		4827G6-BK	-	4827G6

* No extraction tool required for contact removal.

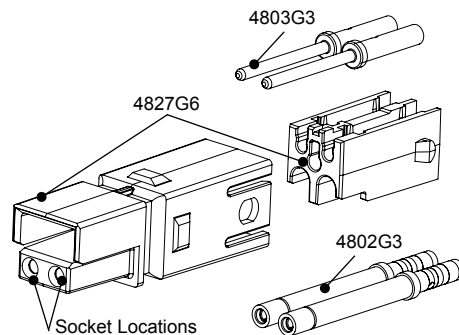

Pin & Socket Contacts for PPMX Auxiliary Connector

Gold plated contacts are ideal for signal or low power use with durability up to 5,000 mating cycles.

Description	AWG	mm ²	Part Numbers	
Minimum Quantity			2,000	50
Pin Contacts	24 to 20	0.50 to 0.25	4803G3-BK	4803G3
Socket Contacts	24 to 20	0.50 to 0.25	4802G3-BK	4802G3

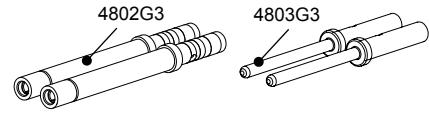

NOTE: Contacts sold individually, not sold as a set of two.

SBE® Air Tubes

Air tubes fit into SBE® housings to allow electrolyte circulation while charging the battery. Genderless tube design allows the same part to be used on both sides. (2) Retaining pins are required to hold the air tube in place. Retaining pins are included in Air Tube Kit.

Description	Part Numbers	
Minimum Quantity	500	25
Air Tube Kit, Black	-	6396G1
Air Tube Only	3-5798P1	-

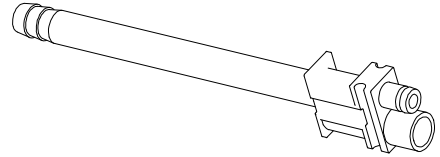

Retaining Pins

Retaining pins are used to hold accessories in the auxiliary port in SBE®, SBO®, & SBX® housings. Dimension "B" is +/- 0.015 in or 0.38 mm.

Description	Part Numbers		Dimensions			
			- A -		- B -	
			inches	mm	inches	mm
Minimum Quantity	1,000	100				
For SBE® 80 & SBO® 60	110G9-BK	110G9	0.093 / 0.099	2.36 / 2.51	0.85	21.59

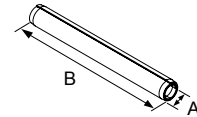

Zip Cable Straps

Zip cable straps are used to secure auxiliary wires to the side of the main power cables.

Description	Part Number
Minimum Quantity	1,000
White	H1835P3

Use cable ties to secure auxiliary contact leads to one of the main cables.

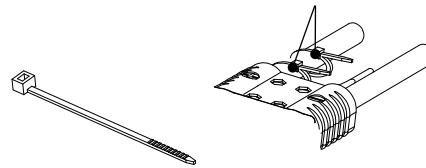

Reducing Bushings

Use with contact part number 1339G1 to allow a smaller wire to be used with the connector. Electrical capability is derated with smaller wire.

Contact Barrel Size		Wire Size		Part Numbers			Dimensions			
AWG	mm ²	AWG	mm ²				- ID -		- Length -	
							inches	mm	Inches	mm
Minimum Quantity				3,000	1,000	100				
6	13.3	8	8.4 mm ²	-	5912-BK	5912	0.18	4.57	0.45	11.43
6	13.3	12 to 10	3.3 to 5.3	5910-BK	-	5910	0.14	3.56	0.47	11.94
6	13.3	16 to 14	1.3 to 2.1	5913-BK	-	5913	0.09	2.29	0.47	11.94

