

SYMBOL DEFINITION		
A DIMENSION WITHOUT AN INSPECTION REPORT SYMBOL  DOES NOT REQUIRE INSPECTION. IT MAY BE CONTROLLED ON THE INDIVIDUAL COMPONENT DRAWING.	TOTAL NO. OF INSPECTIONS REQUIRED	3
	LAST NO. USED	3

MISSING SYMBOLS
NO MISSING SYMBOL NUMBER

DWG STATUS					ZONE	REVISION HISTORY			AUTH	DR	APVD 1	APVD 2
DATE	STG	REV	N/P	CHG								
25MY05	R	01	-	-		WAS PE131457 AND RELEASED			267379	AKJ	AKJ	GER
22SE05	R	01	AA	-		UPDATED PDM ATTRIBUTES			272710	JS	JS	GER

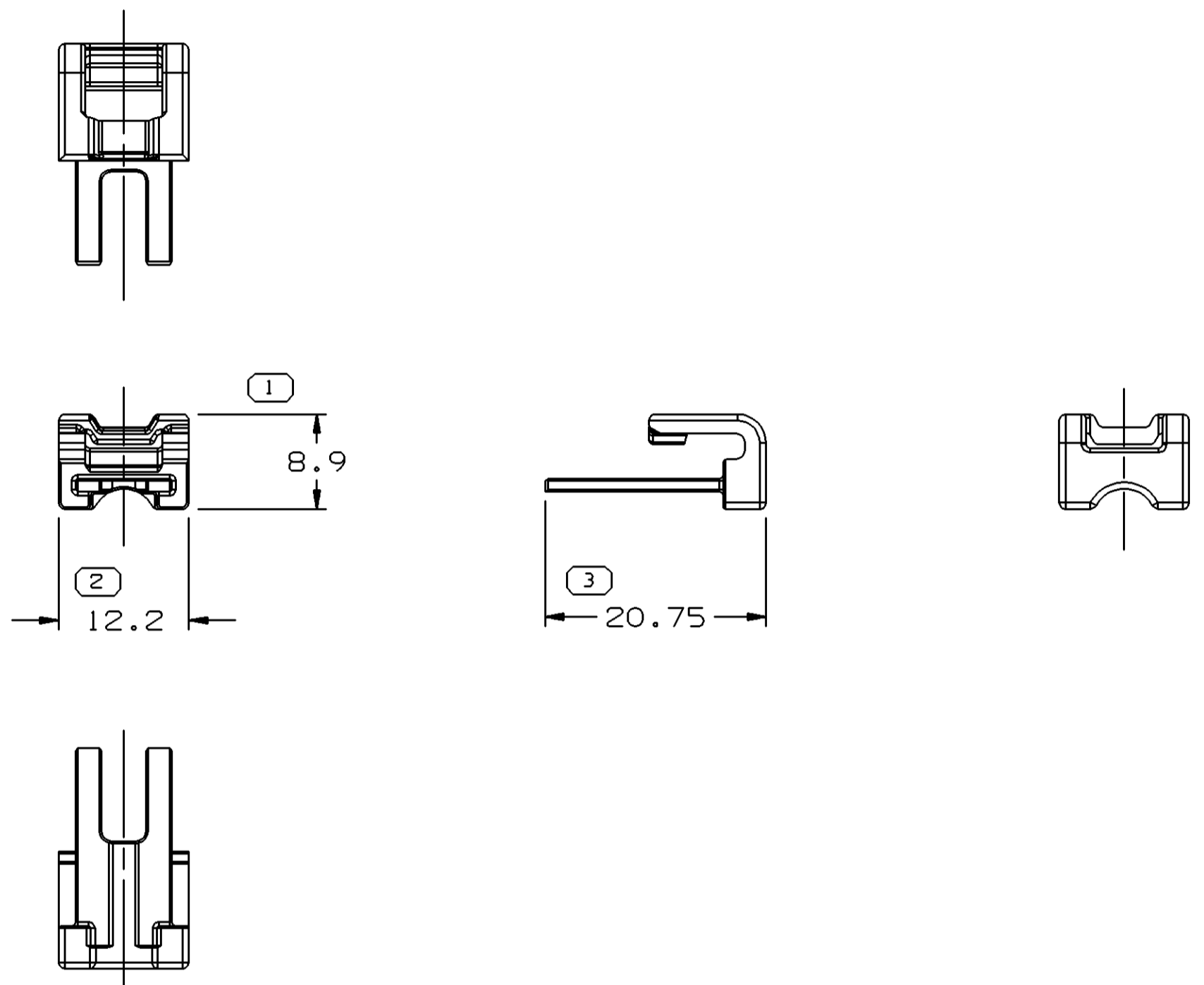

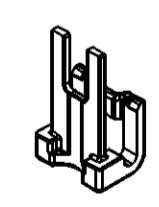

- NOTES
- UNLESS OTHERWISE SPECIFIED AND/OR INDICATED:
DIMENSIONS ARE TO FACE OF VIEW SHOWN AND AUTOMATICALLY ROUNDED BY COMPUTER FOR INSPECTION (SEE MATH MODEL FOR PRECISE DIMENSIONS). FOR ALL OTHER DIMENSIONS NOT SHOWN BUT REQUIRED FOR TOOL BUILD, SEE MATH MODEL FOR PRECISE TOOL PATH DATA.
 - REFERENCE MATING COMPONENTS OR EQUIVALENT:
POWER DISTRIBUTION BOX 13512993



 N/A PROCESS SENSITIVE DIMENSION
DIMENSIONS ENCLOSED IN () INDICATE REFERENCE DIMENSIONS AND NO TOLERANCE LIMITS ARE ESTABLISHED

DIMENSIONAL RANGE (MM)										CHART	EI
FROM	> 0	> 20	> 30	> 70	> 100	> 150	> 200	> 250	> 300		
TO	20	30	70	100	150	200	250	300	400		
TOLERANCE UNLESS OTHERWISE SPECIFIED											
	±0.15	±0.2	±0.3	±0.4	±0.5	±0.6	±0.8	±1	±1.2		
ANGULAR TOLERANCE ±2°											

DWG TYPE PART DRAWING	
STYLE	
VOLUME (CM ³) 0.475	DISTR CODE D
UNLESS OTHERWISE SPECIFIED THIS DOCUMENT IS IN ACCORDANCE WITH ASME Y14.5M-1994 AS AMENDED BY THE GM GLOBAL DIMENSIONING AND TOLERANCING ADDENDUM-2001. SEPARATE PATTERNS OF FEATURES MAY BE GAGED SEPARATELY REGARDLESS OF DATUM REFERENCES.	
ALL DIMENSIONS ARE IN MILLIMETERS	
REFERENCE	
THIRD ANGLE PROJECTION	DO NOT SCALE USE MATH DATA
	
	

DELPHI
DELPHI PACKARD ELECTRIC SYSTEMS
WARREN, OH

DATE	
DR J. GARRETSON	12N004
APVD1 ANAND JAGANATHAN	25MY05
APVD2 ANAND JAGANATHAN	25MY05
APVD3 G. ROBISON	25MY05
APVD4	
APVD5	
SUBSTANCES OF CONCERN AND RECYCLED CONTENT PER DELPHI 10949001	
MATERIAL M3592008 PA66 HS IM BLU	
DRAWING NAME LOCK TPA GT 630 BLU	
DRAWING NUMBER 13518492	
SIZE A2	SCALE 2:1
FRAME NO 1 OF 1	SHEET NO 1 OF 1
STG R	REV 01
N/P AA	