

## General Description

Delta SMA connectors are subminiature, precision, 50 Ω impedance connectors with 1/4"-36 threaded coupling. They are best suited for use with high-frequency semi-rigid cables in demanding applications up to 18 GHz, or miniature flexible cables up to 12.4 GHz. Our extensive line of SMA receptacles includes configurations for virtually any packaging requirement, and we can supply any adapter or accessory you may need to complete your system design. Adapters between SMA and other series are shown starting on page 176. Many of our SMA connectors are available as MIL-PRF-39012 QPL versions. These types are listed starting on page 195.

As with our other connector series, Delta's customer-driven design results in SMA series connectors with practical and unique features that make your design and assembly process easier. Some of these include:

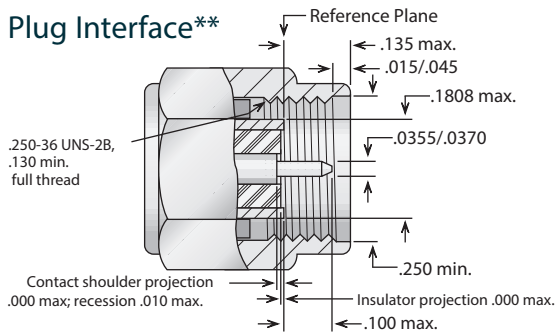
- One-Step cable connectors for quick, accurate assembly to semi-rigid cable.
  - PressMount receptacles (page 115) mount securely in a single round hole, saving space on your components and reducing your housing fabrication costs.
  - Panel receptacles with flange sizes to match the same hole pattern as standard BNC, TNC or N connectors, letting you drill one hole pattern and mount BNC, N, SMA, TNC, or 7/16 series connectors as needed.
  - Edge-mount P.C. board receptacles (page 114).
  - Our new E-Line brass SMA connectors provide a lower-cost alternative for commercial applications (page 123).
- Our SMA series product line is still growing, so please call if you don't see what you need.

## SMA Configuration

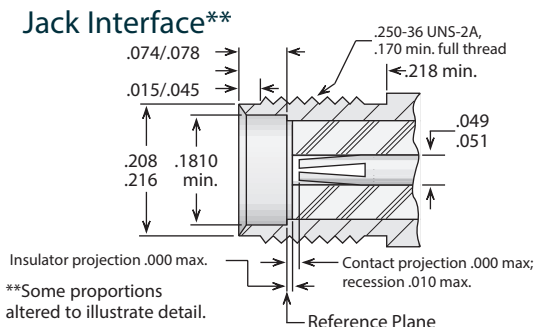
Cable Plugs for Semi-Rigid Cable .....	2	Right Angle Panel Jack Receptacles .....	11
Cable Plugs for Flexible Cable .....	3	Stripline Receptacles .....	11
Straight Cable Jacks for Semi-Rigid Cable .....	4	Bulkhead Jack Receptacles .....	12
Bulkhead Cable Jacks for Semi-Rigid Cable .....	4	P.C. Board Receptacles (Through-Hole Mount) .....	12
Panel Cable Jacks for Semi-Rigid Cable .....	4	P.C. Board Receptacles (Edge Mount) .....	13
Straight Cable Jacks for Flexible Cable .....	5	PressMount Receptacles .....	14
Bulkhead Cable Jacks for Flexible Cable .....	5	Panel Plug Receptacles .....	15
Straight Panel Jack Receptacles .....	6	Dust Caps .....	19
Panel Jack Receptacles for Microstrip .....	10	In-Series Adapters .....	20

## SMA Specifications\*

### Plug Interface\*\*



### Jack Interface\*\*



### Electrical:

Nominal Impedance: 50 ohms.  
 Frequency Range: DC–18 GHz (with semi-rigid cable);  
 DC–12.4 GHz (with flexible cable).  
 Voltage Rating: 335–500 volts RMS (dependent on cable).  
 Dielectric Withstanding Voltage : 500–1500 volts RMS (dependent on cable).  
 Insulation Resistance: 5,000 megohms.

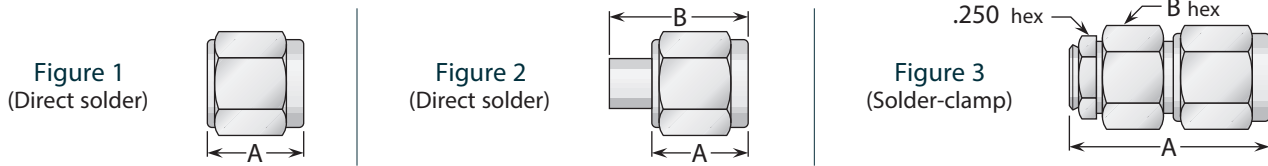
### Materials/Finishes:

Insulators: Teflon per ASTM D1710.  
 Male Contacts: Brass per ASTM B16, or Beryllium Copper per ASTM B196.  
 Female Contacts: Beryllium Copper per ASTM B196.  
 Contact Plating : Gold per MIL-DTL-45204.  
 Gaskets: Silicone rubber per ZZ-R-765, Class II, Grade 50.  
 Other Metal Parts: Stainless steel per ASTM A582, plated gold per MIL-DTL-45204 or passivated to meet corrosion requirements of MIL-PRF-39012; or Brass per ASTM B16: plated gold per MIL-DTL-45204.

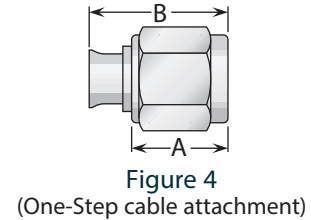
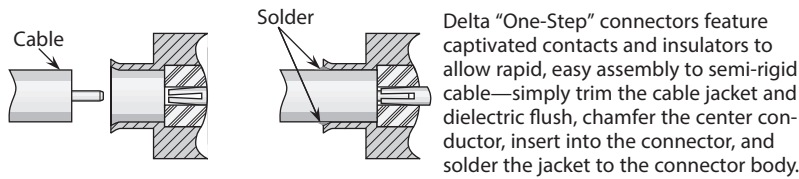
All other specifications are in accordance with the latest issues of MIL-PRF-39012, or MIL-A-55339, or other applicable MIL specifications, and interfaces are in accordance with MIL-STD-348.

\*These specifications are typical and may not apply to all connectors. Detailed specifications for individual connectors are available on request.

## Straight Plug - For Semi-Rigid Cable



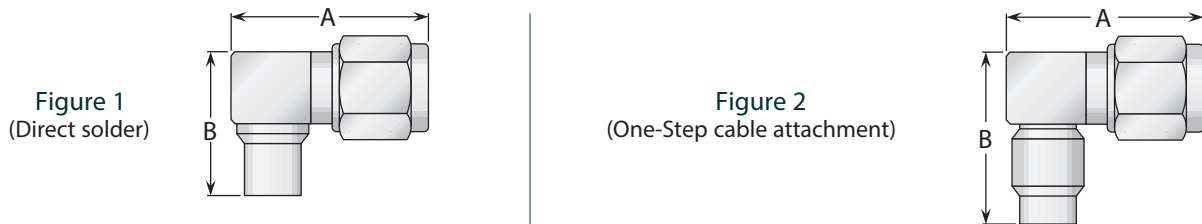
### Delta One-Step Cable Attachment for Semi-Rigid Cable



Cable Group	Figure	Dimensions		Plating		Delta P/N	Assembly Procedure/Trim Code
		A	B	Body	Contact		
13	1	.330	—	Gold	None <sup>(2)</sup>	1301031G003-000	G/01
13	1	.330	—	Gold/PCN <sup>(1)</sup>	None <sup>(2)</sup>	1301031K003-000	G/01
13	2	.330	.445	Gold	None <sup>(2)</sup>	1301031G003-002	G/01
13	2	.330	.445	Gold/PCN <sup>(1)</sup>	None <sup>(2)</sup>	1301031K003-002	G/01
13	2	.330	.445	Gold	Gold	1301031G003-003	H/01
13	2	.330	.445	Gold/PCN <sup>(1)</sup>	Gold	1301031K003-012	H/01
13	3	.680	.312	Gold	Gold (C)	1301031G007-000	***
13	4	.330	.430	Gold/PCN <sup>(1)</sup>	Gold (C)	1301031K003-008	I/01
14	2	.330	.445	Gold	Gold	1301094G003-000	H/01
14	2	.330	.445	Gold/PCN <sup>(1)</sup>	Gold	1301094K003-000	H/01
14	3	.680	.312	Gold	Gold (C)	1301025G007-000	***
14	4	.330	.430	Gold/PCN <sup>(1)</sup>	Gold (C)	1301094K003-001	I/01

<sup>(1)</sup> Gold-plated body and passivated coupling nut. <sup>(2)</sup> Cable center conductor used as contact.

## Right Angle Plug - For Semi-Rigid Cable



Cable Group	Figure	Dimensions		Plating		Delta P/N	Assembly Procedure/Trim Code
		A	B	Body	Contact		
13	1	.680	.430	Gold	Gold (C)	1305031G003-000	J/01
13	1	.680	.430	Gold/PCN <sup>(1)</sup>	Gold (C)	1305031K003-000	J/01
13	2	.570	.580	Gold	Gold (C)	1305031G003-002	I/01
13	2	.570	.580	Gold/PCN <sup>(1)</sup>	Gold (C)	1305031K003-004	I/01
14	1	.680	.430	Gold	Gold (C)	1305025G003-000	J/01
14	1	.680	.430	Gold/PCN <sup>(1)</sup>	Gold (C)	1305025K003-000	J/01
14	2	.570	.580	Gold	Gold (C)	1305094G003-003	I/01
14	2	.570	.580	Gold/PCN <sup>(1)</sup>	Gold (C)	1305094K003-005	I/01

<sup>(1)</sup> Gold-plated body and passivated coupling nut.

- See page 209 for cable groups.
- Assembly procedures start on page 210.
- \*\*\*Contact factory for cable assembly instructions.
- (C) in contact plating column indicates captive contact.

## Straight Plug - For Flexible Cable

Figure 1  
(Crimp type, shown with  
supplied heat-shrink tubing)

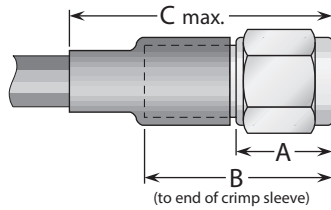
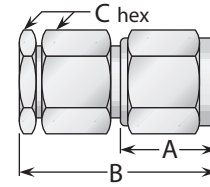


Figure 2  
(Clamp type)

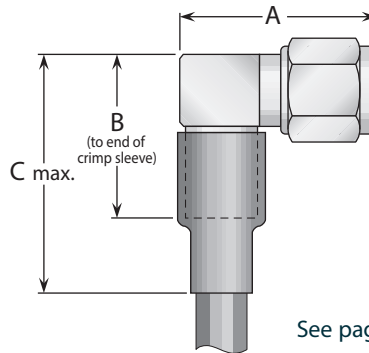


See page 194 for MIL-PRF-39012 QPL version.

Cable Group	Figure	Dimensions			Plating		Delta P/N	Assembly Procedure/ Trim Code
		A	B	C	Body	Contact		
5	1	.330	.700	1.187	Gold	Gold	1303017G000-000	K/02
5	1	.330	.700	1.187	Passivated	Gold	1303017K000-000	K/02
6	1	.330	.700	1.187	Gold	Gold	1303013G000-000	K/02
6	1	.330	.700	1.187	Passivated	Gold	1303013K000-002	K/02
9	1	.330	.700	1.187	Gold	Gold	1303036G000-000	K/02
9	1	.330	.700	1.187	Passivated	Gold	1303036K000-000	K/02
10	1	.330	.700	1.187	Gold	Gold	1303100G000-002	K/02
10	1	.330	.700	1.187	Passivated	Gold	1303100K000-002	K/02
5, 6	2	.330	.750	.312	Gold	Gold (C)	1301015G005-000	***
5, 6	2	.330	.750	.312	Passivated	Gold (C)	1301015K005-000	***
9	2	.330	.750	.312	Gold	Gold (C)	1301037G005-000	***
9	2	.330	.750	.312	Passivated	Gold (C)	1301037K005-000	***

## Right Angle Plug - For Flexible Cable

Figure 1  
(Crimp type, shown with  
supplied heat-shrink tubing)

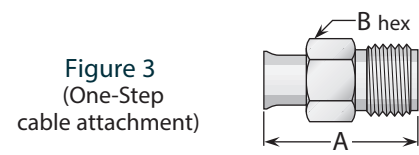
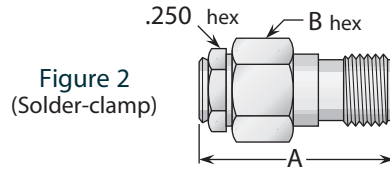
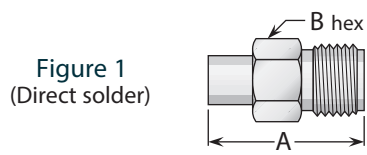


See page 195 for MIL-PRF-39012 QPL version.

Cable Group	Figure	Dimensions			Plating		Delta P/N	Assembly Procedure/ Trim Code
		A	B	C	Body	Contact		
5	1	.680	.600	1.06	Gold	Gold (C)	1307017G001-000	L/03
5	1	.680	.600	1.06	Passivated	Gold (C)	1307017K001-000	L/03
6	1	.680	.600	1.06	Gold	Gold (C)	1307013G001-000	L/03
6	1	.680	.600	1.06	Passivated	Gold (C)	1307013K001-000	L/03
9	1	.680	.600	1.06	Gold	Gold (C)	1307036G001-000	L/03
9	1	.680	.600	1.06	Passivated	Gold (C)	1307036K001-000	L/03
10	1	.680	.600	1.06	Gold	Gold (C)	1307100G001-000	L/03
10	1	.680	.600	1.06	Passivated	Gold (C)	1307100K001-000	L/03
11	1	.680	.600	1.06	Gold	Gold (C)	1307038G001-000	L/03
11	1	.680	.600	1.06	Passivated	Gold (C)	1307038K001-000	L/03

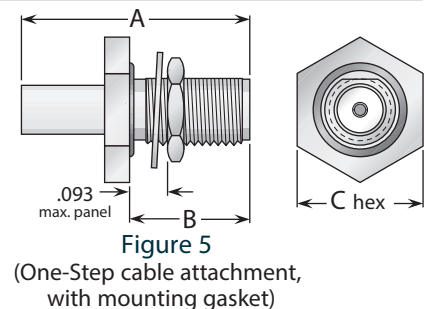
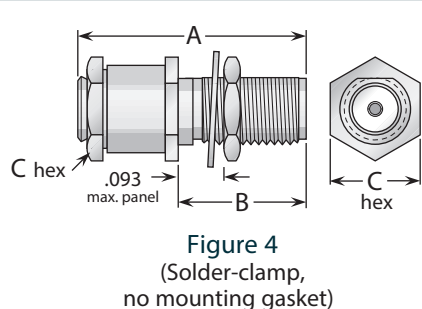
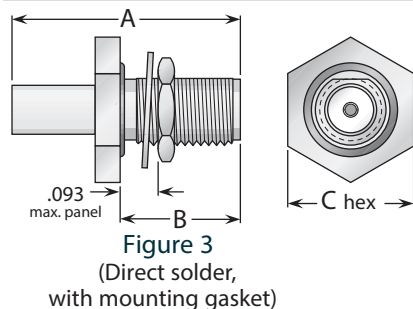
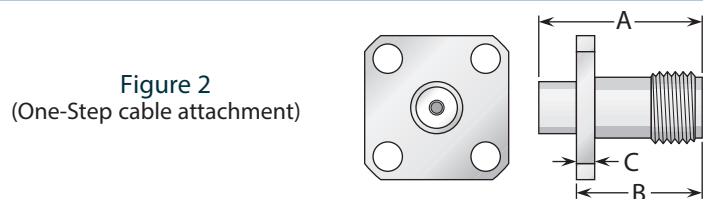
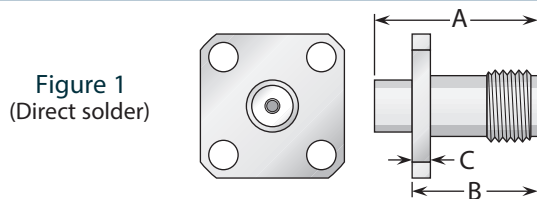
- See page 209 for cable groups.
- Assembly procedures start on page 210.
- \*\*\*Contact factory for cable assembly instructions.
- (C) in contact plating column indicates captive contact.

## Straight Jack - For Semi-Rigid Cable

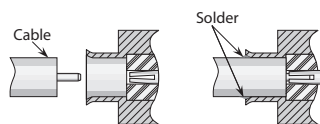


Cable Group	Figure	Dimensions			Plating		Delta P/N	Assembly Procedure/ Trim Code
		A	B	Body	Contact			
13	1	.500	.250	Gold	Gold	1308031G003-002	H/01	
13	2	.680	.312	Gold	Gold (C)	1308031G007-000	***	
13	3	.500	.250	Gold	Gold (C)	1308031G003-004	I/01	
14	1	.500	.250	Gold	Gold	1308094G003-000	H/01	
14	2	.680	.312	Gold	Gold (C)	1308025G007-000	***	
14	3	.500	.250	Gold	Gold (C)	1308094G003-001	I/01	

## Panel Bulkhead Jacks - For Semi-Rigid Cable



### Delta One-Step Cable Attachment for Semi-Rigid Cable

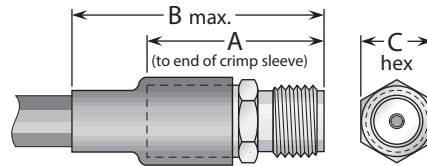


Delta "One-Step" connectors feature captivated contacts and insulators to allow rapid, easy assembly to semi-rigid cable—simply trim the cable jacket and dielectric flush, chamfer the center conductor, insert into the connector, and solder the jacket to the connector body.

Cable Group	Fig.	Dimensions			Mounting Figure	Plating		Delta P/N	Assembly Procedure/ Trim Code
		A	B	C		Body	Contact		
13	1	.560	.375	.065	05	Gold	Gold	1311031G053-000	H/01
13	2	.500	.375	.065	05	Gold	Gold (C)	1311031G053-003	I/01
13	3	.750	.415	.437	67	Gold	Gold	1317031G673-000	H/02
13	4	.750	.440	.312	67	Gold	Gold (C)	1317031G677-000	***
13	5	.700	.415	.437	67	Gold	Gold (C)	1317031G673-003	I/01
14	1	.500	.375	.065	05	Gold	Gold	1311025G053-000	H/01
14	2	.500	.375	.065	05	Gold	Gold (C)	1311025G053-001	I/01
14	3	.750	.415	.437	67	Gold	Gold	1317025G673-000	H/02
14	4	.750	.440	.312	67	Gold	Gold (C)	1317025G677-000	***
14	5	.750	.415	.437	67	Gold	Gold (C)	1317025G673-001	I/01

- See page 209 for cable groups.
- Assembly procedures start on page 210.
- \*\*\*Contact factory for cable assembly instructions.
- See page 208 for mounting dimensions.
- (C) in contact plating column indicates captive contact.

## Straight Jack - For Flexible Cable

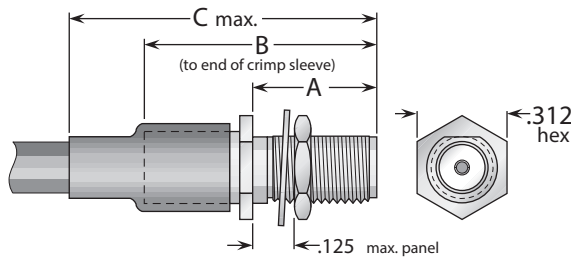


**Figure 1**  
(Crimp type, shown with supplied heat-shrink tubing)

See page 195 for MIL-PRF-39012 QPL version.

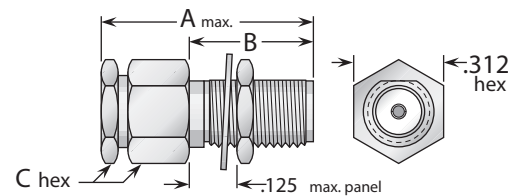
Cable Group	Figure	Dimensions			Plating		Delta P/N	Assembly Procedure/ Trim Code
		A	B	C	Body	Contact		
5	1	.800	1.125	.250	Gold	Gold	1308017G000-000	K/03
5	1	.800	1.125	.250	Passivated	Gold	1308017K000-000	K/03
6	1	.800	1.125	.250	Gold	Gold	1308013G000-000	K/03
6	1	.800	1.125	.250	Passivated	Gold	1308013K000-000	K/03
9	1	.800	1.125	.250	Gold	Gold	1308037G000-000	K/03
9	1	.800	1.125	.250	Passivated	Gold	1308037K000-000	K/03

## Bulkhead Jack - For Flexible Cable



**Figure 1**  
(Crimp type, shown with supplied heat-shrink tubing)

See page 196 for MIL-PRF-39012 QPL version.

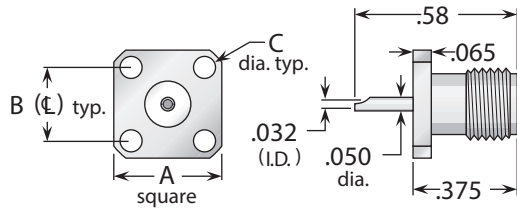


**Figure 2**  
(Clamp type)

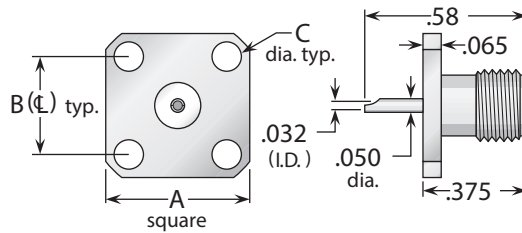
Cable Group	Fig.	Dimensions			Mounting Figure	Plating		Delta P/N	Assembly Procedure/ Trim Code
		A	B	C		Body	Contact		
5	1	.450	.940	1.25	67	Gold	Gold	1319017G670-000	K/04
5	1	.450	.940	1.25	67	Passivated	Gold	1319017K670-000	K/04
6	1	.450	.940	1.25	67	Gold	Gold	1319013G670-000	K/04
6	1	.450	.940	1.25	67	Passivated	Gold	1319013K670-000	K/04
9	1	.450	.940	1.25	67	Gold	Gold	1319037G670-000	K/04
9	1	.450	.940	1.25	67	Passivated	Gold	1319037K670-000	K/04
10	1	.450	.940	1.25	67	Gold	Gold	1319100G670-000	K/04
10	1	.450	.940	1.25	67	Passivated	Gold	1319100K670-000	K/04
5, 6	2	.850	.450	.312	67	Gold	Gold (C)	1316015G675-000	***
5, 6	2	.850	.450	.312	67	Passivated	Gold (C)	1316015K675-000	***
9	2	.850	.450	.312	67	Gold	Gold (C)	1316037G675-000	***
9	2	.850	.450	.312	67	Passivated	Gold (C)	1316037K675-000	***

- See page 209 for cable groups.
- Assembly procedures start on page 210.
- \*\*\*Contact factory for cable assembly instructions.
- See page 208 for mounting dimensions.
- (C) in contact plating column indicates captive contact.

## Panel Jack Receptacle - Solder Pot Contact

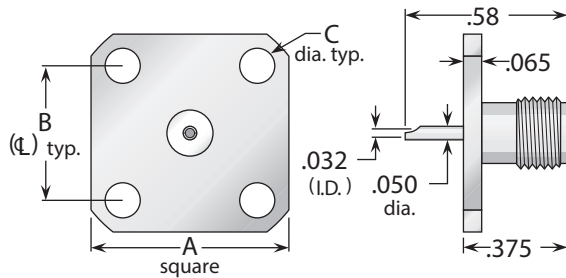


**Figure 1**  
(3/8" square flange)

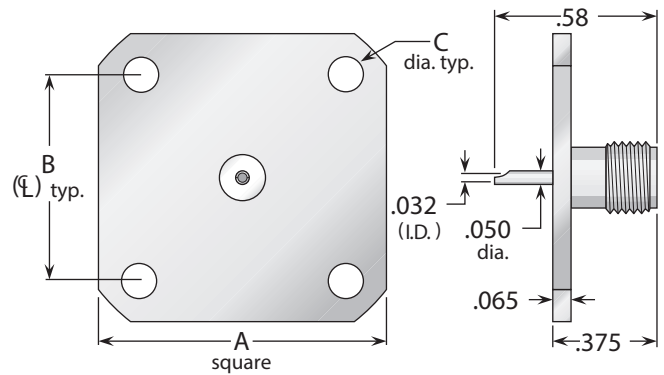


**Figure 2**  
(1/2" square flange, SMA standard flange size)

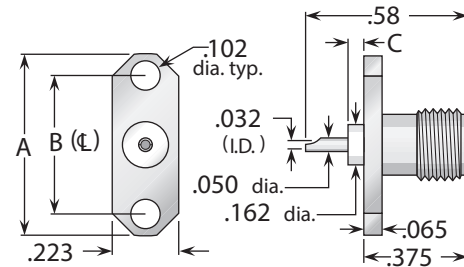
See page 197 for MIL-PRF-39012 QPL version.



**Figure 3**  
(11/16" square flange, interchangeable with BNC and TNC standard flange size)



**Figure 4**  
(1" square flange, interchangeable with type N standard flange size)



**Figure 5**  
(2-hole flange)

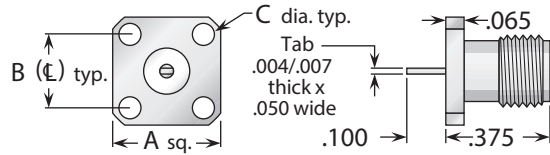
See page 197 for MIL-PRF-39012 QPL version.

Figure	Dimensions			Mounting Figure	Plating		Delta P/N
	A	B	C		Body	Contact	
1	.375	.250	.067	91	Gold	Gold (C)	1313000G911-000
1	.375	.250	.067	91	Passivated	Gold (C)	1313000K911-000
2	.500	.340	.102	05	Gold	Gold (C)	1313000G051-000
2	.500	.340	.102	05	Passivated	Gold (C)	1313000K051-002
3	.687	.500	.125	09	Gold	Gold (C)	1313000G091-000
3	.687	.500	.125	09	Passivated	Gold (C)	1313000K091-000
4	1.00	.718	.125	33	Gold	Gold (C)	1313000G331-000
4	1.00	.718	.125	33	Passivated	Gold (C)	1313000K331-000
5	.625	.481	.025	92	Gold	Gold (C)	1313000G921-000
5	.625	.481	.025	92	Passivated	Gold (C)	1313000K921-000
5	.625	.481	.000	92	Gold	Gold (C)	1313000G921-002
5	.625	.481	.000	92	Passivated	Gold (C)	1313000K921-002

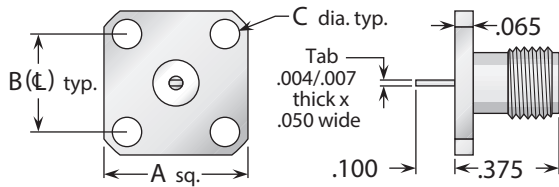
- See page 208 for mounting dimensions.
- (C) in contact plating column indicates captive contact (epoxy captivated).
- All items available with other flange, contact, and insulator configurations.



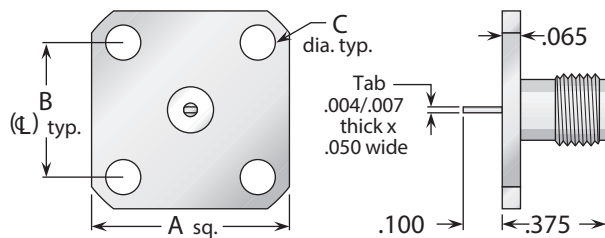
## Panel Jack Receptacle - Tab Contact



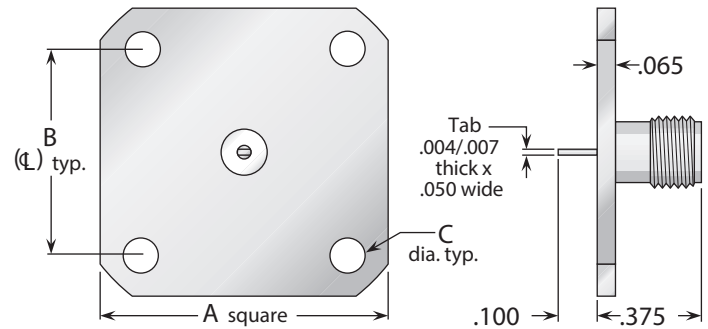
**Figure 1**  
(3/8" square flange)



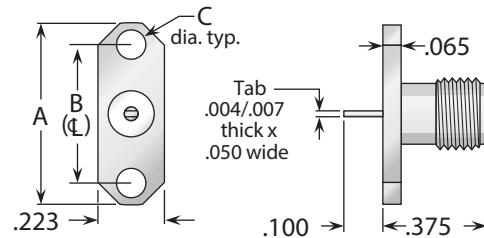
**Figure 2**  
(1/2" square flange, SMA standard flange size)



**Figure 3**  
(11/16" square flange, interchangeable with BNC and TNC standard flange size)



**Figure 4**  
(1" square flange, interchangeable with type N standard flange size)

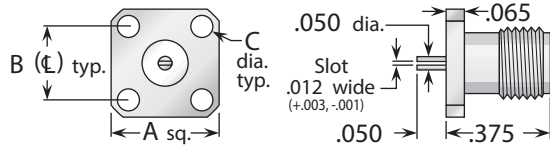


**Figure 5**  
(2-hole flange)

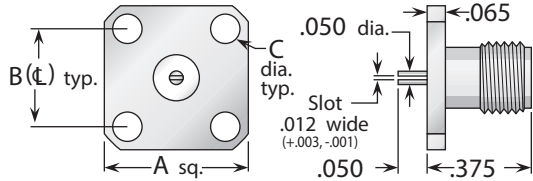
Figure	Dimensions			Mounting Figure	Plating		Delta P/N
	A	B	C		Body	Contact	
1	.375	.250	.067	91	Gold	Gold	1358000G910-002
1	.375	.250	.067	91	Passivated	Gold	1358000K910-002
1	.375	.250	.067	91	Gold	Gold (C)	1358000G911-059
1	.375	.250	.067	91	Passivated	Gold (C)	1358000K911-059
2	.500	.340	.102	05	Gold	Gold	1358000G050-005
2	.500	.340	.102	05	Passivated	Gold	1358000K050-005
2	.500	.340	.102	05	Gold	Gold (C)	1358000G051-003
2	.500	.340	.102	05	Passivated	Gold (C)	1358000K051-003
3	.687	.500	.125	09	Gold	Gold	1358000G090-001
3	.687	.500	.125	09	Passivated	Gold	1358000K090-001
3	.687	.500	.125	09	Gold	Gold (C)	1358000G091-008
3	.687	.500	.125	09	Passivated	Gold (C)	1358000K091-008
4	1.00	.718	.125	33	Gold	Gold	1358000G330-001
4	1.00	.718	.125	33	Passivated	Gold	1358000K330-001
4	1.00	.718	.125	33	Gold	Gold (C)	1358000G331-002
4	1.00	.718	.125	33	Passivated	Gold (C)	1358000K331-002
5	.625	.481	.102	92	Gold	Gold	1358000G920-003
5	.625	.481	.102	92	Passivated	Gold	1358000K920-003
5	.625	.481	.102	92	Gold	Gold (C)	1358000G921-063
5	.625	.481	.102	92	Passivated	Gold (C)	1358000K921-063

- See page 208 for mounting dimensions.
- (C) in contact plating column indicates captive contact (epoxy captivated).
- All items available with other flange, contact, and insulator configurations.

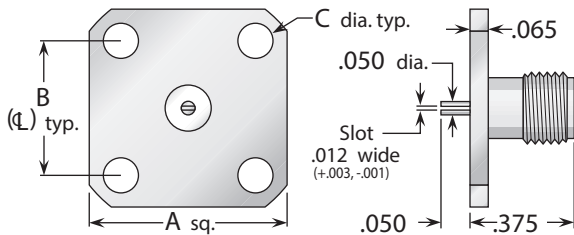
## Panel Jack Receptacle - Slotted Contact



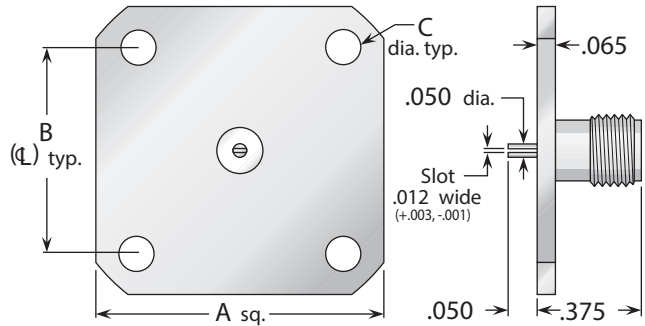
**Figure 1**  
(3/8" square flange)



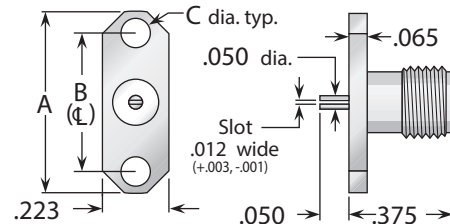
**Figure 2**  
(1/2" square flange, SMA standard flange size)



**Figure 3**  
(11/16" square flange, interchangeable with BNC and TNC standard flange size)



**Figure 4**  
(1" square flange, interchangeable with type N standard flange size)



**Figure 5**  
(2-hole flange)

### Other Standard Slot Widths

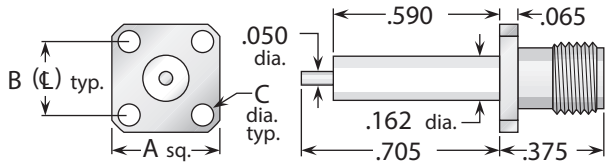
Our other standard slot widths for these connectors (.018" and .036") are readily available—call for part numbers.

Figure	Dimensions			Mounting Figure	Plating		Delta P/N
	A	B	C		Body	Contact	
1	.375	.250	.067	91	Gold	Gold	1343000G910-003
1	.375	.250	.067	91	Passivated	Gold	1343000K910-003
1	.375	.250	.067	91	Gold	Gold (C)	1343000G911-006
1	.375	.250	.067	91	Passivated	Gold (C)	1343000K911-006
2	.500	.340	.102	05	Gold	Gold	1343000G050-006
2	.500	.340	.102	05	Passivated	Gold	1343000K050-006
2	.500	.340	.102	05	Gold	Gold (C)	1343000G051-021
2	.500	.340	.102	05	Passivated	Gold (C)	1343000K051-021
3	.687	.500	.125	09	Gold	Gold	1343000G090-001
3	.687	.500	.125	09	Passivated	Gold	1343000K090-001
3	.687	.500	.125	09	Gold	Gold (C)	1343000G091-006
3	.687	.500	.125	09	Passivated	Gold (C)	1343000K091-006
4	1.00	.718	.125	33	Gold	Gold	1343000G330-006
4	1.00	.718	.125	33	Passivated	Gold	1343000K330-006
4	1.00	.718	.125	33	Gold	Gold (C)	1343000G331-011
4	1.00	.718	.125	33	Passivated	Gold (C)	1343000K331-011
5	.625	.481	.102	92	Gold	Gold	1343000G920-004
5	.625	.481	.102	92	Passivated	Gold	1343000K920-004
5	.625	.481	.102	92	Gold	Gold (C)	1343000G921-006
5	.625	.481	.102	92	Passivated	Gold (C)	1343000K921-006

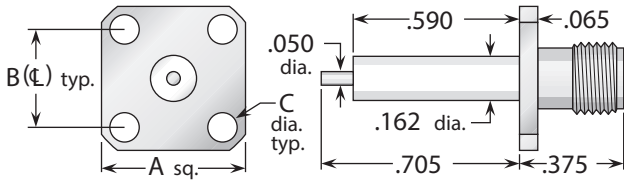
- See page 208 for mounting dimensions.
- (C) in contact plating column indicates captive contact (epoxy captivated).
- All items available with other flange, contact, and insulator configurations.



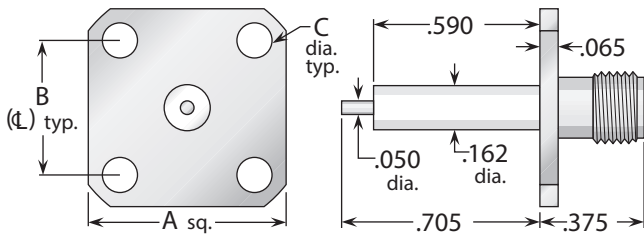
## Panel Jack Receptacle - Post Contact



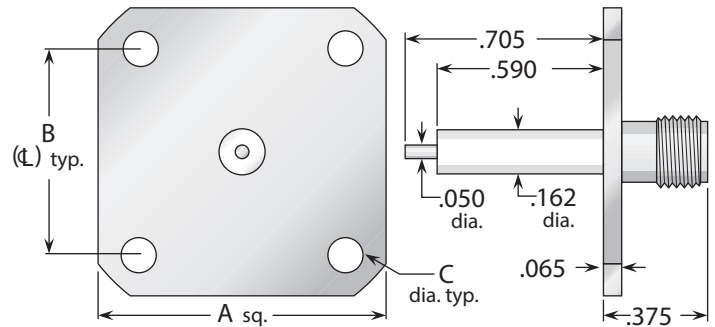
**Figure 1**  
(3/8" square flange)



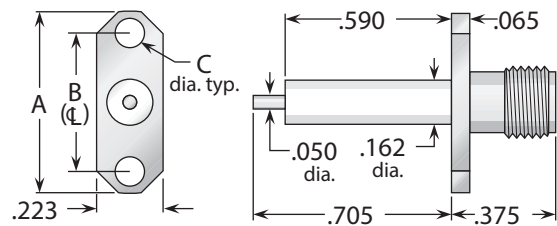
**Figure 2**  
(1/2" square flange, SMA standard flange size)



**Figure 3**  
(11/16" square flange, interchangeable with BNC and TNC standard flange size)



**Figure 4**  
(1" square flange, interchangeable with type N standard flange size)

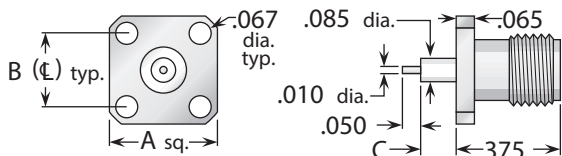


**Figure 5**  
(2-hole flange)

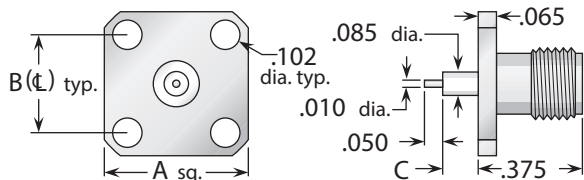
Figure	Dimensions			Mounting Figure	Plating		Delta P/N
	A	B	C		Body	Contact	
1	.375	.250	.067	91	Gold	Gold	1358000G910-003
1	.375	.250	.067	91	Passivated	Gold	1358000K910-003
1	.375	.250	.067	91	Gold	Gold (C)	1358000G911-061
1	.375	.250	.067	91	Passivated	Gold (C)	1358000K911-061
2	.500	.340	.102	05	Gold	Gold	1358000G050-000
2	.500	.340	.102	05	Passivated	Gold	1358000K050-004
2	.500	.340	.102	05	Gold	Gold (C)	1358000G051-000
2	.500	.340	.102	05	Passivated	Gold (C)	1358000K051-000
3	.687	.500	.125	09	Gold	Gold	1358000G090-000
3	.687	.500	.125	09	Passivated	Gold	1358000K090-000
3	.687	.500	.125	09	Gold	Gold (C)	1358000G091-014
3	.687	.500	.125	09	Passivated	Gold (C)	1358000K091-014
4	1.00	.718	.125	33	Gold	Gold	1358000G330-000
4	1.00	.718	.125	33	Passivated	Gold	1358000K330-000
4	1.00	.718	.125	33	Gold	Gold (C)	1358000G331-003
4	1.00	.718	.125	33	Passivated	Gold (C)	1358000K331-003
5	.625	.481	.102	92	Gold	Gold	1358000G920-000
5	.625	.481	.102	92	Passivated	Gold	1358000K920-000
5	.625	.481	.102	92	Gold	Gold (C)	1358000G921-010
5	.625	.481	.102	92	Passivated	Gold (C)	1358000K921-010

• See page 208 for mounting dimensions. • (C) in contact plating column indicates captive contact (epoxy captivated).  
• All items available with other flange, contact, and insulator configurations.

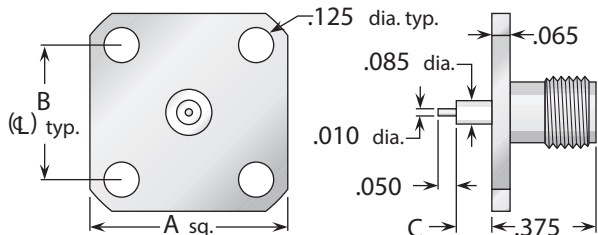
## Panel Jack Receptacle - Post Contact (For Microstrip)



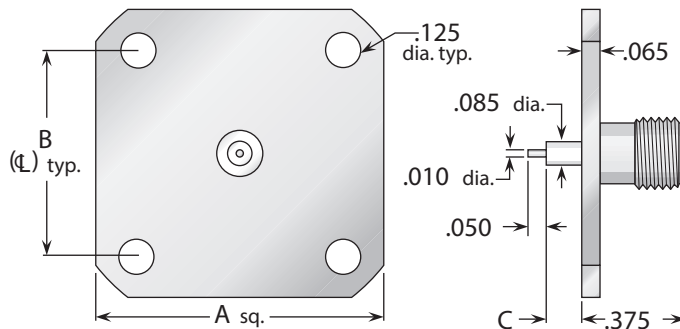
**Figure 1**  
(3/8" square flange)



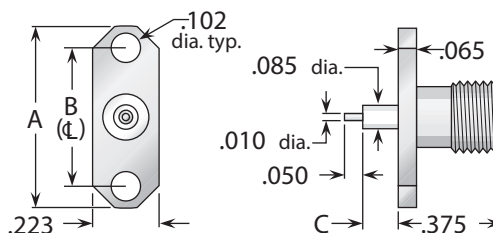
**Figure 2**  
(1/2" square flange, SMA standard flange size)



**Figure 3**  
(11/16" square flange, interchangeable with BNC and TNC standard flange size)



**Figure 4**  
(1" square flange, interchangeable with type N standard flange size)



**Figure 5**  
(2-hole flange)

Figure	Dimensions			Mounting Figure	Plating		Delta P/N
	A	B	C		Body	Contact	
1	.375	.250	.057	91	Gold	Gold (C)	1358000G911-014
1	.375	.250	.057	91	Passivated	Gold (C)	1358000K911-014
1	.375	.250	.125	91	Gold	Gold (C)	1358000G911-085
1	.375	.250	.125	91	Passivated	Gold (C)	1358000K911-085
2	.500	.340	.057	05	Gold	Gold (C)	1358000G051-019
2	.500	.340	.057	05	Passivated	Gold (C)	1358000K051-019
2	.500	.340	.125	05	Gold	Gold (C)	1358000G051-128
2	.500	.340	.125	05	Passivated	Gold (C)	1358000K051-128
3	.687	.500	.057	09	Gold	Gold (C)	1358000G091-015
3	.687	.500	.057	09	Passivated	Gold (C)	1358000K091-015
3	.687	.500	.125	09	Gold	Gold (C)	1358000G091-016
3	.687	.500	.125	09	Passivated	Gold (C)	1358000K091-016
4	1.00	.718	.057	33	Gold	Gold (C)	1358000G331-004
4	1.00	.718	.057	33	Passivated	Gold (C)	1358000K331-004
4	1.00	.718	.125	33	Gold	Gold (C)	1358000G331-005
4	1.00	.718	.125	33	Passivated	Gold (C)	1358000K331-005
5	.625	.481	.057	92	Gold	Gold (C)	1358000G051-035
5	.625	.481	.057	92	Passivated	Gold (C)	1358000K051-035
5	.625	.481	.125	92	Gold	Gold (C)	1358000G051-034
5	.625	.481	.125	92	Passivated	Gold (C)	1358000K051-034

- See page 208 for mounting dimensions.
- (C) in contact plating column indicates captive contact (epoxy captivated).
- All items available with other flange, contact, and insulator configurations.

## Right Angle Panel Jack Receptacle

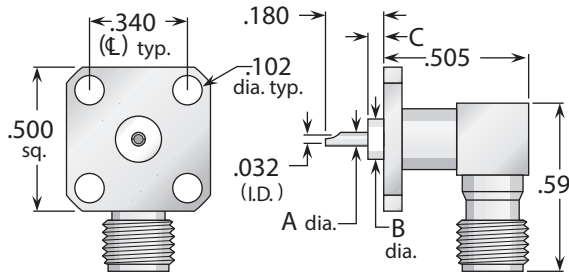


Figure 1 (Solder pot contact)

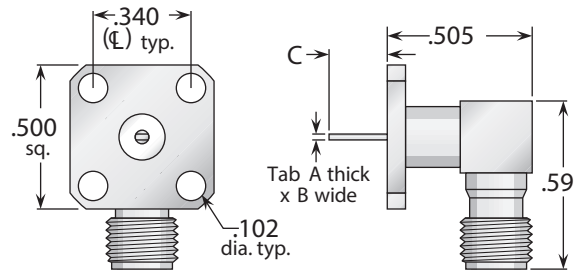


Figure 2 (Tab contact)

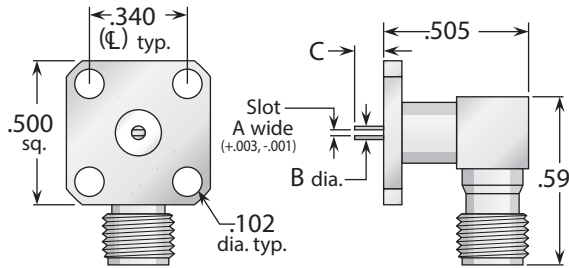


Figure 3 (Slotted contact)

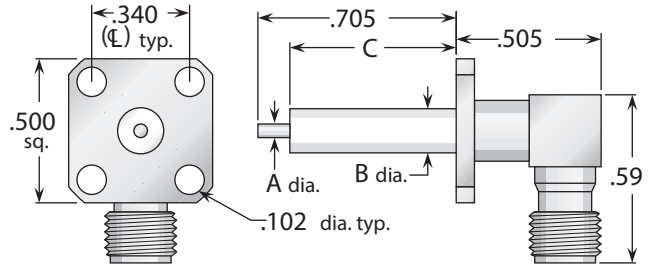


Figure 4 (Post contact)

Figure	Dimensions			Mounting Figure	Plating		Delta P/N
	A	B	C		Body	Contact	
1	.050	.162	.062	05	Gold	Gold (C)	1315000G050-000
1	.050	.162	.062	05	Passivated	Gold (C)	1315000K050-000
2	.004/.007	.050	.100	05	Gold	Gold (C)	1364000G051-015
2	.004/.007	.050	.100	05	Passivated	Gold (C)	1364000K051-015
3	.012	.050	.102	05	Gold	Gold (C)	1366000G051-017
3	.012	.050	.050	05	Passivated	Gold (C)	1366000K051-017
3	.018	.050	.050	05	Gold	Gold (C)	1366000G051-018
3	.018	.050	.050	05	Passivated	Gold (C)	1366000K051-018
3	.036	.050	.050	05	Gold	Gold (C)	1366000G051-019
3	.036	.050	.050	05	Passivated	Gold (C)	1366000K051-019
4	.050	.162	.590	05	Gold	Gold (C)	1364000G051-016
4	.050	.162	.590	05	Passivated	Gold (C)	1364000K051-016

## Stripline Receptacle

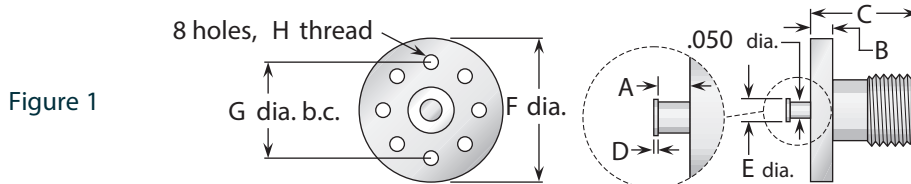


Figure 1

Figure	Dimensions								Plating		Delta P/N
	A	B	C	D	E	F	G	H	Body	Contact	
1	.031	.085	.375	.010	.072	.562	.438	#2-56	Gold	Gold	1357000G000-012
1	.031	.085	.375	.010	.072	.562	.438	#2-56	Passivated	Gold	1357000K000-012
1	.063	.085	.375	.010	.072	.562	.438	#2-56	Gold	Gold	1357000G000-002
1	.063	.085	.375	.010	.072	.562	.438	#2-56	Passivated	Gold	1357000K000-002
1	.125	.085	.375	.010	.072	.562	.438	#2-56	Gold	Gold	1357000G000-006
1	.125	.085	.375	.010	.072	.562	.438	#2-56	Passivated	Gold	1357000K000-006

- See page 208 for mounting dimensions.
- (C) in contact plating column indicates captive contact.
- All items available with other flange, contact, and insulator configurations.

## Bulkhead Jack Receptacles

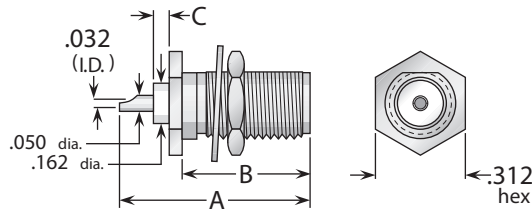


Figure 1

(Rear mount, solder pot contact, no mounting gasket)

See page 197 for MIL-PRF-39012 QPL version.

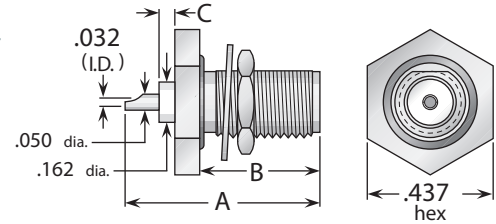


Figure 2

(Rear mount, solder pot contact, with mounting gasket)

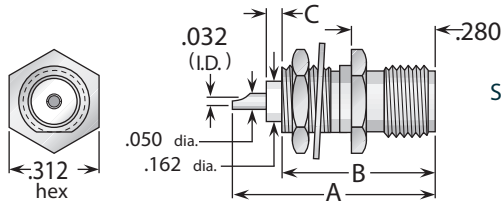


Figure 3

(Front mount, solder pot contact, no mounting gasket)

See page 197 for MIL-PRF-39012 QPL version.

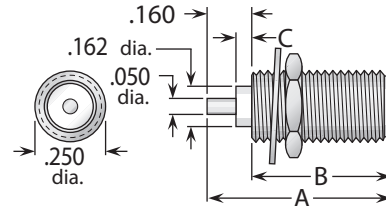


Figure 4

(Round body, post contact)

Figure	Dimensions			Max. Panel	Mounting Figure	Plating		Delta P/N
	A	B	C			Body	Contact	
1	.670	.450	.000	.125	67	Gold	Gold (C)	1320000G671-000
1	.670	.450	.000	.125	67	Passivated	Gold (C)	1320000K671-000
1	.670	.450	.062	.125	67	Gold	Gold (C)	1320000G821-002
1	.670	.450	.062	.125	67	Passivated	Gold (C)	1320000K821-000
2	.670	.415	.062	.093	67	Gold	Gold (C)	1320000G821-000
2	.670	.415	.062	.093	67	Passivated	Gold (C)	1320000K821-011
3	.670	.500	.062	.125	67	Gold	Gold (C)	1320000G671-005
3	.670	.500	.062	.125	67	Passivated	Gold (C)	1320000K671-005
4	.660	.500	.076	.125	82	Gold	Gold	1321000G820-003
4	.660	.500	.076	.125	82	Passivated	Gold	1321000K820-003
4	.660	.500	.076	.125	82	Gold	Gold (C)	1321000G821-000
4	.660	.500	.076	.125	82	Passivated	Gold (C)	1321000K821-014
4	.660	.500	.000	.125	82	Gold	Gold (C)	1321000G821-065
4	.660	.500	.000	.125	82	Passivated	Gold (C)	1321000K821-065

## Printed-Circuit Board Receptacles - Through-Hole Mount

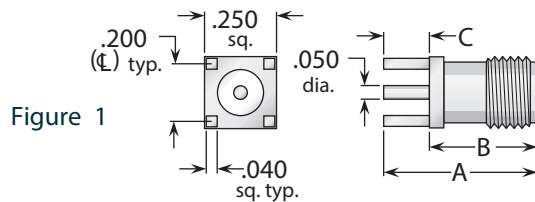


Figure 1

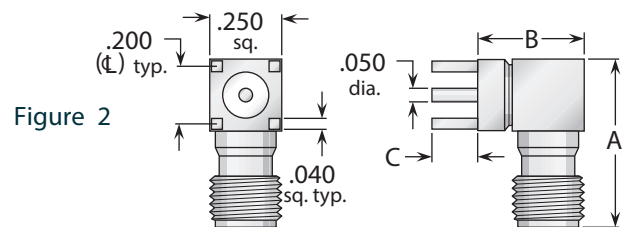


Figure 2

Figure	Dimensions			Max. Board	Mounting Figure	Plating		Delta P/N
	A	B	C			Body	Contact	
1	.530	.375	.155	.125	PCB05	Gold	Gold (C)	1367000G911-000
2	.583	.375	.155	.125	PCB05	Gold	Gold (C)	1369000G000-000

See page 208 for mounting dimensions. • (C) in contact plating column indicates captive contact (epoxy captivated).  
All items available with other contact and insulator configurations.

## Delta Edge Mount Receptacles

These connectors eliminate the need for drilling P.C. boards for mounting. Edge mounting provides design versatility, particularly in daughterboard configurations.

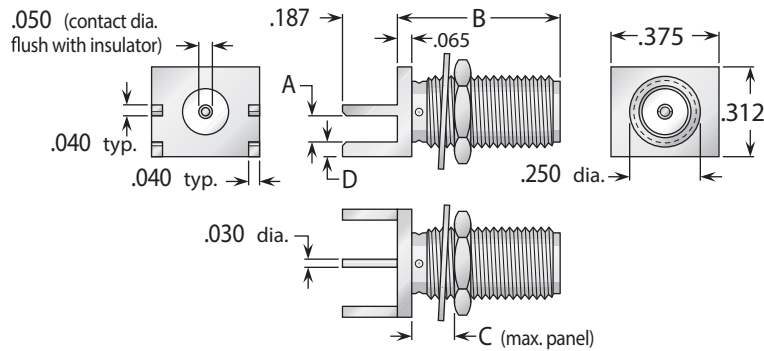
In addition, styles with bulkhead mounting allow P.C. boards to be attached directly to component housings or panels, eliminating the expense of adapters, cable assemblies, and/or additional board mounting hardware. Bulkhead mounted types are available with mounting gaskets as an option (see picture).

Delta SMA edge mount receptacles feature gold-plated brass bodies for low cost, with gold-plated beryllium copper center contacts. Insulators and contacts are mechanically captivated to meet MIL-PRF-39012 requirements. All are available with stainless-steel bodies.



Bulkhead jack with mounting gasket

### Edge Mount P.C. Board Receptacles - Bulkhead Jack



Board Thickness	Dimensions				Plating		Delta P/N
	A	B	C	D	Body	Contact	
.042	.048	.500	.125	.093	Gold	Gold (C)	1367000G91P-021
.047	.053	.500	.125	.088	Gold	Gold (C)	1367000G91P-022
.062	.068	.500	.125	.073	Gold	Gold (C)	1367000G91P-006
.062	.068	.820	.425	.073	Gold	Gold (C)	1367000G91P-023

### Edge Mount P.C. Board Receptacles - Straight Jack

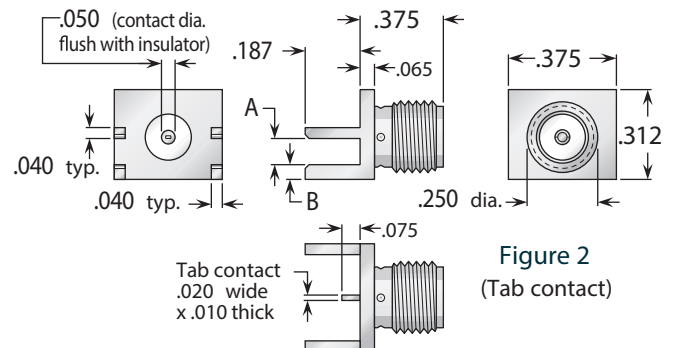
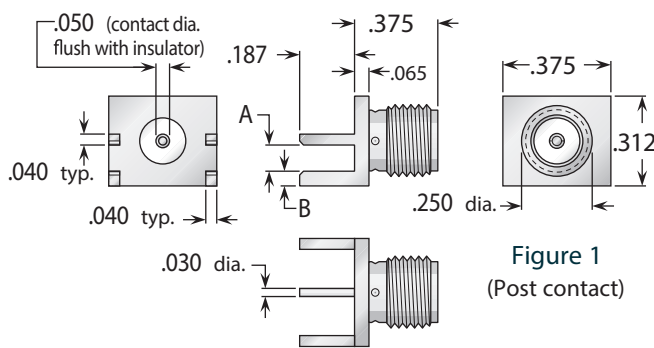
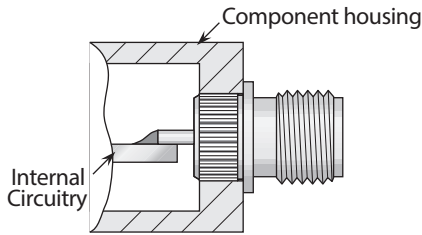


Figure	Board Thickness	Dimensions		Plating		Delta P/N
		A	B	Body	Contact	
1	.042	.048	.093	Gold	Gold (C)	1367000G91P-026
1	.047	.053	.088	Gold	Gold (C)	1367000G91P-027
1	.062	.068	.073	Gold	Gold (C)	1367000G91P-000
2	.042	.048	.103	Gold	Gold (C)	1367000G91P-024
2	.047	.053	.098	Gold	Gold (C)	1367000G91P-025
2	.062	.068	.083	Gold	Gold (C)	1367000G91P-020

• (C) in contact plating column indicates captive contact (mechanical captivation).

• See page 114 for plug types.

## Press Mount Receptacles



### Delta PressMount Receptacles

These connectors eliminate the need for complicated mounting hole patterns and mounting hardware.

They are simply pressed into a single through hole, and the precisely-engineered knurled mounting section provides retention strength far greater than normal mating and unmating forces. An integral shoulder provides a positive stop when mounting.

PressMounts are available for a wide variety of Delta connector series, and can be used in packages as small as the outer diameter of the connector body.

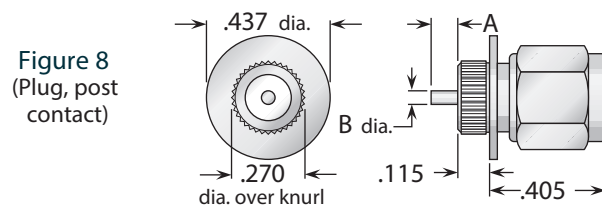
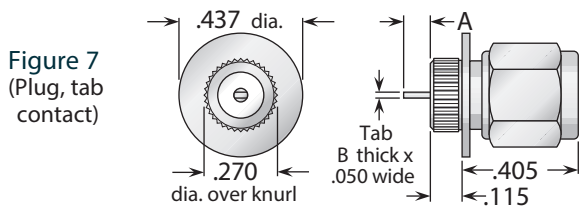
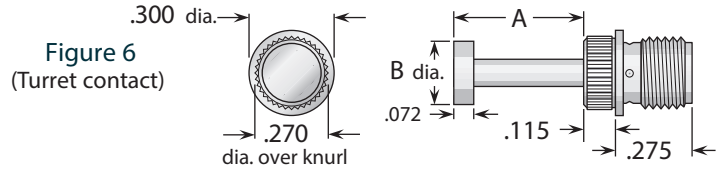
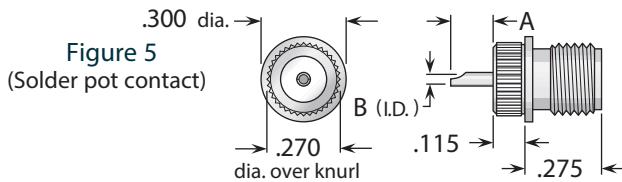
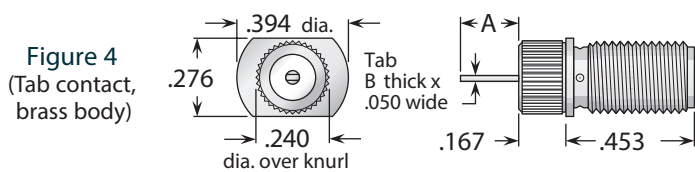
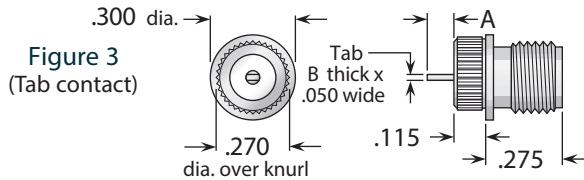
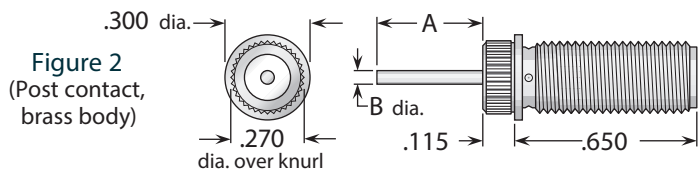
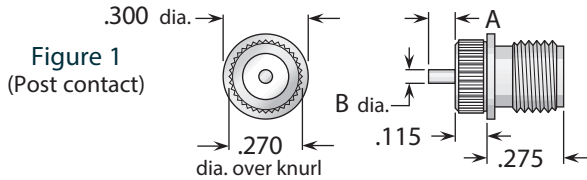


Figure	Dimensions		Min. Panel	Mounting Hole	Plating		Delta P/N
	A	B			Body	Contact	
1	.062	.050	.100	.267 ±.001 dia.	Passivated	Gold (C)	1320000K911-002
2	.390	.050	.100	.267 ±.001 dia.	Gold	Gold (C)	1320000G911-076
3	.100	.005/.008	.100	.267 ±.001 dia.	Passivated	Gold (C)	1320000K911-003
4	.120	.005/.008	.100	.237 ±.001 dia.	Gold	Gold (C)	1320000G911-084
5	.200	.032	.100	.267 ±.001 dia.	Passivated	Gold (C)	1320000K911-004
6	.465	.250	.100	.267 ±.001 dia.	Gold	Gold (C)	1320000G911-085
6	.425	.250	.100	.267 ±.001 dia.	Gold	Gold (C)	1320000G911-078
7	.100	.005/.008	.100	.267 ±.001 dia.	Passivated	Gold (C)	1324000K911-003
8	.062	.050	.100	.267 ±.001 dia.	Passivated	Gold (C)	1324000K911-002

(C) in contact plating column indicates captive contact (mechanical captivation).



## Edge Mount P.C. Board Receptacles - Straight Plugs

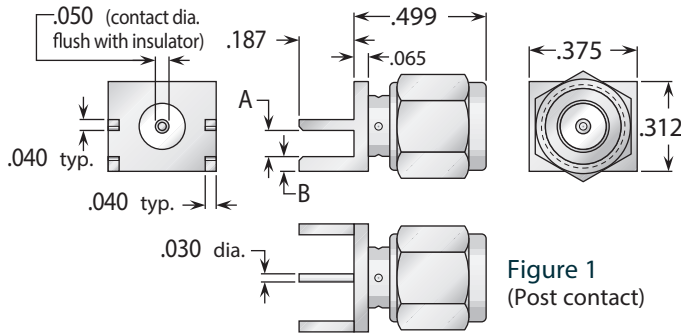


Figure 1  
(Post contact)

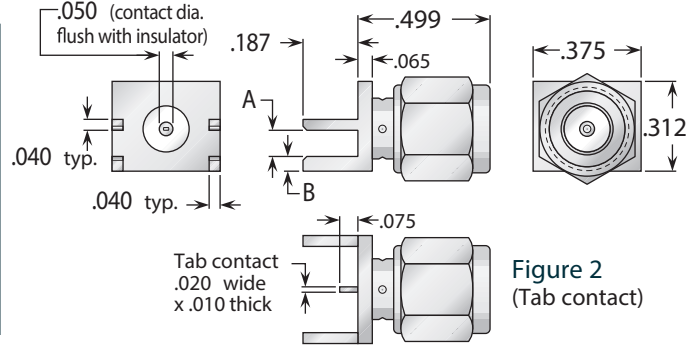


Figure 2  
(Tab contact)

Figure	Board Thickness	Dimensions		Plating		Delta P/N
		A	B	Body	Contact	
1	.042	.048	.093	Gold	Gold (C)	1368000G91P-004
1	.047	.053	.088	Gold	Gold (C)	1368000G91P-005
1	.062	.068	.073	Gold	Gold (C)	1368000G91P-006
2	.042	.048	.103	Gold	Gold (C)	1368000G91P-001
2	.047	.053	.098	Gold	Gold (C)	1368000G91P-002
2	.062	.068	.083	Gold	Gold (C)	1368000G91P-003

## Panel Plug Receptacles - Solder Pot Contact

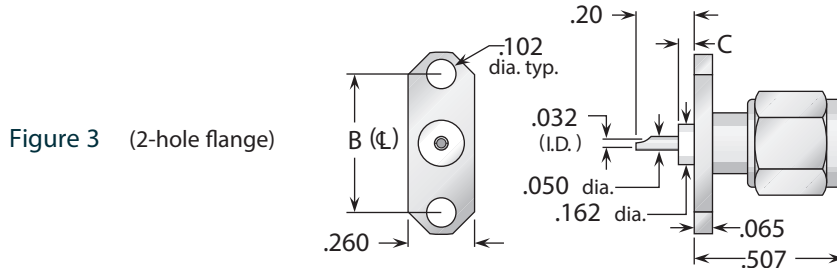
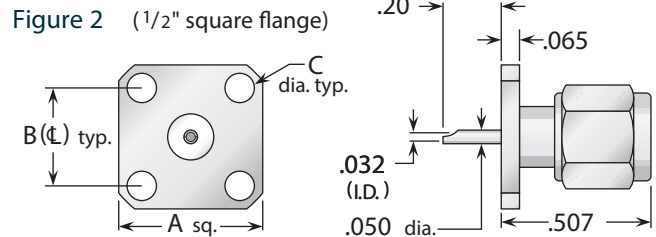
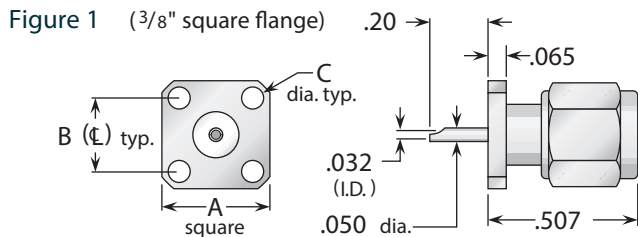


Figure 3 (2-hole flange)

Figure	Dimensions			Mounting Figure	Plating		Delta P/N
	A	B	C		Body	Contact	
1	.375	.250	.067	91	Gold	Gold (C)	1359000G911-013
1	.375	.250	.067	91	Passivated	Gold (C)	1359000K911-013
2	.500	.340	.102	05	Gold	Gold (C)	1359000G051-010
2	.500	.340	.102	05	Passivated	Gold (C)	1359000K051-010
3	.625	.481	.000	92A	Gold	Gold (C)	1359000G921-017
3	.625	.481	.000	92A	Passivated	Gold (C)	1359000K921-017
3	.625	.481	.025	92A	Passivated	Gold (C)	1359000G921-018
3	.625	.481	.025	92A	Passivated	Gold (C)	1359000K921-018

• See page 208 for mounting dimensions. • (C) in contact plating column indicates captive contact.

## Panel Plug Receptacles - Tab Contact

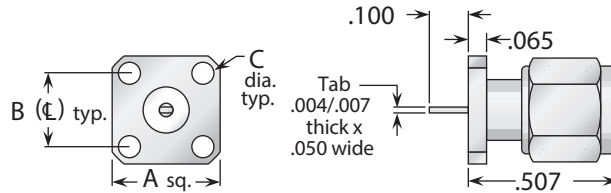


Figure 1  
( $\frac{3}{8}$ " square flange)

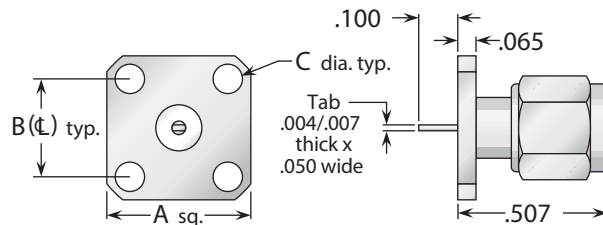


Figure 2  
( $\frac{1}{2}$ " square flange)

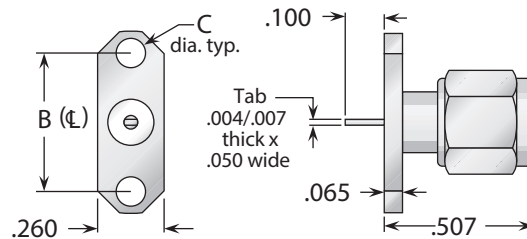
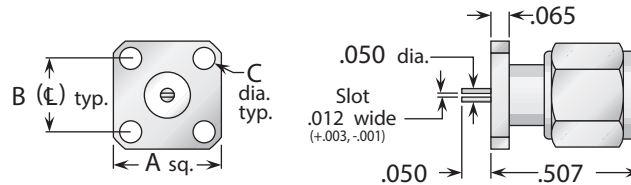


Figure 3  
(2-hole flange)

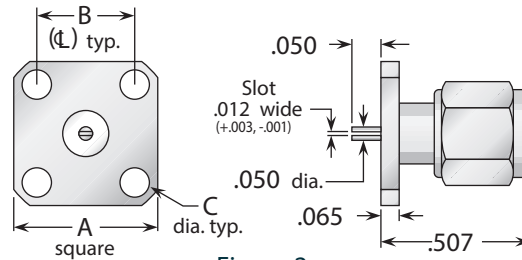
Figure	Dimensions			Mounting Figure	Plating		Delta P/N
	A	B	C		Body	Contact	
1	.375	.250	.067	91	Gold	Gold	1359000G910-002
1	.375	.250	.067	91	Passivated	Gold	1359000K910-002
1	.375	.250	.067	91	Gold	Gold (C)	1359000G911-014
1	.375	.250	.067	91	Passivated	Gold (C)	1359000K911-014
2	.500	.340	.102	05	Gold	Gold	1359000G050-005
2	.500	.340	.102	05	Passivated	Gold	1359000K050-005
2	.500	.340	.102	05	Gold	Gold (C)	1359000G051-045
2	.500	.340	.102	05	Passivated	Gold (C)	1359000K051-045
3	.625	.481	.102	92A	Gold	Gold	1359000G920-001
3	.625	.481	.102	92A	Passivated	Gold	1359000K920-001
3	.625	.481	.102	92A	Gold	Gold (C)	1359000G921-019
3	.625	.481	.102	92A	Passivated	Gold (C)	1359000K921-019

- See page 208 for mounting dimensions.
- (C) in contact plating column indicates captive contact (epoxy captivated).
- All items available with other flange, contact, and insulator configurations.

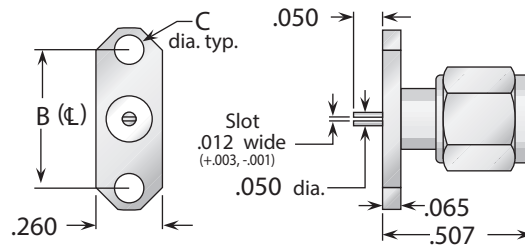
## Panel Plug Receptacles - Slotted Contact



**Figure 1**  
(3/8" square flange)



**Figure 2**  
(1/2" square flange)



**Figure 3**  
(2-hole flange)

### Other Standard Slot Widths

Our other standard slot widths for these connectors (.018" and .036") are readily available—call for part numbers.

Figure	Dimensions			Mounting Figure	Plating		Delta P/N
	A	B	C		Body	Contact	
1	.375	.250	.067	91	Gold	Gold	1359000G910-004
1	.375	.250	.067	91	Passivated	Gold	1359000K910-004
1	.375	.250	.067	91	Gold	Gold (C)	1359000G911-023
1	.375	.250	.067	91	Passivated	Gold (C)	1359000K911-023
2	.500	.340	.102	05	Gold	Gold	1359000G050-007
2	.500	.340	.102	05	Passivated	Gold	1359000K050-007
2	.500	.340	.102	05	Gold	Gold (C)	1359000G051-038
2	.500	.340	.102	05	Passivated	Gold (C)	1359000K051-038
3	.625	.481	.102	92A	Gold	Gold	1359000G920-002
3	.625	.481	.102	92A	Passivated	Gold	1359000K920-002
3	.625	.481	.102	92A	Gold	Gold (C)	1359000G921-020
3	.625	.481	.102	92A	Passivated	Gold (C)	1359000K921-020

See page 208 for mounting dimensions. • (C) in contact plating column indicates captive contact (epoxy captivated).

All items available with other flange, contact, and insulator configurations.

## Panel Plug Receptacle - Post Contact

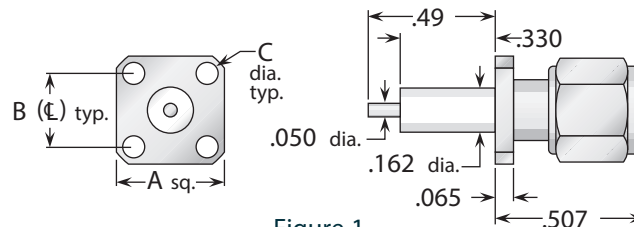


Figure 1  
(3/8" square flange)

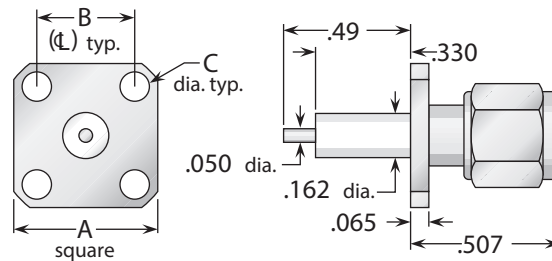


Figure 2  
(1/2" square flange)

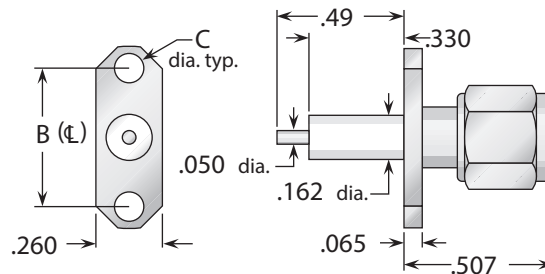


Figure 3  
(2-hole flange)

Figure	Dimensions			Mounting Figure	Plating		Delta P/N
	A	B	C		Body	Contact	
1	.375	.250	.067	91	Gold	Gold	1359000G910-003
1	.375	.250	.067	91	Passivated	Gold	1359000K910-003
1	.375	.250	.067	91	Gold	Gold (C)	1359000G911-015
1	.375	.250	.067	91	Passivated	Gold (C)	1359000K911-015
2	.500	.340	.102	05	Gold	Gold	1359000G050-000
2	.500	.340	.102	05	Passivated	Gold	1359000K050-002
2	.500	.340	.102	05	Gold	Gold (C)	1359000G051-004
2	.500	.340	.102	05	Passivated	Gold (C)	1359000K051-004
3	.625	.481	.102	92A	Gold	Gold	1323000G920-000
3	.625	.481	.102	92A	Passivated	Gold	1323000K920-000
3	.625	.481	.102	92A	Gold	Gold (C)	1323000G921-001
3	.625	.481	.102	92A	Passivated	Gold (C)	1323000K921-001

- See page 208 for mounting dimensions.
- (C) in contact plating column indicates captive contact (epoxy captivated).
- All items available with other flange, contact, and insulator configurations.

## Dummy Receptacles

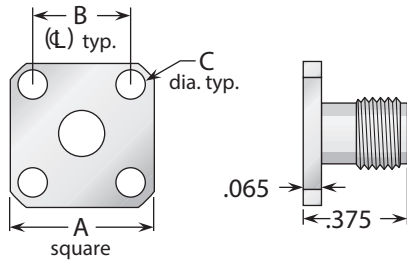


Figure 1  
(1/2" square flange)

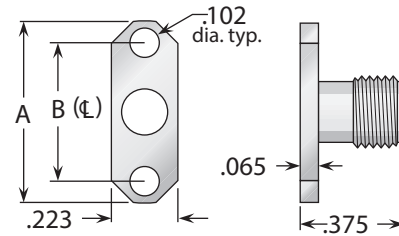


Figure 2  
(2-hole flange)

Figure	Dimensions			Mounting Figure	Plating		Delta P/N
	A	B	C		Body	Contact	
1	.500	.340	.102	05	Gold	—	1363000G050-001
1	.500	.340	.102	05	Passivated	—	1363000K050-002
2	.625	.481	.102	92	Gold	—	1363000G920-000
2	.625	.481	.102	92	Passivated	—	1363000K920-000

## Dust Caps

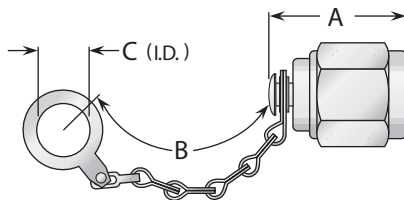


Figure 1  
(Shown with safety chain)

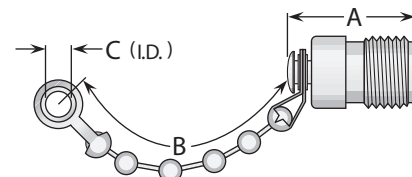


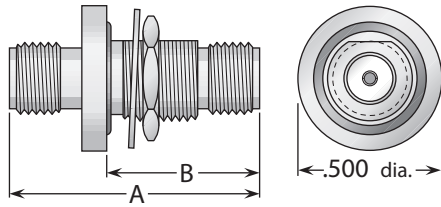
Figure 2  
(Shown with bead chain)

See page 195 for MIL-PRF-39012 QPL versions.

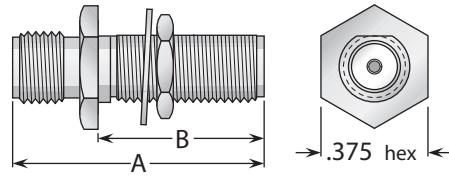
Figure	Dimensions			Features	Plating		Delta P/N
	A	B	C		Body	Contact	
1	.500	2.25	.144	Bead chain	Gold	—	1332000G000-000
1	.500	2.25	.144	Bead chain	Passivated	—	1332000K000-000
1	.275	—	—	No chain	Passivated	—	1332000K00A-001
1	.500	3.25	.281	Safety chain	Passivated	—	1332000K00B-003
1	.330	—	—	No chain / shorting type	Passivated	Passivated	1332000K00C-000
2	.500	2.25	.144	Bead chain	Gold	—	1333000G000-000
2	.500	2.25	.144	Bead chain	Passivated	—	1333000K000-000
2	.390	—	—	No chain	Passivated	—	1333000K00A-000

• See page 208 for mounting dimensions. • Dust caps are available with other chain styles and lengths.

## Bulkhead Mounted Jack-Jack Adapters (Connects Two Plugs)



**Figure 1**  
(Hermetically sealed, with mounting gasket)

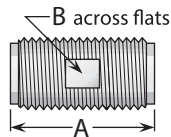


**Figure 2**  
(Non-hermetic, no mounting gasket)

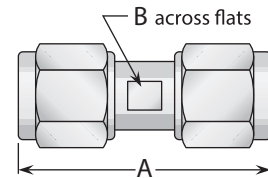
Figure	Dimensions		Max. Panel	Mounting Figure	Plating		Delta P/N
	A	B			Body	Contact	
1	.875	.555	.190	66	Gold	Gold (C)	1326000G678-000
2	.875	.575	.250	67	Gold	Gold (C)	1326000G821-000
2	.875	.575	.250	67	Passivated	Gold (C)	1326000K821-001

## Straight Adapters

**Figure 1**  
(Straight jack-jack;  
connects two plugs)



**Figure 2**  
(Straight plug-plug;  
connects two jacks)



**Figure 3**  
(Straight jack-plug;  
connects one plug  
and one jack)

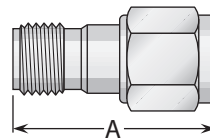


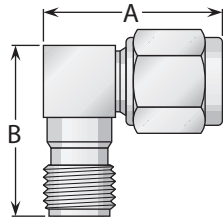
Figure	Dimensions		Plating		Delta P/N
	A	B	Body	Contact	
1	.500	.218	Gold	Gold (C)	1328000G000-000
1	.500	.218	Passivated	Gold (C)	1328000K000-001
2	.875	.218	Gold	Gold (C)	1327000G000-000
2	.875	.218	Passivated	Gold (C)	1327000K000-002
3	.720	—	Gold	Gold (C)	1334000G000-000
3	.720	—	Passivated	Gold (C)	1334000K000-000

• (C) in contact plating column indicates captive contact.

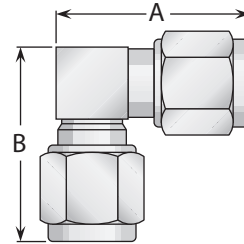
• See page 208 for mounting dimensions.



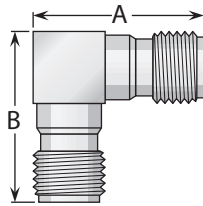
## Right Angle & Tee Adapters



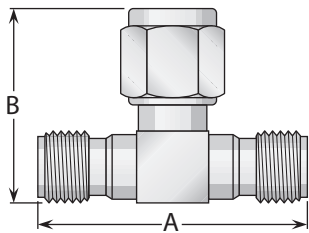
**Figure 1**  
 (Right angle plug-jack;  
 connects one plug and one jack)



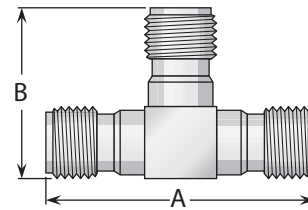
**Figure 2**  
 (Right angle plug-plug;  
 connects two jacks)



**Figure 3**  
 (Right angle jack-jack;  
 connects two plugs)



**Figure 4**  
 (Tee jack-plug-jack;  
 connects two plugs and one jack)



**Figure 5**  
 (Tee jack-jack-jack;  
 connects three plugs)

Figure	Dimensions		Plating		Delta P/N
	A	B	Body	Contact	
1	.625	.585	Gold	Gold (C)	1329000G000-000
1	.625	.585	Passivated	Gold (C)	1329000K000-000
2	.675	.675	Gold	Gold (C)	1337000G000-001
2	.675	.675	Passivated	Gold (C)	1337000K000-001
3	.585	.585	Gold	Gold (C)	1395000G000-000
3	.585	.585	Passivated	Gold (C)	1395000K000-000
4	.920	.630	Gold	Gold (C)	1330000G000-000
4	.920	.630	Passivated	Gold (C)	1330000K000-000
5	1.00	.590	Gold	Gold (C)	1349000G000-000
5	1.00	.590	Passivated	Gold (C)	1349000K000-000

(C) in contact plating column indicates captive contact.

## General Description

Delta E-Line brass SMA connectors are subminiature, 50 Ω impedance connectors with 1/4"-36 threaded coupling. Their use of brass for body parts provides lower cost while retaining electrical performance similar to that of stainless steel SMA counterparts.

If your application does not require the 500 mating cycles of service life provided by stainless steel SMA connectors, E-Line SMAs can fulfill your needs at a reduced cost. For additional economy, nickel-plated bodies can be specified instead of gold plating.

E-Line brass SMA connectors can be used with semi-rigid cables in applications up to 18 GHz, or miniature flexible cables up to 12.4 GHz.

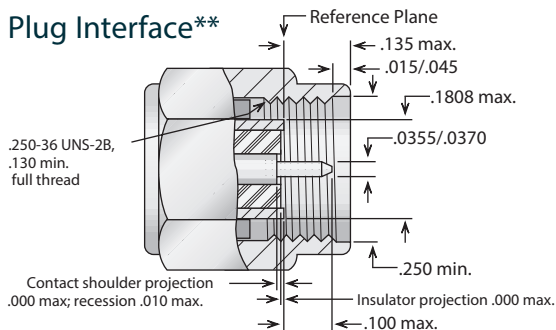
Our E-Line brass SMA product line is still growing, so please call if you don't see what you need.

## E-Line Brass SMA Configurations

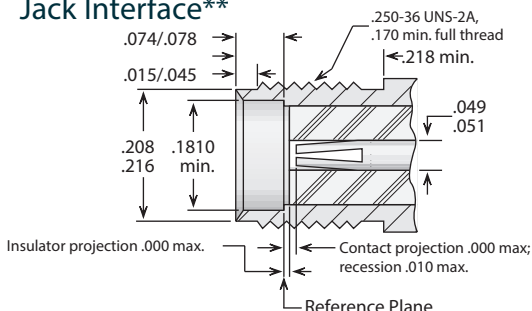
Cable Plugs for Semi-Rigid Cable .....	124	Panel Jack Receptacles (Post Contact) .....	126
Straight Cable Jacks for Semi-Rigid Cable .....	124	Panel Jack Receptacles (Tab Contact) .....	126
Bulkhead Cable Jacks for Semi-Rigid Cable .....	124	Bulkhead Jack Receptacles .....	127
Panel Cable Jacks for Semi-Rigid Cable .....	124	Printed-Circuit Board Receptacles .....	127
Cable Plugs for Flexible Cable .....	125	Panel Plug Receptacles (Solder Pot Contact) .....	128
Straight Cable Jacks for Flexible Cable .....	125	Panel Plug Receptacles (Post Contact) .....	128
Bulkhead Cable Jacks for Flexible Cable .....	125	Panel Plug Receptacles (Tab Contact) .....	128
Panel Jack Receptacles (Solder Pot Contact) .....	126	In-Series Adapters .....	129

## E-Line Brass SMA Specifications\*

### Plug Interface\*\*



### Jack Interface\*\*



\*\*Some proportions altered to illustrate detail.

### Electrical:

Nominal Impedance: 50 ohms.

Frequency Range: DC-18 GHz (with semi-rigid cable);  
DC-12.4 GHz (with flexible cable).

Voltage Rating: 335-500 volts RMS (dependent on cable).

Dielectric Withstanding

Voltage : 500-1500 volts RMS (dependent on cable).

Insulation Resistance: 5,000 megohms.

### Materials/Finishes:

Insulators: Teflon per ASTM D1710.

Male Contacts: Brass per ASTM B16, or  
Beryllium Copper per ASTM B196.

Female Contacts: Beryllium Copper per ASTM B196.

Contact Plating : Gold per MIL-DTL-45204.

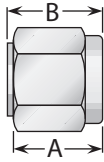
Gaskets: Silicone rubber per ZZ-R-765,  
Class II, Grade 50.

Other Metal Parts: Brass per ASTM B16 or equivalent; gold plated per  
MIL-DTL-45204, or nickel plated per AMS-QQ-N-290.

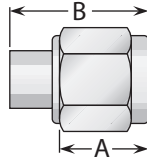
All other specifications are in accordance with the latest issues of MIL-PRF-39012, or MIL-A-55339, or other applicable MIL specifications, and interfaces are in accordance with MIL-STD-348.

\*These specifications are typical and may not apply to all connectors. Detailed specifications for individual connectors are available on request.

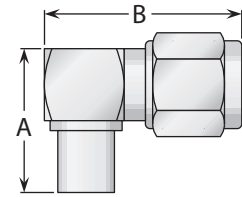
## Straight & Right Angle Plugs - For Semi-Rigid Cable



**Figure 1**  
(Straight plug—direct solder)



**Figure 2**  
(Straight plug—direct solder)

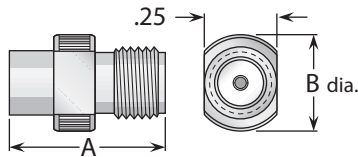


**Figure 3**  
(Right angle plug—direct solder)

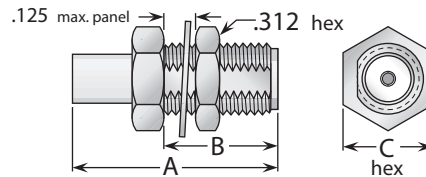
Cable Group	Figure	Dimensions		Plating		Delta P/N	Assembly Procedure/ Trim Code
		A	B	Body	Contact		
13	1	.330	.344	Gold*	None <sup>(1)</sup>	1301031G003-502	G/01
13	2	.459	.330	Gold*	None <sup>(1)</sup>	1301031G003-501	G/01
13	2	.330	.459	Gold*	Gold	1301031G003-500	H/03
13	3	.460	.630	Gold*	Gold (C)	1305031G003-500	J/02
14	2	.330	.459	Gold*	Gold	1301025G003-500	H/03
14	3	.460	.630	Gold*	Gold (C)	1305025G003-500	J/02

<sup>(1)</sup> Cable center conductor used as contact.

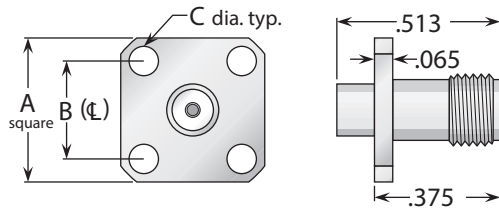
## Straight, Panel & Bulkhead Jacks - For Semi-Rigid Cable



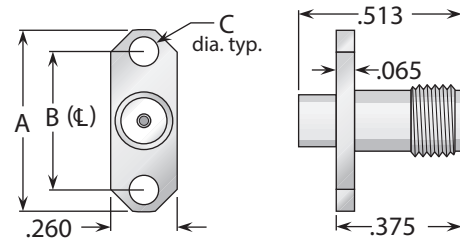
**Figure 1**  
(Straight jack, direct solder)



**Figure 2**  
(Bulkhead mount, direct solder)



**Figure 3**  
(4-hole flange, direct solder)



**Figure 4**  
(2-hole flange, direct solder)

Cable Group	Fig.	Dimensions			Mounting Figure	Plating		Delta P/N	Assembly Procedure/ Trim Code
		A	B	C		Body	Contact		
13	1	.500	.335	—	—	Gold*	Gold	1308031G003-500	H/01
13	2	.850	.500	.312	67	Gold*	Gold	1317031G673-500	H/04
13	3	.500	.340	.102	05	Gold*	Gold	1311031G053-500	H/01
13	4	.625	.481	.102	92A	Gold*	Gold	1311031G923-500	H/01
14	1	.500	.335	—	—	Gold*	Gold	1308025G003-500	H/01
14	2	.850	.500	.312	67	Gold*	Gold	1317025G673-500	H/04
14	3	.500	.340	.102	05	Gold*	Gold	1311025G053-500	H/01
14	4	.625	.481	.102	92A	Gold*	Gold	1311025G923-500	H/01

- \* Also available with nickel-plated body—change G in Delta part number to N.
- (C) in contact plating column indicates captive contact.
- See page 209 for cable groups.
- Assembly procedures start on page 210.
- See page 208 for mounting dimensions.

## Straight & Right Angle Plugs - Crimp Type For Flexible Cable

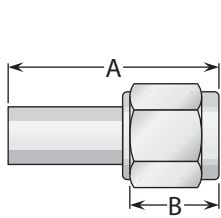


Figure 1  
(Straight plug)

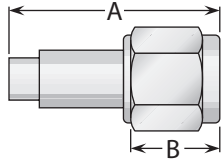


Figure 2  
(Straight plug)

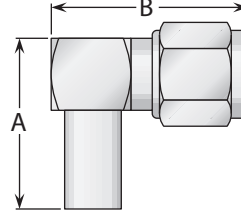


Figure 3  
(Right angle plug)

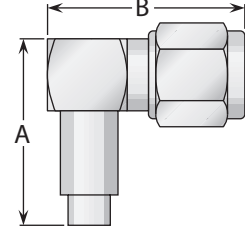


Figure 4  
(Right angle plug)

Cable Group	Figure	Dimensions		Plating		Delta P/N	Assembly Procedure/ Trim Code
		A	B	Body	Contact		
5	1	.880	.330	Gold*	Gold	1303017G000-500	K/05
5	3	.650	.630	Gold*	Gold (C)	1307017G001-500	L/03
6	1	.880	.330	Gold*	Gold	1303013G000-500	K/05
6	3	.650	.630	Gold*	Gold (C)	1307013G001-500	L/03
9	1	.750	.330	Gold*	Gold	1303037G000-500	K/03
9	3	.650	.630	Gold*	Gold (C)	1307037G001-500	L/03
10	1	.750	.330	Gold*	Gold	1303100G000-500	K/06
10	3	.650	.630	Gold*	Gold (C)	1307100G001-500	L/03
11	2	.760	.330	Gold*	Gold	1303038G000-500	***
11	4	.650	.630	Gold*	Gold (C)	1307038G001-500	L/03

## Straight & Bulkhead Jacks - Crimp Type For Flexible Cable

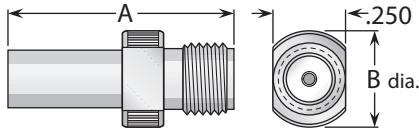


Figure 1 (Straight jack)

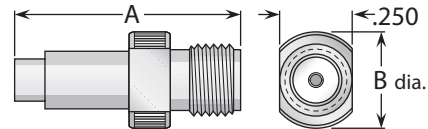


Figure 2 (Straight jack)

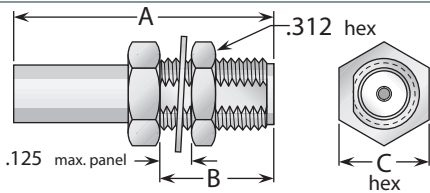


Figure 3 (Bulkhead jack)

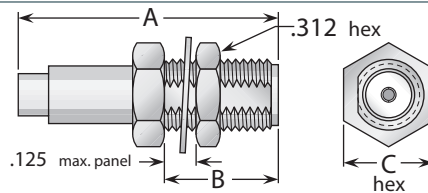
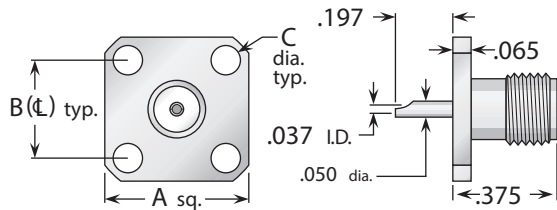


Figure 4 (Bulkhead jack)

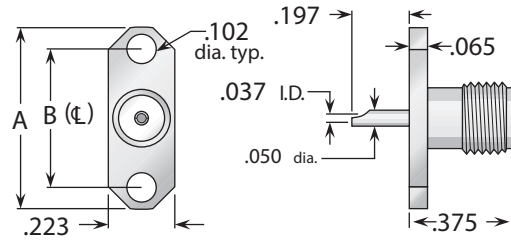
Cable Group	Fig.	Dimensions			Mounting Figure	Plating		Delta P/N	Assembly Procedure/ Trim Code
		A	B	C		Body	Contact		
5	1	.760	.335	—	—	Gold*	Gold	1310017G000-500	K/08
5	3	.990	.500	.312	67	Gold*	Gold	1319017G670-500	K/10
6	1	.760	.335	—	—	Gold*	Gold	1310013G000-500	K/08
6	3	.990	.500	.312	67	Gold*	Gold	1319013G670-500	K/10
9	1	.740	.335	—	—	Gold*	Gold	1310037G000-500	K/08
9	3	.990	.500	.312	67	Gold*	Gold	1319037G670-500	K/10
10	1	.740	.335	—	—	Gold*	Gold	1310100G000-500	K/08
10	3	.990	.500	.312	67	Gold*	Gold	1319100G670-500	K/10
11	2	.740	.335	—	—	Gold*	Gold	1310038G000-500	***
11	4	.990	.500	.312	67	Gold*	Gold	1319038G670-500	***

- \* Also available with nickel-plated body—change G in Delta part number to N.
- (C) in contact plating column indicates captive contact.
- See page 209 for cable groups.
- Assembly procedures start on page 210.
- See page 208 for mounting dimensions.

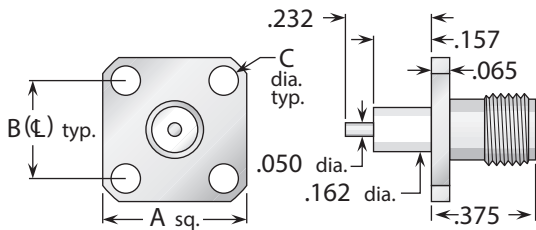
## Panel Jack Receptacles



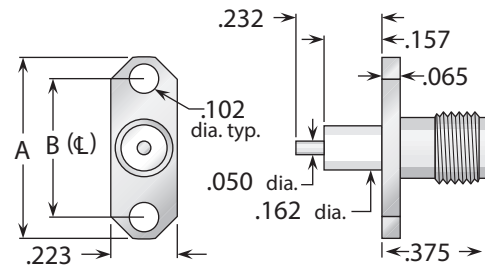
**Figure 1**  
(Solder pot contact—square flange)



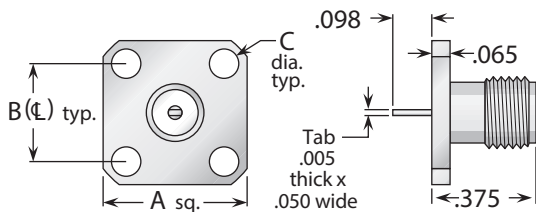
**Figure 2**  
(Solder pot contact—2-hole flange)



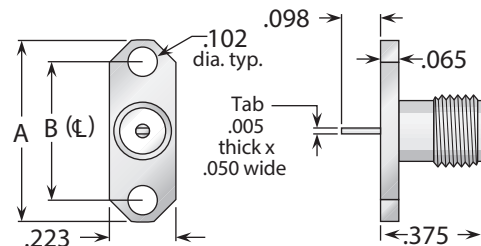
**Figure 3**  
(Post contact—square flange)



**Figure 4**  
(Post contact—2-hole flange)



**Figure 5**  
(Tab contact—square flange)



**Figure 6**  
(Tab contact—2-hole flange)

Figure	Dimensions			Mounting Figure	Plating		Delta P/N
	A	B	C		Body	Contact	
1	.500	.340	.102	05	Gold*	Gold (C)	1313000G051-500
2	.625	.481	.102	92	Gold*	Gold (C)	1313000G921-500
3	.500	.340	.102	05	Gold*	Gold (C)	1358000G051-500
4	.625	.481	.102	92	Gold*	Gold (C)	1358000G921-500
5	.500	.340	.102	05	Gold*	Gold (C)	1358000G051-501
6	.625	.481	.102	92	Gold*	Gold (C)	1358000G921-501

\* Also available with nickel-plated body—change G in Delta part number to N.

• See page 208 for mounting dimensions. • (C) in contact plating column indicates captive contact (mechanical captivation).

• All items available with other flange, contact, and insulator configurations.

## Bulkhead Jack Receptacles

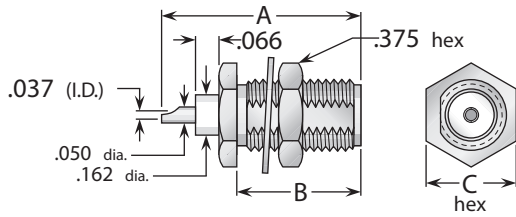


Figure 1 (Rear mount, solder pot contact, no mounting gasket)

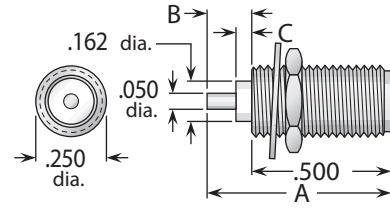


Figure 2 (Round body, post contact)

Figure	Dimensions			Max. Panel	Mounting Figure	Plating		Delta P/N
	A	B	C			Body	Contact	
1	.670	.450	.375	.125	67	Gold	Gold (C)	1321000G671-500
2	.660	.157	.075	.125	82	Gold	Gold (C)	1321000G821-500
2	.620	.118	.000	.125	82	Gold	Gold (C)	1321000G821-501

## Printed-Circuit Board Receptacles

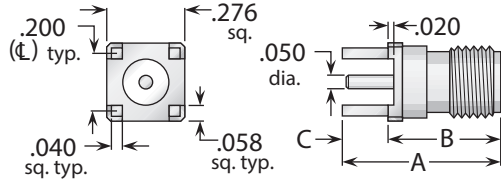


Figure 1 (Straight jack)

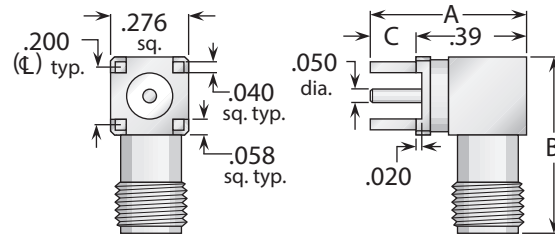


Figure 2 (Right angle jack)

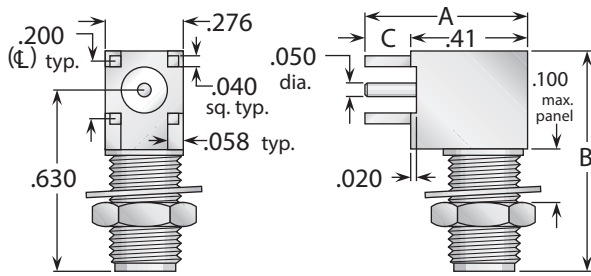


Figure 3 (Right angle bulkhead jack)

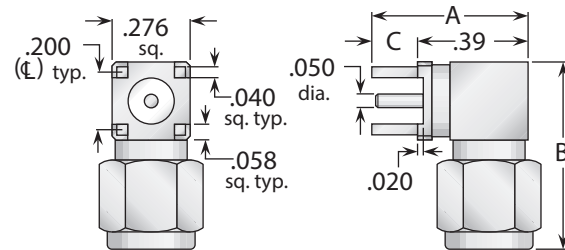


Figure 5 (Right angle plug)

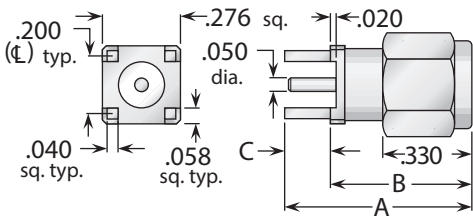


Figure 4 (Straight plug)

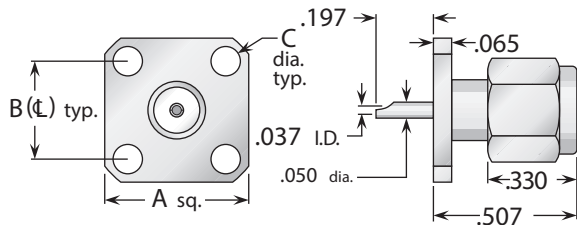
Figure	Dimensions			Max. Board	Mounting Figure	Plating		Delta P/N
	A	B	C			Body	Contact	
1	.550	.394	.155	.125	PCB05	Gold*	Gold (C)	1367000G001-500
2	.540	.594	.155	.125	PCB05	Gold*	Gold (C)	1369000G001-500
3	.560	.756	.155	.125	PCB05/82	Gold*	Gold (C)	1369000G821-500
4	.650	.494	.155	.125	PCB05	Gold*	Gold (C)	1368000G001-500
5	.540	.650	.155	.125	PCB05	Gold*	Gold (C)	1370000G001-500

\* Also available with nickel-plated body—change G in Delta part number to N.

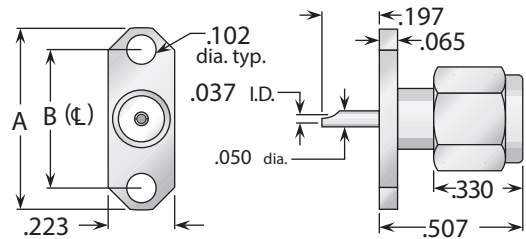
• See page 208 for mounting dimensions. • (C) in contact plating column indicates captive contact (mechanical captivation).



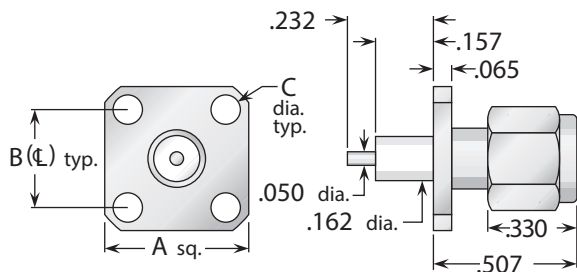
## Panel Plug Receptacles



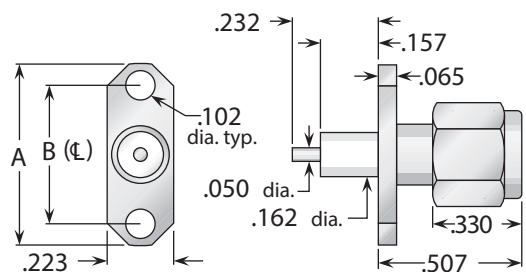
**Figure 1**  
(Solder pot contact—square flange)



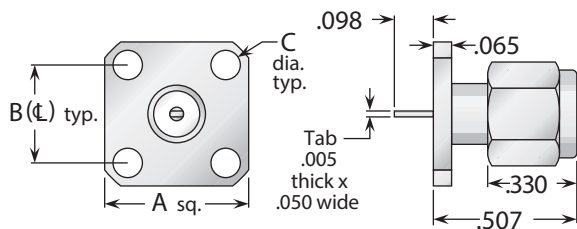
**Figure 2**  
(Solder pot contact—2-hole flange)



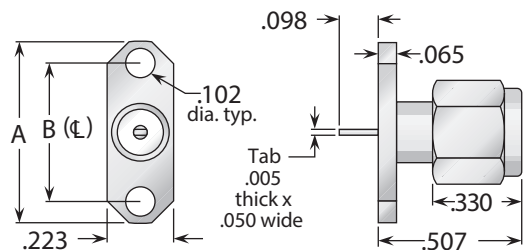
**Figure 3**  
(Post contact—square flange)



**Figure 4**  
(Post contact—2-hole flange)



**Figure 5**  
(Tab contact—square flange)

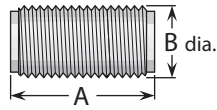


**Figure 6**  
(Tab contact—2-hole flange)

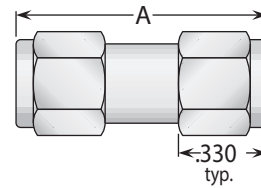
Figure	Dimensions			Mounting Figure	Plating		Delta P/N
	A	B	C		Body	Contact	
1	.500	.340	.102	05	Gold*	Gold (C)	1323000G051-500
2	.625	.481	.102	92	Gold*	Gold (C)	1323000G921-500
3	.500	.340	.102	05	Gold*	Gold (C)	1359000G051-500
4	.625	.481	.102	92	Gold*	Gold (C)	1359000G921-500
5	.500	.340	.102	05	Gold*	Gold (C)	1359000G051-501
6	.625	.481	.102	92	Gold*	Gold (C)	1359000G921-501

- \* Also available with nickel-plated body—change G in Delta part number to N.
- See page 208 for mounting dimensions.
- (C) in contact plating column indicates captive contact (mechanical captivation).
- All items available with other flange, contact, and insulator configurations.

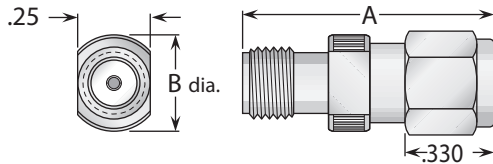
## Straight, Right Angle, & Tee Adapters



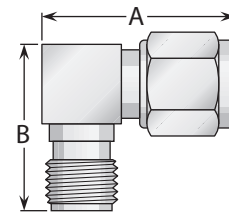
**Figure 1**  
(Straight jack-jack; connects two plugs)



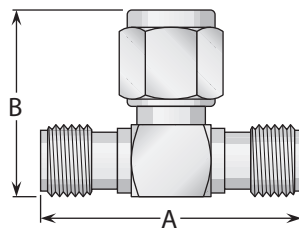
**Figure 2**  
(Straight plug-plug; connects two jacks)



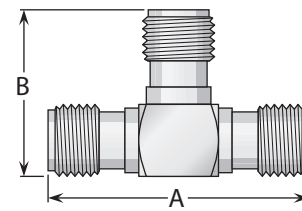
**Figure 3**  
(Straight jack-plug; connects one plug and one jack)



**Figure 4**  
(Right angle plug-jack; connects one plug and one jack)



**Figure 5**  
(Tee jack-plug-jack; connects two plugs and one jack)



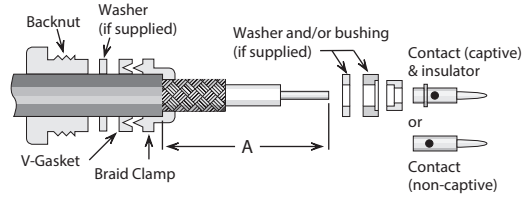
**Figure 6**  
(Tee jack-jack-jack; connects three plugs)

Figure	Dimensions		Plating		Delta P/N
	A	B	Body	Contact	
1	.500	.250	Gold*	Gold (C)	1328000G001-500
2	.900	—	Gold*	Gold (C)	1327000G001-500
3	.860	.335	Gold*	Gold (C)	1334000G001-500
4	.654	.594	Gold*	Gold (C)	1329000G001-500
5	.913	.654	Gold*	Gold (C)	1330000G001-500
6	.913	.594	Gold*	Gold (C)	1338000G001-500

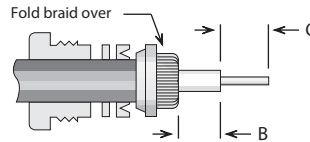
- \* Also available with nickel-plated body—change G in Delta part number to N.
- (C) in contact plating column indicates captive contact (mechanical captivation).

## Assembly Procedure A

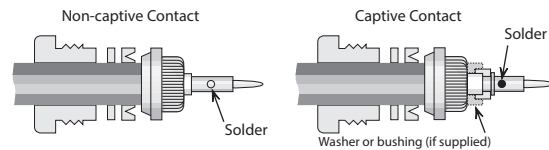
- 1) Trim cable jacket to dimension A.  
Slide backnut, washer, V-gasket, and braid clamp onto cable as shown.  
Cable jacket should bottom on step in braid clamp.



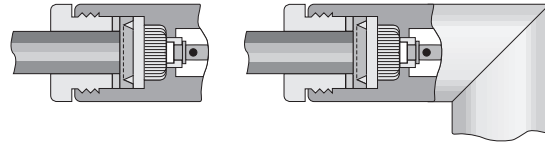
- 2) Comb braid wires out straight and fold back over front shoulder of braid clamp (braid wires should not overlap one another after folding). Trim braid wires flush with step of braid clamp. Trim cable dielectric and center conductor to dimensions B and C.



- 3) If support insulator is provided for RG-62 or 71 cable, insert into hollow in dielectric. Assemble rear bushing or washer (if supplied), rear insulator (if captive contact) and contact, and solder contact to center conductor. Rear of contact should be flush with cable dielectric end. For right angle connectors with access cap, omit this step entirely.



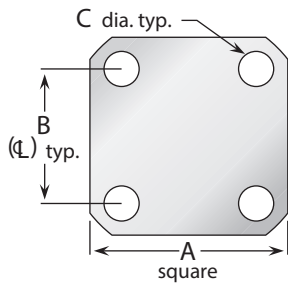
- 4) Insert prepared cable and hardware into body and tighten backnut. For right angle connectors with access cap, solder center conductor into slot in contact and tighten access cap.



### Trim Codes For Assembly Procedure A

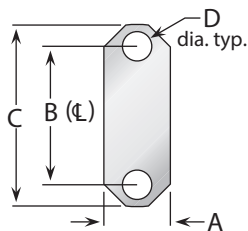
Code	A	B	C	Code	A	B	C
A/01	.375 (3/8)	.047 (3/64)	.203 (13/64)	A/20	.375 (3/8)	.047 (3/64)	.172 (11/64)
A/02	.375 (3/8)	.109 (7/64)	.203 (13/64)	A/21	.500 (1/2)	.313 (5/16)	.172 (11/64)
A/03	.438 (7/16)	.250 (1/4)	.188 (3/16)	A/22	.375 (3/8)	.188 (3/16)	.141 (9/64)
A/04	.281 (9/32)	.047 (3/64)	.125 (1/8)	A/23	.438 (7/16)	.078 (5/64)	.172 (11/64)
A/05	.313 (5/16)	.125 (1/8)	.109 (7/64)	A/24	.500 (1/2)	.094 (3/32)	.141 (9/64)
A/06	.594 (19/32)	.391 (25/64)	.156 (5/32)	A/25	.438 (7/16)	.141 (9/64)	.172 (11/64)
A/07	.375 (3/8)	.047 (3/64)	.125 (1/8)	A/26	.625 (5/8)	.281 (9/32)	.250 (1/4)
A/08	.281 (9/32)	.109 (7/64)	.094 (3/32)	A/27	.688 (11/16)	.281 (9/32)	.125 (1/8)
A/09	.344 (11/32)	.109 (7/64)	.094 (3/32)	A/28	.656 (21/32)	.297 (19/64)	.250 (1/4)
A/10	.406 (13/32)	.109 (7/64)	.203 (13/64)	A/29	.688 (11/16)	.125 (1/8)	.313 (5/16)
A/11	.500 (1/2)	.281 (9/32)	.156 (5/32)	A/30	.688 (11/16)	.469 (15/32)	.156 (5/32)
A/12	.343	.040	.219	A/31	.700 (21/32)	.453 (29/64)	.250 (1/4)
A/13	.375 (3/8)	.125 (1/8)	.156 (5/32)	A/32	.313 (5/16)	.078 (5/64)	.188 (3/16)
A/14	.355	.090	.188 (3/16)	A/33	.250 (1/4)	.078 (5/64)	.094 (3/32)
A/15	.425	.094 (3/32)	.259	A/34	.250 (1/4)	.062 (1/16)	.109 (7/64)
A/16	.328 (21/64)	.094 (3/32)	.188 (3/16)	A/35	.837	.575	.150
A/17	.375 (3/8)	.109 (7/64)	.125 (1/8)	A/36	.450	.250	.150
A/18	.375 (3/8)	.062 (1/16)	.172 (11/64)	A/37	.281	.038	.188
A/19	.375 (3/8)	.188 (3/16)	.094 (3/32)	A/38	.281	.069	.156

## Connector Flanges (Panel Mounted Connectors)



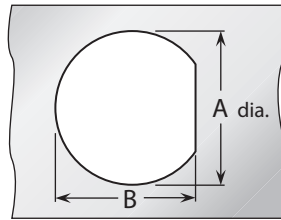
4-hole flanges			
Figure	A	B	C
04	1/2	.360	.089
05	1/2	.340	.102
07	11/16	.500	#3-56 tap
08	11/16	.500	.136
09	11/16	.500	.125
10	11/16	.500	.120
12	11/16	.500	.109
18	3/4	.531	.136
26	1	.718	#6-32 tap
27	1	.718	#4-40 tap
30	1	.718	.166
32	1	.718	.136
32A	1	.718	.136*
33	1	.718	.125
34	1 3/32	.812	.150
36	1 3/16	.906	#6-32 tap
39	1 3/16	.906	.152
40	1 3/16	.906	.125
45	2	1.437	.257
91	.375	.250	.067
91A	.375	.232	.093

\* Countersunk to .245 dia.

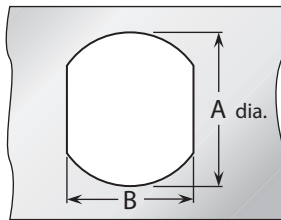


2-hole flanges				
Figure	A	B	C	D
92	.223	.481	.625	.102
92A	.260	.481	.625	.102
95	.640	1.015	1.30	.125

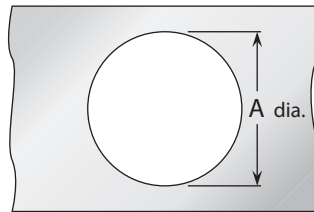
## Panel Cutouts (Bulkhead Mounted Connectors)



D-Hole		
Figure	A	B
51	.755	.723
54	.630	.598
55	.630	.583
57	.557	.531
59	.505	.473
62	.442	.410
63	.407	.362
65	.380	.348
66	.319	.292
67	.255	.236
68	.195	.176

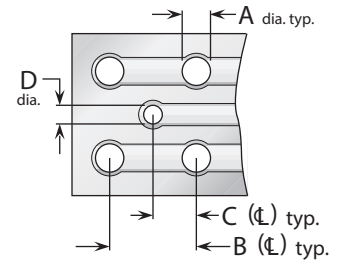


Double D-Hole		
Figure	A	B
69	.755	.692
72	.630	.536
75	.380	.341
84	.319	.278



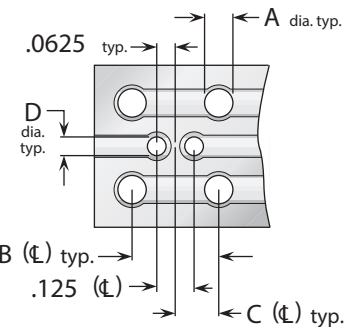
Round Hole	
Figure	A
82	.255
89	.380

## P.C. Board Drilling



(PCB traces are shown for illustrative purpose only, and are not representative of actual circuitry.)

Coaxial connectors				
Figure	A	B	C	D
PCB01	.067	.400	.200	.045
PCB02	.045	.500	.250	.045
PCB03	.067	.300	.150	.035
PCB05	.067	.200	.100	.055
PCB06	.067	.200	.100	.045
PCB07	.045	.177	.088	.045
PCB08	.032	.100	.050	.032



(PCB traces are shown for illustrative purpose only, and are not representative of actual circuitry.)

Twinax Connectors				
Figure	A	B	C	D
PCB04	.045	.500	.250	.045

## Delta Cable Groups

Group	Cables
1	1A RG-5, 5A, 5B, 21, 21A; M17/73, /162
	1B RG-6, 6A; M17/2
	1C RG-143, 143A, 212, 222; M17/73, /112, /162
2	2A RG-8, 8A, 213; M17/74
	2B RG-11, 11A; M17/6
3	3A RG-9, 9A, 9B, 214; M17/75
	3B RG-13A, 216; M17/77
	3C RG-225; M17/127
4	RG-393; M17/127
5	RG-58, 58A, 58C, 141, 141A; M17/28, /111
6	6A RG-55A, 142, 142A, 223, 400; M17/60, /84, /128
	6B RG-55, 55B, 142B; M17/60, /84
7	7A RG-59, 59A, 59B, 62, 62A, 62B, 62C, 210; M17/29, /30, /97
	7B RG-71, 71A, 71B; M17/90
8	8A RG-122; M17/54
	8B RG-180, 180A, 180B, 195; M17/95, /137
9	9A RG-174, 188, 188A, 316; M17/152
	9B RG-179A, 179B, 187, 187A; M17/94, /136
10	Double-Shielded RG-174, 316; M17/152
11	RG-178, 178A, 178B, 196, 196A; M17/93
12	.250" semi-rigid; RG-401; M17/129
13	.141" semi-rigid; RG-402; M17/130
14	.085" semi-rigid; RG-405; M17/133
15	RG-10, 12, 215; M17/6, /74
16	RG-14A, 217; M17/78, /165
17	RG-17A, 218
18	RG-18A, 219
19	RG-115A
20	RG-118A, 228A
21	RG-126
22	RG-302
23	RG-303
24	RG-304
25	Special 8X cable; contact factory for details.
26	Belden 8281
27	RG-108, 108A; M17/45
28	RG-22, 22A, 22B; M17/15
29	Belden 9207; Dearborn 6207; IBM 7362211
30	M17/176
31	AT&T 735A

## Cable Group Finder

Cable	Group	Cable	Group
RG-5, 5A, B	1A	RG-225	3C
RG-6, 6A	1B	RG-228A	20
RG-8, 8A	2A	RG-302	22
RG-9, 9A, B	3A	RG-303	23
RG-10	15	RG-304	24
RG-11, 11A	2B	RG-316	9A
RG-12	15	RG-316DS	10
RG-13A	3B	RG-393	4
RG-14A	16	RG-400	6A
RG-17A	17	RG-401	12
RG-18A	18	RG-402	13
RG-21, 21A	1A	RG-405	14
RG-22, 22A, B	28	M17/2	1B
RG-55, 55B	6B	M17/6	2B
RG-55A	6A	M17/15	28
RG-58, 58A, C	5	M17/28	5
RG-59, 59A, B	7A	M17/29	7A
RG-62, 62A, B, C	7A	M17/30	7A
RG-71, 71A, B	7B	M17/45	27
RG-108, 108A	27	M17/73	1A
RG-115A	19	M17/162	1A
RG-118A	20	M17/112	1C
RG-122	8A	M17/74	2A
RG-126	21	M17/75	3A
RG-141, 141A	5	M17/127	3C
RG-142, 142A	6A	M17/77	3B
RG-142B	6B	M17/60	6A
RG-143, 143A	1C	M18/84	6A
RG-174	9A	M17/128	6A
RG-174DS	10	M17/97	7A
RG-178, 178A, B	11	M17/54	8A
RG-179A, 179B	9B	M17/95	8B
RG-180, 180A, B	8B	M17/137	8B
RG-187, 187A	9B	M17/152	9A
RG-188, 188A	9A	M17/93	11
RG-195	8B	M17/129	12
RG-196, 196A	11	M17/130	13
RG-210	7A	M17/133	14
RG-212	1C	M17/78	16
RG-213	2A	M17/165	16
RG-214	3A	M17/176	30
RG-215	15	AT&T 735A	31
RG-217	16	Belden 8281	26
RG-218	17	Belden 9207	29
RG-219	18	Dearborn 6207	29
RG-222	1C	IBM 7362211	29
RG-223	6A		

Note: MIL-PRF-39012 QPL connectors have cable groups defined by the MIL specification, not the Delta cable groups shown here. See page 185 for M39012 cable groups.

## Warranty

We warrant our parts to be free of defects and workmanship for one year from purchase. During that time we will repair or replace (at our option) any parts found to be defective. The warranty does not apply to parts that have been modified, used in conditions exceeding Seller's, or military specifications, or disassembled. We will not, under any circumstances, be responsible for consequential or incidental damages or installation costs. No other warranties apply, and no other liability may be assumed or extended by representatives or distributors. The terms of the applicable warranty or warranties, as the case may be, as set forth herein are the sole and exclusive warranty terms that shall have any force or effect in the any product order, resulting from the quotation and such terms and in lieu of all other warranties, expressed or implied, including the implied warranties of merchantability and fitness for a particular purpose, which are hereby expressly excluded.



## Returns

Returns will be accepted only with a Return Authorization number issued by Delta, and are subject to inspection and acceptance upon arrival. Restocking charges will be determined prior to issuance of Return Authorization. All claims for shortages must be made within 30 days of receipt by customer.

## Ordering Information

Orders are subject to the terms and conditions on our order acknowledgement, which may only be modified by written agreement prior to sale. Order changes, cancellation, or termination will be accepted only with written approval from Delta Electronics Manufacturing.

## Copyright, Trademarks, & Patents

Entire contents copyright 2017, Delta Electronics Manufacturing Corporation. Reproduction rights are hereby granted for, and specifically limited to, printing or other reproduction of drawings and specifications for inclusion in specification or source control drawings, or purchasing procedures, by Delta customers only.

Heli-Grip<sup>®</sup>, PressMount<sup>®</sup>, and Global Manufacturer logo are trademarks. The Heli-Grip design is covered by U.S. and foreign patents

Delta Electronics Manufacturing Corporation  
416 Cabot Street, P.O. Box 53  
Beverly, MA 01915  
FSCM/CAGE 00795

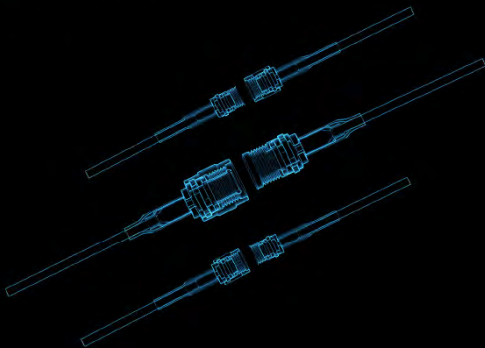




CREATE



COLLABORATE



CONNECT



Delta Electronics Mfg. Corp.

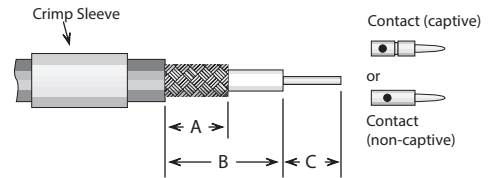
[www.deltarf.com](http://www.deltarf.com)  
978-927-1060  
[sales@deltarf.com](mailto:sales@deltarf.com)

PO Box 53  
416 Cabot St.  
Beverly, MA 01915

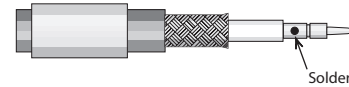


## Assembly Procedure B

- 1) Trim cable per chart. Slide crimp sleeve back onto cable.



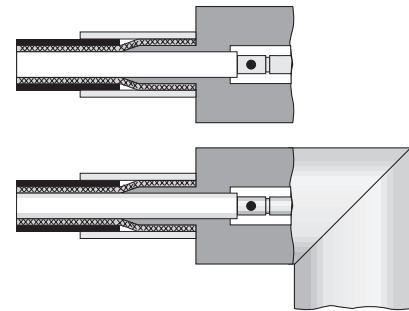
- 2) If support insulator is provided for RG-62 or 71 cable, insert into hollow in dielectric. Solder contact onto center conductor; back of contact flush with trimmed end of cable dielectric (omit this step for right angle connectors with access caps). Flare cut end of braid slightly by rotating dielectric.



- 3) Insert cable/contact into rear of body, with all braid wires on outside of crimp tail.
  - a) For captive contact connectors, push cable in until contact snaps into insulator.
  - b) For noncaptive contact connectors, push cable in until cable dielectric bottoms in connector.
  - c) For right angle or tee connectors with access caps, push cable in until end of braid touches connector body shoulder, and cable center conductor rests in contact slot.

Trim excess braid wires even with shoulder of body. Slide crimp sleeve forward until flush with body and crimp (see page 211 for hex die sizes).

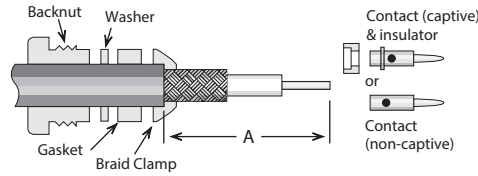
For right angle or tee connectors with access caps: Solder center conductor into contact slot, assemble insulator disc (if supplied), then press cap into body until seated or screw into place.



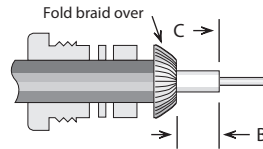
## Trim Codes For Assembly Procedure B

Code	A	B	C	Code	A	B	C
B/01	.320	.470	.140	B/20	.250	.375	.156
B/02	.422	.578	.172	B/21	.425	.550	.156
B/03	.406	.500	.187	B/22	.375	.500	.156
B/04	.285	.505	.140	B/23	.281	.469	.125
B/05	.335	.460	.140	B/24	.250	.700	.109
B/06	.187	.437	.219	B/25	.343	.775	.125
B/07	.422	.610	.156	B/26	.343	.437	.109
B/08	.422	.562	.219	B/27	.313	.437	.187
B/09	.313	.610	.203	B/28	.219	.271	.078
B/10	.280	.436	.187	B/29	.200	.320	.060
B/11	.430	.542	.156	B/30	.500	.650	.219
B/12	.300	.434	.156	B/31	.350	.840	.150
B/13	.300	.447	.156	B/32	.175	.260	.095
B/14	.420	.645	.187	B/33	.195	.270	.045
B/15	.300	.420	.120	B/34	.150	.250	.105
B/16	.312	.609	.125	B/35	.195	.280	.170
B/17	.250	.500	.156	B/36	.150	.325	.090
B/18	.437	.562	.109	B/37	.195	.295	.075
B/19	.343	.437	.156	B/38	.150	.225	.095
				B/39	.250	.300	.135

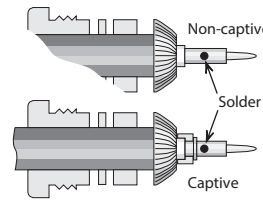
## Assembly Procedure C



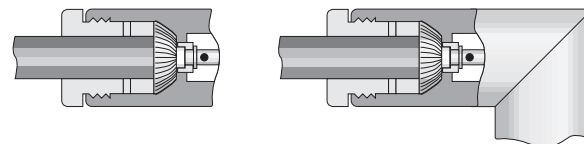
- 1) Trim cable jacket to dimension A. Slide backnut, washer, gasket, and braid clamp onto cable as shown. Cable jacket should bottom on step in braid clamp.



- 2) Comb braid wires out straight and fold back over front shoulder of braid clamp (braid wires should not overlap one another after folding). Trim braid wires flush with edge of braid clamp. Trim cable dielectric and center conductor to dimensions B and C.



- 3) If support insulator is provided for RG-62 or 71 cable, insert into hollow in dielectric. Assemble rear insulator (if captive contact) and contact, and solder contact to center conductor. Rear of contact should be flush with cable dielectric end.

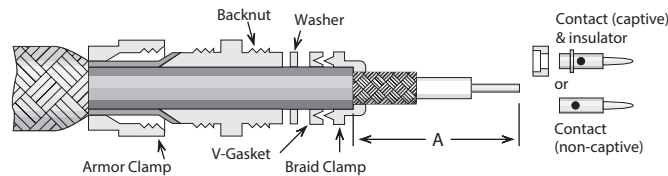


- 4) Insert prepared cable and hardware into body and tighten backnut. For right angle connectors with access cap, solder cable center conductor to slot in contact and tighten access cap.

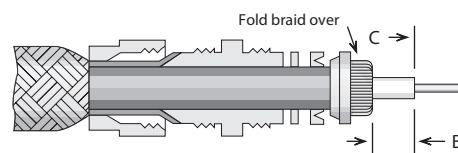
Trim Codes

Code	A	B	C
C/01	.656 (21/32)	.141 (9/64)	.250 (1/4)
C/02	.500 (1/2)	.125 (1/8)	.250 (1/4)
C/03	.450	.136	.187
C/04	.375 (3/8)	.109 (7/64)	.125 (1/8)
C/05	.375 (3/8)	.062 (1/16)	.250 (1/4)
C/06	.500 (1/2)	.188 (3/16)	.125 (1/8)
C/07	.575	.438	.094
C/08	.625 (5/8)	.141 (9/64)	.219 (7/32)

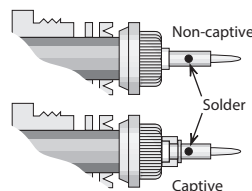
## Assembly Procedure D



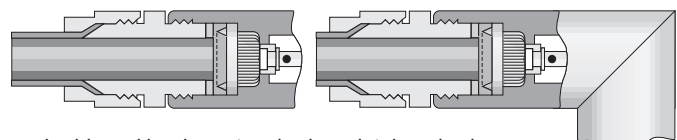
- 1) Slide armor clamp over cable. Push armor back to expose cable end. Slide backnut, washer (if supplied), gasket, and braid clamp onto cable as shown. Cable jacket should bottom on step in braid clamp. Trim cable jacket to dimension A.



- 2) Comb braid wires out straight and fold back over front shoulder of braid clamp (braid wires should not overlap one another after folding). Trim braid wires flush with edge of braid clamp. Trim cable dielectric and center conductor to dimensions B and C.



- 3) Assemble rear insulator (if captive contact) and contact, and solder contact to center conductor. Rear of contact should be flush with cable dielectric end.

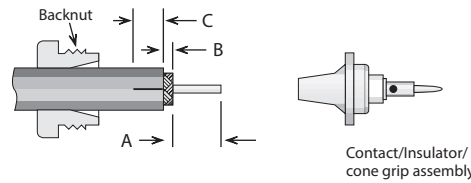


- 4) Insert prepared cable and hardware into body and tighten backnut. Trim armor to fit between armor clamp and braid clamp. Tighten armor clamp.

Trim Codes

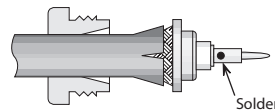
Code	A	B	C
D/01	.375 (3/8)	.047 (3/64)	.250 (1/4)
D/02	.500 (1/2)	.188 (3/16)	.219 (7/32)
D/03	.344 (11/32)	.047 (3/64)	.219 (7/32)
D/04	.313 (5/16)	.047 (3/64)	.172 (11/64)
D/05	.625 (5/8)	.281 (9/32)	.250 (1/4)
D/06	.313 (5/16)	.062 (1/16)	.109 (7/64)

## Assembly Procedure E

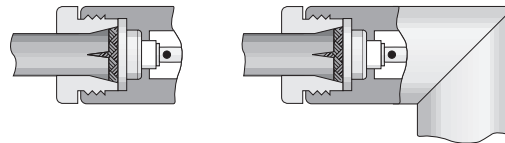


- 1) Slide backnut onto cable as shown. Trim cable to dimensions A and B as shown. Slit jacket to dimension C in two places, 180° apart.

Trim Codes			
Code	A	B	C
E/01	.250 (1/4)	.141 (9/64)	.313 (5/16)
E/02	.219 (7/32)	.063 (1/16)	.250 (1/4)
E/03	.250 (1/4)	.031 (1/32)	.250 (1/4)



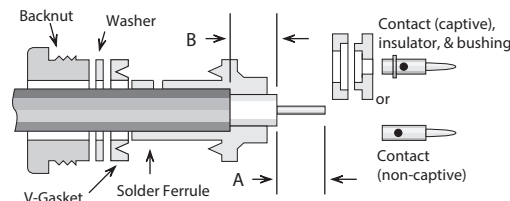
- 2) Slide cone/insulator/contact assembly under braid until braid is flush with shoulder. Solder contact to center conductor.



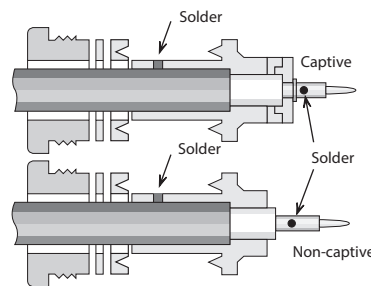
- 3) Insert prepared cable and hardware into body; tighten assembly by holding grip stationary and turning body.

## Assembly Procedure F

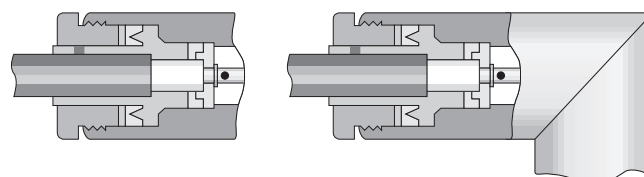
Trim Codes		
Code	A	B
F/01	.250 (1/4)	.219 (7/32)
F/02	.250 (1/4)	.172 (11/64)
F/03	.188 (3/16)	.188 (3/16)
F/04	.109 (7/64)	.265 (17/64)
F/05	.156 (5/32)	.250 (1/4)
F/06	.219 (7/32)	.250 (1/4)
F/07	.156 (5/32)	.172 (11/64)
F/08	.109 (7/64)	.219 (7/32)



- 1) Trim cable per chart. Slide backnut, washer, v-gasket, and solder ferrule onto cable. Trimmed end of cable jacket should bottom on step in solder ferrule.

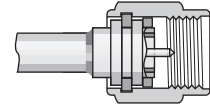
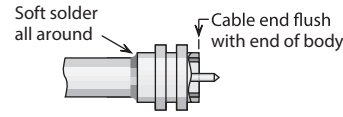
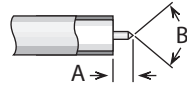
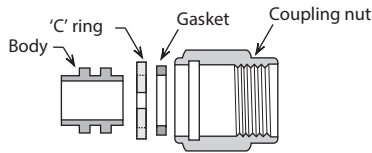


- 2) Solder ferrule to cable jacket as shown. Retrim cable dielectric to proper length if it has extruded from soldering heat. Slide bushing and rear insulator over cable dielectric if captive contact. Solder contact onto center conductor; back of contact flush with trimmed end of cable dielectric.



- 3) Insert prepared cable and hardware into body and tighten backnut.

## Assembly Procedure G



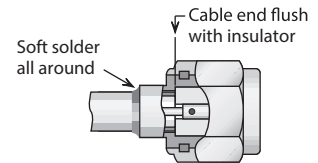
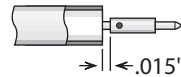
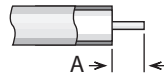
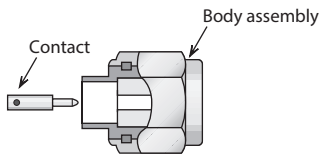
Trim Codes		
Code	A	B
G/01	.090	70-90°

1) Trim cable as shown. Remove any burrs from jacket and center conductor.

2) Soft solder cable jacket to body, making sure that end of cable is flush with end of body. After solder joint has cooled, retrim any protruding dielectric flush with end of body.

3) Assemble 'C' ring and gasket to body. Compress 'C' ring and slide body assembly into coupling nut until ring is seated in groove.

## Assembly Procedure H



Trim Codes	
Code	A
H/01	.090
H/02	.060
H/03	.115
H/04	.150

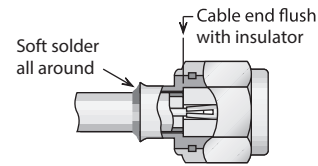
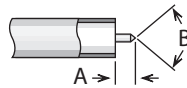
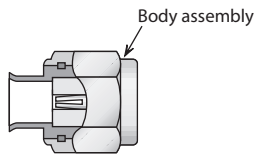
1) Trim cable as shown. Remove any burrs from jacket and center conductor.

2) Solder contact to center conductor, fixturing to maintain gap as shown. Remove any excess solder from outside of contact.

3) Insert cable into body and solder cable jacket to body, keeping end of cable flush with insulator as shown.

Plug body assembly and contact shown; procedure is identical for jack connectors.

## Assembly Procedure I



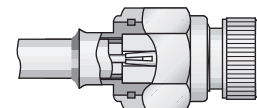
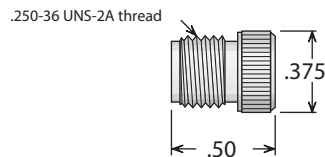
Trim Codes		
Code	A	B
I/01	.090	70-90°

1) Trim cable as shown. Remove any burrs from jacket and center conductor.

2) Insert cable into body and solder cable jacket to body, keeping end of cable flush with insulator as shown.

Plug body assembly and contact shown; procedure is identical for jack connectors.

### Cable Positioner



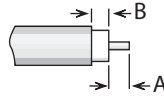
For .085" Cable:  
P/N 63-10072-2

For .141" Cable:  
P/N 63-10072-1

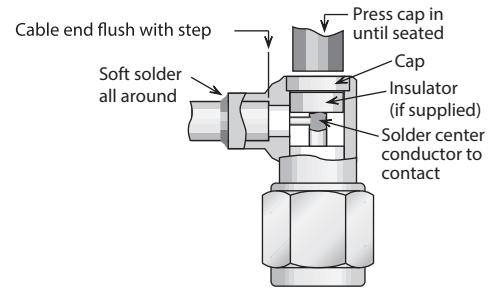
Using this positioner in the final step of assembly procedure H or I (for plugs only) will ensure that the contact and insulator are retained in the proper position to meet MIL-C-39012 requirements. The positioner should be screwed finger-tight into the mating end of the connector (as shown at right) before the cable jacket is soldered to the body assembly.

## Assembly Procedure J

Trim Codes		
Code	A	B
J/01	.109	.047
J/02	.059	.039
J/03	.059	.079
J/04	.050	.059

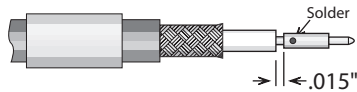
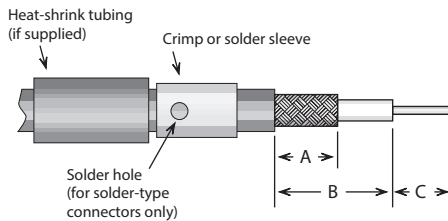


1) Trim cable as shown. Remove any burrs from jacket and center conductor.



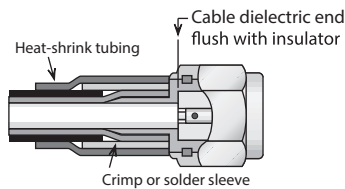
2) Soft solder cable jacket to body, making sure that end of cable is flush with step in body. Solder center conductor into contact slot, assemble insulator disc (if supplied), then press cap into body until seated or screw into place.

## Assembly Procedure K



1) Trim cable per chart. Slide crimp (or solder) sleeve and heat-shrink tubing (if supplied) back onto cable.

2) Solder contact onto center conductor, fixturing to maintain gap as shown. Flare cut end of braid slightly by rotating dielectric.



3) Insert cable/contact into rear of body, with all braid wires on outside of crimp tail. Push cable in until cable dielectric bottoms in connector. Trim excess braid wires even with shoulder of body. Slide crimp sleeve forward until flush with body and crimp (see page 211 for hex die sizes). (For solder-type connectors, solder braid to body and sleeve through hole in sleeve.) Slide heat-shrink tubing into place and shrink with hot-air gun.

Plug body assembly and contact shown; procedure is identical for jack connectors.

Trim Codes							
Code	A	B	C	Code	A	B	C
K/01	.250	.270	.110	K/07	.220	.290	.135
K/02	.200	.270	.140	K/08	.420	.620	.090
K/03	.225	.290	.110	K/09	.090	.135	.160
K/04	.225	.330	.110	K/10	.250	.415	.115
K/05	.250	.330	.110	K/11	.250	.400	.150
K/06	.250	.315	.095	K/12	.282	.390	.140