

JOHNSON™

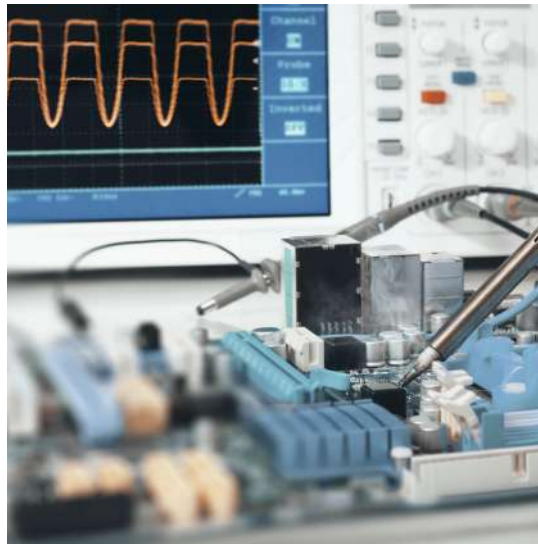

High Speed Miniature Product Catalog

SMP3, SMPM and SMP

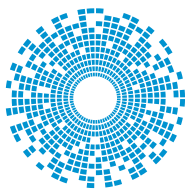

cinch
CONNECTIVITY SOLUTIONS
a bel group

belfuse.com/cinch

About Bel

Bel is a publicly traded company that has been operated by the same family for over 65 years. Our history of organic growth and acquisitions have broadened our product portfolio. This has established Bel as a world leader with a diverse offering of power, protection and interconnect products. We design and manufacture these products which are primarily used in the networking, telecommunications, computing, military, aerospace, transportation and broadcasting industries. Bel's portfolio of products also finds application in the automotive, medical and consumer electronics markets.

About Johnson™

Johnson designs and manufactures an industry-leading line of RF coaxial connectors and adapters, available in both 50 and 75 Ohm versions, operating up to 67GHz. The range of products available within the product line includes board and cable mount connectors across subminiature, micro-miniature, ultra-miniature and millimeter wave classes as well as semi-rigid, conformable, and flexible RF coaxial cables. Johnson connectors are designed to provide the highest quality data transmission for data, audio, and video applications.

Table of Contents

SMP3

Introduction	3
Specifications	3
Surface Mount Connectors	4
Bullet Adapter	4
SMP3 -1.85mm Between Series Adapters	5
SMP3 - 2.4mm Between Series Adapters	6
SMP3 - 2.92mm Between Series Adapters	7

SMPM

Introduction	8
Specifications	9
PCB Mount Connectors	11
End Launch Connectors	12
Vertical Launch Connectors (Microstrip and Stripline)	12
Flange Mount Connectors	13
0.047" Cable Connectors	13
0.086" Cable Connectors	14
Ganged Edge Mount Connectors	15
Blind Mate Interconnect	15
Between Series Adapters	17
Tools	18

SMP

Introduction	19
Specifications	20
PCB Mount Connectors	24
End Launch Connectors	25
Vertical Launch Connectors (Microstrip and Stripline)	25
Flange Mount Connectors	26
Hermetic Seal	27
0.047" Cable Connectors	27
0.086" Cable Connectors	27
Ganged Connectors	28
Ganged Edge Mount Connectors	30
Blind Mate Interconnect	33
Same Series Adapters	33
Between Series Adapters	34
Tools	34
Assembly Instructions	35
Competitor Cross Reference	36

Introduction

Cinch Connectivity Solutions introduces the new SMP3 family of connectors. SMP3 is the next generation of sub-miniature push-on style connectors. It follows the prior generation SMPM and SMP connectors. SMP3 is more miniaturized (approximately 30% smaller than SMPM) and operates to 67 GHz by design. It is ideal for applications where there is high shock and vibration. The design is similar to SMPM and SMP for its utilization of a floating bullet. This helps compensate for axial and radial misalignment when mating. This also helps maintain a high performance retention in rugged military applications.

The sub-miniature, push-on connector interface is known for its blind mate capability. The smaller profile allows design engineers to fit the interconnects into dense packaging area.

Specifications

Environmental Specification

Meets or exceeds the applicable paragraph of MIL-PRF-39012

Operating temperature	-65°C to +165°C
Thermal shock	MIL-STD-202, Method 107, Condition B
Corrosion/Salt Spray	MIL-STD-202, Method 101, Condition B
Vibration	MIL-STD-202, Method 204, Condition D
Mechanical Shock	MIL-STD-202, Method 213, Condition I
Moisture resistance	MIL-STD-202, Method 106 (except step 7b omitted)

Mechanical Specification

Interface Design: MIL-STD-348A, Series SMP3

Engagement Force (pounds maximum, mated pair)	Full detent (FD)	2.5
Disengagement Force (pounds minimum, mated pair)	Full detent (FD)	4.5
Mated Radial Misalignment	Between centerlines of mating planes	0.010"
Mated Axial Misalignment	Between mating planes	
Durability (mating cycles minimum)	Full detent (all connectors and adapters)	100

Mounting Holes

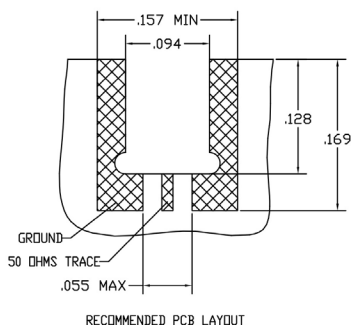

Figure 1

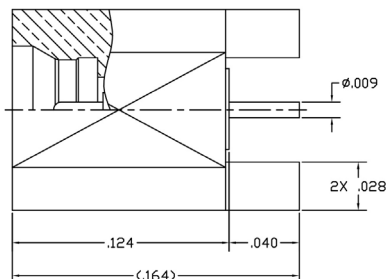

Figure 2

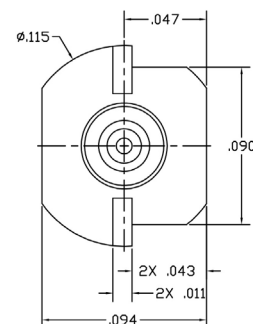
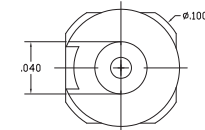
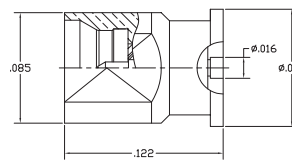
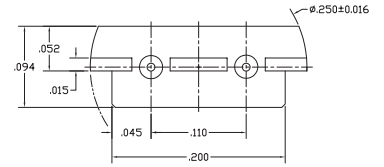
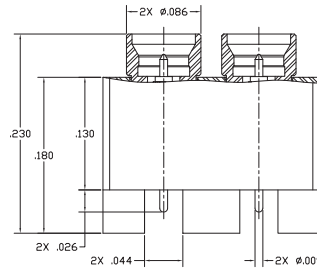
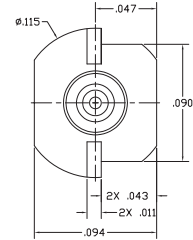
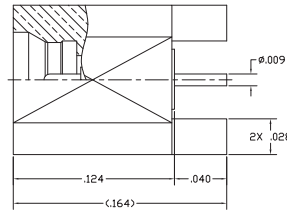

Figure 3

Surface Mount Connectors

Part Number	Description	Interface	Interface	VSWR	Frequency Range
123-0701-801	End Launch Male	Full Detent	50 Ohms	1.5 Max	DC - 50 GHz
123-0701-811	End Launch Male 2 port	Full Detent	50 Ohms	1.5 Max	DC - 67 GHz
123-0701-201	Vertical Surface Mount	Full Detent	50 Ohms	1.4 Max	DC - 50 GHz



Bullet Adapter

Female to Female Bullet Adapter

Part Number	Material	Impedance	VSWR	Frequency Range
123-0901-801	Gold-Plated	50 Ohms	1.4 Max	DC - 67 GHz

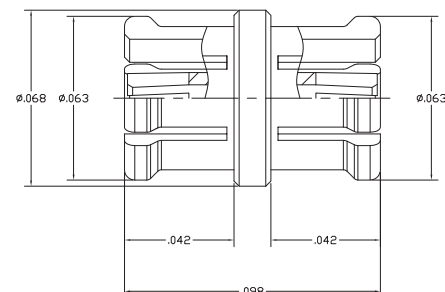

SMP3 -1.85mm Between Series Adapters

1.85mm Male to SMP3 Male

Part Number	Material	Impedance	VSWR	Frequency Range
134-1000-032	Passivated	50 Ohms	1.30 Max	DC - 67 GHz

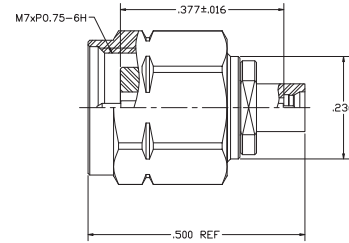

1.85mm Male to SMP3 Female

Part Number	Material	Impedance	VSWR	Frequency Range
134-1000-033	Gold-Plated	50 Ohms	1.30 Max	DC - 67 GHz

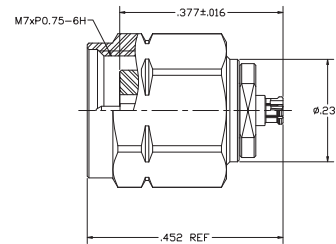

1.85mm Female to SMP3 Male

Part Number	Material	Impedance	VSWR	Frequency Range
134-1000-034	Passivated	50 Ohms	1.30 Max	DC - 67 GHz

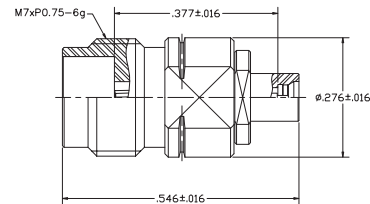

1.85mm Female to SMP3 Female

Part Number	Material	Impedance	VSWR	Frequency Range
134-1000-035	Gold-Plated	50 Ohms	1.30 Max	DC - 67 GHz

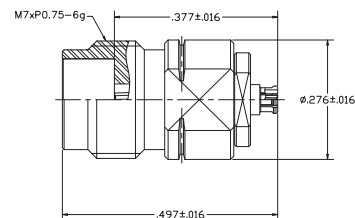

SMP3 - 2.4mm Between Series Adapters

2.4mm Male to SMP3 Male

Part Number	Material	Impedance	VSWR	Frequency Range
134-1000-036	Passivated	50 Ohms	1.25 Max	DC - 50 GHz

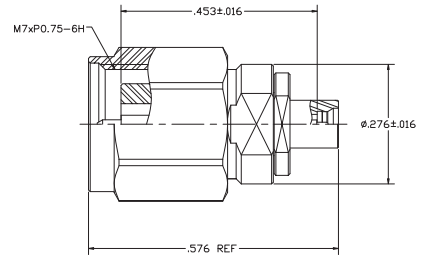

2.4mm Male to SMP3 Female

Part Number	Material	Impedance	VSWR	Frequency Range
134-1000-037	Gold-Plated	50 Ohms	1.25 Max	DC - 50 GHz

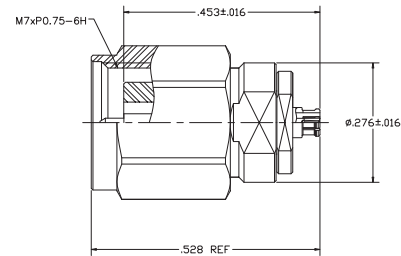

2.4mm Female to SMP3 Male

Part Number	Material	Impedance	VSWR	Frequency Range
134-1000-038	Passivated	50 Ohms	1.25 Max	DC - 50 GHz

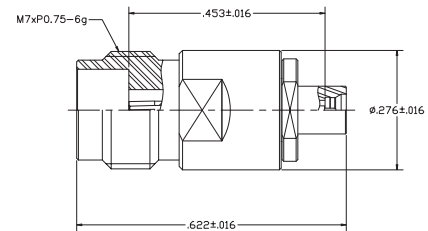

2.4mm Female to SMP3 Female

Part Number	Material	Impedance	VSWR	Frequency Range
134-1000-039	Gold-Plated	50 Ohms	1.25 Max	DC - 50 GHz

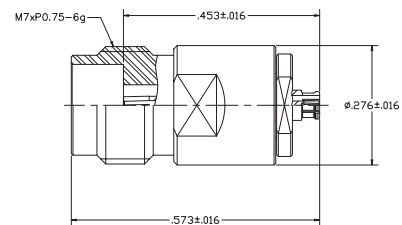

SMP3 - 2.92mm Between Series Adapters

2.92mm Male to SMP3 Male

Part Number	Material	Impedance	VSWR	Frequency Range
134-1000-040	Passivated	50 Ohms	1.25 Max	DC - 40 GHz

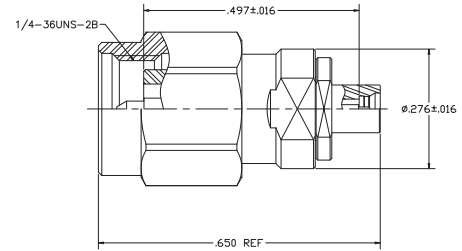

2.92mm Male to SMP3 Female

Part Number	Material	Impedance	VSWR	Frequency Range
134-1000-041	Gold-Plated	50 Ohms	1.25 Max	DC - 40 GHz

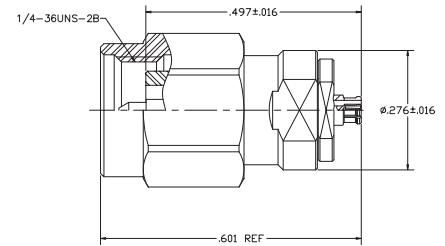

2.92mm Female to SMP3 Male

Part Number	Material	Impedance	VSWR	Frequency Range
134-1000-042	Passivated	50 Ohms	1.25 Max	DC - 40 GHz

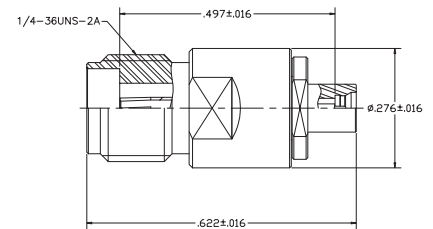

2.92mm Female to SMP3 Female

Part Number	Material	Impedance	VSWR	Frequency Range
134-1000-043	Gold-Plated	50 Ohms	1.25 Max	DC - 40 GHz

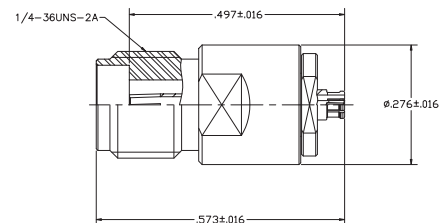

Introduction

Cinch Connectivity Solutions offers the Johnson line of SMPPM connectors. The sub-miniature, push-on style micro interfaces are distinguished for blind mating and for their size (about 35% smaller than the SMP design) and becoming increasingly popular for the two-fold design benefit of allowing for a higher-density of connection points and maintaining solid Return Loss performance from DC-level frequencies up to 65 GHz.

The Johnson SMPPM family includes PC mount, End Launch and Vertical Launch styles, and straight and right-angled, 0.047" and 0.086" cabled connectors and sealable flange mounts. All male connectors are offered in both full detent or smooth bore designs to meet your preference of engagement / disengagement forces. Detent features are provided to retain the push-on connectors in mated condition. Different levels of engage and disengage forces are accomplished by various Detent offerings in the shroud housing.

The SMPPM bullet adapter provides the same coveted blind mate functionality as the larger SMP size connectors, mitigating axial and radial misalignment with negligible change to VSWR and other signal losses. The SMPPM-series is perfect for use in test equipment, instrumentation, phased array radar and MIMO and active antenna applications.

Key Features & Benefits

- 35% smaller than SMP connectors
- DC-65GHz
- Bullet adapter provides blind mate capabilities
- Excellent electrical performance with axial and radial misalignment
- Available in PC mount, end launch and cabled styles

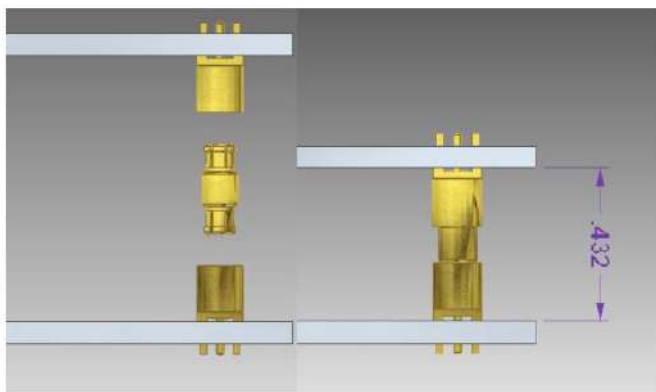

Estimated spacing between two mated boards connected via PC mount and bullet adapters

Specifications

The Johnson SMPM Connector Family provides an excellent solution for demanding applications requiring high frequency transmission.

- Precision manufacturing allows superior electrical performance of 1.15 to 18 GHz, 1.25 to 40 GHz and 1.45 to 65 GHz.
- Connector mating interface per MIL-STD-348A
- Mating interface control provides consistent electrical performance.
- Available in end launch, board mount, flange mount, vertical launch, cabled connector and bullet adapter/ between series adapter styles

Electrical Specification

Impedance	50 ohms			
Frequency Range:	Bullet adapter, semi-rigid straight cabled connectors	0-40 GHz		
	All other in-series adapters and connectors	0-18 GHz		
VSWR: (maximum)	Bullet adapter:	$\frac{0-18 \text{ GHz}}{1.15}$	$\frac{18-40 \text{ GHz}}{1.25}$	$\frac{40-65 \text{ GHz}}{1.45}$
	Connectors:	$\frac{0-20 \text{ GHz}}{1.20}$	$\frac{20-26.5 \text{ GHz}}{1.25}$	$\frac{26.5-40 \text{ GHz}}{1.30}$
Note: See drawing for additional specifications				
Insertion Loss: (dB maximum, tested at 10GHz)	Adapters and connectors	0.10 √ F (GHz)		
Working Voltage:	335 Vrms maximum at sea level, 65 Vrms maximum at 70,000 feet			
Dielectric Withstanding Voltage:	500 Vrms minimum at sea level			
RF High Potential Withstanding Voltage:	325 Vrms minimum at sea level, tested at 4 and 7MHz			
Corona Level:	190 Vrms minimum at 70,000 feet			
Contact Resistance: (milliohms maximum initial, not applicable after environmental testing)	Inner conductor	6.0		
	Outer conductor	2.0		
Insulation Resistance:	5000 megohms minimum			
RF Leakage:	Adapters and connectors	-80		

Mechanical Specification

Interface Design: MIL-STD-348A, Series SMPM

Engagement Force (pounds maximum, mated pair)	Full detent (FD)	15.0	
	Limited detent (LD)	10.0	
	Smooth bore and catcher's mitt (SB and CM)	2.0	
Disengagement Force (pounds minimum, mated pair)	Full detent (FD)	5.0	
	Limited detent (LD)	2.0	
	Smooth bore and catcher's mitt (SB and CM)	0.5	
Mated Radial Misalignment (inches maximum allowed)	Between centerlines of mating planes (FD,LD, SB)	0.010"	
	Between centerlines of mating planes (CM only)	0.020"	
Mated Axial Misalignment	010 inches maximum allowed between mating planes (female adapters only)		
Durability (mating cycles minimum)	Full detent (all connectors and adapters)	100	
	Limited detent	500	
	Smooth bore and catcher's mitt	1000	
Contact Retention	1.5 pounds minimum axial force (captivated contact)		
Cable Retention: (minimum)		Axial Force* (lbs)	Torque (in-oz)
	Cabled connectors for RG-405 (0.086 semi-rigid)	30	16.0
	Cabled connectors for M17/151 (0.047 semi-rigid)	20	N/A

*Or cable breaking strength, whichever is less

Environmental Specification

Meets or exceeds the applicable paragraph of MIL-PRF-39012

Operating temperature	-65°C to +165°C
Thermal shock	MIL-STD-202, Method 107, Condition B (except high temp +165°C or max high temp of cable)
Corrosion	MIL-STD-202, Method 101, Condition B
Vibration	MIL-STD-202, Method 204, Condition D
Shock (specified pulse)	MIL-STD-202, Method 213, Condition I
Moisture resistance	MIL-STD-202, Method 106 (except step 7b)

Mechanical Specification

Bodies: 348A, Series SMP	Beryllium copper per ASTM B196, gold* plated per MIL-DTL-45204 (0.00005" min)
Hermetic seal bodies (male)	Kovar alloy per ASTM F15, gold* plated per MIL-DTL-45204 (0.00005" min)
All other shroud bodies (male)	Stainless steel, type 303, per ASTM A582, passivated per MIL-DTL-14072 (EL 300)
Connector and adapter contacts (male and female)	Beryllium copper per ASTM B196, gold* plated per MIL-DTL-45204 (0.00005" min)
Hermetic seal center pins	Kovar alloy per ASTM F15, gold* plated per MIL-DTL-45204 (0.00005" min)
EML/anti-rock rings	Beryllium copper per ASTM B196, gold* plated per MIL-DTL-45204 (0.00003" min)
PC mount legs	Brass per ASTM B16, gold* plated per MIL-DTL-45204 (0.00003" min)
Connector and adapter insulators	Brass per ASTM B16, gold* plated per MIL-DTL-45204 (0.00003" min)
Hermetic seal glass	Corning 7070

*All gold plated parts include a 0.00005" minimum nickel barrier layer

PCB Mount Connectors

Straight PC mount, female

Part Number	Material	VSWR	Frequency Range
125-0801-201	Gold Plated	Dependent on application	0 - 40 GHz

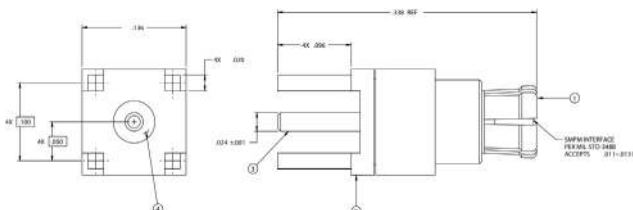

Straight PC mount male

Part Number	Material	Interface	VSWR	Frequency Range
125-0701-201	Gold Plated	Full Detent	Dependent on application	0 - 40 GHz
125-2701-201	Gold Plated	Smooth Bore	Dependent on application	0 - 40 GHz

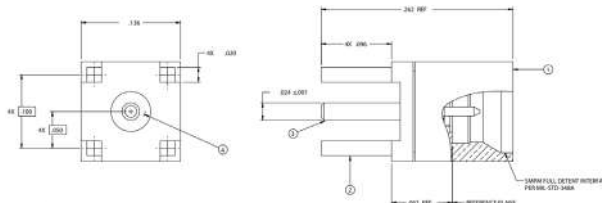

Straight PC Mount, male, 0.150" height (Low Profile)

Part Number	Material	Interface	VSWR	Frequency Range
125-0701-211	Gold Plated	Full Detent	Dependent on application	0 - 20 GHz

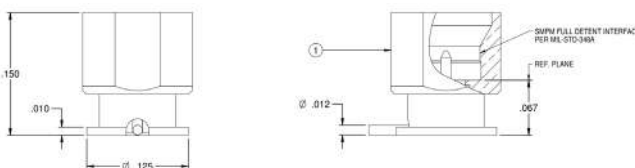

Straight PC Mount, male, 0.113" height (Super Low Profile)

Part Number	Material	Interface	VSWR	Frequency Range
125-0701-221	Gold Plated	Full Detent	Dependent on application	0 - 20 GHz

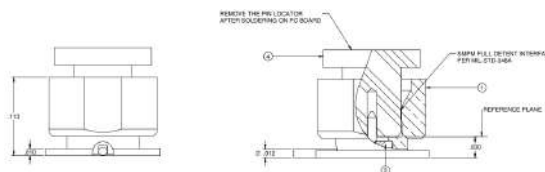

End Launch Connectors

End Launch Male

Part Number	Material	Interface	VSWR	Frequency Range
125-0701-801	Gold Plated	Full Detent	Dependent on application	0 - 40 GHz
125-2701-801	Gold Plated	Smooth Bore	Dependent on application	0 - 40 GHz

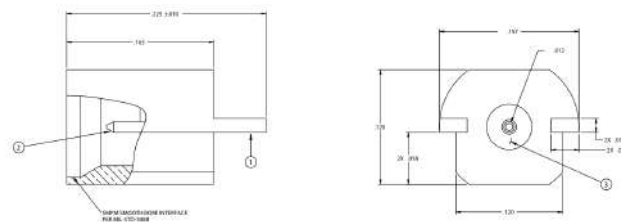

Vertical Launch Connectors

SMPM Compression Connector, Microstrip

Part Number	Material	Impedance	VSWR	Frequency Range
125-0701-241	Gold-Plated	50 Ohms	1.4 Typical from DC - 50 GHz	DC - 65 GHz

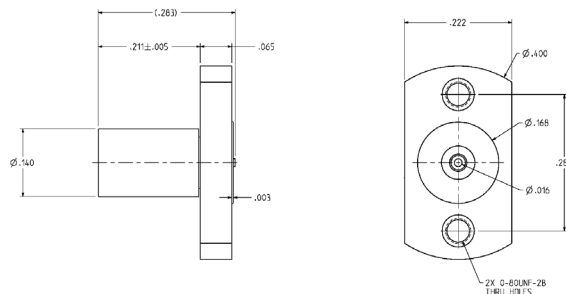

SMPM Compression Connector, Stripline

Part Number	Material	Impedance	Maximum Frequency	VSWR
125-0701-251	Gold-Plated	50 Ohms	DC - 65 GHz	1.4 Typical from DC - 50 GHz

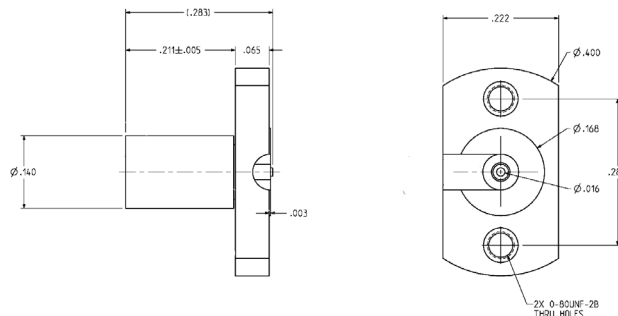

Flange Mount Connectors

2-hole flange mount male shroud, full detent

Part Number	Material	Interface	Frequency Range
125-0701-602	Gold Plated	Full Detent	DC - 40 GHz
125-2701-602	Gold Plated	Smooth Bore	DC - 40 GHz

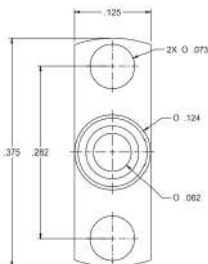

0.047" Cable Connectors

Straight male for 0.047" semi-rigid cable

Part Number	Material	Interface	VSWR	Frequency Range
125-0592-001	Gold Plated	Full Detent	1.15 Max to 26.5 GHz 1.30 Max to 40 GHz	DC - 40 GHz
125-2592-001	Gold Plated	Smooth Bore	1.15 Max to 26.5 GHz 1.30 Max to 40 GHz	DC - 40 GHz

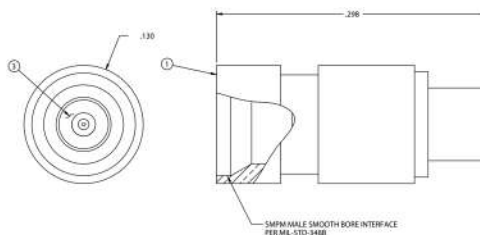

Straight female for 0.047" cable

Part Number	Material	VSWR	Frequency Range
125-0692-001	Gold Plated	1.15 to 26.5 GHz 1.30 to 40 GHz	DC - 40 GHz

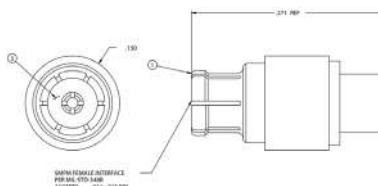

Low profile right-angled female for 0.047" cable, full detent

Part Number	Material	VSWR	Frequency Range
125-0692-111	Gold Plated	1.10 to 10 GHz 1.25 to 20 GHz	DC - 20 GHz

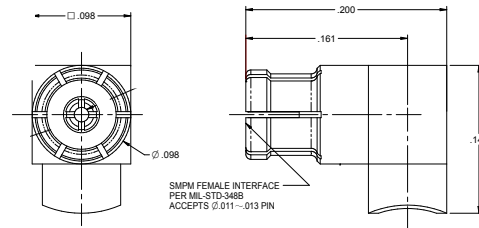

0.086" Cable Connectors

Straight male for 0.086" semi-rigid cable, full detent

Part Number	Material	VSWR	Frequency Range
125-0593-001	Gold Plated	1.15 Max 1.25 Max 1.45 Max	18 GHz 40 GHz 65 GHz

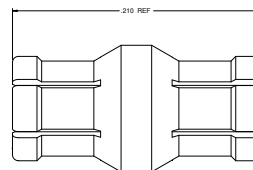

Right angle male for 0.086" semi-rigid cable, full detent

Part Number	Material	VSWR	Frequency Range
125-0593-101	Gold Plated	1.10 to 10 GHz 1.25 to 20 GHz	DC - 40 GHz

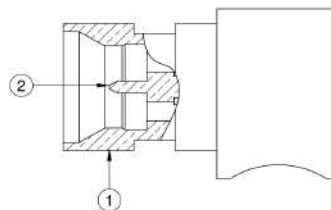

Ganged Edge Mount Connectors

Male, Full Detent, PCB Edge Mount

Part Number	No. of Ports	Interface	VSWR	Frequency Range
125-0701-821	2	Full Detent	1.15 Max	0 - 65 GHz

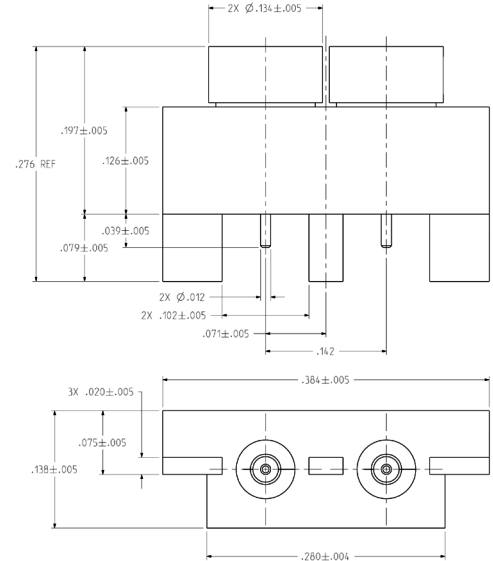
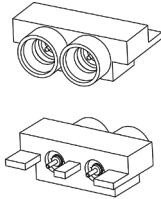

Male, Full Detent, PCB Edge Mount

Part Number	No. of Ports	Interface	VSWR	Frequency Range
125-0701-831	4	Full Detent	1.15 Max	0 - 65 GHz

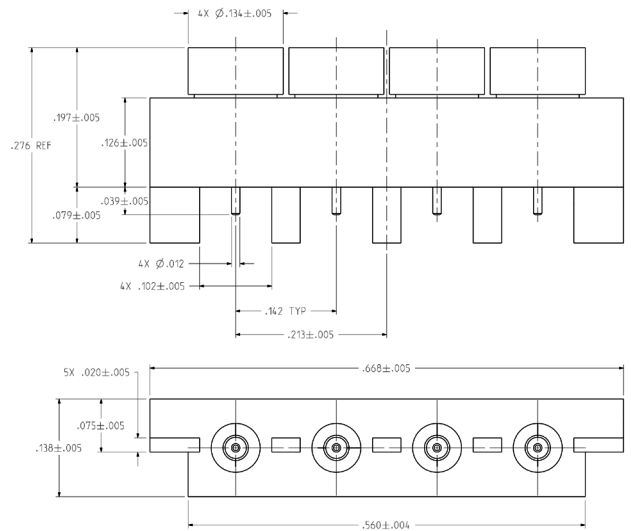
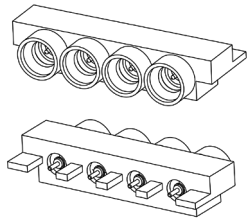

Male, Smooth Bore, PCB Edge Mount

Part Number	No. of Ports	Interface	VSWR	Frequency Range
125-2701-811	2	Smooth Bore	1.15 Max	0 - 65 GHz

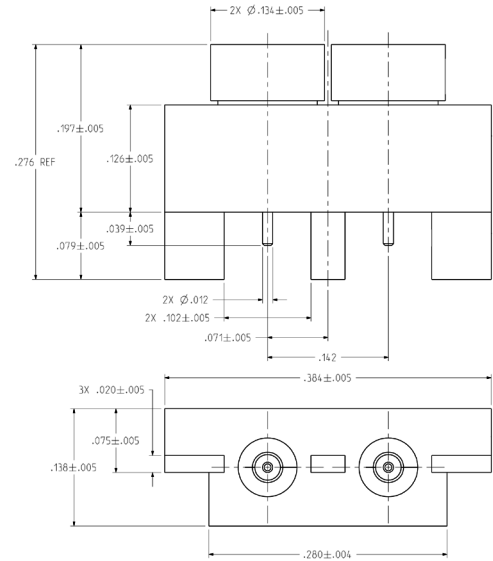
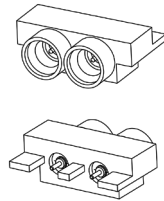

Male, Smooth Bore, PCB Edge Mount

Part Number	No. of Ports	Interface	VSWR	Frequency Range
125-2701-821	4	Smooth Bore	1.15 Max	0 - 65 GHz

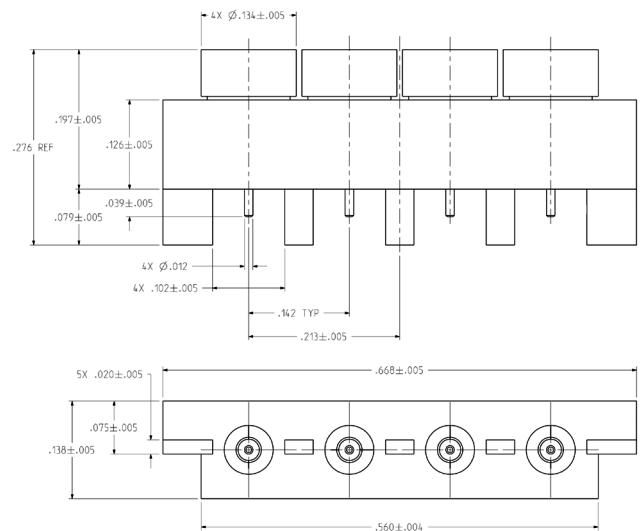
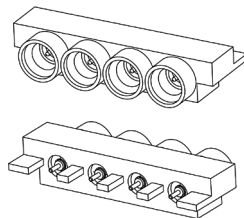

Blind Mate Interconnect

Bullet adapter, 0.210" Length

Part Number	Material	VSWR	Frequency Range
125-0901-811	Gold Plated	1.15 Max 1.25 Max 1.45 Max	DC – 18 GHz 18 – 40 GHz 40 – 65 GHz

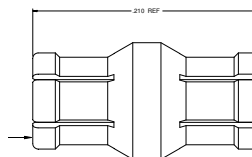

Bullet adapter, 0.265" Length

Part Number	Material	VSWR	Frequency Range
125-0901-801	Gold Plated	1.15 Max 1.25 Max 1.45 Max	DC – 18 GHz 18 – 40 GHz 40 – 65 GHz

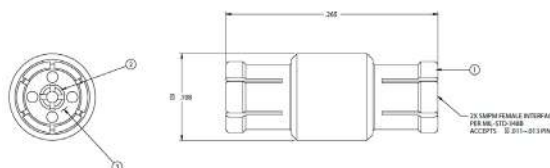

Between Series Adapters

SMA-SMPM Adapters

Part Number	Interface	VSWR	Frequency
134-1001-001	SMA Plug to SMPM Plug	1.20 Max 1.25 Max	DC - 20 GHz 20 - 26.5 GHz
134-1001-002	SMA Plug to SMPM Jack	1.20 Max 1.25 Max	DC - 20 GHz 20 - 26.5 GHz

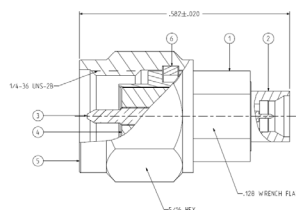

Part Number	Interface	VSWR	Frequency
134-1001-003	SMA Jack to SMPM Jack	1.20 Max 1.25 Max	DC - 20 GHz 20 - 26.5 GHz
134-1001-004	SMA Jack to SMPM Plug	1.20 Max 1.25 Max	DC - 20 GHz 20 - 26.5 GHz

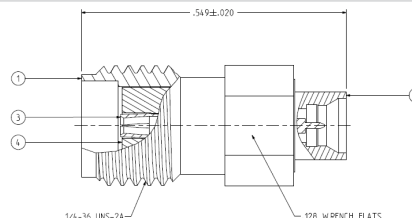

SMP-SMPPM Adapters

Part Number	Interface	VSWR	Frequency
134-1099-071	SMP Jack to SMPPM Plug	1.15 Max 1.25 Max 1.45 Max	DC - 18 GHz 18 - 26.5 GHz 26.5 - 40 GHz

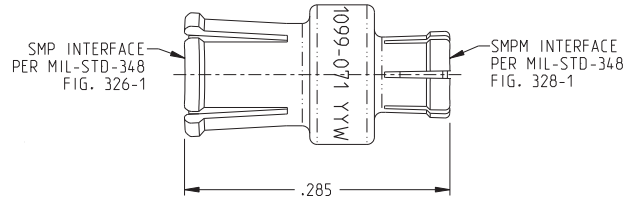

Tools

SMPPM extraction tool for cabled connectors

Part Number	Material
125-0000-900	Gold Plated



SMPPM bullet adapter installation/extraction tool

Part Number	Material
125-0000-901	Gold Plated

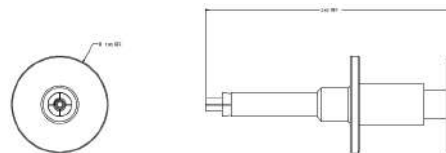

SMPPM bullet extraction removal tool

Part Number	Material
125-0000-906	Gold Plated

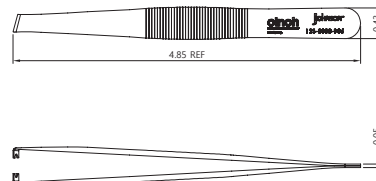

Introduction

Cinch Connectivity Solutions offers the Johnson line of industry standard SMP connectors. The sub-miniature, push-on connector interface is known for its micro miniature size and its blind mate capability. The smaller profile allows design engineers to fit the interconnects into dense packaging area. Blind mate means to accommodate for an up to 9 degree axial and radial misalignment with minimal impact on VSWR performance. This makes it ideal for application with shock and vibration. SMP has intermate compatibility with the Corning Gilbert GPO and other industry SMP connectors.

The SMP family offers connectors in various form factors including: End Launch, PC mount thru hole and surface mount, Vertical Launch (solderless compression mount), 2 hole flange, 4 hole flange, Ganged 2 port and 4 port in Vertical, Right Angle and Edge Launch, Straight and Right Angle cabled connectors for 0.086" and 0.047" cable types. The female-female bullet adapter is available in different lengths. Johnson offers shroud types: Full Detent, Limited Detent, Smooth Bore, and Catcher's Mitt. The family additionally provides between series adapters SMA-SMP, SMP-SMPM, 2.92mm-SMP, 2.4mm-SMP.

SMP connectors exhibit excellent return loss performance at frequencies from DC to 40 GHz. The design of the SMP bullet and shroud system allows for both axial and radial misalignment. The basic system is comprised of an inner "bullet" adapter, and two outer receptacles called "shrouds". The bullet provides a flexible link between the shroud connections. In blind-mate applications, one shroud connector will be typically specified as a snap-on interface and the other as a slide-on. This ensures that the bullet adapter remains fixed in the same shroud connector when the connection is disengaged.

The two snap-on interfaces Full Detent (FD) and Limited Detent (LD) each have different engage and disengage coupling forces. The LD is typically selected as the snap-on interface in PCB mount or blind-mate applications, while the FD is mainly used for cabled connections where higher retention forces are required. The two slide-on interfaces Smooth Bore (SB) and Catcher's Mitt (CM) allow for reduced connection forces as compared to the snap-on versions. The push-on interface creates a sliding connection that does not physically locate the mating reference planes, allowing for axial and radial misalignment. Both the SB and CM have the same engage/disengage forces; however the CM is typically specified as the shroud configuration in blind-mate applications as its generous lead-in chamfer helps capture and guide the bullet into place.

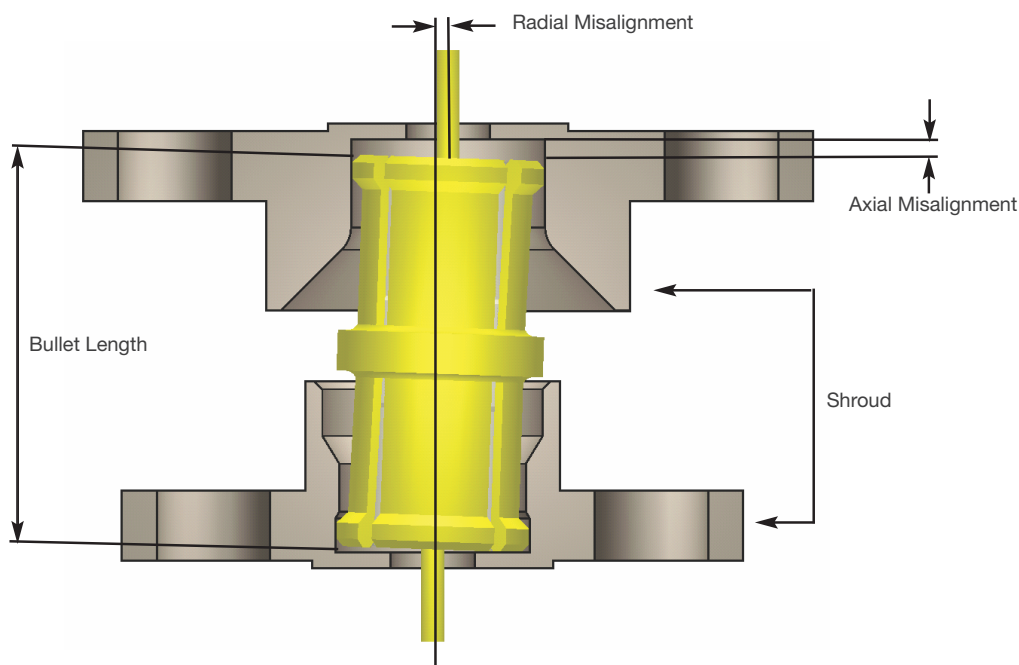

Specifications

The Johnson SMP Connector Family provides an excellent solution for demanding applications requiring high frequency transmission.

- Precision manufacturing allows superior electrical performance > 40 GHz with VSWR performance to < 1.70 Max
- Connector mating interface per MIL-STD-348A
- Mating interface control provides consistent electrical performance.
- Available in end launch, board mount, flange mount, vertical launch, cabled connector and bullet adapter/ between series adapter styles

Electrical Specification

Impedance	50 ohms		
Frequency Range:	Bullet adapter, semi-rigid straight cabled connectors	0-40 GHz	
	All other in-series adapters and connectors	0-18 GHz	
VSWR: (maximum)	Bullet adapter:	$\frac{0-18 \text{ GHz}}{1.10}$	$\frac{18-26.5 \text{ GHz}}{1.30}$
	Connectors:	$\frac{0-18 \text{ GHz}}{1.20}$	$\frac{18-26.5 \text{ GHz}}{1.35}$
		$\frac{26.5-40 \text{ GHz}}{1.70}$	$\frac{26.5-40 \text{ GHz}}{1.70}$
	Note: See drawing for additional specifications		
Insertion Loss: (dB maximum, tested at 10GHz)	Adapters and connectors	0.10 \sqrt{F} (GHz)	
Working Voltage:	335 Vrms maximum at sea level, 65 Vrms maximum at 70,000 feet		
Dielectric Withstanding Voltage:	500 Vrms minimum at sea level		
RF High Potential Withstanding Voltage:	325 Vrms minimum at sea level, tested at 4 and 7MHz		
Corona Level:	190 Vrms minimum at 70,000 feet		
Contact Resistance: (milliohms maximum initial, not applicable after environmental testing)	Inner conductor	6.0	
	Outer conductor	2.0	
Insulation Resistance:	5000 megohms minimum		
RF Leakage:	Adapters and connectors	-80	

Mechanical Specification

Interface Design: MIL-STD-348A, Series SMP

Engagement Force (pounds maximum, mated pair)	Full detent (FD)	15.0	
	Limited detent (LD)	10.0	
	Smooth bore and catcher's mitt (SB and CM)	2.0	
Disengagement Force (pounds minimum, mated pair)	Full detent (FD)	5.0	
	Limited detent (LD)	2.0	
	Smooth bore and catcher's mitt (SB and CM)	0.5	
Mated Radial Misalignment (inches maximum allowed)	Between centerlines of mating planes (FD,LD, SB)	0.010"	
	Between centerlines of mating planes (CM only)	0.020"	
Mated Axial Misalignment	010 inches maximum allowed between mating planes (female adapters only)		
Durability (mating cycles minimum)	Full detent (all connectors and adapters)	100	
	Limited detent	500	
	Smooth bore and catcher's mitt	1000	
Contact Retention	1.5 pounds minimum axial force (captivated contact)		
Cable Retention: (minimum)		Axial Force* (lbs)	Torque (in-oz)
	Cabled connectors for RG-405 (0.086 semi-rigid)	30	16.0
	Cabled connectors for M17/151 (0.047 semi-rigid)	20	N/A

*Or cable breaking strength, whichever is less

Typical Measured Return Loss Bullet Adapter 127-0901-801

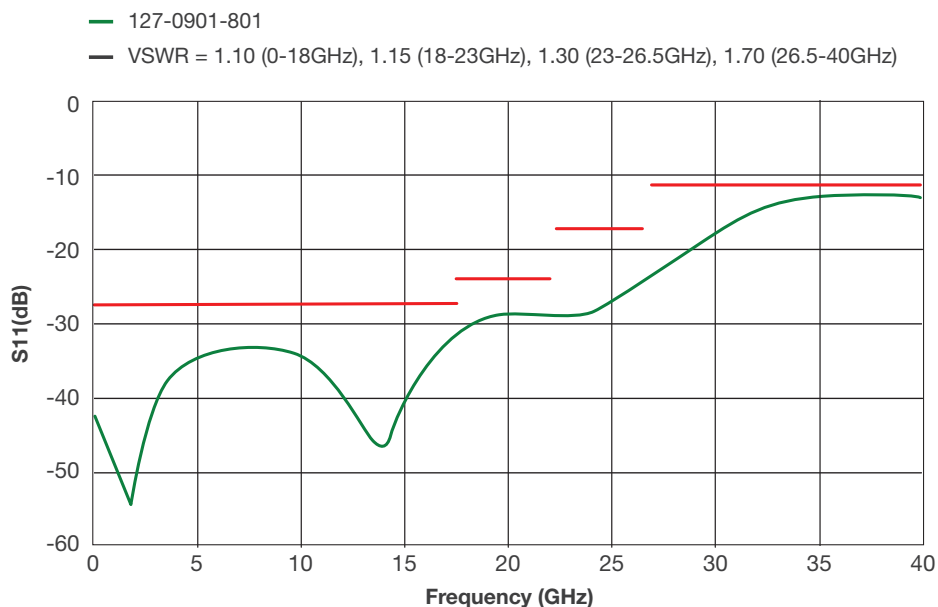

Environmental Specification

Meets or exceeds the applicable paragraph of MIL-PRF-39012

Operating temperature	-65°C to +165°C
Thermal shock	MIL-STD-202, Method 107, Condition B (except high temp +165°C or max high temp of cable)
Corrosion	MIL-STD-202, Method 101, Condition B
Vibration	MIL-STD-202, Method 204, Condition D
Shock (specified pulse)	MIL-STD-202, Method 213, Condition I
Moisture resistance	MIL-STD-202, Method 106 (except step 7b)

Mechanical Specification

Bodies: 348A, Series SMP	Beryllium copper per ASTM B196, gold* plated per MIL-DTL-45204 (0.00005" min)
Hermetic seal bodies (male)	Kovar alloy per ASTM F15, gold* plated per MIL-DTL-45204 (0.00005" min)
All other shroud bodies (male)	Stainless steel, type 303, per ASTM A582, passivated per MIL-DTL-14072 (EL 300)
Connector and adapter contacts (male and female)	Beryllium copper per ASTM B196, gold* plated per MIL-DTL-45204 (0.00005" min)
Hermetic seal center pins	Kovar alloy per ASTM F15, gold* plated per MIL-DTL-45204 (0.00005" min)
EMI/anti-rock rings	Beryllium copper per ASTM B196, gold* plated per MIL-DTL-45204 (0.00003" min)
PC mount legs	Brass per ASTM B16, gold* plated per MIL-DTL-45204 (0.00003" min)
Connector and adapter insulators	Brass per ASTM B16, gold* plated per MIL-DTL-45204 (0.00003" min)
Hermetic seal glass	Corning 7070

*All gold plated parts include a 0.00005" minimum nickel barrier layer

Mounting Holes

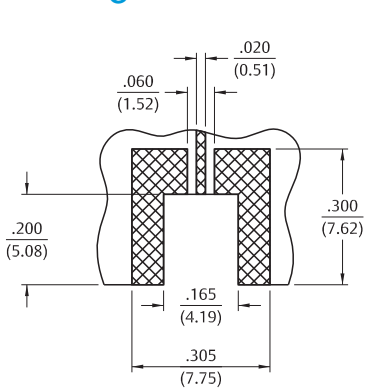

Figure 1

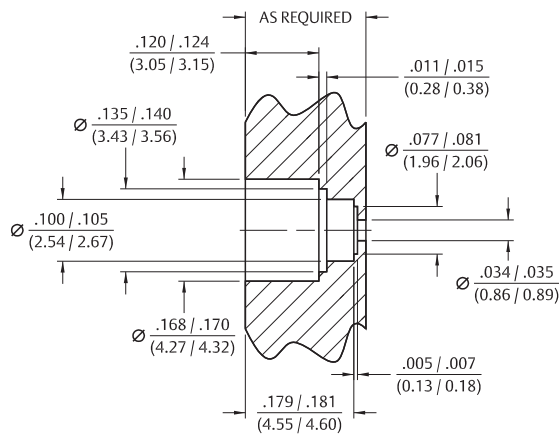

Figure 2

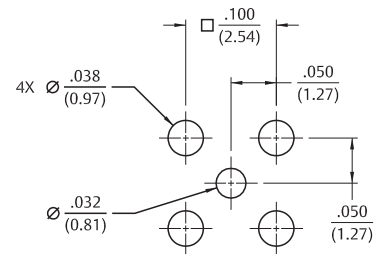
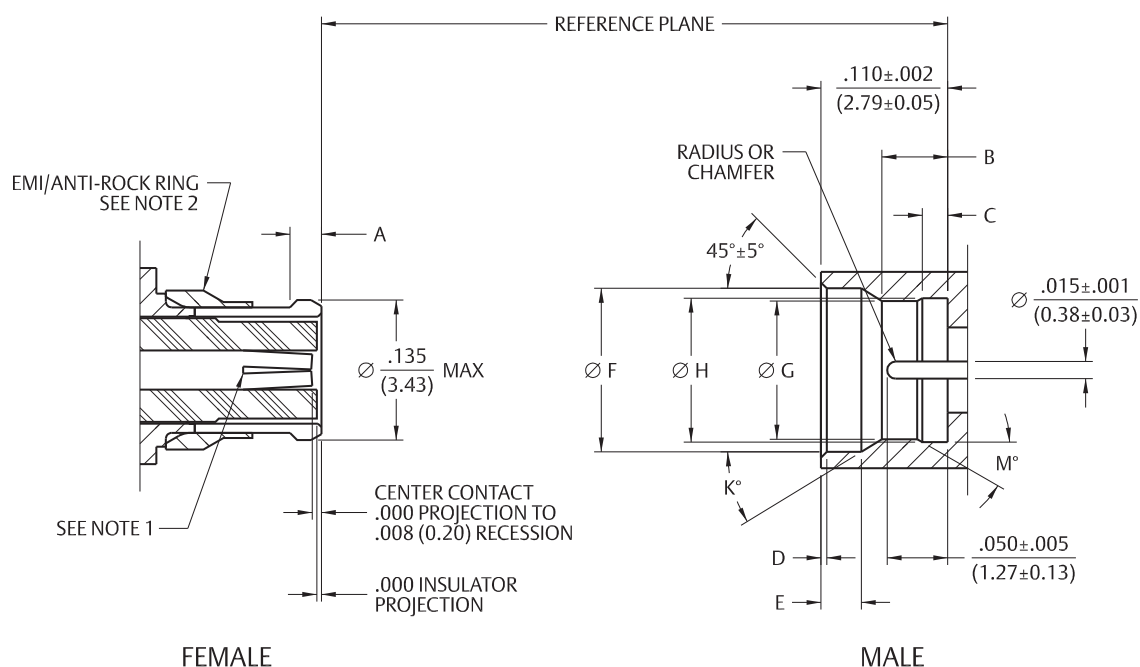

Figure 3

*This pattern is for reference only. Pattern will vary depending on board type and specific electrical and mechanical requirements.

Mating Engagement for SMP Series per MIL-STD-348A



Notes:

1. Socket to accept mating pin $\text{Ø}0.015\pm0.001$ (0.38±0.03).
2. EMI/Anti-Rock Ring configuration optional, used on cabled connectors only. Shall not prevent proper mating engagement.
3. All dimensions shown in inches. Metric equivalents (rounded to nearest 0.01mm) are given for general information only.

SMP Female Connector Interface

Dimension	Cabled		Uncabled	
	Minimum	Maximum	Minimum	Maximum
A	0.025 (0.64)	0.035 (0.89)	0.018 (0.46)	0.025 (0.64)

SMP Male Connector Interface

Dimension	Full Detent		Limited Detent		Smooth Bore		Catcher's Mitt	
	Minimum	Maximum	Minimum	Maximum	Minimum	Maximum	Minimum	Maximum
B	0.051 (1.30)	0.057 (1.45)	0.054 (1.37)	0.060 (1.52)	0.059 (1.50)	0.065 (1.65)	N/A	N/A
C	0.0205 (0.52)	0.0235 (0.60)	0.0205 (0.52)	0.0235 (0.60)	N/A	N/A	N/A	N/A
D	0.003 (0.08)	0.008 (0.20)	0.003 (0.08)	0.008 (0.20)	0.003 (0.08)	0.008 (0.20)	0.043 (1.09)	0.047 (1.19)
E	0.033 (0.84)	0.037 (0.94)	0.033 (0.84)	0.037 (0.94)	0.033 (0.84)	0.037 (0.94)	N/A	N/A
F	0.139 (3.53)	0.145 (3.68)	0.139 (3.53)	0.145 (3.68)	0.139 (3.53)	0.145 (3.68)	0.123 (3.12)	0.127 (3.23)
G	0.114 (2.90)	0.118 (3.00)	0.118 (3.00)	0.122 (3.10)	0.123 (3.12)	0.127 (3.23)	N/A	N/A
H	0.124 (3.15)	0.126 (3.20)	0.124 (3.15)	0.126 (3.20)	N/A	N/A	N/A	N/A
K	35° REF	35° REF	35° REF	35° REF	35° REF	35° REF	N/A	N/A
M	30° REF	30° REF	30° REF	30° REF	N/A	N/A	N/A	N/A

PCB Mount Connectors

Straight PCMount Male Receptacle

Part Number	Material	Interface	Frequency Range	"A"
127-0701-201	Passivated*	Full Detent	0-12GHz	0.218 (5.54)
127-1701-201	Passivated*	Limited Detent	0-12GHz	0.218 (5.54)
127-2701-201	Passivated*	Smooth Bore	0-12GHz	0.218 (5.54)
127-3701-201	Passivated*	Catcher's Mitt	0-12GHz	0.234 (5.94)

* Base and legs gold plated brass

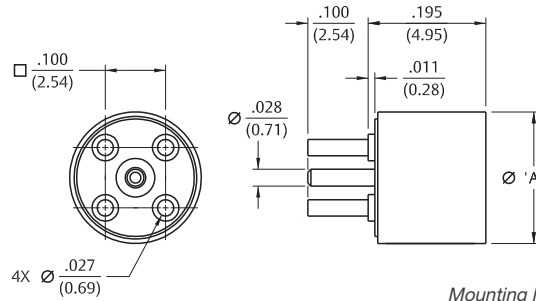

Mounting hole layout figure 3 on page 6

SMP Male, Straight Surface Mount

Part Number	Material	Interface	Impedance	VSWR	Maximum Frequency
127-0701-221	Gold-Plated	Full Detent	50 Ohms	1.5 Max	18 GHz
127-1701-221	Gold-Plated	Limited Detent	50 Ohms	1.5 Max	18 GHz
127-2701-221	Gold-Plated	Smooth Bore	50 Ohms	1.5 Max	18 GHz

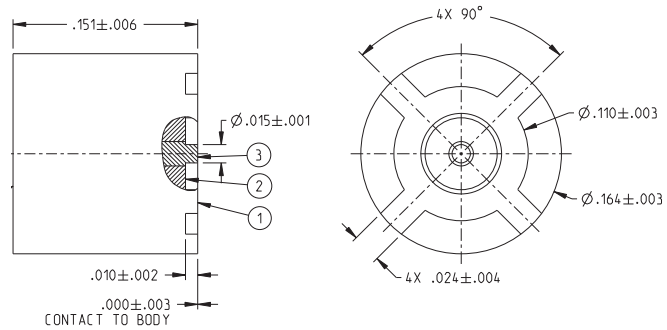

End Launch Connectors

End Launch Male Receptacle – Surface Mount

Part Number	Material	Interface	Frequency Range	Packaging
127-0701-801	Gold Plated	Full Detent	0-18GHz	Bag
127-0701-802	Gold Plated	Full Detent	0-18GHz	Tape and reel -1000 pieces
127-1701-801	Gold Plated	Limited Detent	0-18GHz	Bag
127-1701-802	Gold Plated	Limited Detent	0-18GHz	Tape and reel -1000 pieces
127-2701-801	Gold Plated	Smooth Bore	0-18GHz	Bag
127-2701-802	Gold Plated	Smooth Bore	0-18GHz	Tape and reel -1000 pieces

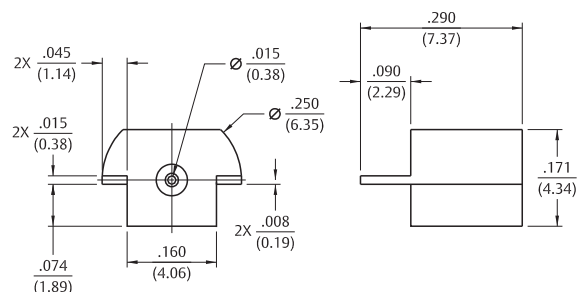
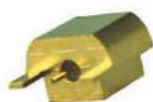

Vertical Launch Connectors

SMP Compression Connector, Microstrip

Part Number	Material	Impedance	VSWR	Maximum Frequency
127-0701-631	Gold-Plated	50 Ohms	1.5 Max	DC - 40 GHz

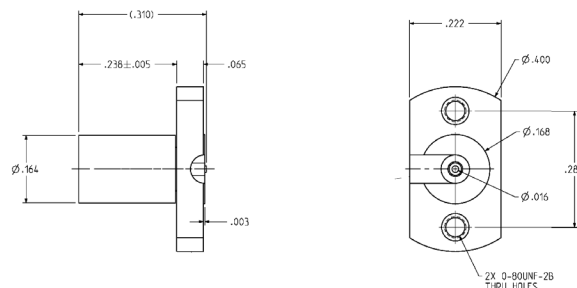

SMP Compression Connector, Stripline

Part Number	Material	Impedance	VSWR	Maximum Frequency
127-0701-641	Gold-Plated	50 Ohms	1.3 Max	DC - 40 GHz

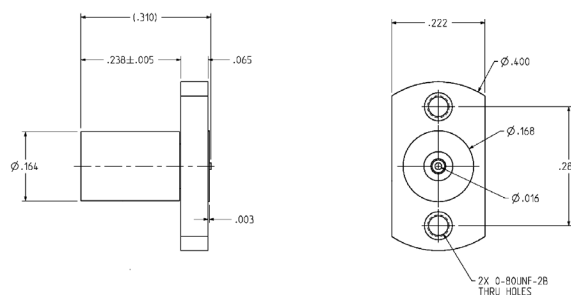

Flange Mount Connectors

2-Hole Flange Mount Male Shroud - Without Contact

Part Number	Material	Interface
127-0701-602	Passivated	Full Detent
127-1701-602	Passivated	Limited Detent
127-2701-602	Passivated	Smooth Bore

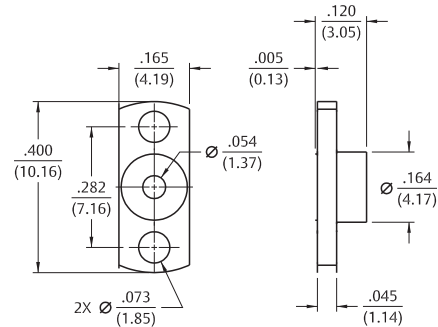

2-Hole Flange Mount Male Catcher's Mitt Shroud - Without Contact

Part Number	Material	Interface
127-3701-602	Passivated	Catcher's Mitt

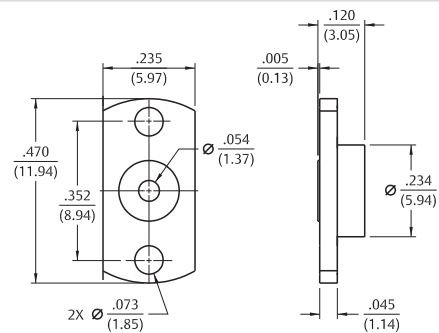

Mounting hole layout figure 1 on page 6

2-Hole Flange Mount Male Field Replaceable

Part Number	Material	Interface	VSWR	Frequency Range*	Accepts Pin Size
127-0701-612	Passivated	Full Detent	1.15 typical	0-18 GHz	0.012 (0.030)
127-1701-612	Passivated	Limited Detent	1.15 typical	0-18 GHz	0.012 (0.030)
127-2701-612	Passivated	Smooth Bore	1.15 typical	0-18 GHz	0.012 (0.030)

* Two connectors mated back to back with hermetic seal fixture

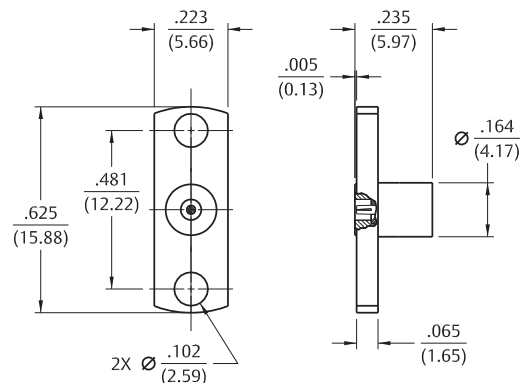

Hermetic Seal

Part Number	Material	Interface	Frequency Range
127-0701-601	Gold Plated	Full Detent	0-18 GHz
127-1701-601	Gold Plated	Limited Detent	0-18 GHz
127-2701-601	Gold Plated	Smooth Bore	0-18 GHz

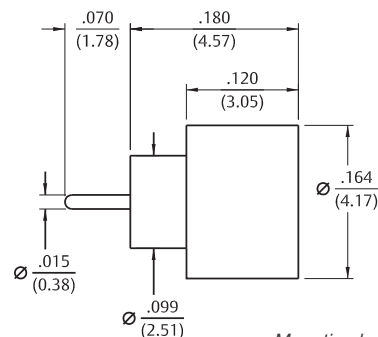

Mounting hole layout figure 2 on page 7

0.047" Cable Connectors

Part Number	Material	Cable Type	VSWR	Frequency Range*	Figure
127-0692-001	Gold Plated	M17/151, 0.047 Semi-Rigid Straight	1.20 max 1.35 max 1.70 max	0-18 GHz 18-26.5 GHz 26.5-40 GHz	1
127-0692-101	Gold Plated	M17/151, 0.047 Semi-Rigid Right Angle	1.20 max 0-18 GHz	127-0692-101	2

* Specifications dependent on cable ratings

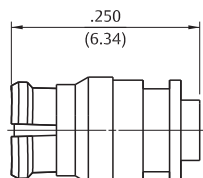

Figure 1
0.047"

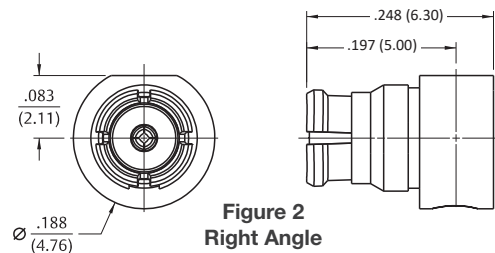

Figure 2
Right Angle

0.086" Cable Connectors

Part Number	Material	Cable Type	VSWR	Frequency Range*	Figure
127-0693-001	Gold Plated	RG-405, 0.086 Semi-Rigid Straight	1.20 max 1.35 max 1.70 max	0-18 GHz 18-26.5 GHz 26.5-40 GHz	3
127-0693-101		RG-405, 0.086 Semi-Rigid Right Angle	1.20 max 0-18GHz	127-0693-101	4

* Specifications dependent on cable ratings

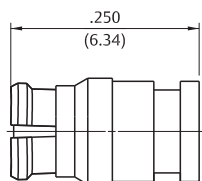

Figure 3
0.086"

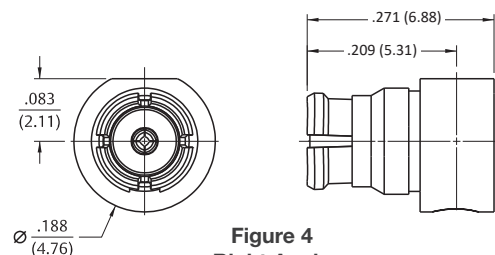
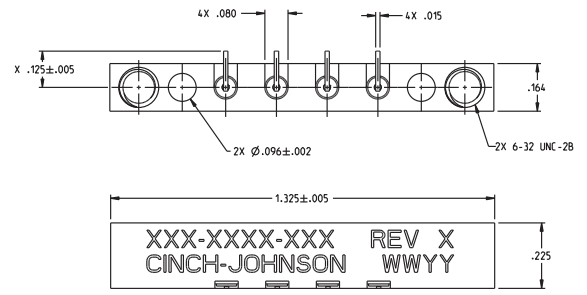
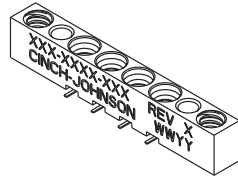

Figure 4
Right Angle

Ganged Connectors

Male, Full Detent, Vertical PCB Surface Mount

Part Number	No. of Ports	Interface	VSWR	Frequency Range
127-0711-221	4	Full Detent	1.25 Max 1.50 Max	0 - 18 GHz 18 - 26.5 GHz



Male, Full Detent, Right Angle PCB Surface Mount

Part Number	No. of Ports	Interface	VSWR	Frequency Range
127-0711-321	4	Full Detent	1.25 Max 1.50 Max	0 - 18 GHz 18 - 26.5 GHz

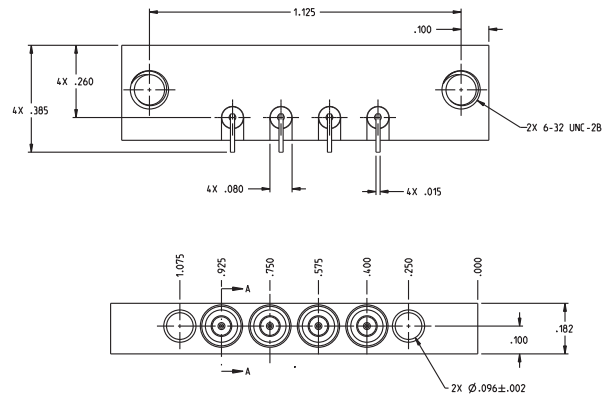
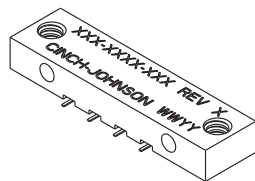

Male, Smooth Bore/Limited Detent, Vertical PCB Surface Mount

Part Number	No. of Ports	Interface	VSWR	Frequency Range
127-2711-221	4	Smooth Bore	1.25 Max 1.50 Max	0 - 18 GHz 18 - 26.5 GHz
127-1721-221	4	Limited Detent	1.25 Max 1.50 Max	0 - 18 GHz 18 - 26.5 GHz

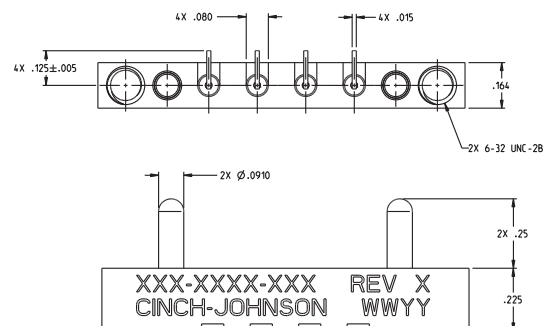
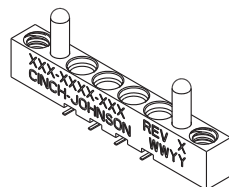

Male, Smooth Bore/Limited Detent Right Angle PCB Surface Mount

Part Number	No. of Ports	Interface	VSWR	Frequency Range
127-2711-321	4	Smooth Bore	1.25 Max 1.50 Max	0 - 18 GHz 18 - 26.5 GHz
127-1721-321	4	Limited Detent	1.25 Max 1.50 Max	0 - 18 GHz 18 - 26.5 GHz

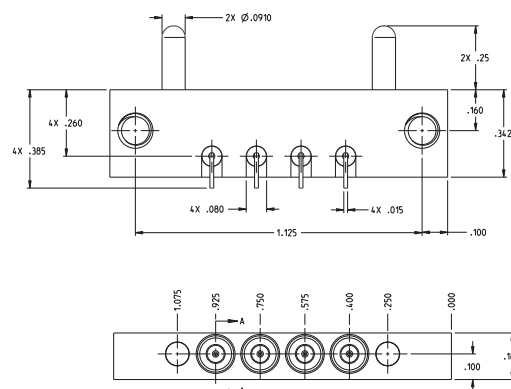
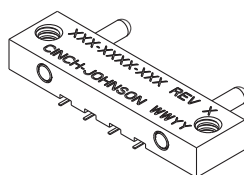

Male, Full Detent, Cabled

Part Number	No. of Ports	Interface	VSWR	Frequency Range
127-0593-011	4	Full Detent	1.25 Max 1.35 Max 1.50 Max	0 - 18 GHz 18 - 26.5 GHz 26.5 - 40 GHz

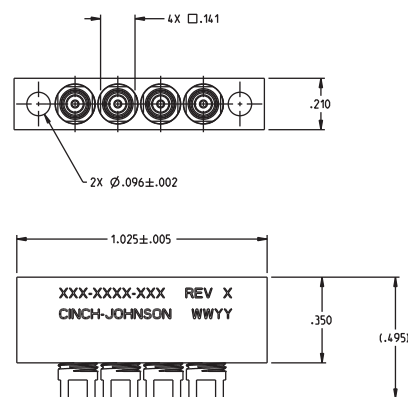
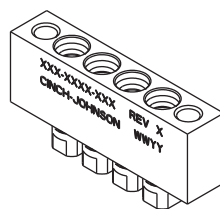

Ganged Edge Mount Connectors

Male, Full Detent, PCB Edge Mount

Part Number	No. of Ports	Interface	VSWR	Frequency Range
127-0701-811	4	Full Detent	1.5 Max	0 - 40 GHz

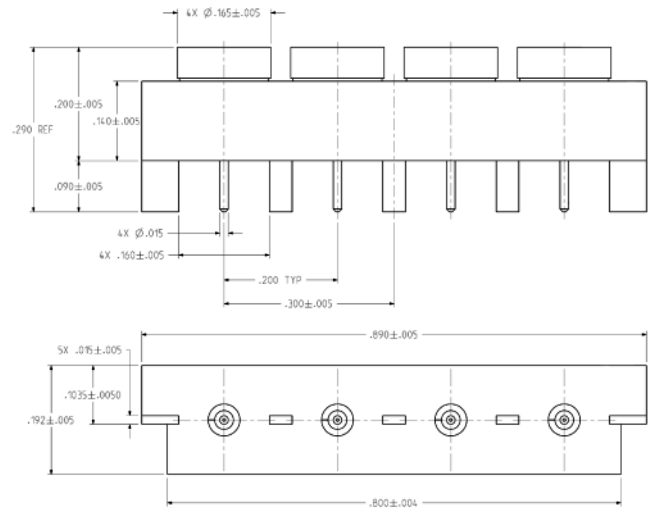
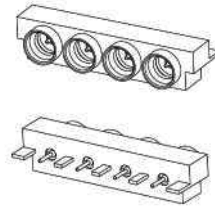

Male, Full Detent, PCB Edge Mount

Part Number	No. of Ports	Interface	VSWR	Frequency Range
127-0701-821	2	Full Detent	1.5 Max	0 - 40 GHz

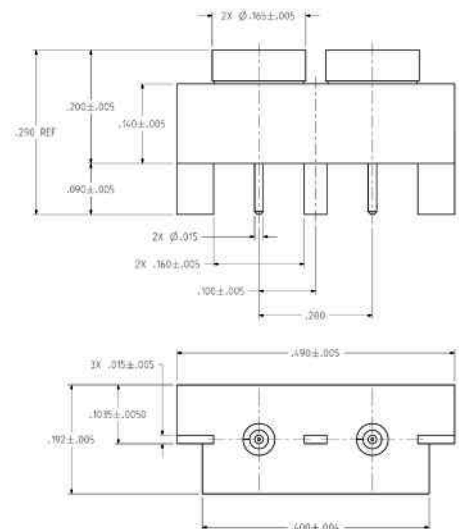
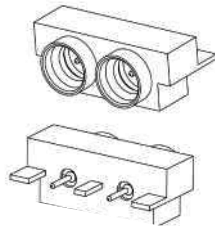

Male, Limited Detent, PCB Edge Mount

Part Number	No. of Ports	Interface	VSWR	Frequency Range
127-1701-821	2	Limited Detent	1.5 Max	0 - 40 GHz

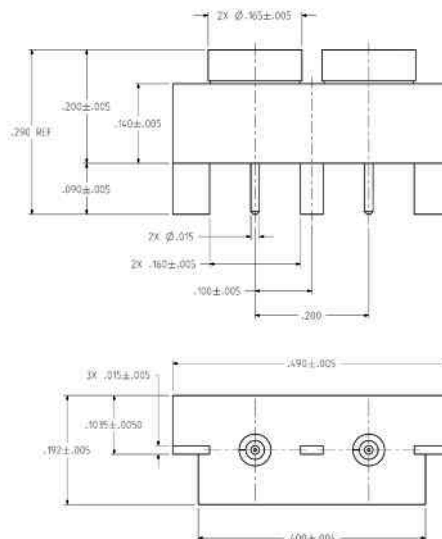
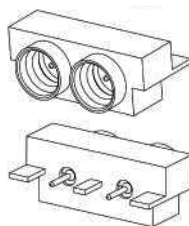

Male, Limited Detent, PCB Edge Mount

Part Number	No. of Ports	Interface	VSWR	Frequency Range
127-1701-831	4	Limited Detent	1.5 Max	0 - 40 GHz

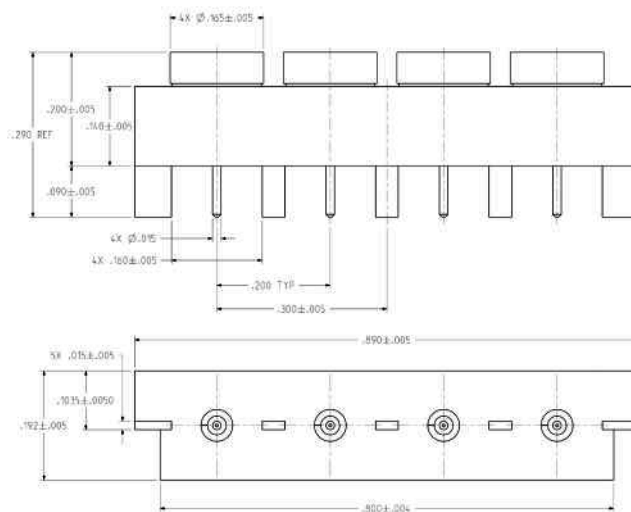
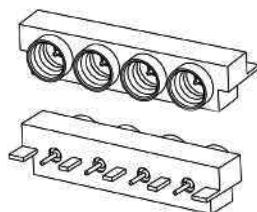

Male, Smooth Bore, PCB Edge Mount

Part Number	No. of Ports	Interface	VSWR	Frequency Range
127-2701-811	2	Smooth Bore	1.5 Max	0 - 40 GHz

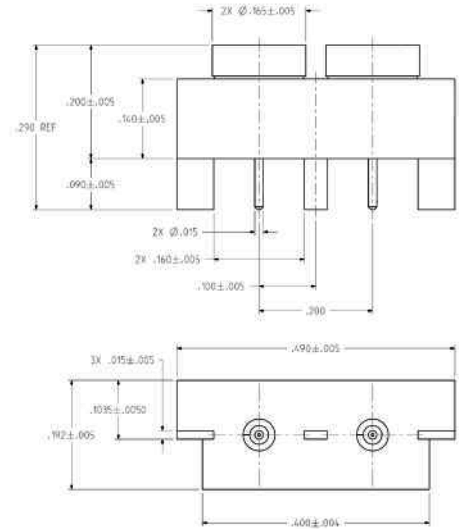
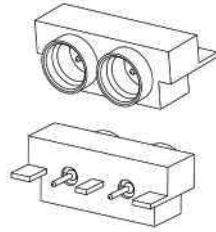

Male, Smooth Bore, PCB Edge Mount

Part Number	No. of Ports	Interface	VSWR	Frequency Range
127-2701-821	4	Smooth Bore	1.5 Max	0 - 40 GHz

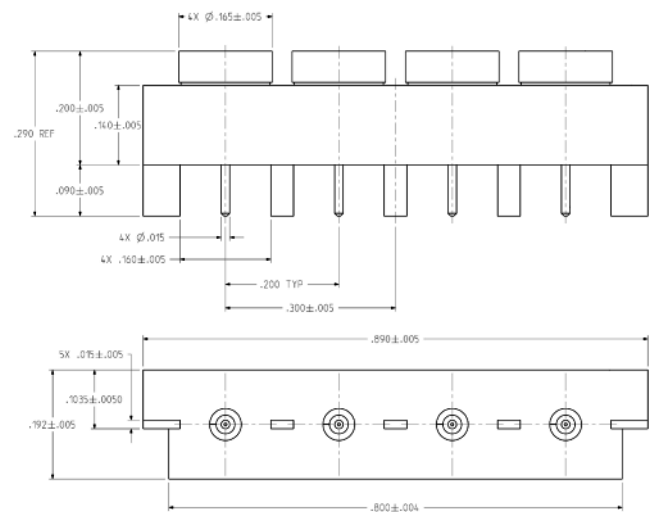
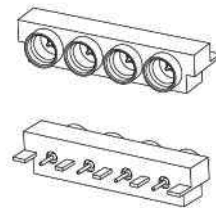

Blind Mate Interconnects

Female to Female Bullet Adapter

Part Number	Material	VSWR	Frequency Range
127-0901-801	Gold Plated	1.10 Max 1.15 Max 1.30 Max 1.70 Max	0-18 GHz 18-23 GHz 23-26.5 GHz 26.5-40 GHz

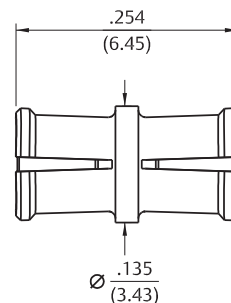

Female to Female Long Bullet Adapter

Part Number	Material	VSWR	Frequency Range
127-0901-811	127-0901-811	1.10 Max 1.15 Max 1.20 Max	0-4 GHz 4-12 GHz 12-18 GHz

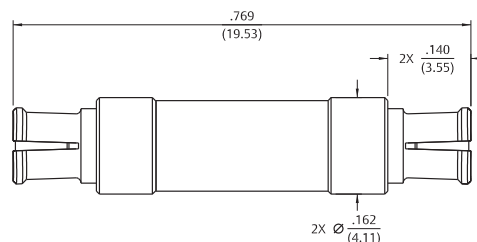

Same Series Adapters

Male to Male Catcher's Mitt Adapters, Stainless Steel

Part Number	Material	Interface	VSWR	Frequency Range
127-0901-822	Stainless Steel, Passivated	Full Detent	1.10 max 1.15 max 1.20 max	0-4 GHz, 4-12 GHz, 12-18 GHz
127-1901-822	Stainless Steel, Passivated	Limited Detent	1.10 max 1.15 max 1.20 max	0-4 GHz, 4-12 GHz, 12-18 GHz
127-2901-822	Stainless Steel, Passivated	Smooth Bore	1.10 max 1.15 max 1.20 max	0-4 GHz, 4-12 GHz, 12-18 GHz

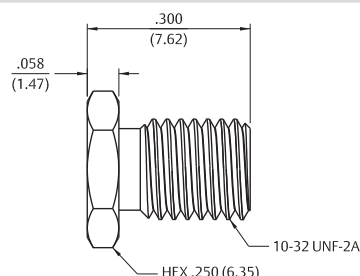

Between Series Adapters

SMA to SMP Adapters

Part Number	Material	Interface	VSWR	Frequency Range	Figure	Dimension A
134-1019-441	Gold Plated	SMA Plug to SMP Plug	1.20 max 1.25 max	0-20 GHz 20-26.5 GHz	1	.621 (15.77)
134-1019-451	Gold Plated	SMA Plug to SMP Jack	1.20 max 1.25 max	0-20 GHz 20-26.5 GHz	1	.561 (14.25)
134-1019-461	Gold Plated	SMA Jack to SMP Jack	1.20 max 1.25 max	0-20 GHz 20-26.5 GHz	2	.529 (13.44)
134-1019-471	Gold Plated	SMA Jack to SMP Plug	1.20 max 1.25 max	0-20 GHz 20-26.5 GHz	2	.574 (14.58)

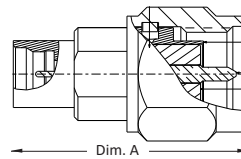

Figure 1

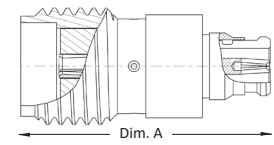
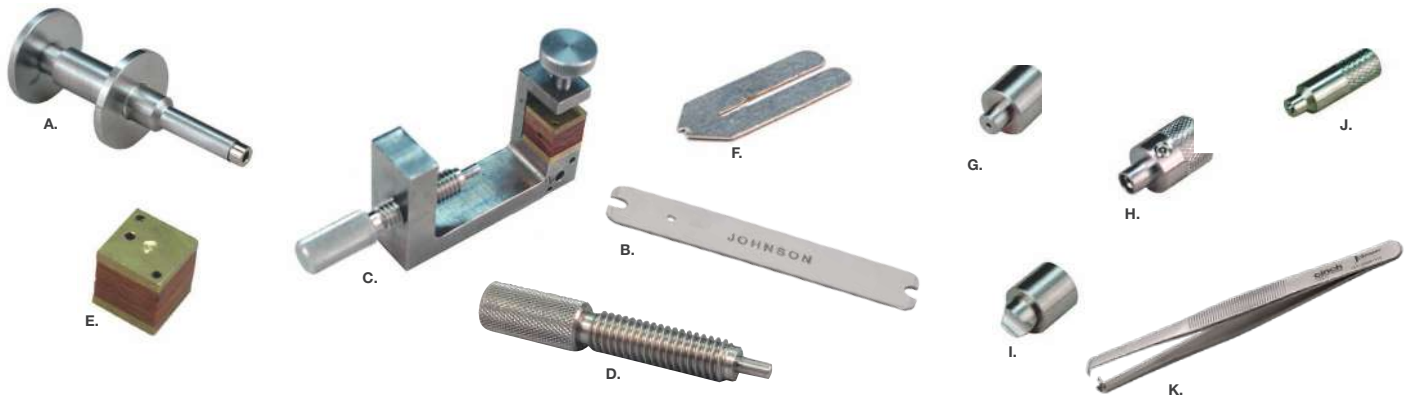

Figure 2

Tools

Accurate assembly of the semi-rigid cabled connectors is obtained with the tools listed below. Industry standard devices are used if possible for customer convenience and tool compatibility.



Part Number	Item	Description
127-0000-900	A	SMP bullet extraction tool
127-0000-901	B	SMP cabled connector removal tool
140-0000-962	C	Soldering vise (does not include clamp inserts or stop screw)
140-0000-981	D	Stop screw for soldering vise
140-0000-964	E	Semi-rigid cable clamp inserts for 0.086" OD cable
140-0000-997	E	Semi-rigid cable clamp inserts for 0.047" OD cable
140-0000-984	F	Solder shim for 0.086" OD cable
127-0000-902	G	SMP center contact holder
127-0000-903	H	SMP interface locator tool
127-0000-904	I	SMP right angle body holder
127-0000-905	J	SMP Full Detent shroud centering tool
127-0000-906	J	SMP Limited Detent shroud centering tool
127-0000-907	J	SMP Smooth Bore shroud centering tool
127-0000-910	K	SMP bullet extraction removal tool

Assembly Instructions

SMP Straight Female Solder Style for 0.047 OD Semi-Rigid Cable

1. Identify tools (5 piece parts) and connector parts (3 piece parts).
2. Strip cable jacket and dielectric to dimension shown. Do not nick center conductor. Clean all debris from prepared cable.
3. Insert center conductor into cable stop as shown and place contact onto center conductor.
4. Insert contact into contact holder fixture and clamp cable in vise. Tighten stop screw until light pressure is applied between contact, cable stop and cable jacket.
5. Solder contact to center conductor through solder hole using 0.016 (0.41) diameter flux core solder wire or solder paste. Use a minimum amount of solder and heat for a good joint. Do not allow heat to build up for a long period of time as cable stop may melt.
6. After solder joint has cooled, remove cable from vise. Remove any excess solder from contact with a sharp blade and clean all debris from contact and cable.
7. Insert contact into connector assembly, making sure cable stop bottoms out against internal shoulder of connector body. Insert connector assembly into interface location fixture and clamp cable in vise. Make sure connector assembly is fully engaged within location fixture. Tighten stop screw until light pressure is applied between connector assembly and cable stop.
8. Solder end of connector body to cable jacket, using a minimum amount of solder and heat for a full fillet joint. Allow assembly to cool before removing connector from vise and location fixture. Best results are obtained when contact location is flush to 0.004 (0.10) recessed from reference plane. Interface location fixture is pre-set at factory, but can be adjusted to control location.

Part Number	Cable Group
127-0692-101	MIL-C-17/151, 0.047 Semi-Rigid

Part Number	Tool
140-0000-962	Cable Vise
140-0000-981	Stop Screw
140-0000-997	Clamp Inserts
127-0000-902	Contact Holder
127-0000-903	Interface Location Fixture

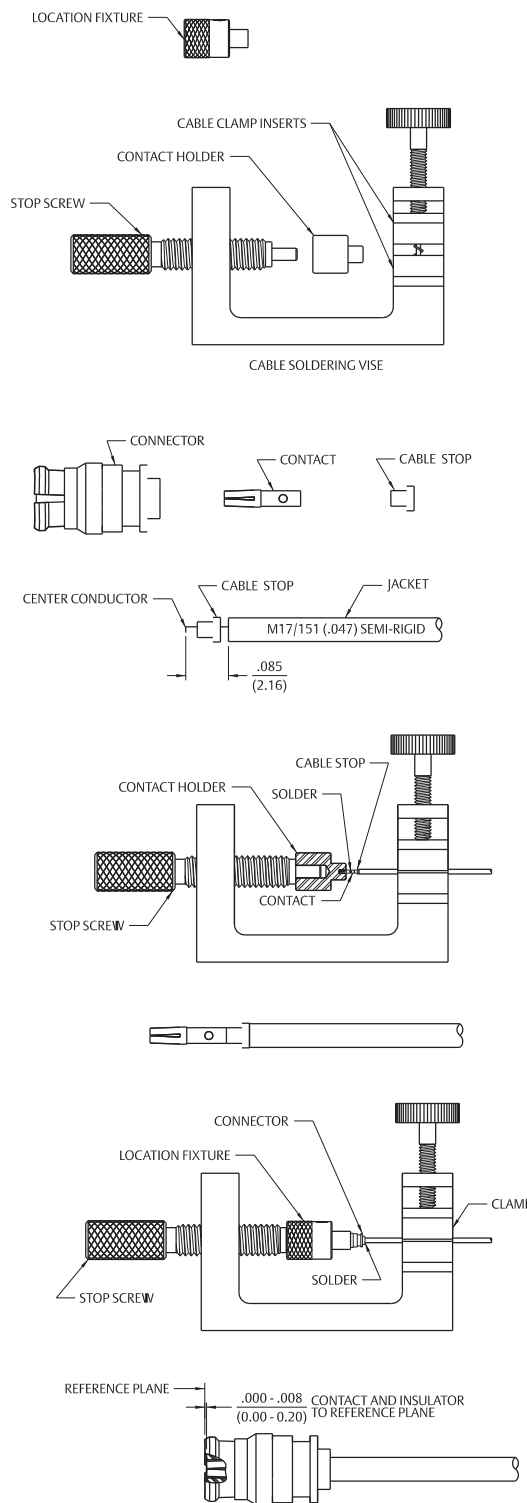

SMP Right Angle Female Solder Style for 0.047 OD Semi-Rigid Cable

1. Identify tools (5 piece parts) and connector parts (3 piece parts).
2. Strip cable jacket and dielectric to dimension shown. Do not nick center conductor. Clean all debris from prepared cable.
3. Insert center conductor into cable stop as shown. Make sure slot in connector contact is aligned with cross hole in body as shown. Insert cable into cross hole in connector body, making sure cable stop bottoms out against internal shoulder of connector body.
4. Insert connector assembly into interface location fixture and clamp cable in vise using body holder fixture as shown. Tighten stop screw until light pressure is applied between connector body, cable stop and cable jacket.
5. Solder contact to center conductor through rear access port in connector body using a minimum amount of solder and heat for a good joint.
6. After center conductor solder joint has cooled, solder connector body to cable jacket, using a minimum amount of solder and heat for a full fillet joint. Take care so that solder does not flow onto anti-rock ring or into rear access port. Allow assembly to cool before removing connector from vise and location fixture.
7. Using a fixture plate as shown, press end cap into rear access port using a 0.156 (3.96) diameter flat punch until fully seated within body counter bore.
8. Best results are obtained when contact location is flush to 0.004 (0.10) recessed from reference plane. Interface location fixture is pre-set at factory, but can be adjusted to control location.

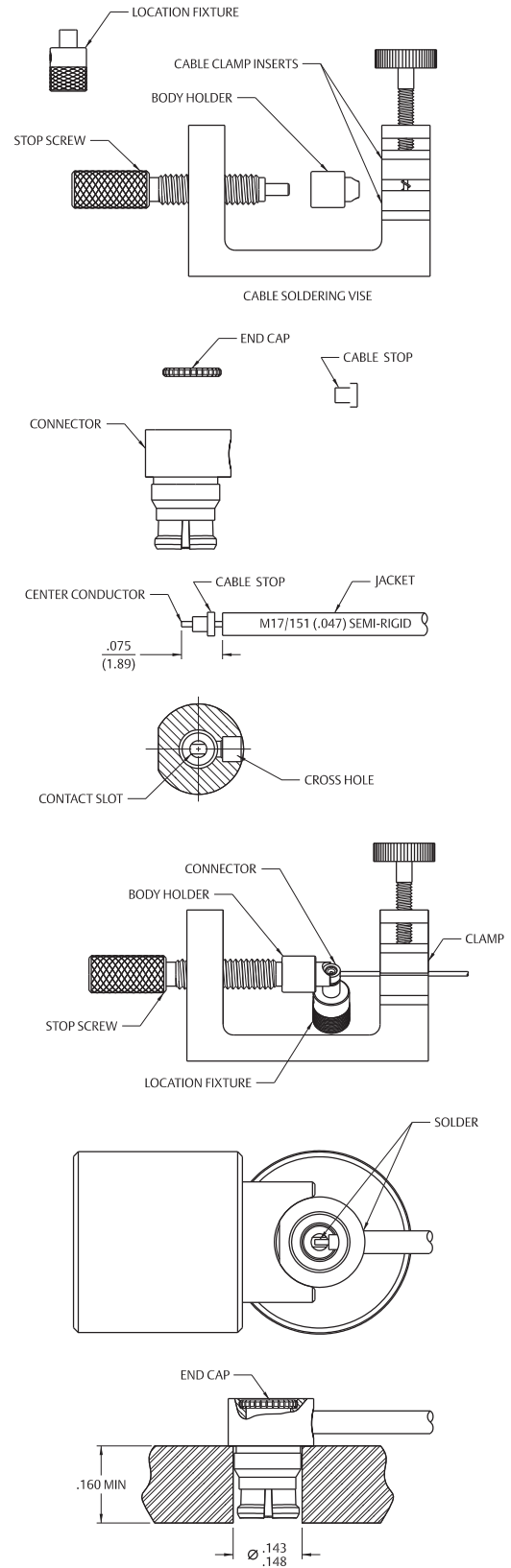

Part Number	Cable Group
127-0692-101	MIL-C-17/151, 0.047 Semi-Rigid

Part Number	Tool
140-0000-962	Cable Vise
140-0000-981	Stop Screw
140-0000-997	Clamp Inserts
127-0000-904	Body Holder
127-0000-903	Interface Location Fixture

SMP Straight Female Solder Style for 0.086 OD Semi-Rigid Cable

1. Identify tools (6 piece parts) and connector parts (2 piece parts).
2. Strip cable jacket and dielectric to dimension shown. Do not nick center conductor. Clean all debris from prepared cable.
3. Place contact onto center conductor, insert solder shim between cable jacket and contact.
4. Insert contact into contact holder fixture and clamp cable in vise. Tighten stop screw until light pressure is applied between contact, solder shim and cable jacket.
5. Solder contact to center conductor through solder hole using 0.016 (0.41) diameter flux core solder wire or solder paste. Use a minimum amount of solder and heat for a good joint.
6. After solder joint has cooled, remove solder shim and cable from vise. Remove any excess solder from contact with a sharp blade and clean all debris from contact and cable.
7. Insert contact into connector assembly, making sure cable jacket bottoms out against internal shoulder of connector body. Insert connector assembly into interface location fixture and clamp cable in vise. Make sure connector assembly is fully engaged within location fixture. Tighten stop screw until light pressure is applied between connector assembly and cable jacket.
8. Solder end of connector body to cable jacket, using a minimum amount of solder and heat for a full fillet joint. Allow assembly to cool before removing connector from vise and location fixture. Best results are obtained when contact location is flush to 0.004 (0.10) recessed from reference plane. Interface location fixture is preset at factory, but can be adjusted to control location.

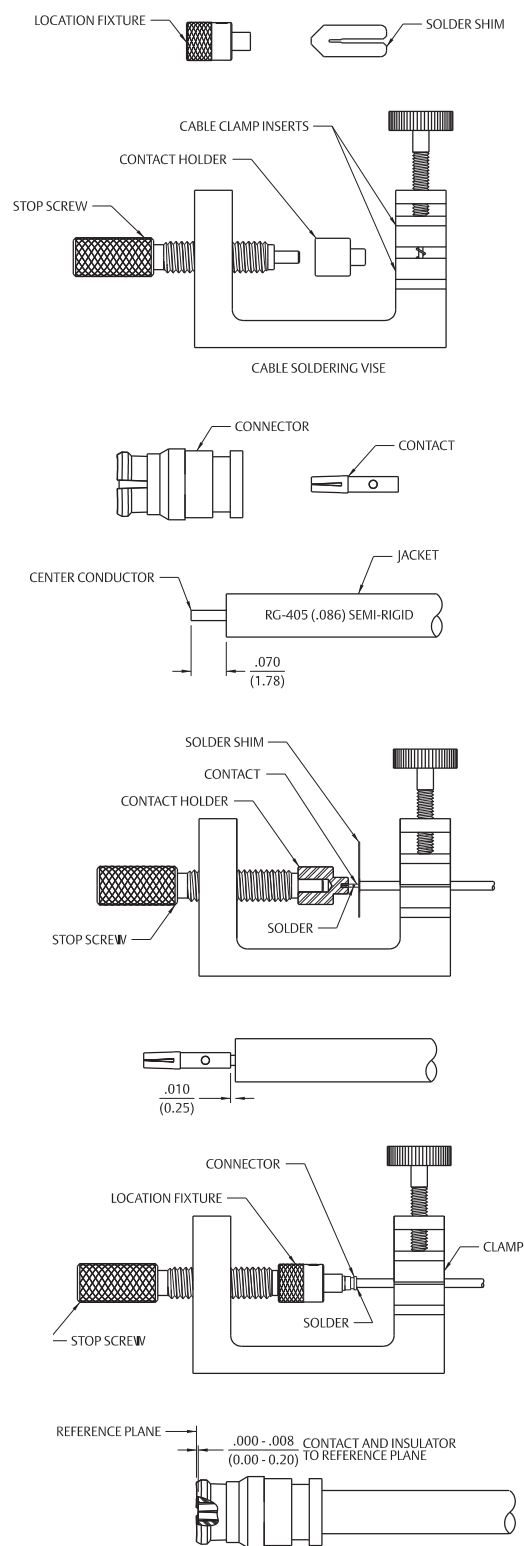

Part Number	Cable Group
127-0693-001	RG-405, 0.086 Semi-Rigid

Part Number	Tool
140-0000-962	Cable Vise
140-0000-981	Stop Screw
140-0000-964	Clamp Inserts
140-0000-984	Solder Shim
127-0000-902	Contact Holder
127-0000-903	Interface Location Fixture

SMP Right Angle Female Solder Style for 0.086 OD Semi-Rigid Cable

1. Identify tools (5 piece parts) and connector parts (2 piece parts).
2. Strip cable jacket and dielectric to dimension shown. Do not nick center conductor. Clean all debris from prepared cable.
3. Make sure slot in connector contact is aligned with cross hole in body as shown. Insert cable into cross hole in connector body, making sure cable jacket bottoms out against internal shoulder of connector body.
4. Insert connector assembly into interface location fixture and clamp cable in vise using body holder fixture as shown. Tighten stop screw until light pressure is applied between connector body and cable jacket.
5. Solder contact to center conductor through rear access port in connector body using a minimum amount of solder and heat for a good joint. Do not allow solder to build up along exposed center conductor.
6. After center conductor solder joint has cooled, solder connector body to cable jacket, using a minimum amount of solder and heat for a full fillet joint. Take care so that solder does not flow onto anti-rock ring or into rear access port. Allow assembly to cool before removing connector from vise and location fixture.
7. Using a fixture plate as shown, press end cap into rear access port using a 0.156 (3.96) diameter flat punch until fully seated within body counter bore.
8. Best results are obtained when contact location is flush to 0.004 (0.10) recessed from reference plane. Interface location fixture is preset at factory, but can be adjusted to control location.

Part Number	Cable Group
127-0693-101	RG-405, 0.086 Semi-Rigid

Part Number	Tool
140-0000-962	Cable Vise
140-0000-981	Stop Screw
140-0000-964	Clamp Inserts
127-0000-904	Body Holder
127-0000-903	Interface Location Fixture

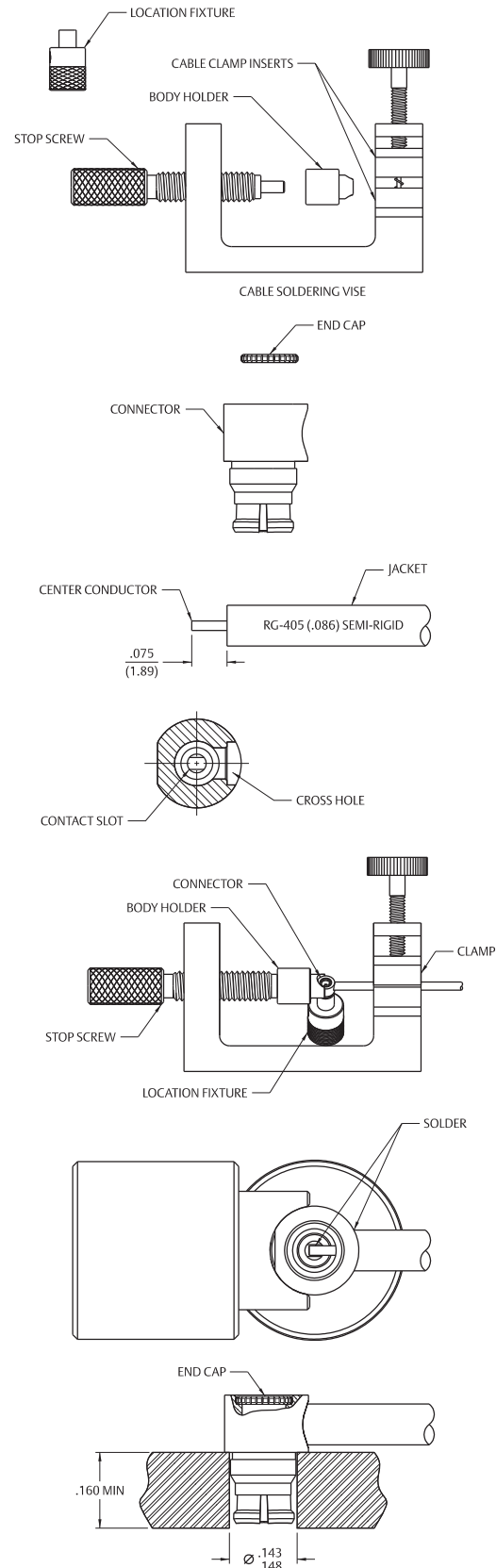

SMP Hermetic Seal Installation

1. Prepare housing panel per figure 2 as shown on page 6
2. Install solder ring on hermetic seal as shown. Recommended ring size is 0.103 (2.62) ID x 0.128 (3.25) OD x 0.015 (0.38) thick.
3. Solder in place as shown

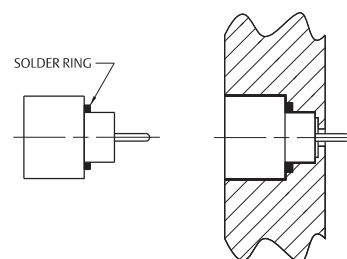
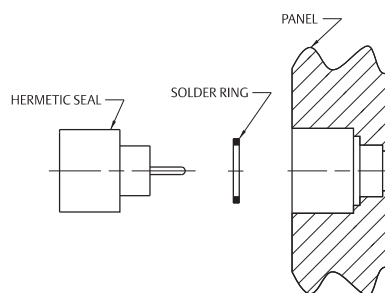

Part Number	Interface
127-0711-601	Full Detent
127-1711-601	Limited Detent
127-2711-601	Smooth Bore

SMP Shroud Installation

1. Install appropriate assembly tool into shroud as shown.
2. While holding tool in place, align flange mount with mounting holes in panel. Install fasteners and torque to 6-8 in/lbs.

Shroud Part Number	Tool Part Number
127-0701-602	127-0000-905
127-1701-602	127-0000-906
127-2701-602	127-0000-905
127-3701-602	127-0000-905

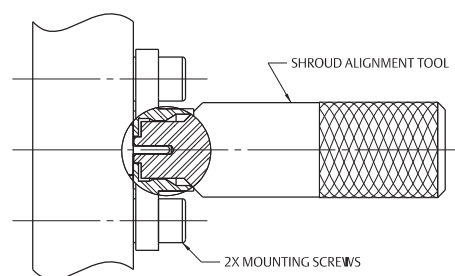

Competitor Cross Reference

Description	Johnson	Tensolite	Corning Gilbert	Micro-Mode	SV Microwave	AEP	Rosenberger
Straight Female M17/151 (0.047 SR) Cabled	127-0692-001	P651-1CC	A014-B11-01	MMSP-6120	1203-4000	7500-1582-011	19K101-270E4
Straight Female RG 405 (0.086 SR) Cabled	127-0693-001	P651-2CC	A014-D11-01	MMSP-2508	1204-4000	7500-1562-010	19K101-271E4
Right Angle Female M17/151 (0.047 SR) Cabled	127-0692-101	P652-1CC	A015-B11-01	MMSP-6968	1213-4006	7501-1562-011	19K202-270E4
Right Angle Female RG 405 (0.086 SR) Cabled	127-0693-101	P652-2CC	A015-D11-01	MMSP-2598	1214-4001	7501-1562-010	19K202-271E4
Field Replaceable 0.012 Socket 2 Hole Flange Male FD	127-0701-612	P836-4CCF	---	---	SF1250-6000	---	---
Field Replaceable 0.012 Socket 2 Hole Flange Male LD	127-1701-612	P836-5CCF	---	---	---	---	---
Field Replaceable 0.012 Socket 2 Hole Flange Male SB	127-2701-612	P836-6CCF	---	---	---	---	---
Adapter Bullet Female/Female 0.254	127-0901-801	P650-1CC	A1A1-0001-01	MMSP-2500	1290-4004	5280-1502-000	19K101-K00E4
Adapter Female/Female 0.769	127-0901-811	P617-1CC	---	MMSP-3829	1290-4007	5280-1502-001	19K115-K00E4
Adapter Male CM/Male FD	127-0901-822	P912-1CCSF	A3A6-0539-01	---	---	---	---
Adapter Male CM/Male LD	127-1901-822	P912-2CCSF	---	---	---	---	---
Adapter Male CM/Male SB	127-2901-822	P912-3CCSF	---	---	SF1293-6004	---	---
Shroud 2 Hole Flange 0.165 Wide x 0.400 High FD	127-0701-602	P670-3SF	A001-A23-04	MMSP-2514	SF1254-6006	---	---
Shroud 2 Hole Flange 0.165 Wide x 0.400 High LD	127-1701-602	P672-3SF	A001-A24-04	MMSP-6095	SF1254-6007	---	---
Shroud 2 Hole Flange 0.165 Wide x 0.400 High SB	127-2701-602	P673-3SF	A001-A25-04	MMSP-6067	SF1254-6008	---	---
Shroud 2 Hole Flange 0.235 Wide x 0.470 High CM	127-3701-602	P671-1SF	---	---	---	---	---
PC Mount Straight 0.218 OD 0.100 Legs Male FD	127-0701-201	P654-5CC	A008-L33-01	MMSP-7448	SF1287-6001	---	---
PC Mount Straight 0.218 OD 0.100 Legs Male LD	127-1701-201	P654-6CC	A008-L34-01	MMSP-7449	---	---	---
PC Mount Straight 0.218 OD 0.100 Legs Male SB	127-2701-201	P654-7CC	A008-L35-01	---	---	---	---
PC Mount Straight 0.235 OD 0.100 Legs Male CM	127-3701-201	P654-8CC	---	---	---	---	---
End Launch Surface Mount Male FD	127-0701-801	P606-1CC	A010-L13-02	MMSP-7457	---	---	---
End Launch Surface Mount Male LD	127-1701-801	P606-2CC	A010-L14-02	MMSP-3805	---	---	19S202-40ME4
End Launch Surface Mount Male SB	127-2701-801	P606-3CC	A010-L15-02	MMSP-7347	---	---	---
Hermetic Feedthrough Shroud Male FD	127-0711-601	P840-9CC	A007-L43-01-70	MMSP-2771	---	---	---
Hermetic Feedthrough Shroud Male LD	127-1711-601	P794-2CC	A007-L44-01-70	MMSP-2875	---	---	---
Hermetic Feedthrough Shroud Male SB	127-2711-601	---	A007-L45-01-70	MMSP-2979	---	---	---