

SYMBOL DEFINITION		
A DIMENSION WITHOUT AN INSPECTION REPORT SYMBOL  DOES NOT REQUIRE INSPECTION. IT MAY BE CONTROLLED ON THE INDIVIDUAL COMPONENT DRAWING.	TOTAL NO OF INSPECTIONS REQUIRED	22
	LAST NO. USED	20

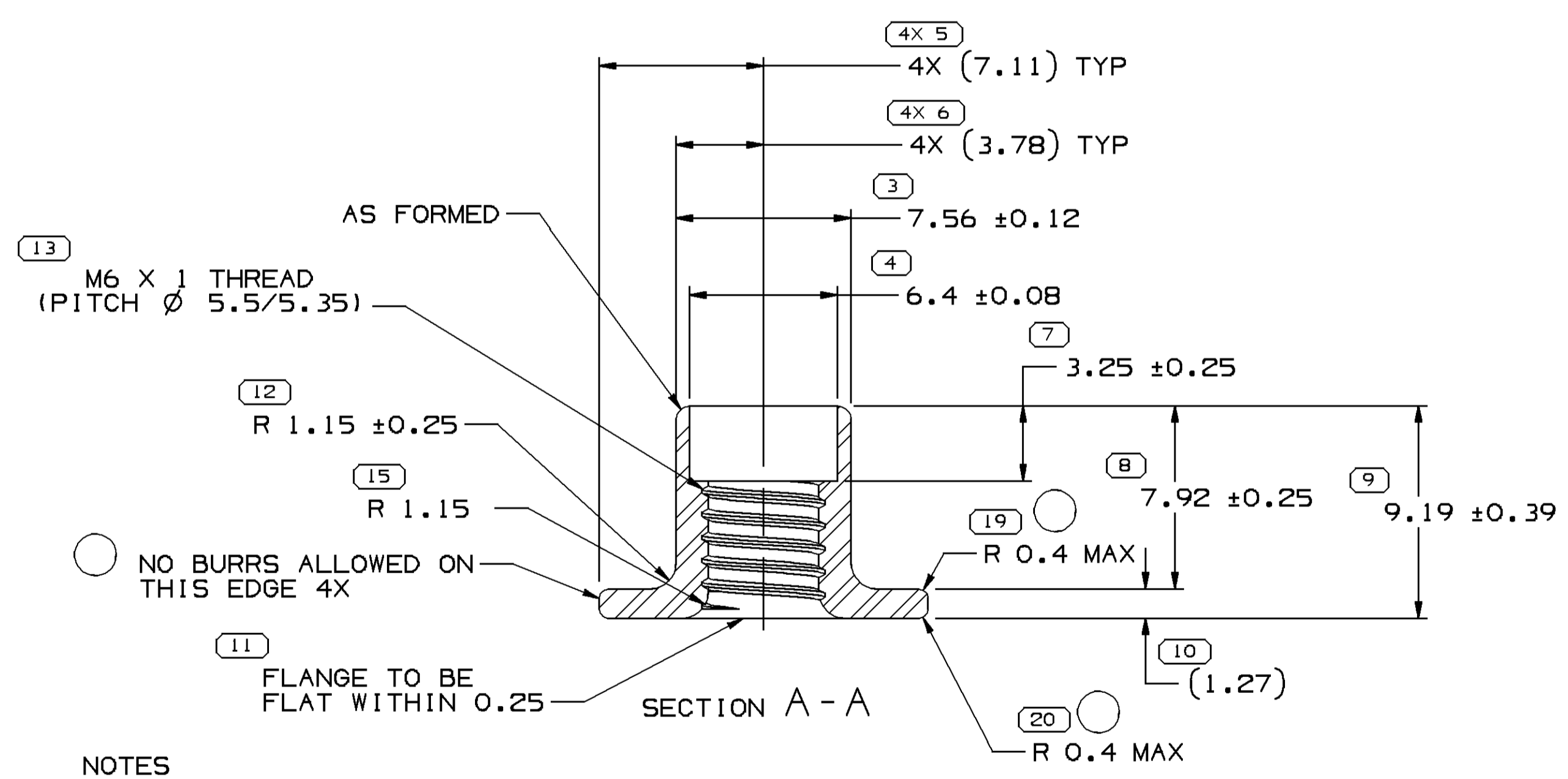

MISSING SYMBOLS	
14	16-18

DWG STATUS					ZONE	REVISION HISTORY				AUTH	DR	APVD 1	APVD 2
DATE	STG	REV	N/P	CHG									
11MY04	R	01	-	-		RELEASED				255221	CTR	JAA	MGR
09AP07	R	01	AA	-		ADDED DIM(S) (3 PLCS)				290798	EFS	RAO	JC
09MY07	R	01	AB	-		DELETED DIMS 14 & 16				291751	RAG	EAT	JC
08JN07	R	01	AC	-		ADDED DIM* (2 PLCS), ADDED NOTE				292671	PMP	JMM	JC

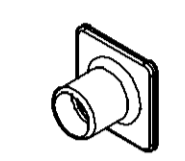
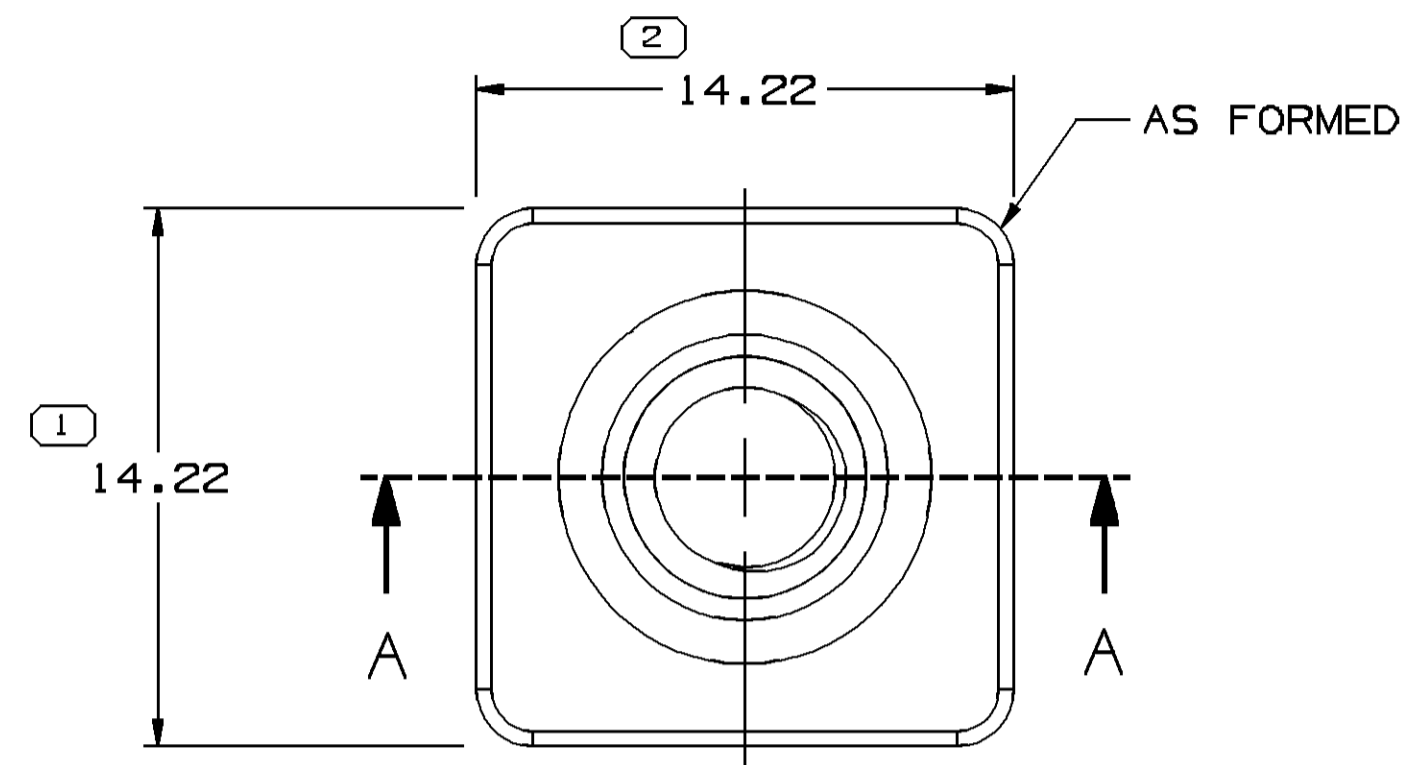

- NOTES
- UNLESS OTHERWISE SPECIFIED AND/OR INDICATED: DIMENSIONS ARE TO FACE OF VIEW SHOWN AND AUTOMATICALLY ROUNDED BY COMPUTER FOR INSPECTION (SEE MATH MODEL FOR PRECISE DIMENSIONS). FOR ALL OTHER DIMENSIONS NOT SHOWN BUT REQUIRED FOR TOOL BUILD, SEE MATH MODEL FOR PRECISE TOOL PATH DATA. ALL RADII 0.4
 - THIS PART MUST MEET A MINIMUM TORQUE REQUIREMENT OF 13.6 NM.

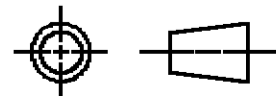
(N/A)	PROCESS SENSITIVE DIMENSION
DIMENSIONS ENCLOSED IN () INDICATE REFERENCE DIMENSIONS AND NO TOLERANCE LIMITS ARE ESTABLISHED	
DIMENSIONAL RANGE (MM)	CHART 6
FROM 0	> 12
TO 12	
TOLERANCE UNLESS OTHERWISE SPECIFIED	
±0.15	±0.3
ANGULAR TOLERANCE ±2°	

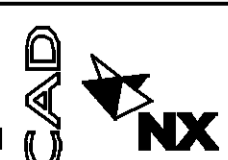
DWG TYPE		PART DRAWING	
STYLE			
VOLUME (CM³)		DISTR CODE	
		D	
UNLESS OTHERWISE SPECIFIED			
THIS DOCUMENT IS IN ACCORDANCE WITH ASME Y14.5M-1994 AS AMENDED BY THE GM GLOBAL DIMENSIONING AND TOLERANCING ADDENDUM-2001. SEPARATE PATTERNS OF FEATURES MAY BE GAGED SEPARATELY REGARDLESS OF DATUM REFERENCES.			
ALL DIMENSIONS ARE IN MILLIMETERS			
REFERENCE			
THIRD ANGLE PROJECTION		DO NOT SCALE	
			
		USE MATH DATA	
			

DELPHI			
DELPHI PACKARD ELECTRICAL/ELECTRONIC ARCHITECTURE WARREN, OH			
DR		DATE	
APVD1	CESAR TAPIA R.	01JN04	
APVD2	J.S. ALVARADO	25JN04	
APVD3	M. ROUSSEL	25JN04	
APVD4			
APVD5			
SUBSTANCES OF CONCERN AND RECYCLED CONTENT PER DELPHI 10949001			
MATERIAL			
SAE 1010 STEEL PLATED PER DX551245-P			
DRAWING NAME			
SLEV INSERT NUT M6			
DRAWING NUMBER			
15492560			
SIZE	SCALE	FRAME NO	SHEET NO
A2	5:1	1 OF 1	1 OF 1
STG	REV	N/P	
R	01	AC	