

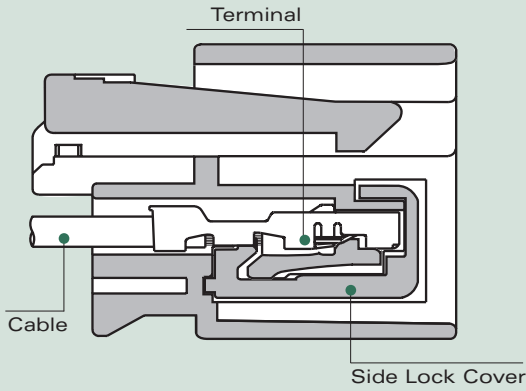

Cross Sectional View

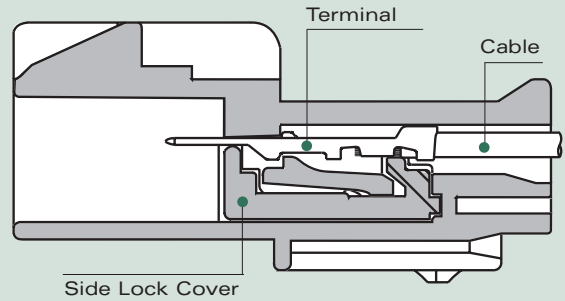

Female Connector Assembly



Male Connector Assembly

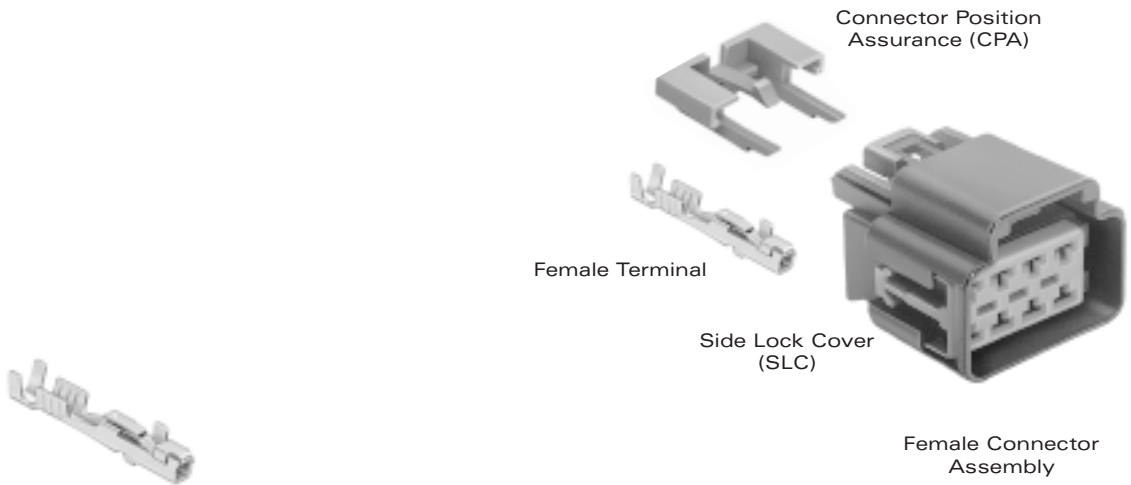

GT 150 FEMALE TERMINALS UNSEALED

Part #	Cable Range (mm ²)	Material	Plating
12191811	0.50-0.35	Tin Brass	Tin
12191812	1.00-0.75	Tin Brass	Tin

GT 150 FEMALE CONNECTOR ASSEMBLIES UNSEALED

# Cavities	Connector	Color	Material
2	15332129	Black	PA6 10% GF & 20% GB
3	15332132	Black	PA6 10% GF & 20% GB
4	15332135	Black	PA6 10% GF & 20% GB
5	15332138	Black	PA6 10% GF & 20% GB
6	15332141	Black	PA6 10% GF & 20% GB
8	15332145	Black	PA6 10% GF & 20% GB
10	15332153	Black	PA6 10% GF & 20% GB
12	15332161	Black	PA6 10% GF & 20% GB
14	15332169	Black	PA6 10% GF & 20% GB
16	15332177	Black	PA6 10% GF & 20% GB

Side Lock Covers (SLC) are included in the Connector Assemblies listed in this section.

<http://delphi.com/products/connect>



Unsealed System Application Information

CABLE RANGE (mm²): 0.35-1.0
CURRENT RANGE (AMPS): 0-15
TEMP RANGE °C: -40 to 125
RESISTANCE: <10mΩ@20mV
VOLTAGE DROP: <10.0mV/amp
CENTERLINE SPACING (mm): 4.0
BLADE WIDTH (mm): 1.5

GT 150 SERIES TERMINALS-Tin Plated

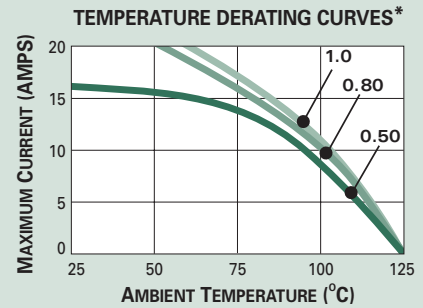
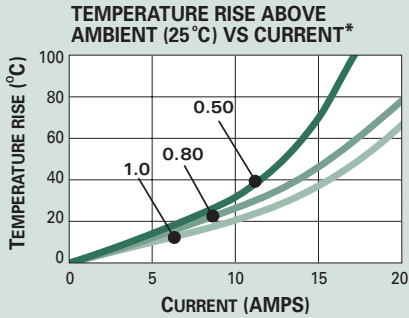

*The test data are based on single circuits in free space and were generated using a "Lumped Resistance" model. This model does not account for all of the variables that would be present in an actual application. For actual product performance, contact your regional support representative at the number listed below.

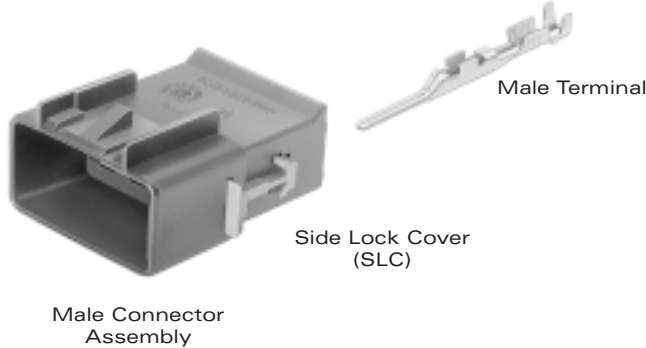

GT 150 MALE CONNECTOR ASSEMBLIES UNSEALED

# Cavities	Connector	Color	Material
2	15332130	Black	PA6 10% GF & 20% GB
3	15332133	Black	PA6 10% GF & 20% GB
4	15332136	Black	PA6 10% GF & 20% GB
5	15332139	Black	PA6 10% GF & 20% GB
6	15332142	Black	PA6 10% GF & 20% GB
8	15332150	Black	PA6 10% GF & 20% GB
10	15332158	Black	PA6 10% GF & 20% GB
12	15332166	Black	PA6 10% GF & 20% GB
14	15332174	Black	PA6 10% GF & 20% GB
16	15332182	Black	PA6 10% GF & 20% GB

Side Lock Covers (SLC) are included in the Connector Assemblies listed in this section.

GT 150 MALE TERMINALS UNSEALED

Part #	Cable Range (mm ²)	Material	Plating
15304701	0.50-0.35	Tin Brass	Tin
15304702	1.00-0.75	Tin Brass	Tin

SECTION NOTES:

- Contact your regional support representative at the number listed below.
- Due to rigid tolerances of connector cavities, it is critical to meet all crimp dimensions as specified.

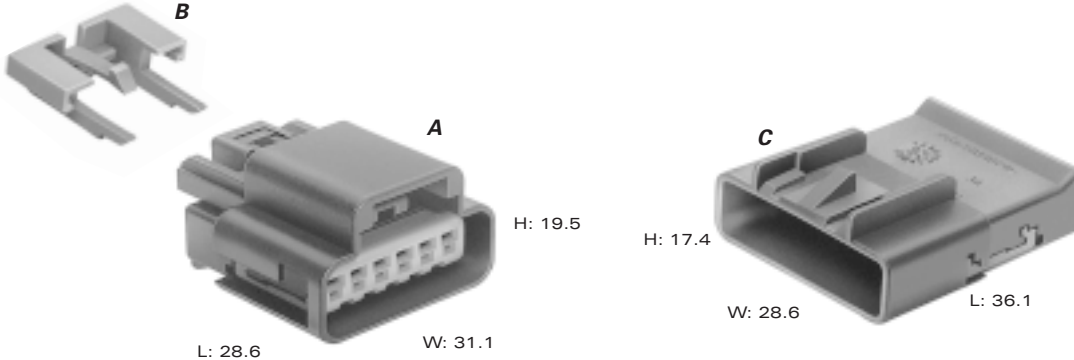

Total Mated Length: 52.1mm

A PART NO: 15332129
 DESCRIPTION: Connector Assembly 2F
 SIZE: 28.6L x 19.5H x 15.1W
 COLOR: Black
 MATERIAL: PA6 10% GF & 20% GB
 TERMINALS: See Page 10

C PART NO: 15332130
 DESCRIPTION: Connector Assembly 2M
 SIZE: 36.1L x 17.4H x 12.6W
 COLOR: Black
 MATERIAL: PA6 10% GF & 20% GB
 TERMINALS: See Page 11

PART NO: 15332132
 DESCRIPTION: Connector Assembly 3F
 SIZE: 28.6L x 19.5H x 19.1W
 COLOR: Black
 MATERIAL: PA6 10% GF & 20% GB
 TERMINALS: See Page 10

PART NO: 15332133
 DESCRIPTION: Connector Assembly 3M
 SIZE: 36.1L x 17.4H x 16.6W
 COLOR: Black
 MATERIAL: PA6 10% GF & 20% GB
 TERMINALS: See Page 11

PART NO: 15332135
 DESCRIPTION: Connector Assembly 4F
 SIZE: 28.6L x 19.5H x 23.1W
 COLOR: Black
 MATERIAL: PA6 10% GF & 20% GB
 TERMINALS: See Page 10

PART NO: 15332136
 DESCRIPTION: Connector Assembly 4M
 SIZE: 36.1L x 17.4H x 20.6W
 COLOR: Black
 MATERIAL: PA6 10% GF & 20% GB
 TERMINALS: See Page 11

PART NO: 15332138
 DESCRIPTION: Connector Assembly 5F
 SIZE: 28.6L x 19.5H x 27.1W
 COLOR: Black
 MATERIAL: PA6 10% GF & 20% GB
 TERMINALS: See Page 10

PART NO: 15332139
 DESCRIPTION: Connector Assembly 5M
 SIZE: 36.1L x 17.4H x 24.6W
 COLOR: Black
 MATERIAL: PA6 10% GF & 20% GB
 TERMINALS: See Page 11

PART NO: 15332141
 DESCRIPTION: Connector Assembly 6F
 SIZE: 28.6L x 19.5H x 31.1W
 COLOR: Black
 MATERIAL: PA6 10% GF & 20% GB
 TERMINALS: See Page 10

PART NO: 15332142
 DESCRIPTION: Connector Assembly 6M
 SIZE: 36.1L x 17.4H x 28.6W
 COLOR: Black
 MATERIAL: PA6 10% GF & 20% GB
 TERMINALS: See Page 11

B PART NO: 15317832
 DESCRIPTION: CPA
 COLOR: Gray
 MATERIAL: PA6 10% GF & 20% GB

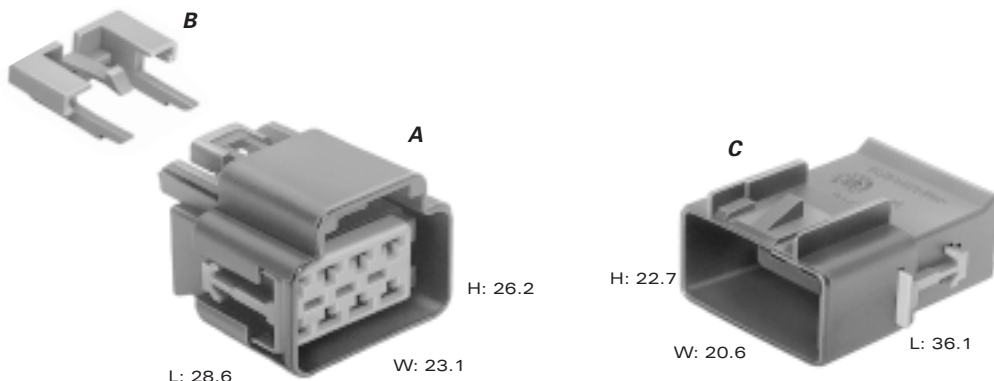

Total Mated Length: 52.1mm

A PART NO: 15332145
 DESCRIPTION: Connector Assembly 8F
 SIZE: 28.6L x 26.2H x 23.1W
 COLOR: Black
 MATERIAL: PA6 10% GF & 20% GB
 TERMINALS: See Page 10

PART NO: 15332153
 DESCRIPTION: Connector Assembly 10F
 SIZE: 28.6L x 26.2H x 27.1W
 COLOR: Black
 MATERIAL: PA6 10% GF & 20% GB
 TERMINALS: See Page 10

PART NO: 15332161
 DESCRIPTION: Connector Assembly 12F
 SIZE: 28.6L x 26.2H x 31.1W
 COLOR: Black
 MATERIAL: PA6 10% GF & 20% GB
 TERMINALS: See Page 10

PART NO: 15332169
 DESCRIPTION: Connector Assembly 14F
 SIZE: 28.6L x 26.2H x 35.1W
 COLOR: Black
 MATERIAL: PA6 10% GF & 20% GB
 TERMINALS: See Page 10

PART NO: 15332177
 DESCRIPTION: Connector Assembly 16F
 SIZE: 28.6L x 26.2H x 39.1W
 COLOR: Black
 MATERIAL: PA6 10% GF & 20% GB
 TERMINALS: See Page 10

B PART NO: 15317832
 DESCRIPTION: CPA
 COLOR: Gray
 MATERIAL: PA6 10% GF & 20% GB

C PART NO: 15332150
 DESCRIPTION: Connector Assembly 8M
 SIZE: 36.1L x 22.7H x 20.6W
 COLOR: Black
 MATERIAL: PA6 10% GF & 20% GB
 TERMINALS: See Page 11

PART NO: 15332158
 DESCRIPTION: Connector Assembly 10M
 SIZE: 36.1L x 22.7H x 24.6W
 COLOR: Black
 MATERIAL: PA6 10% GF & 20% GB
 TERMINALS: See Page 11

PART NO: 15332166
 DESCRIPTION: Connector Assembly 12M
 SIZE: 36.1L x 22.7H x 28.6W
 COLOR: Black
 MATERIAL: PA6 10% GF & 20% GB
 TERMINALS: See Page 11

PART NO: 15332174
 DESCRIPTION: Connector Assembly 14M
 SIZE: 36.1L x 22.7H x 32.6W
 COLOR: Black
 MATERIAL: PA6 10% GF & 20% GB
 TERMINALS: See Page 11

PART NO: 15332182
 DESCRIPTION: Connector Assembly 16M
 SIZE: 36.1L x 22.7H x 36.6W
 COLOR: Black
 MATERIAL: PA6 10% GF & 20% GB
 TERMINALS: See Page 11



Cross Sectional View

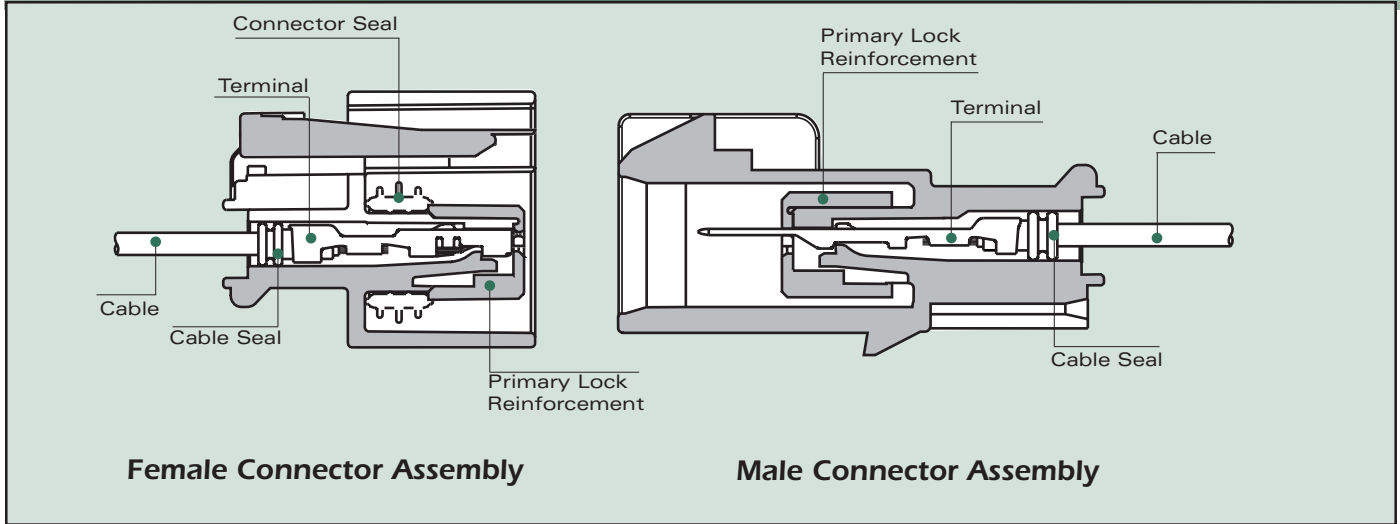

Connector Position Assurance (CPA)

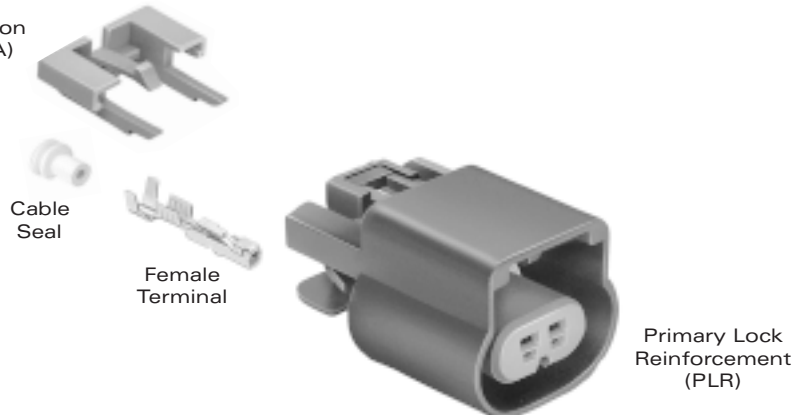

GT 150 FEMALE TERMINALS SEALED

Part #	Cable Range (mm ²)	Material	Plating
12191818	0.50-0.35	Tin Brass	Tin
12191819	1.00-0.75	Tin Brass	Tin

GT 150 FEMALE CONNECTOR ASSEMBLIES SEALED

# Cavities	Connector	Color	Material
2	15326801	Black	PA6 10% GF & 20% GB
3	15326808	Black	PA6 10% GF & 20% GB
4	15326815	Black	PA6 10% GF & 20% GB
5	15326822	Black	PA6 10% GF & 20% GB
6	15326829	Black	PA6 10% GF & 20% GB
8	15326835	Black	PA6 10% GF & 20% GB
10	15326842	Black	PA6 10% GF & 20% GB
12	15326849	Black	PA6 10% GF & 20% GB
14	15326856	Black	PA6 10% GF & 20% GB
16	15326863	Black	PA6 10% GF & 20% GB

GT 150 CABLE SEALS

Reel Part #	Loose Part #	Cable Diameter	Material	Color
12191152	15366021	1.20-1.85	Silicone	White
12191153	15366060	1.86-2.25	Silicone	Blue

Primary Lock Reinforcement (PLR) and Connector Seals are included in the Connector Assemblies listed in this section.

<http://delphi.com/products/connect>



Sealed System Application Information

CABLE RANGE (mm²): 0.35-1.0
CURRENT RANGE (AMPS): 0-15
TEMP RANGE °C: -40 to 125
RESISTANCE: <10mΩ@20mV
VOLTAGE DROP: <10.0mV/amp
CENTERLINE SPACING (mm):..... 4.5
BLADE WIDTH (mm):..... 1.5

GT 150 SERIES TERMINALS-Tin Plated

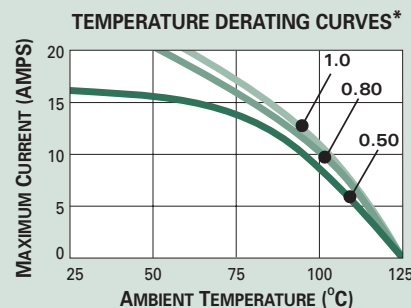
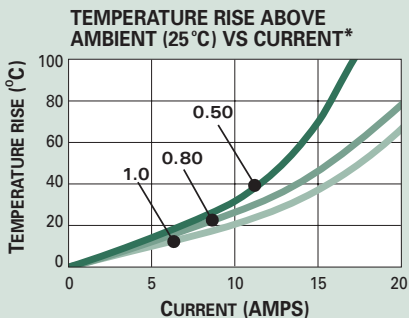

*The test data are based on single circuits in free space and were generated using a "Lumped Resistance" model. This model does not account for all of the variables that would be present in an actual application. For actual product performance, contact your regional support representative at the number listed below.

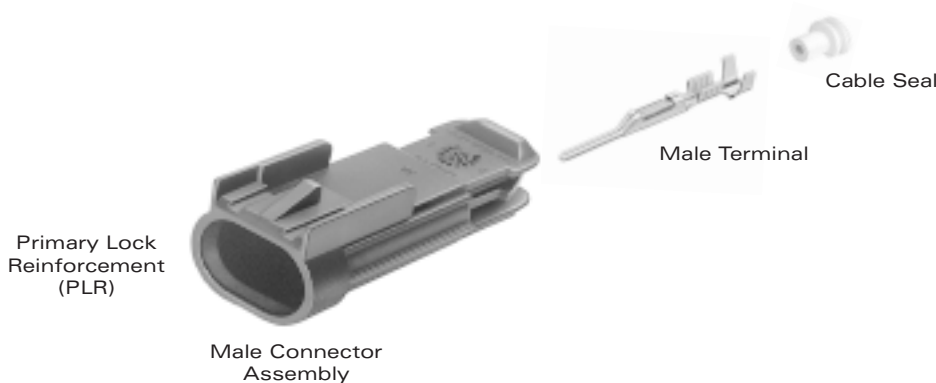

GT 150 MALE CONNECTOR ASSEMBLIES SEALED			
# Cavities	Connector	Color	Material
2	15326806	Black	PA6 10% GF & 20% GB
3	15326813	Black	PA6 10% GF & 20% GB
4	15326820	Black	PA6 10% GF & 20% GB
5	15326827	Black	PA6 10% GF & 20% GB
6	15326833	Black	PA6 10% GF & 20% GB
8	15326840	Black	PA6 10% GF & 20% GB
10	15326847	Black	PA6 10% GF & 20% GB
12	15326854	Black	PA6 10% GF & 20% GB
14	15326861	Black	PA6 10% GF & 20% GB
16	15326868	Black	PA6 10% GF & 20% GB

Primary Lock Reinforcement (PLR) is included in the Connector Assemblies listed in this section.

GT 150 MALE TERMINALS SEALED			
Part #	Cable Range (mm ²)	Material	Plating
15326268	0.50-0.35	Tin Brass	Tin
15326269	1.00-0.75	Tin Brass	Tin

GT 150 CAVITY PLUG*			
Part #	Cavity Diameter	Material	Color
15305171	4.0mm	Silicone	Green

*Cavity plugs seal unused female and male cavities.

SECTION NOTES:

Contact your regional support representative at the number listed below.

- Due to rigid tolerances of connector cavities, it is critical to meet all crimp dimensions as specified.

<http://delphi.com/products/connect>

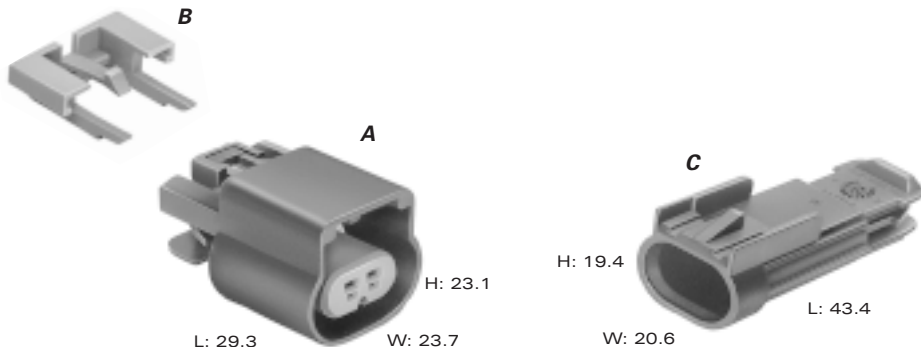

Total Mated Length: 56.7mm

A PART NO: 15326801
 DESCRIPTION: Connector Assembly 2F
 SIZE: 29.3L x 23.1H x 23.7W
 COLOR: Black
 MATERIAL: PA6 10% GF & 20% GB
 TERMINALS: See Page 14
 SEALS/PLUGS: See Page 14, 15

C PART NO: 15326806
 DESCRIPTION: Connector Assembly 2M
 SIZE: 43.4L x 19.4H x 20.6W
 COLOR: Black
 MATERIAL: PA6 10% GF & 20% GB
 TERMINALS: See Page 15
 SEALS/PLUGS: See Page 14, 15

PART NO: 15326808
 DESCRIPTION: Connector Assembly 3F
 SIZE: 29.3L x 23.1H x 28.2W
 COLOR: Black
 MATERIAL: PA6 10% GF & 20% GB
 TERMINALS: See Page 14
 SEALS/PLUGS: See Page 14, 15

PART NO: 15326813
 DESCRIPTION: Connector Assembly 3M
 SIZE: 43.4L x 19.4H x 25.1W
 COLOR: Black
 MATERIAL: PA6 10% GF & 20% GB
 TERMINALS: See Page 15
 SEALS/PLUGS: See Page 14, 15

PART NO: 15326815
 DESCRIPTION: Connector Assembly 4F
 SIZE: 29.3L x 23.1H x 32.7W
 COLOR: Black
 MATERIAL: PA6 10% GF & 20% GB
 TERMINALS: See Page 14
 SEALS/PLUGS: See Page 14, 15

PART NO: 15326820
 DESCRIPTION: Connector Assembly 4M
 SIZE: 43.4L x 19.4H x 29.6W
 COLOR: Black
 MATERIAL: PA6 10% GF & 20% GB
 TERMINALS: See Page 15
 SEALS/PLUGS: See Page 14, 15

PART NO: 15326822
 DESCRIPTION: Connector Assembly 5F
 SIZE: 29.3L x 23.1H x 37.2W
 COLOR: Black
 MATERIAL: PA6 10% GF & 20% GB
 TERMINALS: See Page 14
 SEALS/PLUGS: See Page 14, 15

PART NO: 15326827
 DESCRIPTION: Connector Assembly 5M
 SIZE: 43.4L x 19.4H x 34.1W
 COLOR: Black
 MATERIAL: PA6 10% GF & 20% GB
 TERMINALS: See Page 15
 SEALS/PLUGS: See Page 14, 15

PART NO: 15326829
 DESCRIPTION: Connector Assembly 6F
 SIZE: 29.3L x 23.1H x 41.7W
 COLOR: Black
 MATERIAL: PA6 10% GF & 20% GB
 TERMINALS: See Page 14
 SEALS/PLUGS: See Page 14, 15

PART NO: 15326833
 DESCRIPTION: Connector Assembly 6M
 SIZE: 43.4L x 19.4H x 38.6W
 COLOR: Black
 MATERIAL: PA6 10% GF & 20% GB
 TERMINALS: See Page 15
 SEALS/PLUGS: See Page 14, 15

B PART NO: 15317832
 DESCRIPTION: CPA
 COLOR: Gray
 MATERIAL: PA6 10% GF & 20% GB

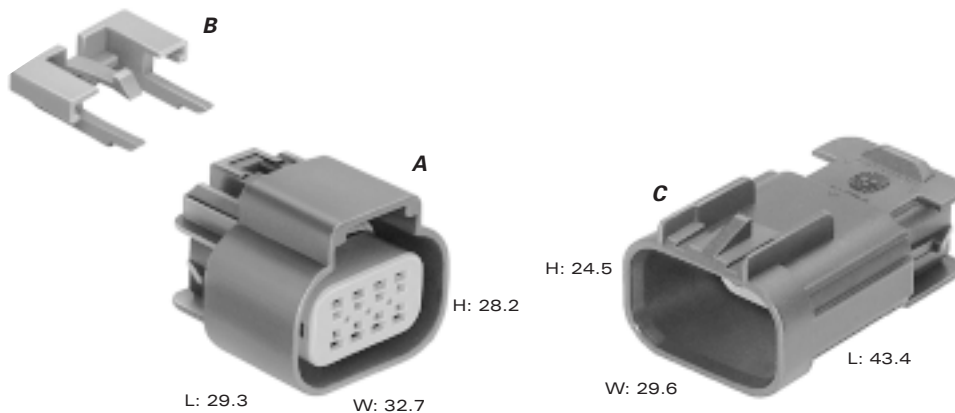

Total Mated Length: 56.7mm

A PART NO: 15326835
 DESCRIPTION: Connector Assembly 8F
 SIZE: 29.3L x 28.2H x 32.7W
 COLOR: Black
 MATERIAL: PA6 10% GF & 20% GB
 TERMINALS: See Page 14
 SEALS/PLUGS: See Page 14, 15

PART NO: 15326842
 DESCRIPTION: Connector Assembly 10F
 SIZE: 29.3L x 28.2H x 37.2W
 COLOR: Black
 MATERIAL: PA6 10% GF & 20% GB
 TERMINALS: See Page 14
 SEALS/PLUGS: See Page 14, 15

PART NO: 15326849
 DESCRIPTION: Connector Assembly 12F
 SIZE: 29.3L x 28.2H x 41.7W
 COLOR: Black
 MATERIAL: PA6 10% GF & 20% GB
 TERMINALS: See Page 14
 SEALS/PLUGS: See Page 14, 15

PART NO: 15326856
 DESCRIPTION: Connector Assembly 14F
 SIZE: 29.3L x 28.2H x 46.2W
 COLOR: Black
 MATERIAL: PA6 10% GF & 20% GB
 TERMINALS: See Page 14
 SEALS/PLUGS: See Page 14, 15

PART NO: 15326863
 DESCRIPTION: Connector Assembly 16F
 SIZE: 29.3L x 28.2H x 50.7W
 COLOR: Black
 MATERIAL: PA6 10% GF & 20% GB
 TERMINALS: See Page 14
 SEALS/PLUGS: See Page 14, 15

B PART NO: 15317832
 DESCRIPTION: CPA
 COLOR: Gray
 MATERIAL: PA6 10% GF & 20% GB

C PART NO: 15326840
 DESCRIPTION: Connector Assembly 8M
 SIZE: 43.4L x 24.5H x 29.6W
 COLOR: Black
 MATERIAL: PA6 10% GF & 20% GB
 TERMINALS: See Page 15
 SEALS/PLUGS: See Page 14, 15

PART NO: 15326847
 DESCRIPTION: Connector Assembly 10M
 SIZE: 43.4L x 24.5H x 34.1W
 COLOR: Black
 MATERIAL: PA6 10% GF & 20% GB
 TERMINALS: See Page 15
 SEALS/PLUGS: See Page 14, 15

PART NO: 15326854
 DESCRIPTION: Connector Assembly 12M
 SIZE: 43.4L x 24.5H x 38.6W
 COLOR: Black
 MATERIAL: PA6 10% GF & 20% GB
 TERMINALS: See Page 15
 SEALS/PLUGS: See Page 14, 15

PART NO: 15326861
 DESCRIPTION: Connector Assembly 14M
 SIZE: 43.4L x 24.5H x 43.1W
 COLOR: Black
 MATERIAL: PA6 10% GF & 20% GB
 TERMINALS: See Page 15
 SEALS/PLUGS: See Page 14, 15

PART NO: 15326868
 DESCRIPTION: Connector Assembly 16M
 SIZE: 43.4L x 24.5H x 47.6W
 COLOR: Black
 MATERIAL: PA6 10% GF & 20% GB
 TERMINALS: See Page 15
 SEALS/PLUGS: See Page 14, 15



Sealed System Application Information

CABLE RANGE (mm²): 0.35-1.0
 CURRENT RANGE (AMPS): 0-15
 TEMP RANGE °C: -40 to 125
 RESISTANCE: <10mΩ@20mV
 VOLTAGE DROP: <10.0mV/amp
 CENTERLINE SPACING (mm): 3.5
 BLADE WIDTH (mm): 1.5

GT 150 SERIES TERMINALS-Tin Plated

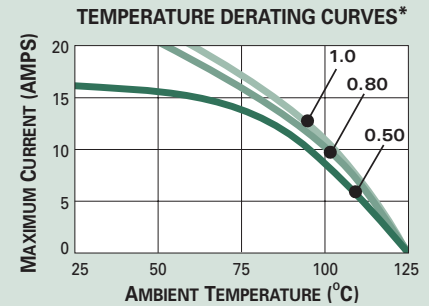
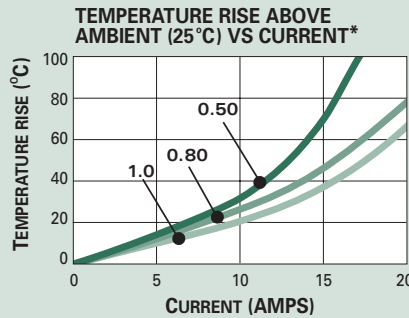

*The test data are based on single circuits in free space and were generated using a "Lumped Resistance" model. This model does not account for all of the variables that would be present in an actual application. For actual product performance, contact your regional support representative at the number listed below.

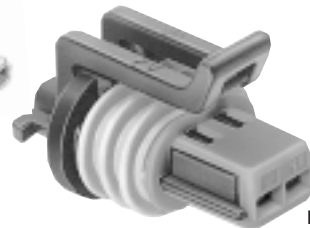

Mushroom Indexed Primary Lock Reinforcement (PLR)



GT 150 FEMALE TERMINALS SEALED

Part #	Cable Range (mm ²)	Material	Plating
15326266	0.50-0.35	Tin Brass	Tin
15305350	1.00*-0.75	Tin Brass	Tin

*Accommodates 1.00 European Ultra Thin Wall Cable.
 Accomdates 0.80 SAE Ultra Thin Wall Cable

GT 150 FEMALE UNSHROUDED CONNECTOR ASSEMBLIES SEALED

# Cavities	Conn. Asm.	Indexing	Color	Material
2	15336024	Mushroom	Black	PA6 10% GF & 20% GB
2 TBI	15336027	Mushroom	Black	PA6 10% GF & 20% GB
3	15336029	Mushroom	Black	PA6 10% GF & 20% GB
4	15354716	Mushroom	Black	PA6 10% GF & 20% GB

GT 150 CABLE SEALS

Reel Part #	Loose Part #	Cable Diameter	Material	Color
12191155	15366022	1.47-1.85	Silicone	Green
—	15305351	1.70-2.10	Silicone	Yellow

GT 150 CAVITY PLUG*

Part #	Material	Color
15305169	Silicone	Orange

*Cavity plugs seal unused female and male cavities.

<http://delphi.com/products/connect>

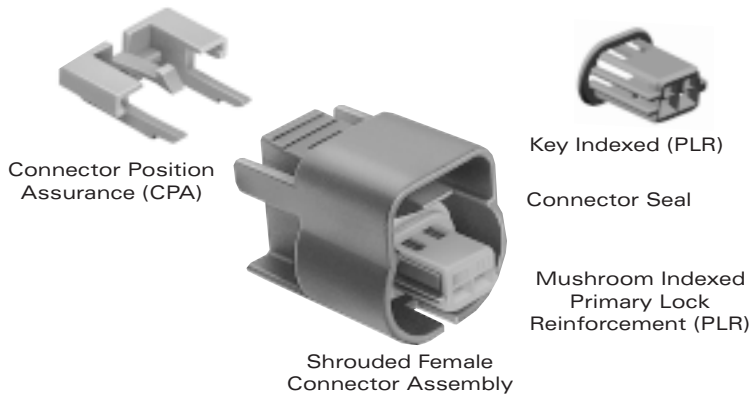

GT 150 FEMALE SHROUDED CONNECTOR ASSEMBLIES SEALED

# Cavities	Conn. Asm.	Indexing	Color	Material
2	15336004	Mushroom	Black	PA6 10% GF & 20% GB
2	15355317	Mushroom	Black	PBT 20% GF
3	15336121	Mushroom	Black	PA66 HS IM
3	15355323	Mushroom	Black	PBT 20% GF
4	15355331	Mushroom	Black	PA66 HS IM
4	15355331	Mushroom	Black	PBT 20% GF
5	15326389	Mushroom	Black	PA66 HS IM
5	15355268	Mushroom	Black	PBT 20% GF
6	15336013	Mushroom	Black	PBT 20% GF
<hr/>				
2	15335987	Key	Black	PA6 10% GF & 20% GB
2	15355319	Key	Black	PBT 20% GF
3	15326556	Key	Black	PA66 HS IM
3	15355325	Key	Black	PBT 20% GF
4	15336001	Key	Black	PA66 HS IM
4	15355329	Key	Black	PBT 20% GF

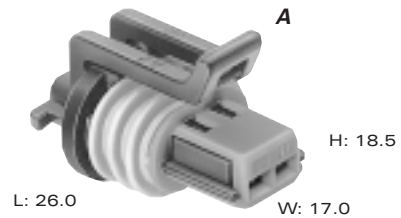

Unshrouded Female Mushroom Indexed

A PART NO: 15336024
 DESCRIPTION: Connector Assembly 2F
 SIZE: 26.0L x 18.5H x 17.0W
 COLOR: Black
 MATERIAL: PA6 10% GF & 20% GB
 TERMINALS: See Page 18
 SEALS/PLUGS: See Page 18

PART NO: 15336027
 DESCRIPTION: TBI Connector Assembly 2F
 SIZE: 26.0L x 11.0H x 20.5W
 COLOR: Black
 MATERIAL: PA6 10% GF & 20% GB
 TERMINALS: See Page 18
 SEALS/PLUGS: See Page 18
 NOTE: Mates to Throttle Body Injector.

PART NO: 15336029
 DESCRIPTION: Connector Assembly 3F
 SIZE: 26.0L x 18.5H x 20.5W
 COLOR: Black
 MATERIAL: PA6 10% GF & 20% GB
 TERMINALS: See Page 18
 SEALS/PLUGS: See Page 18

PART NO: 15354716
 DESCRIPTION: Connector Assembly 4F
 SIZE: 26.0L x 18.5H x 24.0W
 COLOR: Black
 MATERIAL: PA6 10% GF & 20% GB
 TERMINALS: See Page 18
 SEALS/PLUGS: See Page 18

GT CONNECTOR ASSEMBLY/METRI-PACK PULL-TO-SEAT REPLACEMENT CROSS REFERENCE

GT Connector Assembly	Description	Metri-Pack Pull-To-Seat
15336024	Connector Assembly 2F	12162193, 12162194, 12162195
15336027 TBI	Connector Assembly 2F	12162204, 12162206, 12162208, 12162215, 12162216, 12162217, 12162218
15336029	Connector Assembly 3F	12162182, 12162183, 12162184, 12162185, 12162186
15336035	Connector Assembly 4F	12124846, 12129192, 12162188, 12162189, 12162190, 12162191

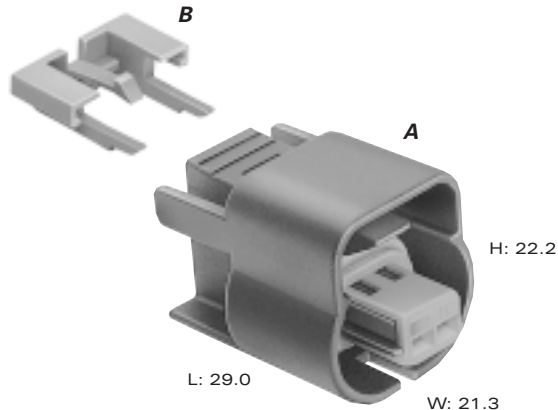

**Shrouded Female
Mushroom Indexed**

A PART NO: 15336004*
DESCRIPTION: Connector Assembly 2F
SIZE: 29.0L x 22.2H x 21.3W
COLOR: Black
MATERIAL: PA6 10% GF & 20% GB
TERMINALS: See Page 18
SEALS/PLUGS: See Page 18
*See Page 19 for alternative material

PART NO: 15326389*
DESCRIPTION: Connector Assembly 5F
SIZE: 29.0L x 22.2H x 31.8W
COLOR: Black
MATERIAL: PA66 HS IM
TERMINALS: See Page 18
SEALS/PLUGS: See Page 18
*See Page 19 for alternative material

PART NO: 15336121*
DESCRIPTION: Connector Assembly 3F
SIZE: 29.0L x 22.2H x 24.8W
COLOR: Black
MATERIAL: PA66 HS IM
TERMINALS: See Page 18
SEALS/PLUGS: See Page 18
*See Page 19 for alternative material

PART NO: 15336013*
DESCRIPTION: Connector Assembly 6F
SIZE: 29.0L x 22.2H x 35.3W
COLOR: Black
MATERIAL: PA66 HS IM
TERMINALS: See Page 18
SEALS/PLUGS: See Page 18
*See Page 19 for alternative material

PART NO: 15355331*
DESCRIPTION: Connector Assembly 4F
SIZE: 29.0L x 22.2H x 28.3W
COLOR: Black
MATERIAL: PA66 HS IM
TERMINALS: See Page 18
SEALS/PLUGS: See Page 18
*See Page 19 for alternative material

B PART NO: 15317832
DESCRIPTION: CPA
COLOR: Gray
MATERIAL: PA6 10% GF & 20% GB

**GT CONNECTOR ASSEMBLY/METRI-PACK SlimLine
CROSS REFERENCE**

GT Connector Assembly	Description	Metri-Pack Pull-To-Seat
15336004, 15355317	Connector Assembly 2F	12162193, 12162194, 12162195
15336121, 15355323	Connector Assembly 3F	12162182, 12162183, 12162184, 12162185, 12162186
15326559, 15355331	Connector Assembly 4F	12124846, 12129192, 12162188, 12162189, 12162190, 12162191
15326389, 15355268	Connector Assembly 5F	12162825, 12162826, 12162827
15336013, 15326829	Connector Assembly 6F	12066317, 12162210, 12162260, 12162261, 12162262