

# Altech Corp.®

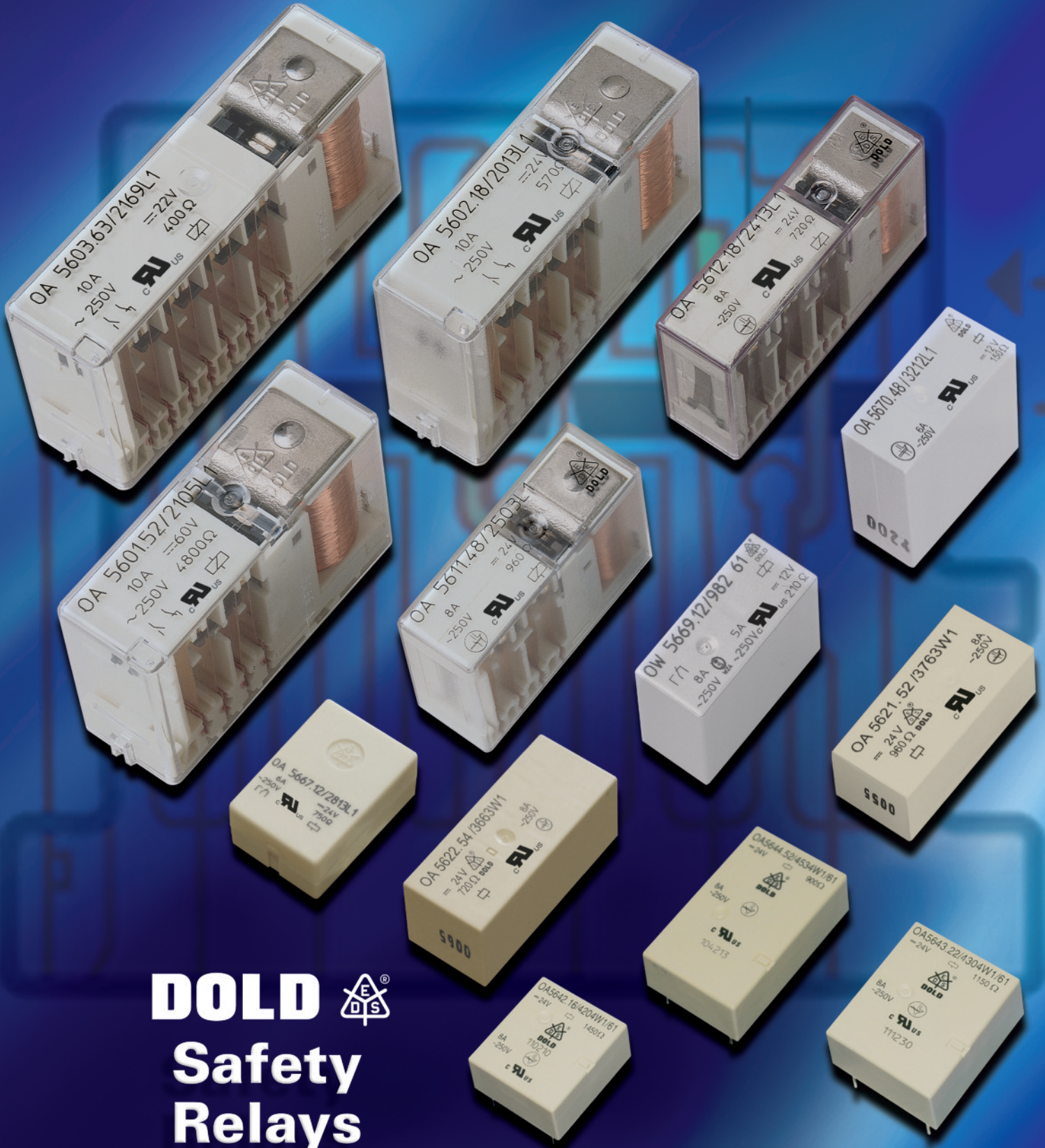

ISO 9001  
OMI-SAI Global

Serving the Automation & Control Industry since 1984



**DOLD**   
**Safety  
Relays**

# Altech Corp.®

Since 1984, Altech Corporation has grown to become a leading supplier of automation and industrial control components. Headquartered in Flemington, NJ, Altech has an experienced staff of engineering, manufacturing and sales personnel to provide the highest quality products with superior service. This is the Altech Commitment!

Altech's line of safety relays are manufactured by **DOLD** ⚡, a company well known in Europe for its quality safety relays. The products presented in this catalog will help you meet requirements of Machinery Directive 2006/42/EC, important international safety standards, CE-marking demand, and more, when exporting your machinery or equipment.

## What is a Safety Relay?

A safety relay contains force guided contacts; they are also known as captive, locked or positive guided contacts. Force guidance in a relay means that the contacts in a contact set must be mechanically linked together so that it is impossible for the NO (normally open) and NC (normally closed) contacts to be closed at the same time. The contacts are linked so that no one contact in a relay can change state without changing all the contacts in that relay. There must be a 0.5 mm minimum air gap between the open contacts for the entire service life of the relay, even in the case of a failure. The force guidance of the relay contacts must always be preserved even when a relay part fails to function correctly.

Our technical experts welcome the opportunity to answer your technical questions and provide solutions to your automation and control problems. Give us a call or visit [www.altechcorp.com](http://www.altechcorp.com).



## Quality Commitment

*Altech's control components meet diverse national and international standards such as UL, NEC, CSA, IEC, VDE and more. Altech provides superior customer service and delivery through Total Quality Management and Continuous Process Improvement. Altech is ISO 9001 approved. We perform these services with honesty and integrity and are committed to achieve these goals.*





**OA 5642/43/44**  
1 NO/1 NC, 2NO/1NC,  
2NO/2NC, 3NO/1NC  
Page 4-5

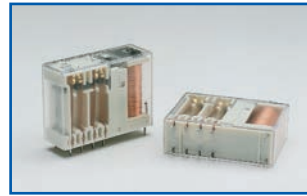

**OA 5611**  
2 NO/2 NC, 3 NO/1 NC  
Page 16-17

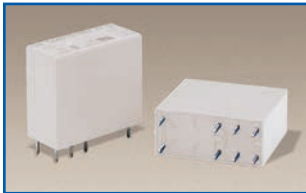

**OA/OW 5669**  
1 NO/1 NC, 2 CO, 2 NO, 2 NC  
Page 6-7

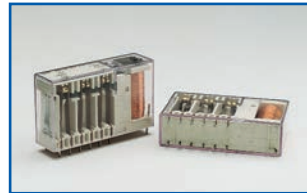

**OA 5612**  
2 NO/4 NC, 3 NO/3 NC, 4 NO/2 NC  
Page 18-19



**OA/OW 5670**  
2 NO/2 NC, 3 NO/1 NC  
Page 8-9

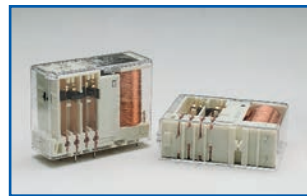

**OA 5601**  
2 NO/2 NC, 3 NO/1 NC  
Page 20-21



**OA 5621 / OA 5621S**  
3 NO/1 NC, 2 NO/2 NC  
Page 10-11



**OA 5602**  
2 NO/4 NC, 3 NO/3 NC, 4 NO/2 NC  
Page 22-23



**OA 5622 / OA 5622S**  
2 NO/4 NC, 3 NO/3 NC,  
4 NO/2 NC, 5 NO/1 NC  
Page 12-13



**OA 5603**  
7 NO/1 NC, 6 NO/2 NC, 5 NO/3 NC,  
4 NO/4 NC, 3 NO/5 NC, 2 NO/6 NC  
Page 24-25

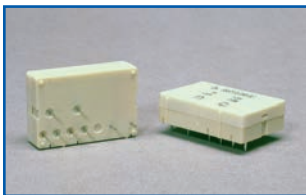

**OA 5667 / OA 5667S**  
1 NO/1 NC, 2 CO  
Page 14-15

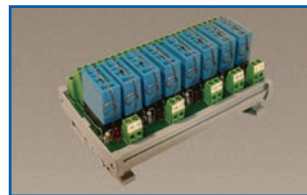

Safety Relay Modules  
Bused Channel  
Isolated Channel  
Page 26-31



Accessories ..... Page 32  
Applications ..... Page 33  
Terminology ..... Page 34-36  
Index..... Page 37  
Terms & Conditions ..... Page 38

# Safety Relay

## OA 5642/43/44

### Features

- 2-4 output contacts
- International approvals: TÜV, UL, cUL
- Quality control check for each safety relay
- Forced-guided contacts, all gold flash plated
- Contact Gap > 0.5 mm throughout life of relay
- Various contact materials, mixed contact material optional
- High coil voltage range
- High switching voltage
- High breakdown voltage: contact/coil  $\geq$  4 KV  
contact/contact  $\geq$  4KV
- High creeping distance: contact/coil  $\geq$  5.5 mm  
contact/contact  $\geq$  5.5 mm
- Protection Rating IP67, washable
- Compact size- only 10.3 mm height
- SMD component can be mounted under relay
- Custom design available,
  - coil voltage
  - operate/release time
  - contact pressure
  - coil resistance

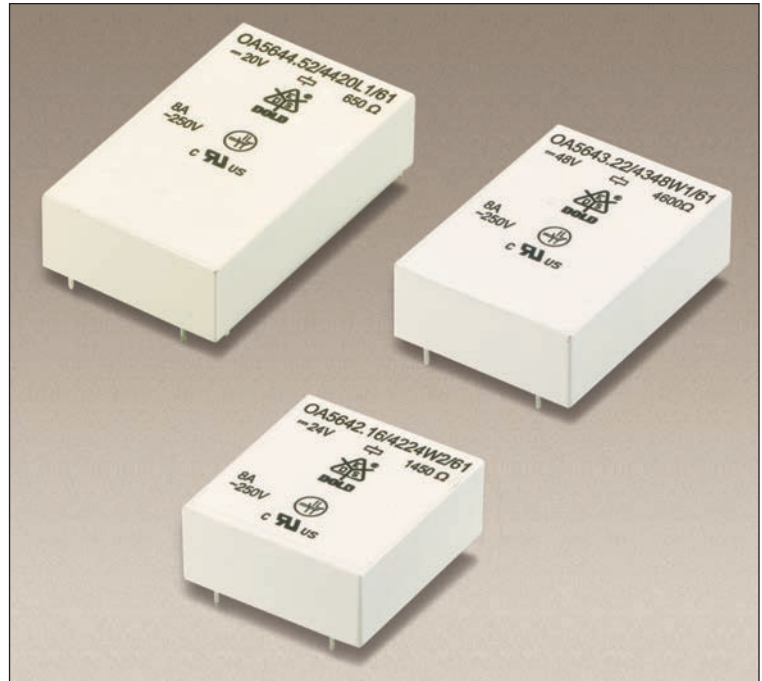

### Technical Data

- **Nominal Coil Voltage** .....6, 12, 21, 24, 48, 60, 110, DC
- **Coil Power Dissipation** .....0.4/0.5/0.65 W
- **Max. Switching Voltage** .....250V DC, 400 V AC
- **Max. Switching Current** .....8 A
- **Max. Switching Power — DC**.....240W
- **Max. Switching Power — AC**.....2000VA
- **Contact Switching Rate** .....20 operations per second
- **Relay Operate Time** ..... $\leq$  15 ms
- **Relay Release Time** ..... $\leq$  5 ms
- **Operation Vibration** .....0.5 mm Ampl. max  
.....@ 10...100Hz, 3g max
- **Protection Rating** .....IP 67
- **Contact Arrangements**.....1NO/1NC, 2NO/1NC, 2NO/2NC, 3NO/1NC,
- **Contact Material**.....AgNi10+0.2 $\mu$ mAu, AgSnO<sub>2</sub>+0.2 $\mu$ mAu, AgNi10+5 $\mu$ mAu
- **Mechanical Life** .....>40x10<sup>6</sup> operation cycles
- **Electrical Life** .....>50,000  
.....operation cycles @ 230V AC, 8A, cos  $\varphi$ =1
- **Ambient Temperature**.....-40...+85°C
- **Cover Material**.....Thermoplast
- **Weight**.....14/15/16 g
- More detailed data upon request

### Diagrams



Relay operation voltage vs. ambient temperature

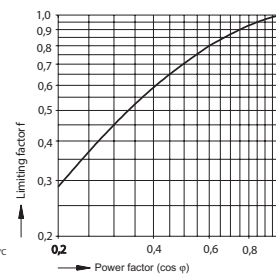
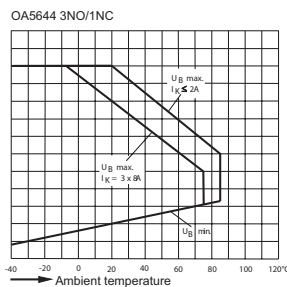
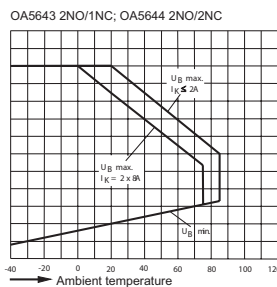

Operations =  
Operations (ohmic) x  
limitation factor F

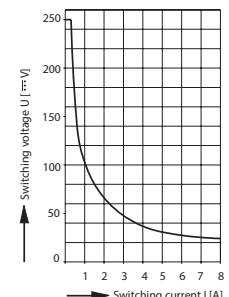

Maximum switching power curve

Limitation factor for inductive loads

# Safety Relay OA 5642/43/44 Data

## Relay Data

## Ordering Information

| Rated Voltage | Voltage Range | Coil Resistance (10%) | 1 NO/1 NC Type | Coil Resistance (10%) | 2NO/1NC Type  | Coil Resistance (10%) | 3NO/1NC Type  | 2NO/2NC Type  |
|---------------|---------------|-----------------------|----------------|-----------------------|---------------|-----------------------|---------------|---------------|
| 6V            | 4.2 - 7.8V    | 90 Ω                  | 56.OA42.0611□  | 70 Ω                  | 56.OA43.0621□ | 55 Ω                  | 56.OA44.0631□ | 56.OA44.0622□ |
| 12V           | 8.4 - 15.2V   | 370 Ω                 | 56.OA42.1211□  | 290 Ω                 | 56.OA43.1221□ | 230 Ω                 | 56.OA44.1231□ | 56.OA44.1222□ |
| 21V           | 15.0 - 27.3V  | 1050 Ω                | 56.OA42.2111□  | 840 Ω                 | 56.OA43.2121□ | 680 Ω                 | 56.OA44.2131□ | 56.OA44.2122□ |
| 24V           | 16.8 - 31.2V  | 1450 Ω                | 56.OA42.2411□  | 1150 Ω                | 56.OA43.2421□ | 900 Ω                 | 56.OA44.2431□ | 56.OA44.2422□ |
| 48V           | 33.6 - 62.4V  | 6000 Ω                | 56.OA42.4811□  | 4600 Ω                | 56.OA43.4821□ | 3600 Ω                | 56.OA44.4831□ | 56.OA44.4822□ |
| 60V           | 42.0 - 78.0V  | 9250 Ω                | 56.OA42.6011□  | 7100 Ω                | 56.OA43.6021□ | 5600 Ω                | 56.OA44.6031□ | 56.OA44.6022□ |
| 110V          | 77.0 - 143.0V | 31000 Ω               | 56.OA42.1111□  | 24000 Ω               | 56.OA43.1121□ | 18500 Ω               | 56.OA44.1131□ | 56.OA44.1122□ |

Contact Material, Example: □ AgSnO<sub>2</sub>+2μmAu

□ AgNi10+.2μmAu

□ AgNi10+5μmAu

## Dimensions & Pin Configurations

### 5642

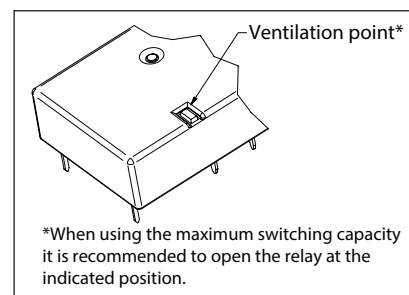
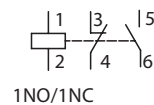
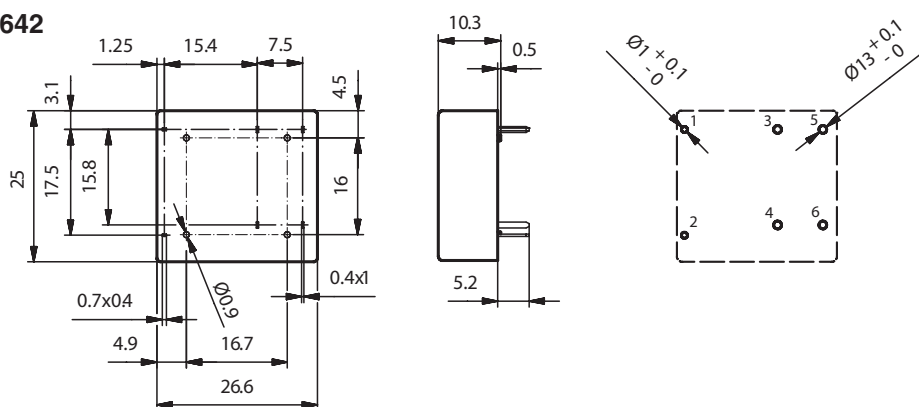

### 5643

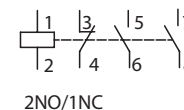
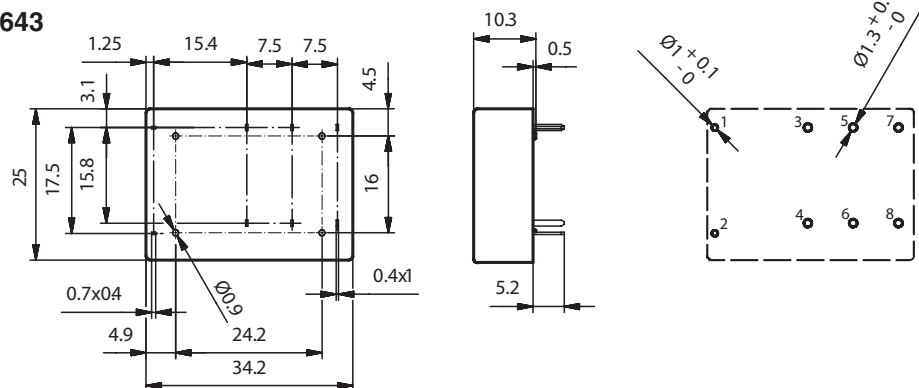

### 5644

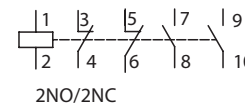
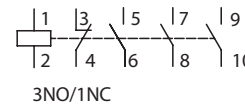
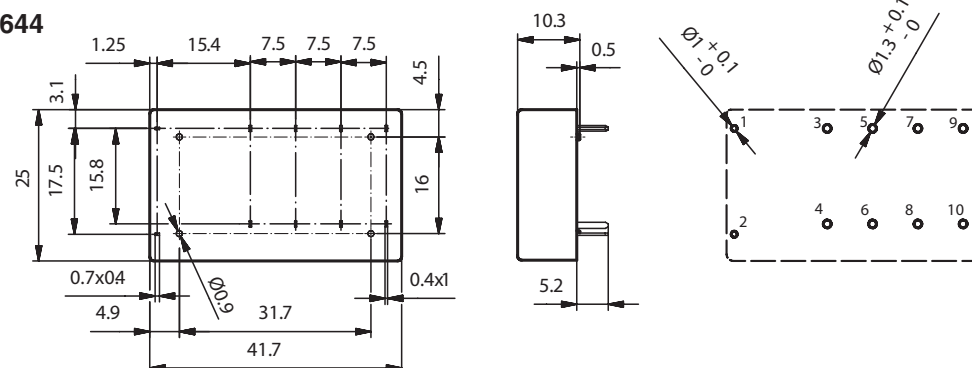

Note: All dimensions are shown in millimeters. To convert to inches, divide by 25.4.

# Safety Relay

## OA/OW 5669

### Features

- 2 output contacts
- International approvals: TÜV, UL, cUL
- Quality control check for each safety relay
- Forced-guided contacts, all gold flash plated
- Contact Gap > 0.5 mm throughout life of relay
- Various contact materials, mixed contact material optional
- High coil voltage range
- High breakdown voltage: contact/coil  $\geq$  4 KV  
contact/contact  $\geq$  4KV
- High creeping distance: contact/coil  $\geq$  8 mm  
contact/contact  $\geq$  5.5 mm
- Protection Rating  
OA Version: IP 40, flow solder proof  
OW Version: IP 67, washable
- Custom design available,  
-coil voltage                      -coil resistance,  
-contact pressure                -operate/release time

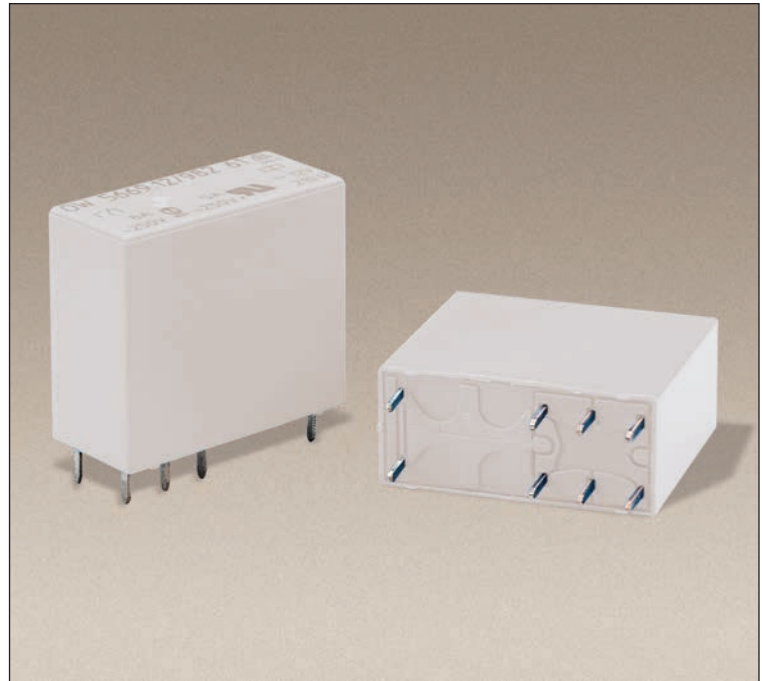

### Technical Data

- **Nominal Coil Voltage** ..... 6, 12, 20, 24, 48, 60, 110, DC
- **Coil Power Dissipation** ..... 0.7 W
- **Max. Switching Voltage** ..... 250V DC, 400V AC
- **Max. Switching Current** ..... 8 A (2 x 5A simultaneous)
- **Max. Switching Power — DC** ..... 200W (2 x 160W simultaneous)
- **Max. Switching Power — AC** ..... 2000VA (2 x 1250VA simultaneous)
- **Contact Switching Rate** ..... 10 operations per second
- **Relay Operate Time** .....  $\leq$  15 ms
- **Relay Release Time** .....  $\leq$  12 ms
- **Operation Vibration** ..... 0.35 mm Ampl. max  
@ 10...55Hz, 5g max
- **Contact Arrangements** ..... 1NO/1NC, 2CO, 2NO\*, 2NC\*
- **Contact Material** ..... AgNi10+0.2 $\mu$ mAu Standard  
AgSnO<sub>2</sub>+0.2 $\mu$ mAu, AgNi10+5 $\mu$ mAu Optional
- **Mechanical Life** .....  $\geq$  50x10<sup>6</sup> operation cycles
- **Electrical Life** ..... AgSnO<sub>2</sub> >2x10<sup>5</sup>, AgNi10 >10<sup>5</sup>  
operation cycles @ 230V AC, 6A, cos  $\varphi$ =1
- **Ambient Temperature** ..... -40...+70°C
- **Cover Material** ..... Polyamide 6
- **Weight** ..... 15 g
- More detailed data upon request

### Diagrams



Relay operation voltage vs. ambient temperature

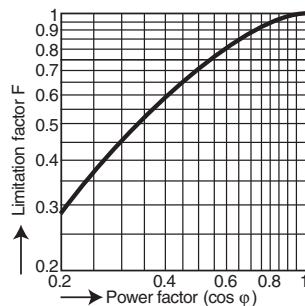

Operations =  
Operations (ohmic) x limitation factor F

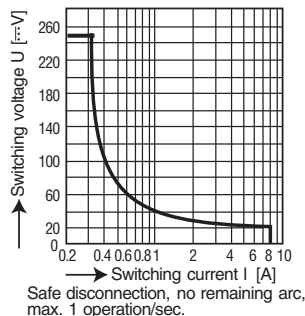

Maximum switching power curve

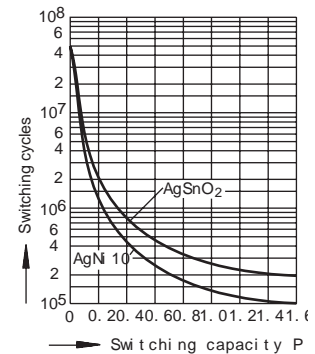

Mechanical life

\*Special order.

# Safety Relay OA/OW 5669 Data

## Relay Data

## Ordering Information

| Rated Voltage | Voltage Range | Coil Resistance (10%) | 1 NO/1 NC Type | 2 CO Type     | 2 NO* Type    | 2 NC* Type    |
|---------------|---------------|-----------------------|----------------|---------------|---------------|---------------|
| 6V            | 4.8 - 9.6V    | 50 Ω                  | 56.O□69.0611□  | 56.O□69.0600□ | 56.O□69.0620□ | 56.O□69.0602□ |
| 10V           | 8.0 - 16.0V   | 150 Ω                 | 56.O□69.1011□  | 56.O□69.1000□ | 56.O□69.1020□ | 56.O□69.1002□ |
| 12V           | 9.6 - 19.2V   | 210 Ω                 | 56.O□69.1211□  | 56.O□69.1200□ | 56.O□69.1220□ | 56.O□69.1202□ |
| 20V           | 16.0 - 32.0V  | 580 Ω                 | 56.O□69.2011□  | 56.O□69.2000□ | 56.O□69.2020□ | 56.O□69.2002□ |
| 24V           | 19.2 - 38.4V  | 820 Ω                 | 56.O□69.2411□  | 56.O□69.2400□ | 56.O□69.2420□ | 56.O□69.2402□ |
| 48V           | 38.4 - 76.8V  | 3200 Ω                | 56.O□69.4811□  | 56.O□69.4800□ | 56.O□69.4820□ | 56.O□69.4802□ |
| 60V           | 48.0 - 96.0V  | 5200 Ω                | 56.O□69.6011□  | 56.O□69.6000□ | 56.O□69.6020□ | 56.O□69.6002□ |
| 110V          | 88.0 - 176.0V | 18000 Ω               | 56.O□69.1111□  | 56.O□69.1100□ | 56.O□69.1120□ | 56.O□69.1102□ |

Protection Class, Example:

- A** IP 40, Flow Solder Proof
- W** IP 67, Washable

Contact Material, Example:

- C** AgSnO<sub>2</sub>+2μmAu
- N** AgNi10+2μmAu
- S** AgNi0.15+5μmAu

## Footprints (solder side)

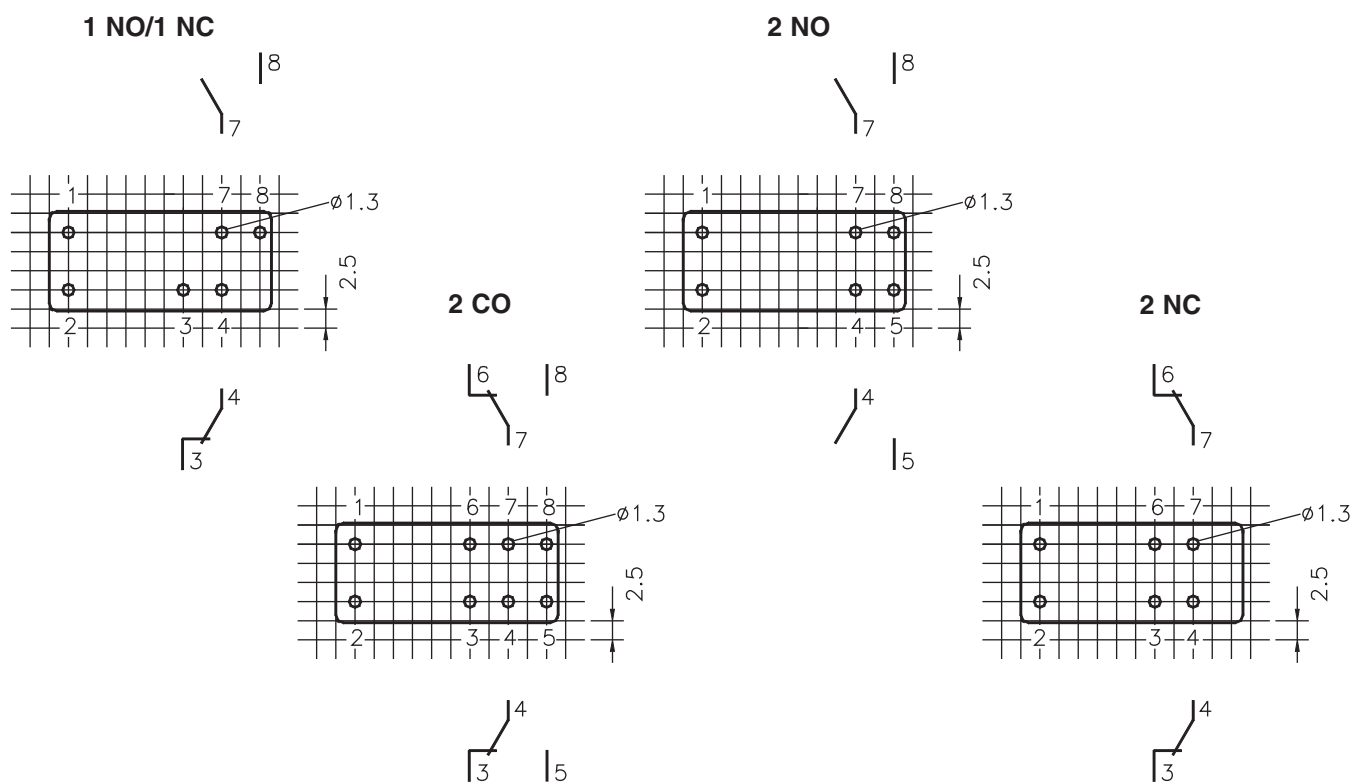

## Dimensions



Note: All dimensions are shown in millimeters. To convert to inches, divide by 25.4.

\*Special order.

# Safety Relay

## OA/OW 5670

### Features

- 4 output contacts
- International approvals: TÜV, UL, cUL
- Quality control check for each safety relay
- Forced-guided contacts, all gold flash plated
- Contact Gap > 0.5 mm throughout life of relay
- Various contact materials, mixed contact material optional
- High coil voltage range
- High breakdown voltage: contact/coil  $\geq$  4 KV  
contact/contact  $\geq$  3KV
- High creeping distance: contact/coil  $\geq$  8 mm  
contact/contact  $\geq$  4.5 mm
- Protection Rating  
OA Version: IP 40, flow solder proof  
OW Version: IP 67, washable
- Custom design available,  
-coil voltage                      -coil resistance,  
-contact pressure                -operate/release time



### Technical Data

- **Nominal Coil Voltage** .....6, 12, 20, 24, 48, 60, 110, DC
- **Coil Power Dissipation** .....1.0 W
- **Max. Switching Voltage** .....250V DC, 400V AC
- **Max. Switching Current** .....6 A (3 x 6A simultaneous)
- **Max. Switching Power — DC**.....160W
- **Max. Switching Power — AC**.....1500VA
- **Contact Switching Rate** .....10 operations per second
- **Relay Operate Time** .....11 ms
- **Relay Release Time** .....6 ms
- **Operation Vibration** .....0.35 mm Ampl. max  
.....@ 10...200Hz, 5g max
- **Contact Arrangements**.....2NO/2NC, 3NO/1NC
- **Contact Material**.....AgNi10+0.2 $\mu$ mAu Standard  
.....AgSnO<sub>2</sub>+0.2 $\mu$ mAu, AgNi10+5 $\mu$ mAu Optional
- **Mechanical Life**..... $\geq$ 50x10<sup>6</sup> operation cycles
- **Electrical Life** .....AgSnO<sub>2</sub> >2x10<sup>5</sup>, AgNi10 >1.2x10<sup>5</sup>  
.....operation cycles @ 230V AC, 6A, cos  $\varphi$ =1
- **Ambient Temperature**.....-40...+75°C
- **Cover Material** .....Polyamide 6
- **Weight**.....20 g
- More detailed data upon request

### Diagrams

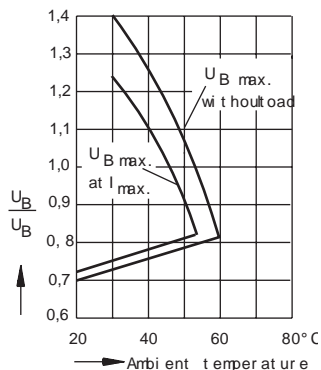

Relay operation voltage vs. ambient temperature

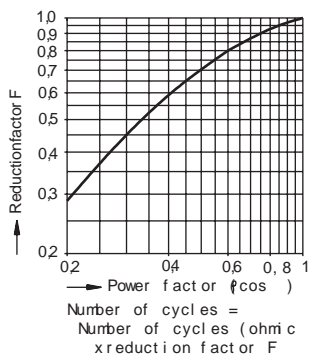

Limitation factor for inductive loads

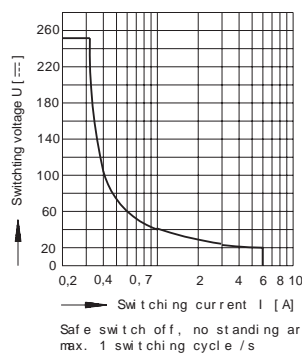

Maximum switching power curve

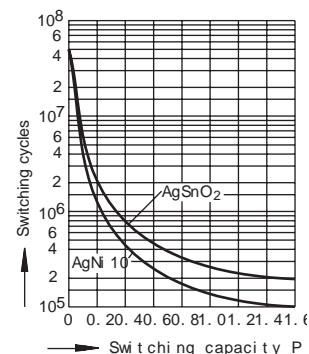

Mechanical life



# Safety Relay OA/OW 5670 Data

| Relay Data    |               |                       | Ordering Information |                |
|---------------|---------------|-----------------------|----------------------|----------------|
| Rated Voltage | Voltage Range | Coil Resistance (10%) | 2 NO/2 NC Type       | 3 NO/1 NC Type |
| 6V            | 4.2 - 8.4V    | 36 Ω                  | 56.O□70.0622□        | 56.O□70.0631□  |
| 12V           | 8.4 - 16.8V   | 150 Ω                 | 56.O□70.1222□        | 56.O□70.1231□  |
| 20V           | 14.0 - 28.0V  | 400 Ω                 | 56.O□70.2022□        | 56.O□70.2031□  |
| 24V           | 16.8 - 33.6V  | 580 Ω                 | 56.O□70.2422□        | 56.O□70.2431□  |
| 48V           | 33.6 - 67.2V  | 2300 Ω                | 56.O□70.4822□        | 56.O□70.4831□  |
| 60V           | 42.0 - 84.0V  | 3600 Ω                | 56.O□70.6022□        | 56.O□70.6031□  |
| 110V          | 77.0 - 154.0V | 12100 Ω               | 56.O□70.1122□        | 56.O□70.1131□  |

Protection Class, Example:

- A IP 40, Flow Solder Proof
- W IP 67, Washable

Contact Material, Example:

- C AgSnO<sub>2</sub>+2μmAu
- N AgNi10+.2μmAu
- S AgNi0.15+5μmAu

## Footprints (solder side)

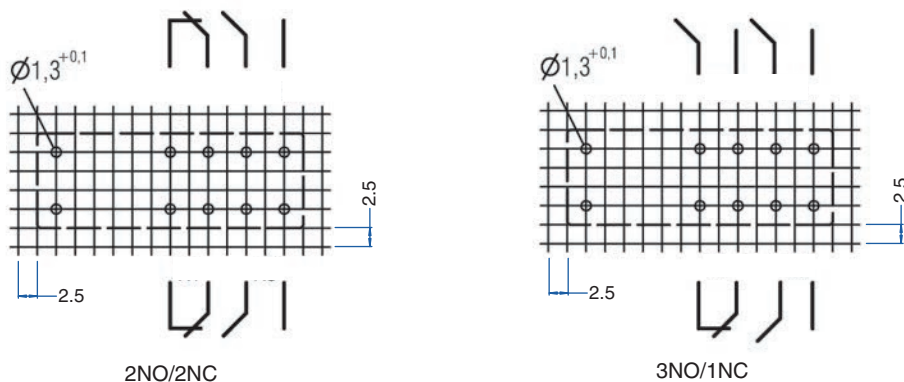

## Dimensions

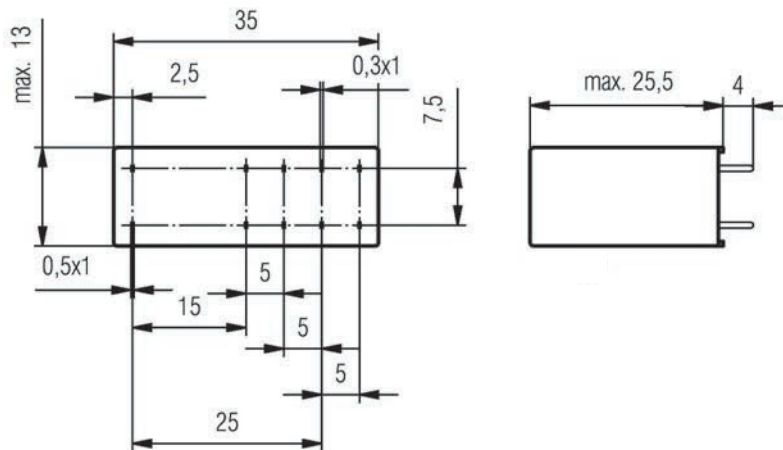

Note: All dimensions are shown in millimeters. To convert to inches, divide by 25.4.

# Safety Relay

## OA 5621 / OA 5621S

### Features

- 4 output contacts
- International approvals: TÜV, UL, cUL
- Quality control check for each safety relay
- Forced-guided contacts, all gold flash plated
- Contact Gap > 0.5 mm throughout life of relay
- Various contact materials, mixed contact material optional
- High coil voltage range
- High breakdown voltage: contact/coil  $\geq$  4 KV  
contact/contact  $\geq$  4KV
- High creeping distance: contact/coil  $\geq$  5.5 mm  
contact/contact  $\geq$  5.5 mm
- Protection Rating IP 67, washable
- Custom design available,
  - coil voltage
  - coil resistance,
  - contact pressure
  - operate/release time
  - gold plated double contacts
- S-Type  
higher external clearance and creeping distance:  
contact/contact  $\geq$  7.5 mm



### Technical Data

- **Nominal Coil Voltage** .....6, 12, 24, 48, 60, 110, DC
- **Coil Power Dissipation** .....0.6 W
- **Max. Switching Voltage** .....250V DC, 400V AC
- **Max. Switching Current** .....8 A (3 x 8A simultaneous)
- **Max. Switching Power — DC** .....200W
- **Max. Switching Power — AC** .....2000VA
- **Contact Switching Rate** .....10 operations per second
- **Relay Operate Time** .....12 ms
- **Relay Release Time** .....8 ms
- **Operation Vibration** .....0.35 mm Ampl. max  
.....@ 10...200Hz, 5g max
- **Contact Arrangements** .....3NO/1NC, 2NO/2NC
- **Contact Material** .....AgNi10+0.2 $\mu$ mAu Standard  
.....AgSnO<sub>2</sub>+0.2 $\mu$ mAu, AgNi10+5 $\mu$ mAu Optional
- **Mechanical Life** .....>20x10<sup>6</sup> operation cycles
- **Electrical Life** .....AgSnO<sub>2</sub> >1.5x10<sup>5</sup>, AgNi10 >1.0x10<sup>5</sup>  
.....operation cycles @ 230V AC, 8A, cos  $\varphi$ =1
- **Ambient Temperature** .....-40...+80°C
- **Cover Material** .....Polyamide 6
- **Weight** .....35 g
- More detailed data upon request

### Diagrams



Relay operation voltage vs. ambient temperature

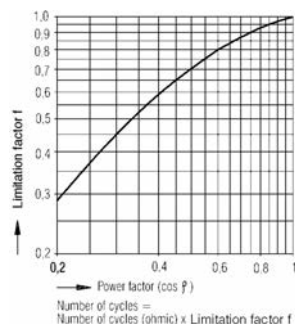

Limitation factor for inductive loads

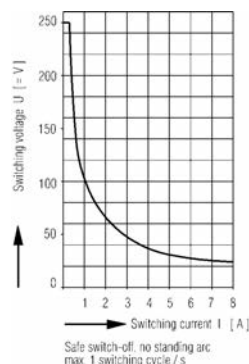

Maximum switching power curve

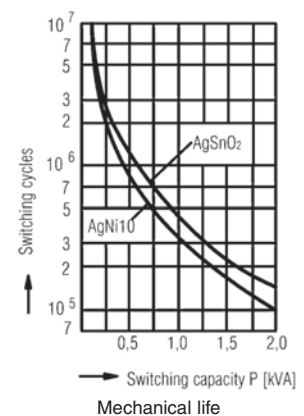

Mechanical life

# Safety Relay OA 5621 / OA 5621S Data

| Relay Data    |               |                       | Ordering Information |                |                  |                  |
|---------------|---------------|-----------------------|----------------------|----------------|------------------|------------------|
| Rated Voltage | Voltage Range | Coil Resistance (10%) | 3 NO/1 NC Type       | 2 NO/2 NC Type | 3 NO/1 NC S-Type | 2 NO/2 NC S-Type |
| 6V            | 4.5 - 8.4V    | 60 Ω                  | 56.OA21.0631□        | 56.OA21.0622□  | 56.OA21S.0631□   | 56.OA21S.0622□   |
| 12V           | 9.0 - 16.8V   | 240 Ω                 | 56.OA21.1231□        | 56.OA21.1222□  | 56.OA21S.1231□   | 56.OA21S.1222□   |
| 24V           | 18.0 - 33.6V  | 960 Ω                 | 56.OA21.2431□        | 56.OA21.2422□  | 56.OA21S.2431□   | 56.OA21S.2422□   |
| 48V           | 36.0 - 67.2V  | 3840 Ω                | 56.OA21.4831□        | 56.OA21.4822□  | 56.OA21S.4831□   | 56.OA21S.4822□   |
| 60V           | 45.0 - 84.0V  | 6000 Ω                | 56.OA21.6031□        | 56.OA21.6022□  | 56.OA21S.6031□   | 56.OA21S.6022□   |
| 110V          | 82.5 - 154.0V | 20000 Ω               | 56.OA21.1131□        | 56.OA21.1122□  | 56.OA21S.1131□   | 56.OA21S.1122□   |

Contact Material, Example: CAgSnO<sub>2</sub>+2μmAu  
NAgNi10+.2μmAu  
SAgNi10+5μmAu

## Footprints (solder side)

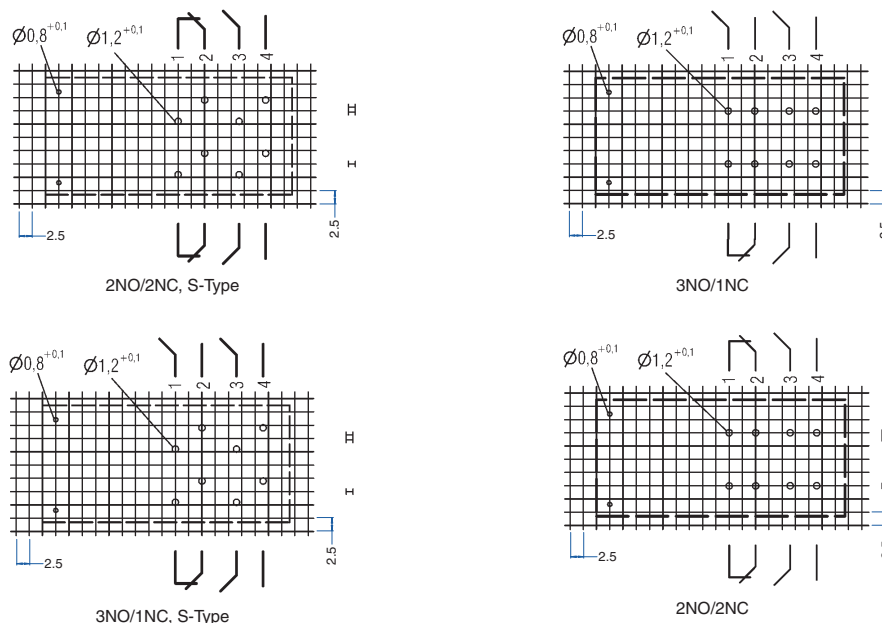

## Dimensions



Note: All dimensions are shown in millimeters. To convert to inches, divide by 25.4.

# Safety Relay

## OA 5622 / OA 5622S

### Features

- 6 output contacts
- International approvals: TÜV, UL, cUL
- Quality control check for each safety relay
- Forced-guided contacts, all gold flash plated
- Contact Gap > 0.5 mm throughout life of relay
- Various contact materials, mixed contact material optional
- High coil voltage range
- High breakdown voltage: contact/coil  $\geq$  4 KV  
contact/contact  $\geq$  4KV
- High creeping distance: contact/coil  $\geq$  5.5 mm  
contact/contact  $\geq$  5.5 mm
- Protection Rating IP 67, washable
- Custom design available,
  - coil voltage
  - coil resistance,
  - contact pressure
  - operate/release time
  - gold plated double contacts
- S-Type  
higher external clearance and creeping distance:  
contact/contact  $\geq$  7.5 mm



### Technical Data

- **Nominal Coil Voltage** .....6, 12, 24, 48, 60, 110, DC
- **Coil Power Dissipation** .....0.8 W
- **Max. Switching Voltage** .....250V DC, 400V AC
- **Max. Switching Current** .....8 A (5 x 8A simultaneous)
- **Max. Switching Power — DC** .....200W
- **Max. Switching Power — AC** .....2000VA
- **Contact Switching Rate** .....10 operations per second
- **Relay Operate Time** .....12 ms
- **Relay Release Time** .....8 ms
- **Operation Vibration** .....0.35 mm Ampl. max  
@ 10...200Hz, 5g max
- **Contact Arrangements** .....2NO/4NC, 3NO/3NC, 4NO/2NC, 5NO/1NC
- **Contact Material** .....AgNi10+0.2 $\mu$ mAu Standard  
.....AgSnO<sub>2</sub>+0.2 $\mu$ mAu, AgNi10+5 $\mu$ mAu Optional
- **Mechanical Life** .....>20x10<sup>6</sup> operation cycles
- **Electrical Life** .....AgSnO<sub>2</sub> >10<sup>5</sup>, AgNi10 >0.75x10<sup>5</sup>  
.....operation cycles @ 230V AC, 8A, cos  $\varphi$ =1
- **Ambient Temperature** .....-40...+80°C
- **Cover Material** .....Polyamide 6
- **Weight** .....38 g
- More detailed data upon request

### Diagrams

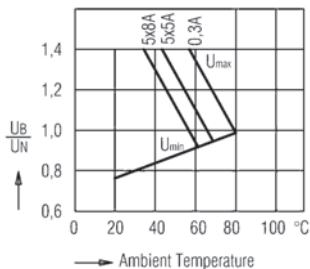

Relay operation voltage vs. ambient temperature

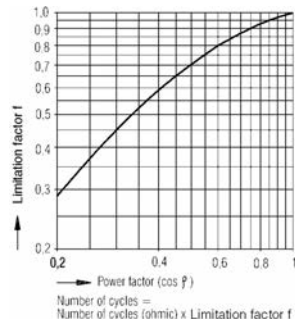

Limitation factor for inductive loads

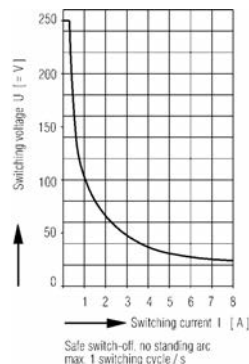

Maximum switching power curve

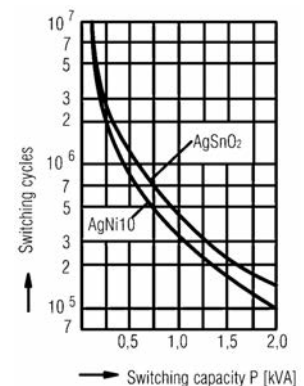

Mechanical life

# Safety Relay OA 5622 / OA 5622S Data

## Relay Data

## Ordering Information

| Rated Voltage | Voltage Range | Coil Resistance (10%) | 2 NO/4 NC Type | Coil Resistance (10%) | 3 NO/3 NC Type | 4 NO/2 NC Type | 5 NO/1 NC Type |
|---------------|---------------|-----------------------|----------------|-----------------------|----------------|----------------|----------------|
| 6V            | 4.5 - 8.4V    | 38 Ω                  | 56.OA22.0624□  | 45 Ω                  | 56.OA22.0633□  | 56.OA22.0642□  | 56.OA22.0651□  |
| 12V           | 9.0 - 16.8V   | 150 Ω                 | 56.OA22.1224□  | 180 Ω                 | 56.OA22.1233□  | 56.OA22.1242□  | 56.OA22.1251□  |
| 24V           | 18.0 - 33.6V  | 600 Ω                 | 56.OA22.2424□  | 720 Ω                 | 56.OA22.2433□  | 56.OA22.2442□  | 56.OA22.2451□  |
| 48V           | 36.0 - 67.2V  | 2400 Ω                | 56.OA22.4824□  | 2880 Ω                | 56.OA22.4833□  | 56.OA22.4842□  | 56.OA22.4851□  |
| 60V           | 45.0 - 84.0V  | 3800 Ω                | 56.OA22.6024□  | 4500 Ω                | 56.OA22.6033□  | 56.OA22.6042□  | 56.OA22.6051□  |
| 110V          | 82.5 -154.0V  | 12700 Ω               | 56.OA22.1124□  | 15125 Ω               | 56.OA22.1133□  | 56.OA22.1142□  | 56.OA22.1151□  |

For S-Type:

Please specify **S** when ordering:

Example: 56.OA22S. \_ \_ \_ □

Contact Material, Example: □ AgSnO<sub>2</sub>+2μmAu

□ AgNi10+.2μmAu

□ AgNi10+5μmAu

## Footprints (solder side)

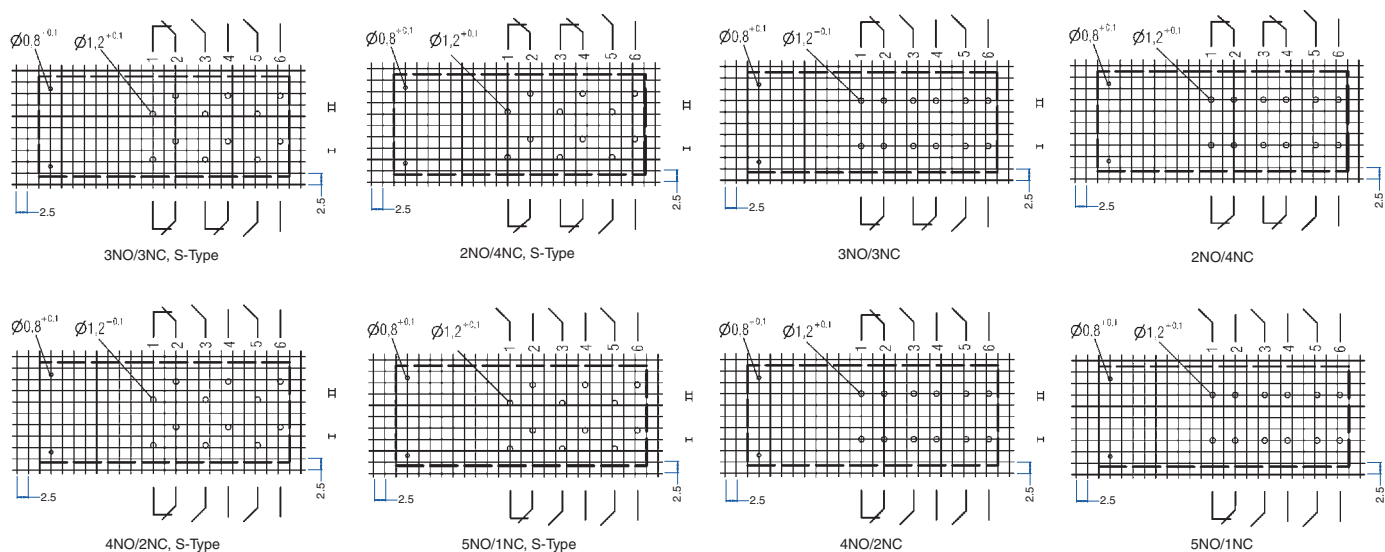

## Dimensions

### S-Type

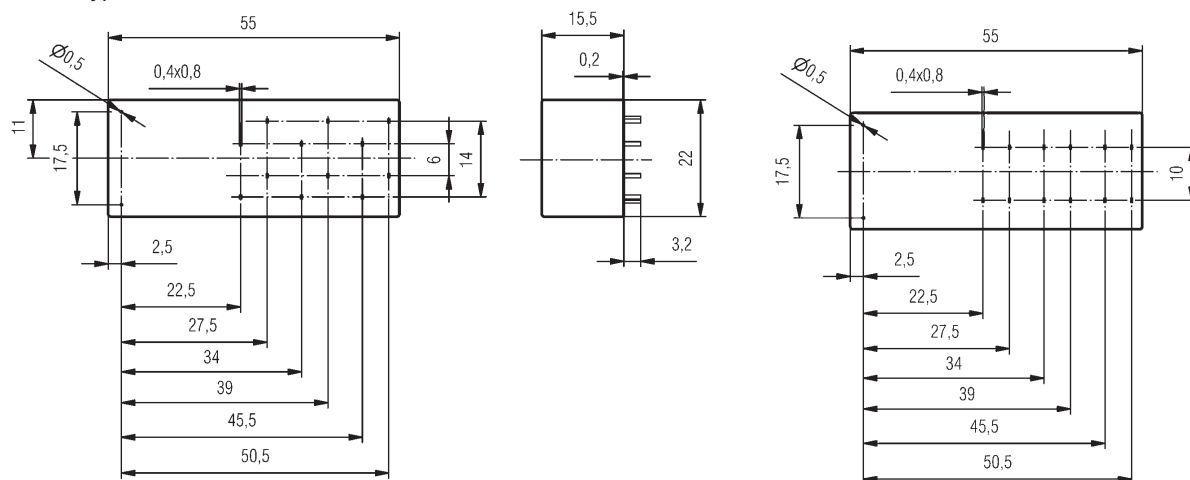

Note: All dimensions are shown in millimeters. To convert to inches, divide by 25.4.

# Safety Relay

## OA 5667 / OA 5667S

### Features

- 2 output contacts
- International approvals: TÜV, UL, cUL
- Quality control check for each safety relay
- Forced-guided contacts, all gold flash plated
- Contact Gap > 0.5 mm throughout life of relay
- Various contact materials, mixed contact material optional
- High coil voltage range
- High breakdown Voltage:
  - contact/coil  $\geq$  4 KV
  - contact/contact  $\geq$  2.5 KV
  - contact/contact  $\geq$  4 KV; S-Type
- High Creeping Distance:
  - contact/coil > 8 mm
  - contact/contact > 4.5 mm; S-Type 8.5 mm
- Custom design available,
  - coil voltage
  - coil resistance,
  - contact pressure
  - operate/release time

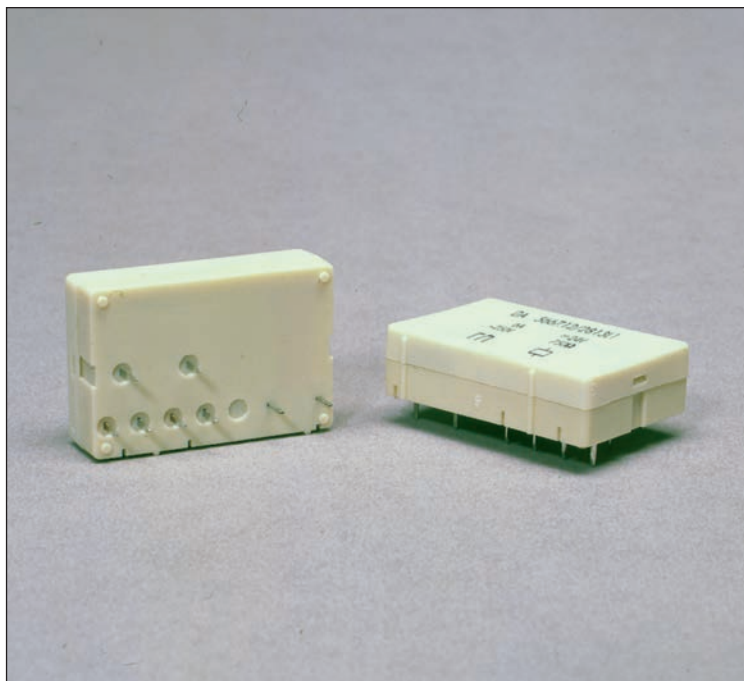

### Technical Data

- **Nominal Coil Voltage** .....6, 12, 24, 48, 60, 110 DC
- **Coil Power Dissipation** .....0.75 W
- **Max. Switching Voltage** .....250V DC, 400V AC
- **Max. Switching Current** .....6A (2 x 6A simultaneous)
- **Max. Switching Power — DC** .....200W (2 x 160W simultaneous)
- **Max. Switching Power — AC** .....1500VA (2 x 1500VA simultaneous)
- **Contact Switching Rate** .....10 operations per second
- **Relay Operate Time** .....10 ms
- **Relay Release Time** .....6 ms
- **Operation Vibration** .....0.35 mm Ampl. max @ 10...100Hz, 4g max
- **Contact Arrangements** .....1 NO/1 NC, 2CO
- **Contact Material** .....AgNi10+0.2 $\mu$ mAu Standard  
.....AgSnO<sub>2</sub>+0.2 $\mu$ mAu, AgNi10+5 $\mu$ mAu Optional
- **Mechanical Life** ..... $\geq 10^7$  operation cycles
- **Electrical Life** .....AgSnO<sub>2</sub> > 1.25x10<sup>5</sup>, AgNi10 > 10<sup>5</sup>  
.....operation cycles @ 230V AC, 5A, cos  $\varphi$ =1
- **Ambient Temperature** .....-40...+75°C
- **Protection Rating** .....IP40
- **Cover Material** .....Thermoplast
- **Weight** .....16 g
- More detailed data upon request

### Diagrams

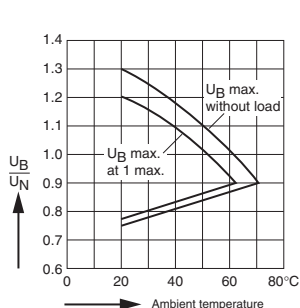

Relay operation voltage vs. ambient temperature

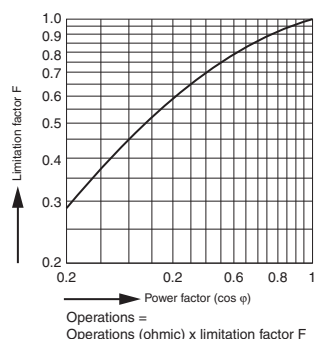

Limitation factor for inductive loads

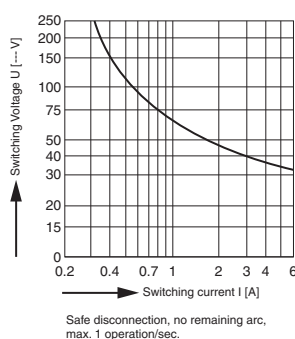

Maximum switching power curve

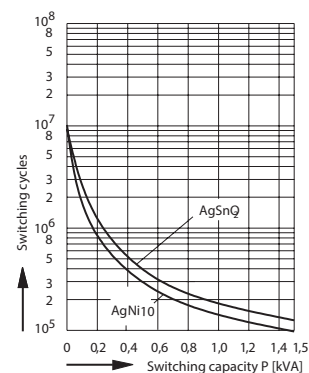

Mechanical life

# Safety Relay OA 5667/ OA 5667S Data

## Relay Data

## Ordering Information

| Rated Voltage | Voltage Range | Coil Resistance (10%) | 1 NO/1 NC Type | 2 CO Type     | 1 NO/1 NC S-Type | 2 CO S-Type    |
|---------------|---------------|-----------------------|----------------|---------------|------------------|----------------|
| 6V            | 4.5 - 7.8V    | 48 Ω                  | 56.OA67.0611□  | 56.OA67.0600□ | 56.OA67S.0611□   | 56.OA67S.0600□ |
| 12V           | 9.0 - 15.6V   | 183 Ω                 | 56.OA67.1211□  | 56.OA67.1200□ | 56.OA67S.1211□   | 56.OA67S.1200□ |
| 24V           | 18.0 - 31.2V  | 750 Ω                 | 56.OA67.2411□  | 56.OA67.2400□ | 56.OA67S.2411□   | 56.OA67S.2400□ |
| 48V           | 36.0 - 62.4V  | 3200 Ω                | 56.OA67.4811□  | 56.OA67.4800□ | 56.OA67S.4811□   | 56.OA67S.4800□ |
| 60V           | 45.0 - 78.0V  | 4700 Ω                | 56.OA67.6011□  | 56.OA67.6000□ | 56.OA67S.6011□   | 56.OA67S.6000□ |
| 110V          | 82.5 - 143.5V | 15300 Ω               | 56.OA67.1111□  | 56.OA67.1100□ | 56.OA67S.1111□   | 56.OA67S.1100□ |

Contact Material, Example: CAgSnO<sub>2</sub>+2μmAu  
NAgNi10+.2μmAu  
SAgNi10+5μmAu

## Footprints (solder side)

### 2 CO

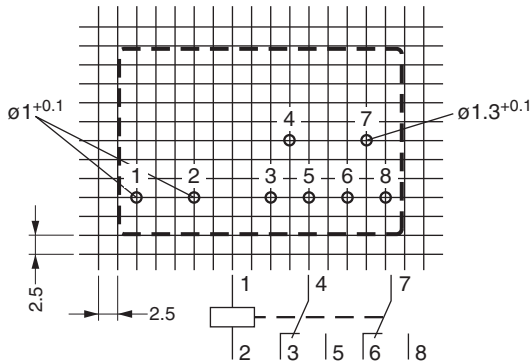

### 2 CO S-Type

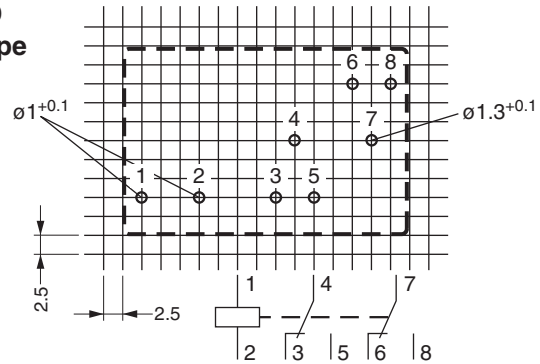

### 1 NO/1 NC

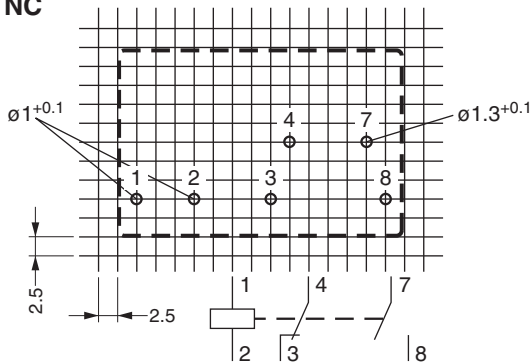

### 1 NO/1 NC S-Type

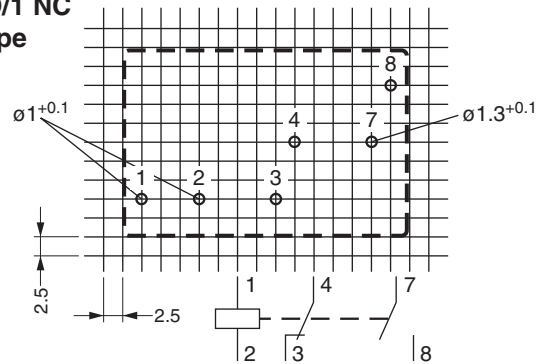

## Dimensions

### 2 CO

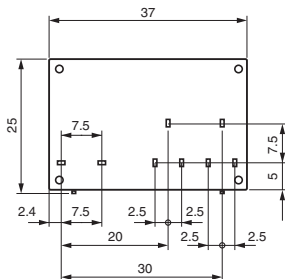

### 1 NO/1 NC

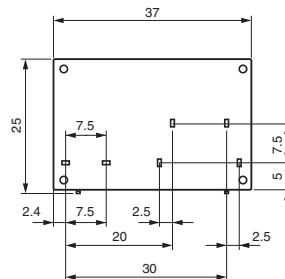

### 2 CO, S-Type

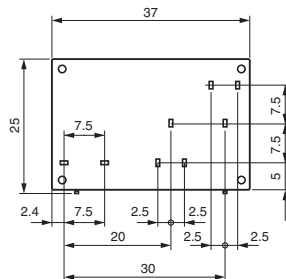

### 1 NO/1 NC, S-Type

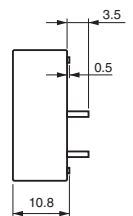
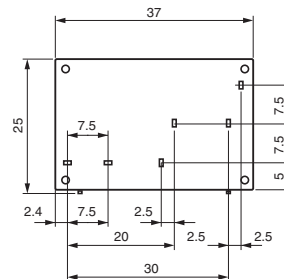

Note: All dimensions are shown in millimeters. To convert to inches, divide by 25.4.

# Safety Relay

## OA 5611

### Features

- 4 output contacts
- International approvals: TÜV, UL, cUL
- Quality control check for each safety relay
- Forced-guided contacts, all gold flash plated
- Contact Gap > 0.5 mm throughout life of relay
- Various contact materials, mixed contact material optional
- High coil voltage range
- High switching voltage
- High breakdown voltage: contact/coil  $\geq$  4 KV  
contact/contact  $\geq$  2.5KV
- High creeping distance: contact/coil  $\geq$  8 mm  
contact/contact  $\geq$  4.5 mm
- Crown contacts
- Solid connection between coil and contact housing
- Compact size
- Custom design available,
  - coil voltage -IP67 washable
  - contact pressure -coil resistance
  - operate/release time
  - low power dissipation models
  - Manual test relay (slide activated)



### Technical Data

- **Nominal Coil Voltage** .....6, 12, 24, 48, 60, 110, DC
- **Coil Power Dissipation** .....0.6 W
- **Max. Switching Voltage** .....250V DC, 400 V AC
- **Max. Switching Current** .....8 A
- **Max. Switching Power — DC**.....200W
- **Max. Switching Power — AC**.....2000VA
- **Contact Switching Rate** .....10 operations per second
- **Relay Operate Time** .....20 ms
- **Relay Release Time** .....6 ms
- **Operation Vibration** .....0.35 mm Ampl. max  
.....@ 10...200Hz, 3g max
- **Protection Rating** .....IP 40
- **Contact Arrangements**.....2NO/2NC, 3NO/1NC
- **Contact Material**.....AgNi10+0.2 $\mu$ mAu, AgSnO<sub>2</sub>+0.2 $\mu$ mAu, AgNi10+5 $\mu$ mAu
- **Mechanical Life**..... $\geq$ 50x10<sup>6</sup> operation cycles
- **Electrical Life** .....AgSnO<sub>2</sub> >1.5x10<sup>5</sup>, AgNi10 >10<sup>5</sup>  
.....operation cycles @ 230V AC, 8A, cos  $\varphi$ =1
- **Ambient Temperature**.....-40...+85°C
- **Cover Material**.....Thermoplast
- **Weight**.....35 g
- More detailed data upon request

### Diagrams

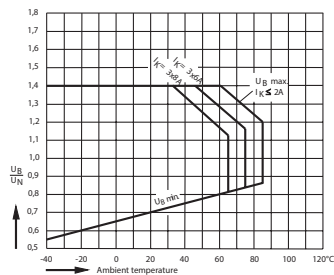

Relay operation voltage vs. ambient temperature

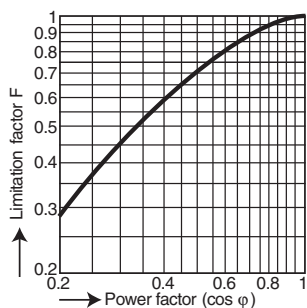

Operations =  
Operations (ohmic) x limitation factor F

Limitation factor for inductive loads

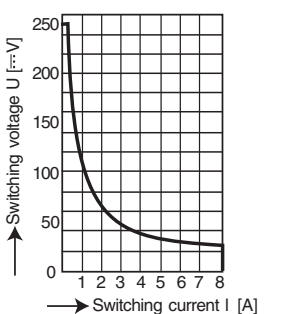

Safe disconnection, no remaining arc,  
max. 1 operation/sec.

Maximum switching power curve

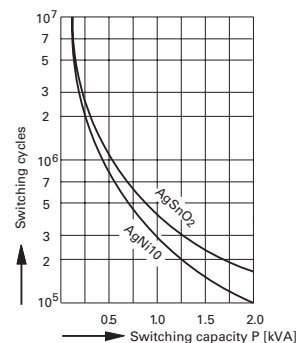

Mechanical life



# Safety Relay OA 5611 Data

| Relay Data    |               |                       | Ordering Information |                |
|---------------|---------------|-----------------------|----------------------|----------------|
| Rated Voltage | Voltage Range | Coil Resistance (10%) | 2 NO/2 NC Type       | 3 NO/1 NC Type |
| 6V            | 4.2 - 8.4V    | 56 Ω                  | 56.OA11.0622□        | 56.OA11.0631□  |
| 12V           | 8.4 - 16.8V   | 240 Ω                 | 56.OA11.1222□        | 56.OA11.1231□  |
| 24V           | 16.8 - 33.6V  | 960 Ω                 | 56.OA11.2422□        | 56.OA11.2431□  |
| 48V           | 33.6 - 67.2V  | 3840 Ω                | 56.OA11.4822□        | 56.OA11.4831□  |
| 60V           | 42.0 - 84.0V  | 6000 Ω                | 56.OA11.6022□        | 56.OA11.6031□  |
| 110V          | 77.0 - 154.0V | 20150 Ω               | 56.OA11.1122□        | 56.OA11.1131□  |

Contact Material, Example: □ AgSnO<sub>2</sub>+2μmAu  
 □ AgNi10+.2μmAu  
 □ AgNi10+5μmAu

## Footprints (solder side)

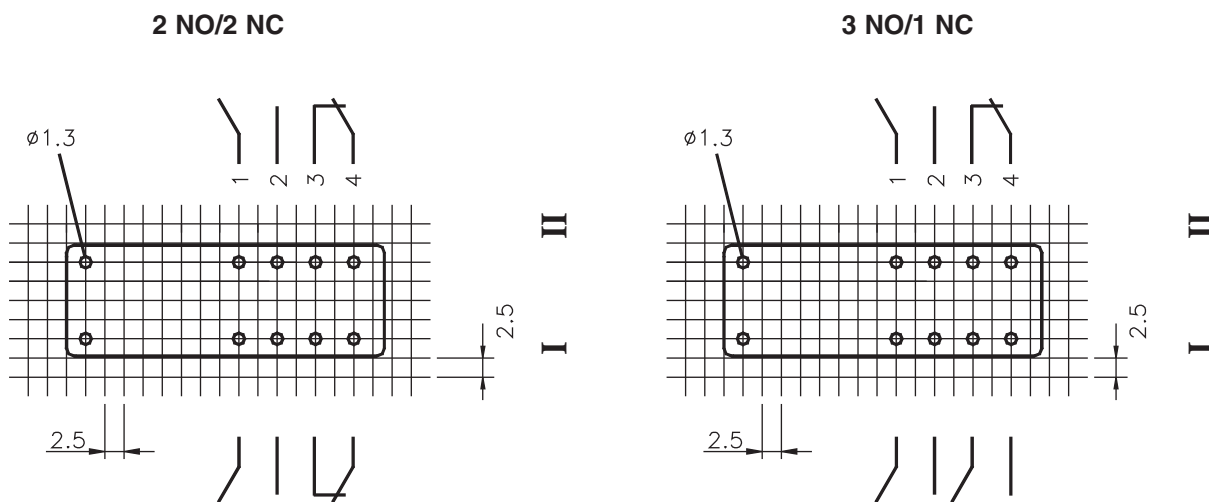

## Dimensions

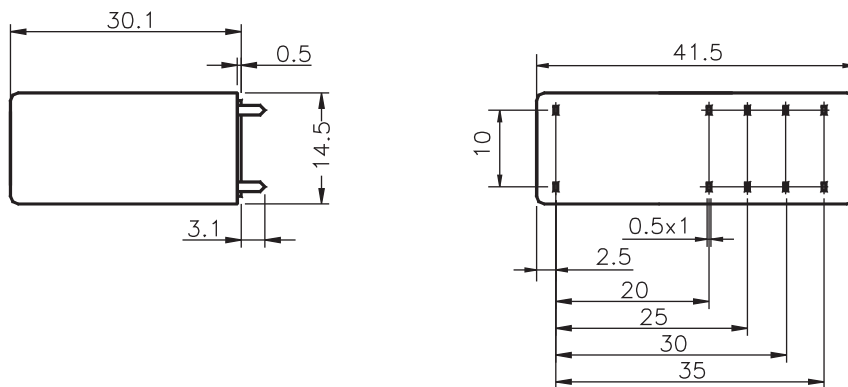

Note: All dimensions are shown in millimeters. To convert to inches, divide by 25.4.

# Safety Relay

## OA 5612

### Features

- 6 output contacts
- International approvals: TÜV, UL, cUL
- Quality control check for each safety relay
- Forced-guided contacts, all gold flash plated
- Contact Gap > 0.5 mm throughout life of relay
- Various contact materials, mixed contact material optional
- High coil voltage range
- Very high switching voltage
- High breakdown voltage: contact/coil  $\geq 4$  KV  
contact/contact  $\geq 2.5$  KV
- High creeping distance: contact/coil  $\geq 8$  mm  
contact/contact  $\geq 4.5$  mm
- Crown contacts
- Solid connection between coil and contact housing
- Compact size
- Custom design available,
  - coil voltage -IP67 washable
  - contact pressure -coil resistance
  - operate/release time
  - low power dissipation models



### Technical Data

- **Nominal Coil Voltage** .....6, 12, 24, 48, 60, 110, DC
- **Coil Power Dissipation** .....0.8 - 1.0 W
- **Max. Switching Voltage** .....250V DC, 400V AC
- **Max. Switching Current** .....8 A
- **Max. Switching Power—DC** .....200W
- **Max. Switching Power—AC** .....2000VA
- **Contact Switching Rate** .....10 operations per second
- **Relay Operate Time** .....20 ms
- **Relay Release Time** .....6 ms
- **Operation Vibration** .....0.35 mm Ampl. max  
..... @ 10...200Hz, 3g max
- **Protection Rating** .....IP 40
- **Contact Arrangements** .....2NO/4NC, 3NO/3NC, 4NO/2NC
- **Contact Material** .....AgNi10+0.2 $\mu$ mAu, AgSnO<sub>2</sub> +0.2 $\mu$ mAu, AgNi10+5 $\mu$ mAu
- **Mechanical Life** ..... $\geq 50 \times 10^6$  operation cycles
- **Electrical Life** .....AgSnO<sub>2</sub>  $> 1.5 \times 10^5$ , AgNi10  $> 10^5$   
.....operation cycles @ 230V AC, 8A,  $\cos \varphi = 1$
- **Ambient Temperature** .....-40...+85°C
- **Cover Material** .....Thermoplast
- **Weight** .....38 g
- More detailed data upon request

### Diagrams

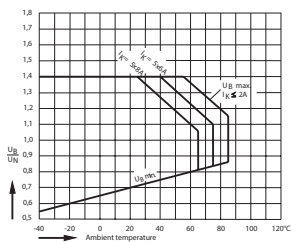

Relay operation voltage vs. ambient temperature

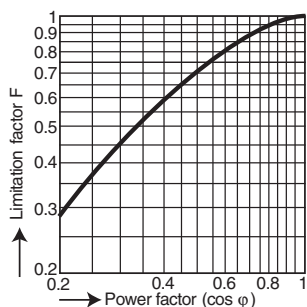

Operations =  
Operations (ohmic) x limitation factor F

Limitation factor for inductive loads

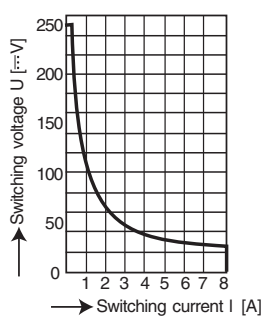

Safe disconnection, no remaining arc, max. 1 operation/sec.

Maximum switching power curve

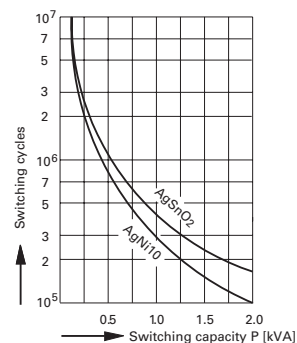

Mechanical life

# Safety Relay OA 5612 Data

## Relay Data

## Ordering Information

| Rated Voltage | Voltage Range | Coil Resistance (10%) | 2 NO/4 NC Type | Coil Resistance (10%) | 3 NO/3 NC Type | 4 NO/2 NC Type |
|---------------|---------------|-----------------------|----------------|-----------------------|----------------|----------------|
| 6V            | 4.2 - 8.4V    | 36 Ω                  | 56.OA12.0624□  | 45 Ω                  | 56.OA12.0633□  | 56.OA12.0642□  |
| 12V           | 8.4 - 16.8V   | 145 Ω                 | 56.OA12.1224□  | 180 Ω                 | 56.OA12.1233□  | 56.OA12.1242□  |
| 24V           | 16.8 - 33.6V  | 600 Ω                 | 56.OA12.2424□  | 720 Ω                 | 56.OA12.2433□  | 56.OA12.2442□  |
| 48V           | 33.6 - 67.2V  | 2300 Ω                | 56.OA12.4824□  | 2880 Ω                | 56.OA12.4833□  | 56.OA12.4842□  |
| 60V           | 42.0 - 84.0V  | 3600 Ω                | 56.OA12.6024□  | 4500 Ω                | 56.OA12.6033□  | 56.OA12.6042□  |
| 110V          | 77.0 - 154.0V | 12100 Ω               | 56.OA12.1124□  | 15125 Ω               | 56.OA12.1133□  | 56.OA12.1142□  |

Contact Material, Example: □ AgSnO<sub>2</sub>+2μmAu

□ AgNi10+2μmAu

□ AgNi10+5μmAu

## Footprints (solder side)

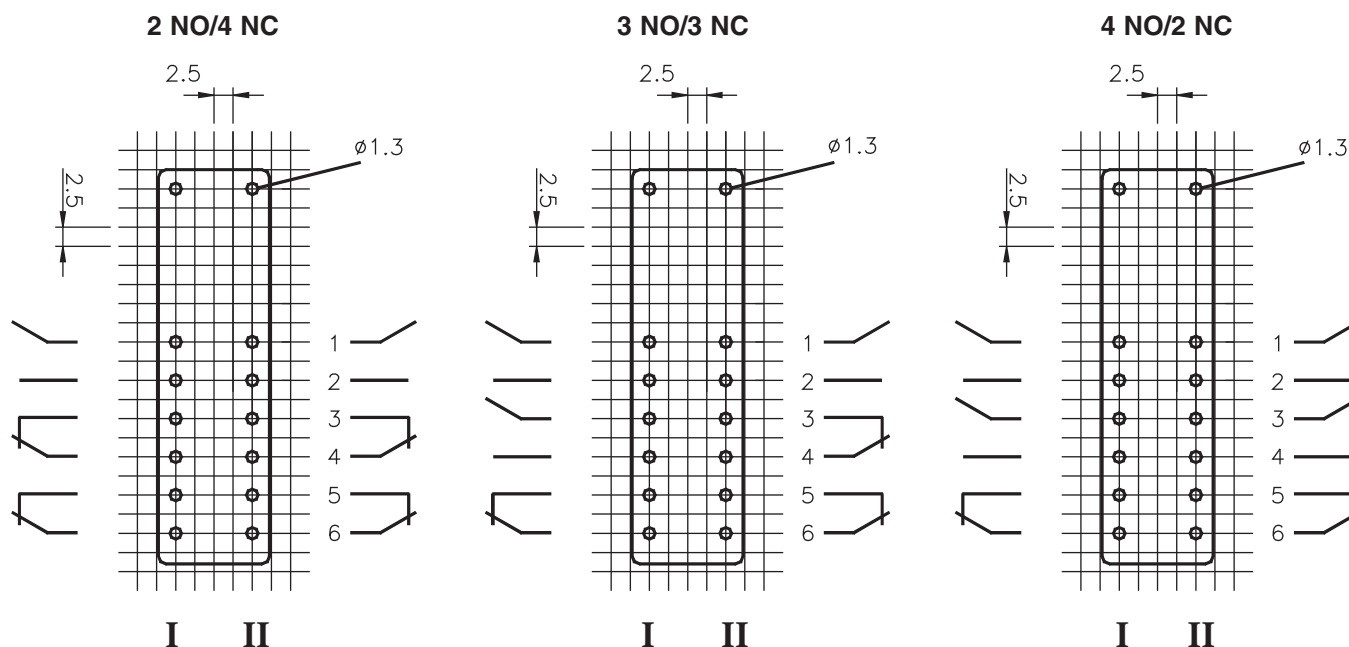

## Dimensions

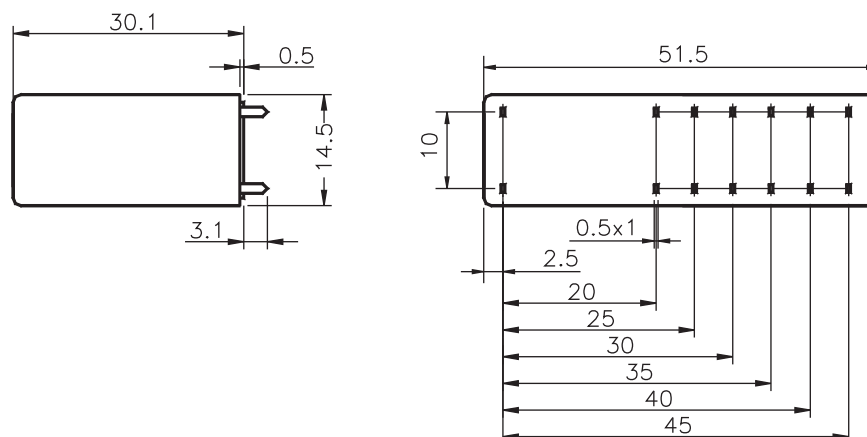

Note: All dimensions are shown in millimeters. To convert to inches, divide by 25.4.

# Safety Relay

## OA 5601

### Features

- 4 output contacts
- International approvals: TÜV, UL, cUL
- Quality control check for each safety relay
- Forced-guided contacts, all gold flash plated
- Contact gap > 0.5 mm throughout life of relay
- Various contact materials, mixed contact material optional
- High coil voltage range
- High switching voltage
- High breakdown voltage: contact/coil  $\geq$  4 KV  
contact/contact  $\geq$  4KV
- High creeping distance: contact/coil  $\geq$  8 mm  
contact/contact  $\geq$  5.5 mm
- Crown contacts
- Solid connection between coil and contact housing
- Custom design available,
  - coil voltage
  - coil resistance,
  - contact pressure
  - operate/release time
  - IP67 washable



GERMANY



USA/CANADA  
E146415

### Technical Data

- **Nominal Coil Voltage** .....6,12 ,24, 48, 60, 110, DC
- **Coil Power Dissipation** .....0.75 W
- **Max. Switching Voltage** .....250V DC, 400V AC
- **Max. Switching Current** .....10 A
- **Max. Switching Power—DC**.....240W
- **Max. Switching Power—AC**.....2500VA
- **Contact Switching Rate** .....10 operations per second
- **Relay Operate Time** .....27 ms
- **Relay Release Time** .....5 ms
- **Operation Vibration** .....0.35 mm Ampl. max  
.....@ 10...55Hz
- **Contact Arrangements**.....2NO/2NC, 3NO/1NC
- **Contact Material**.....AgSnO<sub>2</sub>+0.2μmAu, AgNi10+0.2μmAu, AgNi10+5μmAu
- **Mechanical Life** .....>30x10<sup>6</sup> operation cycles
- **Electrical Life** .....AgSnO<sub>2</sub> >3x10<sup>5</sup>, AgNi10 >2x10<sup>5</sup>  
.....operation cycles @ 230V AC, 10A, cos φ=1
- **Ambient Temperature**.....-40...+85°C
- **Protection Rating** .....IP 40
- **Cover Material**.....Thermoplast
- **Weight**.....78 g
- More detailed data upon request

### Diagrams

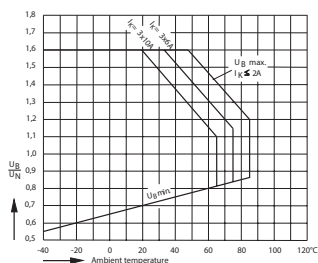

Relay operation voltage vs. ambient temperature

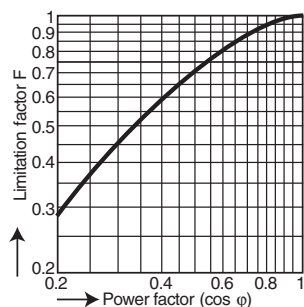

Limitation factor for inductive loads  
Operations =  
Operations (ohmic) x limitation factor F

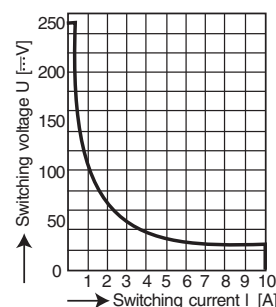

Maximum switching power curve  
Safe disconnection, no remaining arc,  
max. 1 operation/sec.

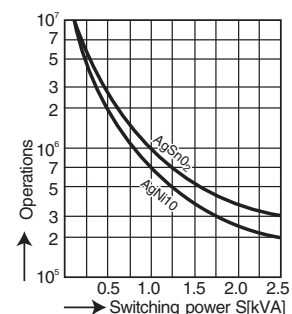

Mechanical life

# Safety Relay OA 5601 Data

| Relay Data    |               |                       | Ordering Information |                |
|---------------|---------------|-----------------------|----------------------|----------------|
| Rated Voltage | Voltage Range | Coil Resistance (10%) | 2 NO/2 NC Type       | 3 NO/1 NC Type |
| 6V            | 4.2 - 9.6V    | 48 Ω                  | 56.OA01.0622□        | 56.OA01.0631□  |
| 12V           | 8.4 - 19.2V   | 192 Ω                 | 56.OA01.1222□        | 56.OA01.1231□  |
| 24V           | 16.8 - 38.4V  | 770 Ω                 | 56.OA01.2422□        | 56.OA01.2431□  |
| 48V           | 33.6 - 76.8V  | 2880 Ω                | 56.OA01.4822□        | 56.OA01.4831□  |
| 60V           | 42.0 - 96.0V  | 4800 Ω                | 56.OA01.6022□        | 56.OA01.6031□  |
| 110V          | 77.0 - 176.0V | 16000 Ω               | 56.OA01.1122□        | 56.OA01.1131□  |

Contact Material, Example: □ AgSnO<sub>2</sub>+2μmAu  
 □ AgNi10+2μmAu  
 □ AgNi10+5μmAu

## Footprints (solder side)

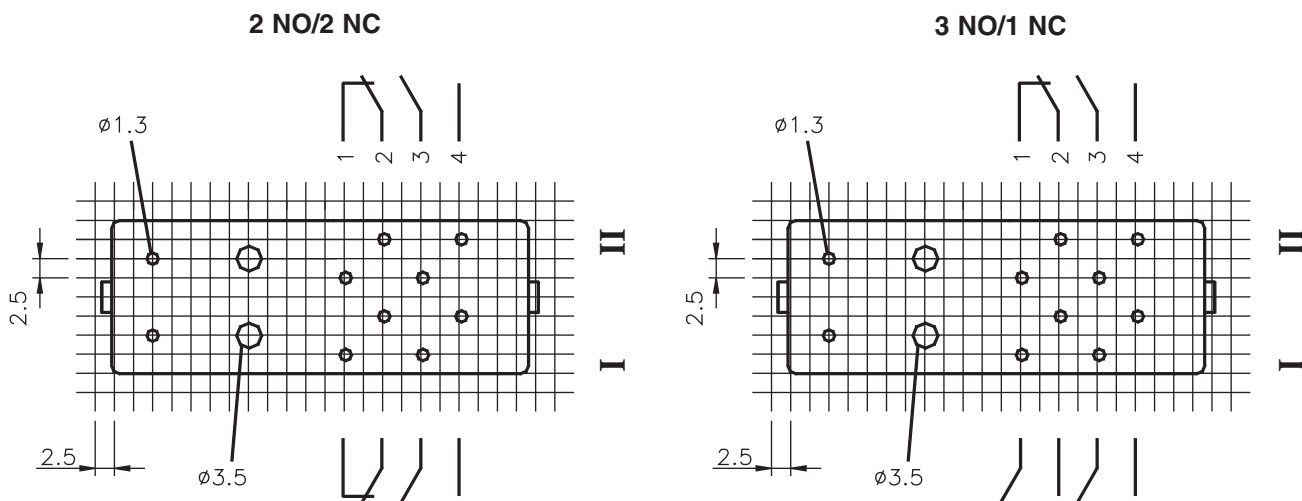

## Dimensions

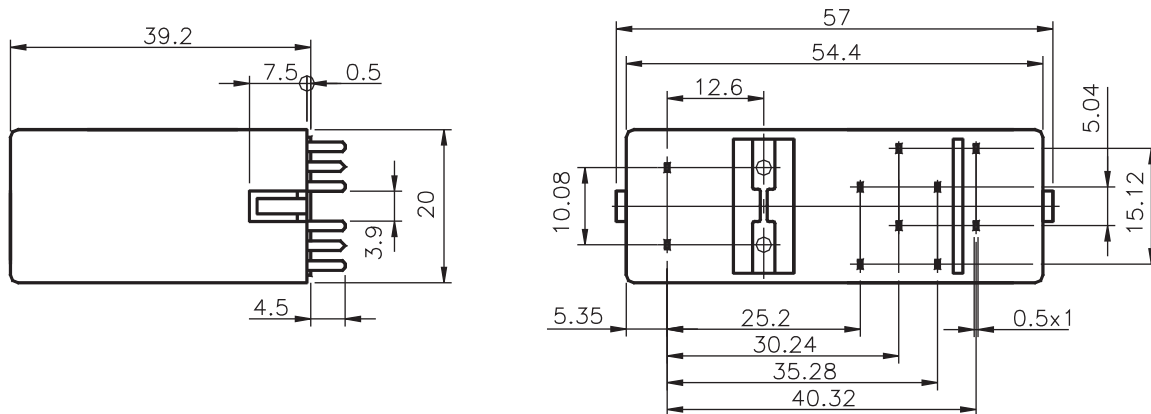

Note: All dimensions are shown in millimeters. To convert to inches, divide by 25.4.

# Safety Relay

## OA 5602

### Features

- 6 output contacts
- International approvals: TÜV, UL, cUL
- Quality control check for each safety relay
- Forced-guided contacts, all gold flash plated
- Contact gap > 0.5 mm throughout life of relay
- Various contact materials, mixed contact material optional
- High coil voltage range
- High switching voltage
- High breakdown voltage: contact/coil  $\geq$  4 KV  
contact/contact  $\geq$  4KV
- High creeping distance: contact/coil  $\geq$  8 mm  
contact/contact  $\geq$  5.5 mm
- Crown contacts
- Solid connection between coil and contact housing
- Custom coil voltage available
- Custom design available,
  - coil voltage
  - coil resistance,
  - contact pressure
  - operate/release time
  - IP67 washable



### Technical Data

- **Nominal Coil Voltage** .....6, 12, 24, 48, 60, 110, DC
- **Coil Power Dissipation** .....1.0 W
- **Max. Switching Voltage** .....250V DC, 400V AC
- **Max. Switching Current** .....10 A
- **Max. Switching Power—DC** .....240W
- **Max. Switching Power—AC** .....2500VA
- **Contact Switching Rate** .....10 operations per second
- **Relay Operate Time** .....27 ms
- **Relay Release Time** .....5 ms
- **Operation Vibration** .....0.35 mm Ampl. max  
.....@ 10...55Hz
- **Protection Rating** .....IP 40
- **Contact Arrangements** .....2NO/4NC, 3NO/3NC, 4NO/2NC
- **Contact Material** .....AgSnO<sub>2</sub>+0.2μmAu, AgNi10+0.2μmAu, AgNi10+5μmAu
- **Mechanical Life** .....>30x10<sup>6</sup> Operation cycles
- **Electrical Life** .....AgSnO<sub>2</sub> >3x10<sup>5</sup>, AgNi10 >2x10<sup>5</sup>  
.....operation cycles @ 230V AC, 10A, cos φ=1
- **Ambient Temperature** .....-40...+85°C
- **Cover Material** .....Thermoplast
- **Weight** .....85 g
- More detailed data upon request

### Diagrams

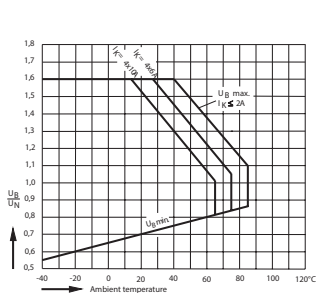

Relay operation voltage vs. ambient temperature

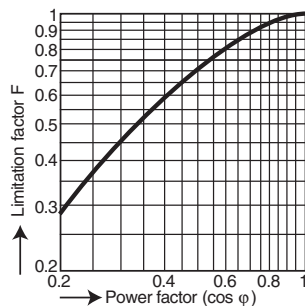

Limitation factor for inductive loads  
Operations = Operations (ohmic) x limitation factor F

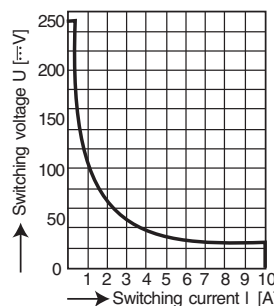

Safe disconnection, no remaining arc,  
max. 1 operation/sec.

Maximum switching power curve



Mechanical life

# Safety Relay OA 5602 Data

| Relay Data    |               |                       | Ordering Information |                |                |
|---------------|---------------|-----------------------|----------------------|----------------|----------------|
| Rated Voltage | Voltage Range | Coil Resistance (10%) | 2 NO/4 NC Type       | 3 NO/3 NC Type | 4 NO/2 NC Type |
| 6V            | 4.2 - 9.6V    | 35 Ω                  | 56.OA02.0624□        | 56.OA02.0633□  | 56.OA02.0642□  |
| 12V           | 8.4 - 19.2V   | 140 Ω                 | 56.OA02.1224□        | 56.OA02.1233□  | 56.OA02.1242□  |
| 24V           | 16.8 - 38.4V  | 570 Ω                 | 56.OA02.2424□        | 56.OA02.2433□  | 56.OA02.2442□  |
| 48V           | 33.6 - 76.8V  | 2300 Ω                | 56.OA02.4824□        | 56.OA02.4833□  | 56.OA02.4842□  |
| 60V           | 42.0 - 96.0V  | 3600 Ω                | 56.OA02.6024□        | 56.OA02.6033□  | 56.OA02.6042□  |
| 110V          | 77.0 - 176.0V | 12100 Ω               | 56.OA02.1124□        | 56.OA02.1133□  | 56.OA02.1142□  |

Contact Material, Example: □ AgSnO<sub>2</sub>+2μmAu

□ AgNi10+.2μmAu

□ AgNi10+5μmAu

## Footprints (solder side)

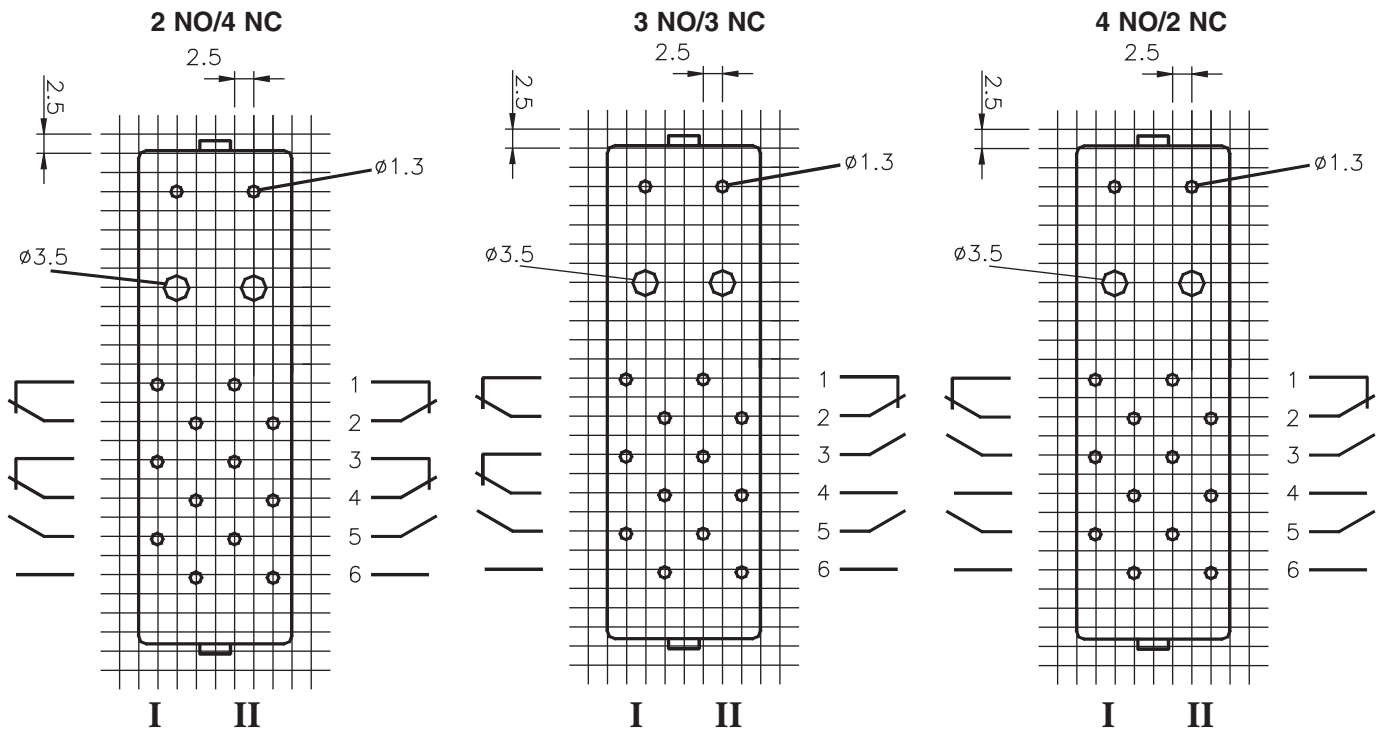

## Dimensions

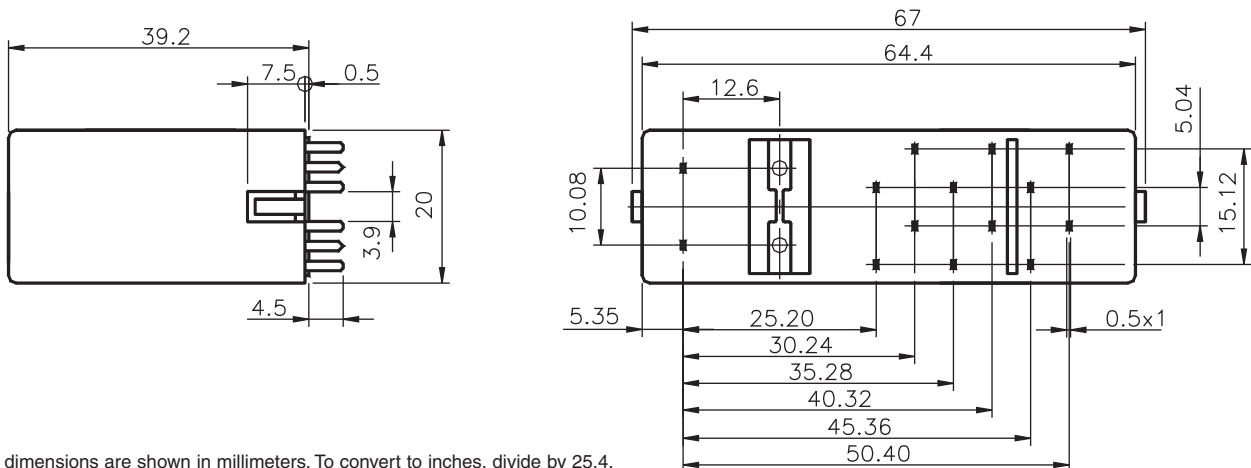

Note: All dimensions are shown in millimeters. To convert to inches, divide by 25.4.

# Safety Relay

## OA 5603

### Features

- 8 output contacts
- International approvals: TÜV, UL, cUL
- Quality control check for each safety relay
- Forced-guided contacts, all gold flash plated
- Contact gap > 0.5 mm throughout life of relay
- Various contact materials, mixed contact material optional
- High coil voltage range
- High switching voltage
- High breakdown voltage: contact/coil  $\geq$  4 KV  
contact/contact  $\geq$  4KV
- High creeping distance: contact/coil  $\geq$  8 mm  
contact/contact  $\geq$  5.5 mm
- Crown contacts
- Solid connection between coil and contact housing
- Custom design available,
  - coil voltage
  - coil resistance,
  - contact pressure
  - operate/release time
- IP67 washable



### Technical Data

- **Nominal Coil Voltage** ..... 6, 12, 24, 48, 60, 110, DC
- **Coil Power Dissipation** ..... 1.25 - 1.65 W
- **Max. Switching Voltage** ..... 250V DC, 400V AC
- **Max. Switching Current** ..... 10 A
- **Max. Switching Power—DC** ..... 240W
- **Max. Switching Power—AC** ..... 2500VA
- **Contact Switching Rate** ..... 10 operations per second
- **Relay Operate Time** ..... 27 ms
- **Relay Release Time** ..... 5 ms
- **Operation Vibration** ..... 0.35 mm Ampl. max  
..... @ 10...55Hz
- **Protection Rating** ..... IP 40
- **Contact Arrangements** .....  
.....2NO/6NC, 3NO/5NC, 4NO/4NC, 5NO/3NC,  
.....6NO/2NC, 7NO/1NC
- **Contact Material** .....  
AgSnO<sub>2</sub>+0.2μmAu , AgNi10+0.2μmAu , AgNi10+5μmAu
- **Mechanical Life** ..... >30x10<sup>6</sup> Operation cycles
- **Electrical Life** ..... AgSnO<sub>2</sub> >3x10<sup>5</sup>, AgNi10 >2x10<sup>5</sup>  
.....operation cycles @ 230V AC, 10A, cos φ=1
- **Ambient Temperature** ..... -40...+75°C
- **Cover Material** ..... Thermoplast
- **Weight** ..... 95 g
- More detailed data upon request

### Diagrams



Relay operation voltage vs. ambient temperature

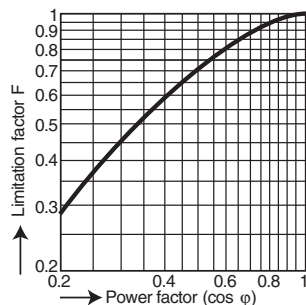

Limitation factor for inductive loads  
Operations =  
Operations (ohmic) x limitation factor F

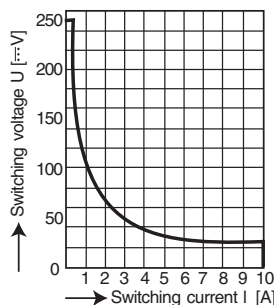

Safe disconnection, no remaining arc,  
max. 1 operation/sec.  
Maximum switching power curve

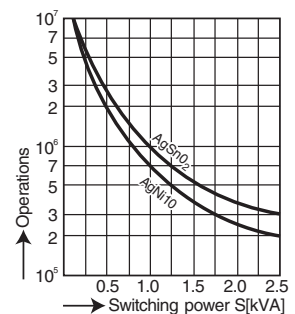

Mechanical life



# Safety Relay OA 5603 Data

## Relay Data

## Ordering Information

| Rated Voltage | Voltage Range | Coil Resistance (10%) | 2 NO/6 NC Type | 3 NO / 5 NC Type | Coil Resistance (10%) | 4 NO / 4 NC Type | 5 NO / 3 NC Type | 6 NO / 2 NC Type | 7 NO / 1 NC Type |
|---------------|---------------|-----------------------|----------------|------------------|-----------------------|------------------|------------------|------------------|------------------|
| 6V            | 4.2 - 9.6V    | 21 Ω                  | 56.OA03.0626□  | 56.OA03.0635□    | 29 Ω                  | 56.OA03.0644□    | 56.OA03.0653□    | 56.OA03.0662□    | 56.OA03.0671□    |
| 12V           | 8.4 - 19.2V   | 88 Ω                  | 56.OA03.1226□  | 56.OA03.1235□    | 112 Ω                 | 56.OA03.1244□    | 56.OA03.1253□    | 56.OA03.1262□    | 56.OA03.1271□    |
| 24V           | 16.8 - 38.4V  | 370 Ω                 | 56.OA03.2426□  | 56.OA03.2435□    | 460 Ω                 | 56.OA03.2444□    | 56.OA03.2453□    | 56.OA03.2462□    | 56.OA03.2471□    |
| 48V           | 33.6 - 76.8V  | 1400 Ω                | 56.OA03.4826□  | 56.OA03.4835□    | 1800 Ω                | 56.OA03.4844□    | 56.OA03.4853□    | 56.OA03.4862□    | 56.OA03.4871□    |
| 60V           | 42.0 - 96.0V  | 2230 Ω                | 56.OA03.6026□  | 56.OA03.6035□    | 2880 Ω                | 56.OA03.6044□    | 56.OA03.6053□    | 56.OA03.6062□    | 56.OA03.6071□    |
| 110V          | 77.0 - 176.0V | 7150 Ω                | 56.OA03.1126□  | 56.OA03.1135□    | 9500 Ω                | 56.OA03.1144□    | 56.OA03.1153□    | 56.OA03.1162□    | 56.OA03.1171□    |

Contact Material, Example: □ AgSnO<sub>2</sub>+2μmAu

□ AgNi10+2μmAu

□ AgNi10+5μmAu

## Footprints (solder side)

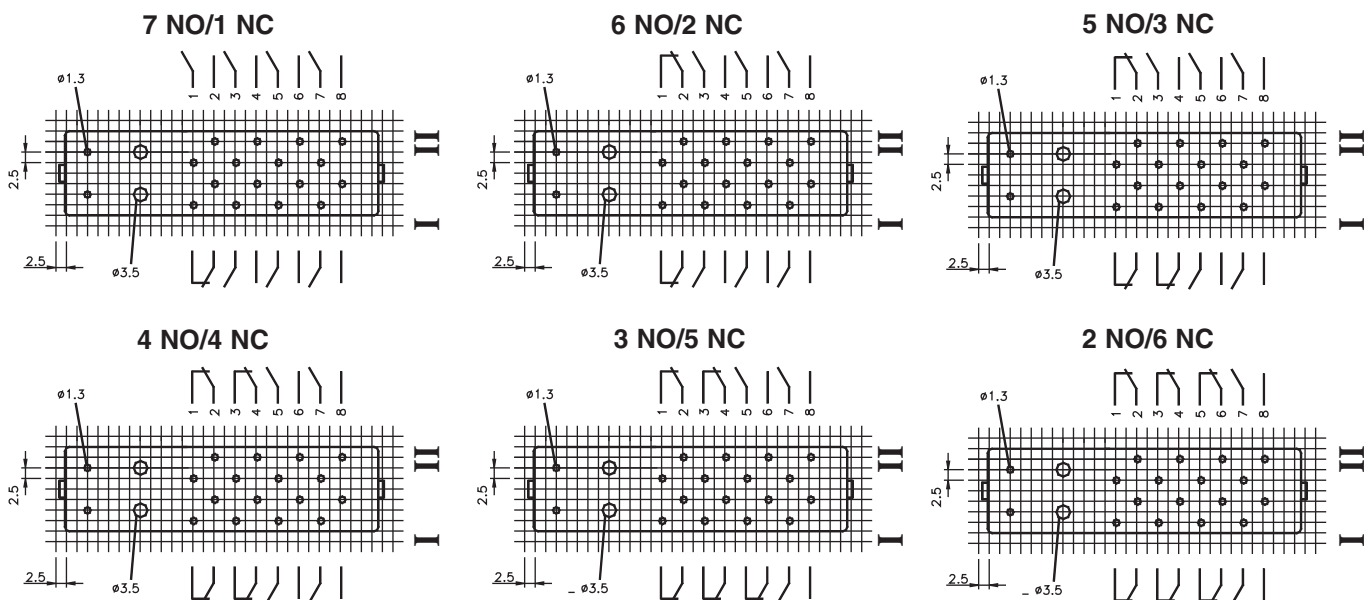

## Dimensions

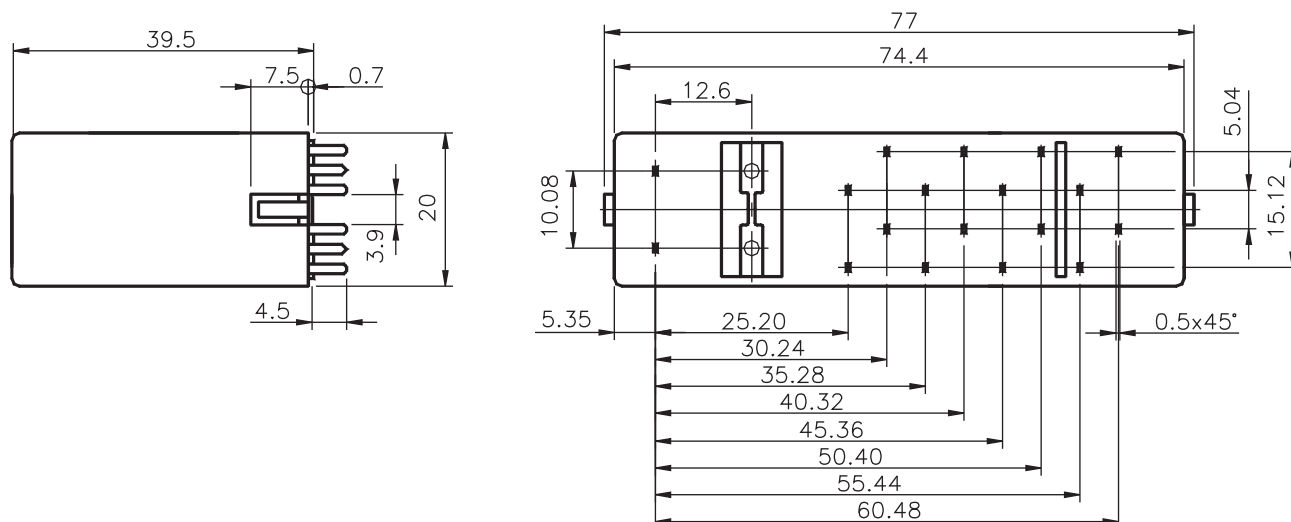

Note: All dimensions are shown in millimeters. To convert to inches, divide by 25.4.

## SAFETY RELAY MODULES

### SAFETY RELAY MODULES

#### 8 Amp Contacts, 35 or 32mm DIN Rail

Altech Safety Relay Modules utilize Relays with Force-Guided-Contacts that meet or exceed international standards, TÜV and UL. They are designed to protect man and machine as specified in OSHA FR1910 Regulations, a mandatory requirement of the European Machinery Directive EMD 89.392 EEC. The Safety Relays are used in Safety Devices such as Emergency Stop Modules, Safety Gate Monitors, 2-Hand Safety Modules, etc.

This series of Safety Relay Modules are Double Pole, Double Throw configurations, and are available as 1, 2, 4, 8 and 16 isolated channels and 8 and 16 bussed channels with 12 or 24 VDC coils. Isolated channels allow control of each relay by a different logic system, if necessary. There are two inputs for each relay coil per channel. Bussed channels allow high density packaging with a common input for all relays. Safety Relay Modules may be ordered with three different types of relay contact material, depending on the actual load current.

- Screw-Cage Clamp Connection
- LED Coil Voltage Indicator
- Reverse DC Polarity LED Protection
- Surge Suppression With DC Coils
- Industry Standard Relays
- DIN Rail Mount, Panel Mount Available

### Isolated Channel Double Pole Double Throw

### Bussed Channel Double Pole Double Throw

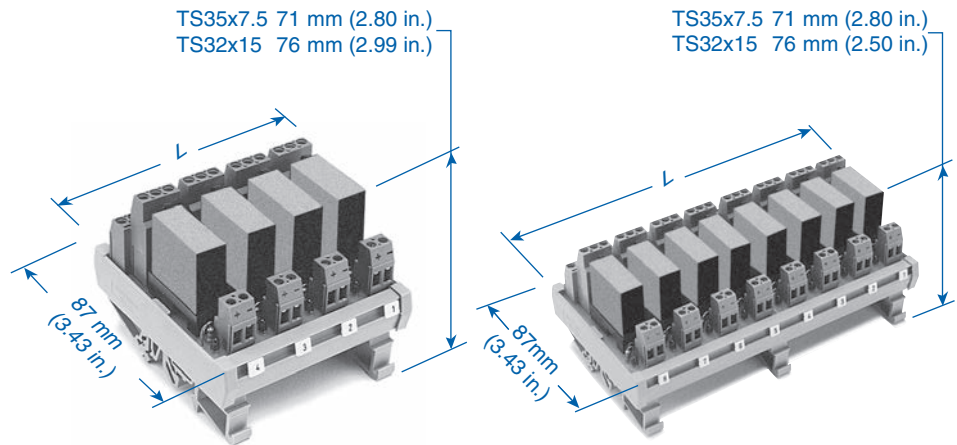

|   |  |  |
|---|--|--|
| <b>Contact Material:</b><br>AgSnO <sub>2</sub> +0.2µmAu<br><b>Contact Ratings:</b><br>8A(2x5A) 250VDC, 400VAC | <b>Contact Material:</b><br>AgNi10+0.2µmAu<br><b>Contact Ratings:</b><br>8A(2x5A) 250VDC, 400VAC | <b>Contact Material:</b><br>AgNi10+5µmAu<br><b>Contact Ratings:</b><br>8A(2x5A) 250VDC, 400VAC |
|---|--|--|

| Isolated Channels (No Bus) | Length (L) mm (in.) | Type/Cat. No. | Type/ Cat. No. | Type/Cat. No. |
|----------------------------|---------------------|---------------|----------------|---------------|
| 1 Channel, Coil Voltage    | 21 (0.83)           | 8949.2C       | 8949.2N        | 8949.2S       |
|                            |                     | 8951.2C       | 8951.2N        | 8951.2S       |
|                            |                     |               |                |               |
| 2 Channel, Coil Voltage    | 40 (1.57)           | 8949.3C       | 8949.3N        | 8949.3S       |
|                            |                     | 8951.3C       | 8951.3N        | 8951.3S       |
|                            |                     |               |                |               |
| 4 Channel, Coil Voltage    | 79 (3.11)           | 8955.2C       | 8955.2N        | 8955.2S       |
|                            |                     | 8956.2C       | 8956.2N        | 8956.2S       |
|                            |                     |               |                |               |
| 8 Channel, Coil Voltage    | 157 (6.18)          | 8955.3C       | 8955.3N        | 8955.3S       |
|                            |                     | 8956.3C       | 8956.3N        | 8956.3S       |
|                            |                     |               |                |               |
| 16 Channel, Coil Voltage   | 311 (12.24)         | 8963.2C       | 8963.2N        | 8963.2S       |
|                            |                     | 8972.2C       | 8972.2N        | 8972.2S       |
|                            |                     |               |                |               |
| Bussed Channels            | Length (L) mm (in.) | Type/Cat. No. | Type/Cat. No.  | Type/Cat. No. |
| 8 Channel, Bussed DC+      | 125 (4.92)          | 8923.2C       | 8923.2N        | 8923.2S       |
|                            |                     | 8924.2C       | 8924.2N        | 8924.2S       |
|                            |                     |               |                |               |
| 8 Channel, Bussed DC-      | 125 (4.92)          | 8923.3C       | 8923.3N        | 8923.3S       |
|                            |                     | 8924.4C       | 8924.4N        | 8924.4S       |
|                            |                     |               |                |               |
| 16 Channel, Bussed DC+     | 248 (9.76)          | 8926.2C       | 8926.2N        | 8926.2S       |
|                            |                     | 8926.3C       | 8926.3N        | 8926.3S       |
|                            |                     |               |                |               |
| 16 Channel, Bussed DC-     | 248 (9.76)          | 8927.2C       | 8927.2N        | 8927.2S       |
|                            |                     | 8927.3C       | 8927.3N        | 8927.3S       |
|                            |                     |               |                |               |

## Isolated Channel, DPDT



Bottom View, Relay Pinouts, Grid 2.54mm (0.1in.)

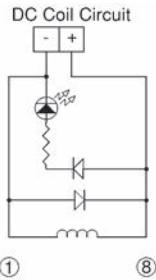

① ⑧

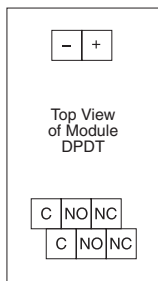

Top View of Module DPDT

## Bussed Channel, DPDT

### Relay Pinout

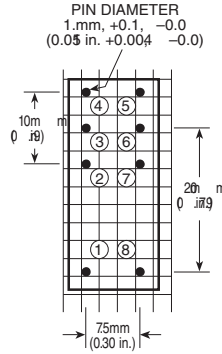

### Coil Circuits

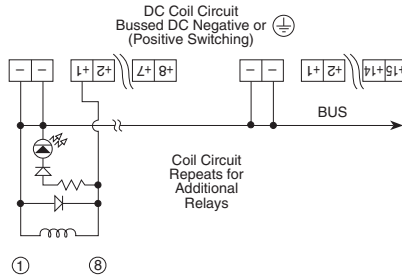

① ⑧

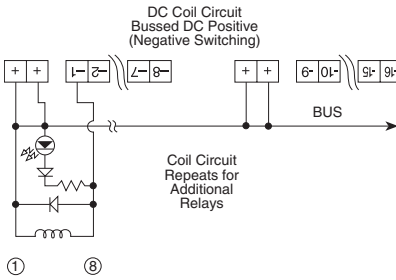

① ⑧

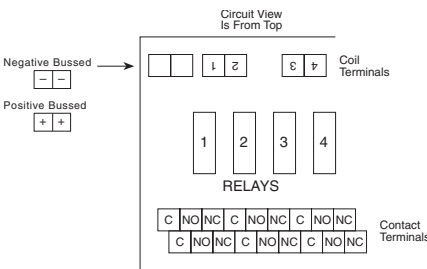

Circuit View Is From Top

Negative Bussed

Positive Bussed

Coil Terminals

RELAYS

Contact Terminals

### Contact Circuits

For Both Isolated and Bussed Channels

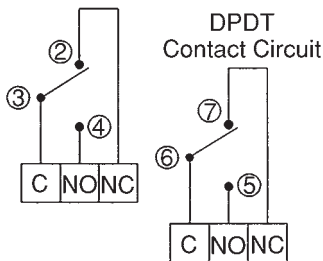

DPDT Contact Circuit

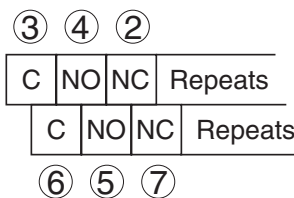

## Relay Specifications

-Normal Coil Voltage: 12,24 VDC  
 -Coil Power Dissipation: 0.7W  
 -Max. Switching Voltage: 250VDC, 400VAC  
 -Max. Switching Current: 8A(2x5A simultaneous)

-Max. Switching Power:  
 DC: 200W (2x160W simultaneous)  
 AC: 2000VA (2x1250VA simultaneous)

-Contact Switching Rate: 10 operations/ sec.  
 -Relay Operate Time: ≤ 15 ms  
 -Relay Release Time: ≤ 12 ms  
 -Contact Arrangements: DPDT, 2 FORM C

-Contact Material:  
 Standard: AgNi10+0.2μmAu  
 Optional: AgSnO<sub>2</sub>+0.2μmAu  
 AgNi10+5μmAu

-Mechanical Life: ≥ 50x10<sup>6</sup> operation cycles  
 -Ambient Temperature: -40° + 70°C  
 -Cover Material: Polyamide 6  
 -Weight: 15g

## Coil Specifications

| Rated Voltage | Voltage Range | Coil Resistance |
|---------------|---------------|-----------------|
| 12VDC         | 9.6V-19.2V    | 210Ω ± 10%      |
| 24VDC         | 19.2V-38.4V   | 820Ω ± 10%      |

## SAFETY RELAY MODULES

### SAFETY RELAY MODULES 4 Pole Relays, 8 or 10 Amps

Altech Safety Relay Modules utilize Relays with Force-Guided-Contacts that meet or exceed international standards, TÜV and UL. They are designed to protect man and machine as specified in OSHA CFR1910 Regulations, which is a mandatory requirement of the European Machinery Directive EMD 89.392 EEC.

Altech Safety Relays are electro-mechanical relays that are mechanically linked together, causing all contacts to move together when the coil is energized. Force-Guided-contacts are also known as positive-guided-contacts, captive contacts or locked contacts. In addition, our Safety Relays have Crown Contacts which provide two locations per contacts to improve switching conditions. The Safety Relays are used in Safety Devices such as Emergency Stop Modules, Safety Gate Monitors, 2-Hand Safety Modules, Safety Light Curtains, etc.

This series of Safety Relay Modules consist of 4 pole relays with two choices of configurations (2NO/2NC or 3NO/1NC), with 8 or 10 Amp contacts, and are available as 1, 2, and 4 isolated channels with 12, or 24 VDC coils. Isolated channels allows control of each relay by a different logic system, if necessary. There are two inputs for each relay coil per channel. Safety Relay Modules may be ordered with three different types of relay contact material, depending on the actual load current. The part numbers shown in this data sheet are for our standard contact material, which is  $\text{AgSnO}_2 + 0.2\mu\text{mAu}$ .

- Screw-Cage clamp Connections
- LED Coil Voltage Indicator
- Reverse DC Polarity LED Protection
- Surge Suppression With DC Coil
- Din Rail Mount, Panel Mount Available

### 4 Pole, 8 Amp

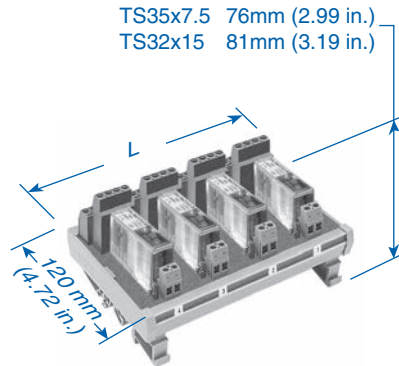

### 4 Pole, 10 A

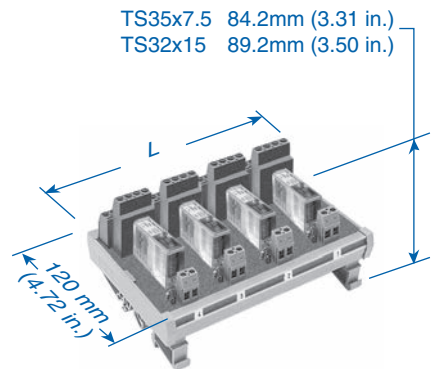

| Ordering Information                         |                | Contact Material*:<br>$\text{AgSnO}_2 + 0.2\mu\text{mAu}$ |                                  | Contact Material*:<br>$\text{AgSnO}_2 + 0.2\mu\text{mAu}$ |                                  |
|--|----------------|---|----------------------------------|---|----------------------------------|
| Length (L) mm (in.)                          |                | Contact Ratings:<br>8A(2x5A) 250VDC, 400VAC               |                                  | Contact Ratings:<br>10A(2x5A) 250VDC, 400VAC              |                                  |
|  |                | Contacts:   |                                  | Contacts:   |                                  |
|  |                | 2N.O + 2N.C   | 3N.O + 1N.C                      | 2N.O + 2N.C   | 3N.O + 1N.C                      |
| Type/ Cat. No.                               | Type/ Cat. No. | Type/ Cat. No.  | Type/ Cat. No.                   | Type/ Cat. No.  | Type/ Cat. No.                   |
| <b>1 Channel, Coil Voltage</b><br>12V<br>24V | 40.10 (1.58)   | 156.0A11.1222C<br>156.0A11.2422C                          | 156.0A11.1231C<br>156.0A11.2431C | 156.0A01.1222C<br>156.0A01.2422C                          | 156.0A01.1231C<br>156.0A01.2431C |
| <b>2 Channel, Coil Voltage</b><br>12V<br>24V | 78.20 (3.08)   | 256.0A11.1222C<br>256.0A11.2422C                          | 256.0A11.1231C<br>256.0A11.2431C | 256.0A01.1222C<br>256.0A01.2422C                          | 256.0A01.1231C<br>256.0A01.2431C |
| <b>4 Channel, Coil Voltage</b><br>12V<br>24V | 154.40 (6.08)  | 456.0A11.1222C<br>456.0A11.2422C                          | 456.0A11.1231C<br>456.0A11.2431C | 456.0A01.1222C<br>456.0A01.2422C                          | 456.0A01.1231C<br>456.0A01.2431C |

\* Note: Additional relay contact materials are available upon request. Please contact Altech for additional information.

## 4 Pole, 8 Amps

## 4 Pole, 10 Amps

### DC Coil Circuits

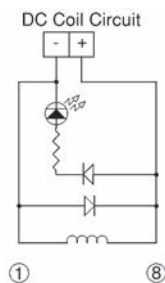
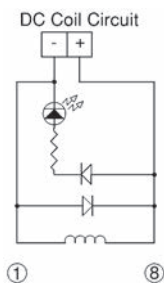

### Contact Circuits

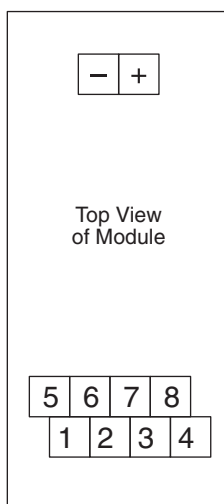
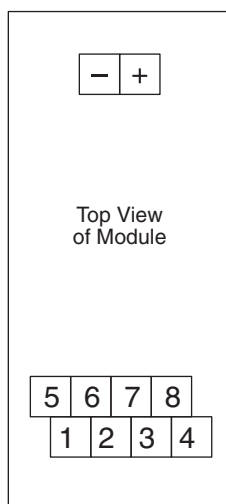

#### Relay Configurations

2 N.O + 2 N.C  
 NO Pin (1,2), (5,6)  
 NC Pin (3,4), (7,8)

3 N.O + 1 N.C  
 NO Pin (1,2), (5,6), (7,8)  
 NC Pin (3,4)

#### Relay Configurations

2 N.O + 2 N.C  
 NO Pin (3,4), (7,8)  
 NC Pin (1,2), (5,6)

3 N.O + 1 N.C  
 NO Pin (3,4), (5,6), (7,8)  
 NC Pin (1,2)

## Relay Specifications - 8 Amps

-Normal Coil Voltage: 12,24 VDC  
 -Coil Power Dissipation: 0.6W  
 -Max. Switching Voltage: 250VDC, 400VAC  
 -Max. Switching Current: 8A

-Max. Switching Power:  
 DC: 200W  
 AC: 2000VA

-Contact Switching Rate: 10 operations/ sec.  
 -Relay Operate Time: ≤ 20 ms  
 -Relay Release Time: ≤ 6 ms  
 -Contact Arrangements: 2NO/2NC, 3NO/1NC

-Contact Material:  
 Standard: AgSnO<sub>2</sub>+0.2μmAu  
 Optional: AgNi10+0.2μmAu  
 AgNi10+5μmAu

-Mechanical Life: ≥ 50x10<sup>6</sup> operation cycles  
 -Ambient Temperature: -40° + 85°C  
 -Cover Material: Thermoplast  
 -Weight: 35g

### Coil Specifications

| Rated Voltage | Voltage Range | Coil Resistance |
|---------------|---------------|-----------------|
| 12VDC         | 8.4V-16.8V    | 240Ω ± 10%      |
| 24VDC         | 16.8V-33.6V   | 960Ω ± 10%      |

## Relay Specifications - 10 Amps

-Normal Coil Voltage: 12,24 VDC  
 -Coil Power Dissipation: 0.75W  
 -Max. Switching Voltage: 250VDC, 400VAC  
 -Max. Switching Current: 10A

-Max. Switching Power:  
 DC: 240W  
 AC: 2500VA

-Contact Switching Rate: 10 operations/ sec.  
 -Relay Operate Time: ≤ 27 ms  
 -Relay Release Time: ≤ 5 ms  
 -Contact Arrangements: 2NO/2NC, 3NO/1NC

-Contact Material:  
 Standard: AgSnO<sub>2</sub>+0.2μmAu  
 Optional: AgNi10+0.2μmAu  
 AgNi10+5μmAu

-Mechanical Life: > 30x10<sup>6</sup> operation cycles  
 -Ambient Temperature: -40° + 80°C  
 -Cover Material: Thermoplast  
 -Weight: 78g

### Coil Specifications

| Rated Voltage | Voltage Range | Coil Resistance |
|---------------|---------------|-----------------|
| 12VDC         | 8.4V-19.2V    | 192Ω ± 10%      |
| 24VDC         | 16.8V-38.4V   | 770Ω ± 10%      |

## SAFETY RELAY MODULES

### SAFETY RELAY MODULES 6 Pole Relays, 8 or 10 Amps

Altech Safety Relay Modules utilize Relays with Force-Guided-Contacts that meet or exceed international standards, TÜV and UL. They are designed to protect man and machine as specified in OSHA CFR1910 Regulations, which is a mandatory requirement of the European Machinery Directive EMD 89.392 EEC.

Altech Safety Relays are electro-mechanical relays that are mechanically linked together, causing all contacts to move together when the coil is energized. Force-Guided-contacts are also known as positive-guided-contacts, captive contacts or locked contacts. In addition, our Safety Relays have Crown Contacts which provides two locations per contacts to improve switching conditions. The Safety Relays are used in Safety Devices such as Emergency Stop Modules, Safety Gate Monitors, 2-Hand Safety Modules, Safety Light Curtains, etc.

This series of Safety Relay Modules consist of 6 pole relays with three configuration choices (2NO+4NC, 3NO+3NC, 4NO+2NC), 8 or 10 Amp contacts and either 1, 2 and 4 isolated channels with 12 or 24 VDC coils. Isolated channels allow control of each relay by a different logic system, if necessary. There are two inputs for each relay coil channel. Modules can be ordered with three contact materials, dependent upon the actual current load. The standard contact material is AgSnO<sub>2</sub> + 0.2µmAu.

- Screw-Cage clamp Connections
- LED Coil Voltage Indicator
- Reverse DC Polarity LED Protection
- Surge Suppression With DC Coil
- Din Rail Mount, Panel Mount Available

### 6 Pole, 8 Amps



### 6 Pole, 10 Amps

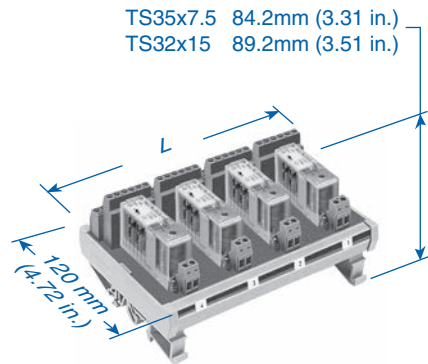

| Ordering Information                         | Length (L) mm (in.) | Contact Material*:<br>AgSnO <sub>2</sub> +0.2µmAu |                |                | Contact Material*:<br>AgSnO <sub>2</sub> +0.2µmAu |                |                |
|--|---------------------|---|----------------|----------------|---|----------------|----------------|
|  |                     | Contact Ratings:<br>8A(2x5A) 250VDC, 400VAC       |                |                | Contact Ratings:<br>10A(2x5A) 250VDC, 400VAC      |                |                |
|  |                     | Contacts:   |                |                | Contacts:   |                |                |
|  |                     | 2N.O + 4N.C                                       | 3N.O + 3N.C    | 4N.O + 2N.C    | 2N.O + 4N.C                                       | 3N.O + 3N.C    | 4N.O + 2N.C    |
| Type/ Cat. No.                               | Type/ Cat. No.      | Type/ Cat. No.                                    | Type/ Cat. No. | Type/ Cat. No. | Type/ Cat. No.                                    | Type/ Cat. No. | Type/ Cat. No. |
| <b>1 Channel, Coil Voltage</b><br>12V<br>24V | 46.45 (1.83)        | 156.0A12.1224C                                    | 156.0A12.1233C | 156.0A12.1242C | 156.0A02.1224C                                    | 156.0A02.1233C | 156.0A02.1242C |
|  |                     | 156.0A12.2424C                                    | 156.0A12.2433C | 156.0A12.2442C | 156.0A02.2424C                                    | 156.0A02.2433C | 156.0A02.2442C |
| <b>2 Channel, Coil Voltage</b><br>12V<br>24V | 90.90 (3.58)        | 256.0A12.1224C                                    | 256.0A12.1233C | 256.0A12.1242C | 256.0A02.1224C                                    | 256.0A02.1233C | 256.0A02.1242C |
|  |                     | 256.0A12.2424C                                    | 256.0A12.2433C | 256.0A12.2442C | 256.0A02.2424C                                    | 256.0A02.2433C | 256.0A02.2442C |
| <b>4 Channel, Coil Voltage</b><br>12V<br>24V | 179.80 (7.08)       | 456.0A12.1224C                                    | 456.0A12.1233C | 456.0A12.1242C | 456.0A02.1224C                                    | 456.0A02.1233C | 456.0A02.1242C |
|  |                     | 456.0A12.2424C                                    | 456.0A12.2433C | 456.0A12.2442C | 456.0A02.2424C                                    | 456.0A02.2433C | 456.0A02.2442C |

\* Note: Additional relay contact materials are available upon request. Please contact Altech for additional information.

## 6 Pole, 8 Amps

## 6 Pole, 10 Amps

### DC Coil Circuits

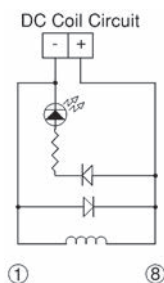
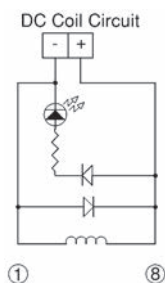

### Contact Circuits

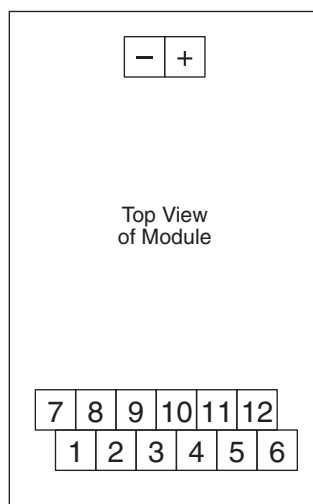

#### Relay Configurations

2N.O + 4N.C  
 NO Pin (1,2), (7,8)  
 NC Pin (3,4), (5,6), (9,10), (11,12)

3N.O + 3N.C  
 NO Pin (1,2), (7,8), (9,10)  
 NC Pin (3,4), (5,6), (11,12)

4N.O + 2N.C  
 NO Pin (1,2), (3,4), (7,8), (9,10)  
 NC Pin (5,6), (11,12)

#### Relay Configurations

2N.O + 4N.C  
 NO Pin (5,6), (11,12)  
 NC Pin (1,2), (3,4), (7,8), (9,10)

3N.O + 3N.C  
 NO Pin (3,4), (5,6), (11,12)  
 NC Pin (1,2), (7,8), (9,10)

4N.O + 2N.C  
 NO Pin (3,4), (5,6), (9,10), (11,12)  
 NC Pin (1,2), (7,8)

## Relay Specifications - 8 Amps

-Normal Coil Voltage: 12,24 VDC  
 -Coil Power Dissipation: 0.8-1.0 W  
 -Max. Switching Voltage: 250VDC, 400VAC  
 -Max. Switching Current: 8A

-Max. Switching Power  
 DC 200W (2x160W simultaneous)  
 AC 2000VA (2x1250VA simultaneous)

-Contact Switching Rate: 10 operations/ sec.  
 -Relay Operate Time ≤ 20 ms  
 -Relay Release Time ≤ 6 ms  
 -Contact Arrangements 2NO/4NC, 3NO/3NC, 4NO/2NC

-Contact Material:  
 Standard AgSnO<sub>2</sub>+0.2μmAu  
 Optional AgNi10+0.2μmAu  
 AgNi10+5μmAu

-Mechanical Life: ≥ 50x10<sup>6</sup> operation cycles  
 -Ambient Temperature: -40° + 85°C  
 -Cover Material: Thermoplast  
 -Weight: 38g

### Coil Specifications

| Rated Voltage | Voltage Range | Coil Resistance |
|---------------|---------------|-----------------|
| 12VDC         | 8.4V-16.8V    | 145Ω ± 10%      |
| 24VDC         | 16.8V-33.6V   | 600Ω ± 10%      |

## Relay Specifications - 10 Amps

-Normal Coil Voltage: 12,24 VDC  
 -Coil Power Dissipation: 1.0 W  
 -Max. Switching Voltage: 250VDC, 400VAC  
 -Max. Switching Current: 10A

-Max. Switching Power  
 DC 240W  
 AC 2500VA

-Contact Switching Rate: 10 operations/ sec.  
 -Relay Operate Time ≤ 27 ms  
 -Relay Release Time ≤ 5 ms  
 -Contact Arrangements 2NO/4NC, 3NO/3NC, 4NO/2NC

-Contact Material:  
 Standard AgSnO<sub>2</sub>+0.2μmAu  
 Optional AgNi10+0.2μmAu  
 AgNi10+5μmAu

-Mechanical Life: > 30x10<sup>6</sup> operation cycles  
 -Ambient Temperature: -40° + 80°C  
 -Cover Material: Thermoplast  
 -Weight: 85g

### Coil Specifications

| Rated Voltage | Voltage Range | Coil Resistance |
|---------------|---------------|-----------------|
| 12VDC         | 8.4V-19.2V    | 140Ω ± 10%      |
| 24VDC         | 16.8V-38.4V   | 570Ω ± 10%      |

# Accessories



PCB Socket for OA/OW 5669\*



Socket for OA 5601\*

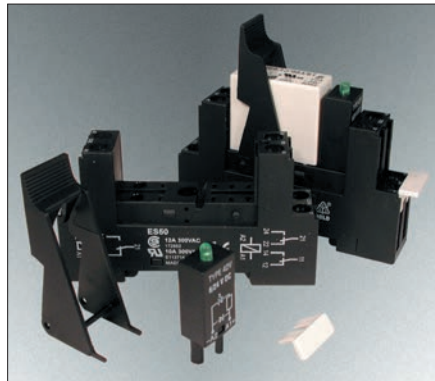

DIN Rail Socket for OA/OW 5669\*



Socket for OA 5602\*



Socket for OA 5603\*



Extraction Tool



Socket for OA 5611/12\*



Socket for OA 5621/22\*



# Ordering Information

| Relay Style | Matching Socket | Socket Type | Extraction-Tool Type | Hold Down Clip Type | LED Module AC/DC, Green LED | Diode Module DC Red, LED |
|-------------|-----------------|-------------|----------------------|---------------------|-----------------------------|--------------------------|
| OA/OW 5669  | 56.5669.00      | PCB         | n.a.                 | 56.5669.99          | n.a.                        | n.a.                     |
| OA/OW 5669  | 56.5669.DR      | DIN Rail    | n.a.                 | included            | 56.5669.GR                  | 56.5669.RE               |
| OA 5667     | n.a.            | PCB         | n.a.                 | n.a.                | n.a.                        | n.a.                     |
| OA 5601     | 56.5601.01      | PCB         | 56.5601.10           | n.a.                | n.a.                        | n.a.                     |
| OA 5602     | 56.5602.02      | PCB         | 56.5602.20           | n.a.                | n.a.                        | n.a.                     |
| OA 5603     | 56.5603.03      | PCB         | n.a.                 | n.a.                | n.a.                        | n.a.                     |
| OA 5611     | 56.5611.11      | PCB         | n.a.                 | n.a.                | n.a.                        | n.a.                     |
| OA 5612     | 56.5612.12      | PCB         | n.a.                 | n.a.                | n.a.                        | n.a.                     |
| OA 5621     | 56.5621.21      | PCB         | n.a.                 | n.a.                | n.a.                        | n.a.                     |
| OA 5622     | 56.5622.22      | PCB         | n.a.                 | n.a.                | n.a.                        | n.a.                     |

\*Current data sheets of sockets are available on request.



# Applications

Safety relays with forced-guided contacts are the core components for safety devices and are indispensable when designing safety circuits. Safety devices are designed to protect man and machine as demanded in OSHA CFR 1910 Regulations “General Requirements for All Machinery”, and which is a mandatory requirement of the European Machinery Directive EMD 2006/42/EC.

DOLD safety relays, manufactured according to DIN EN 50205 and IEC/EN61810 are approved for use in safety applications to IEC 60204, EN 60204, DIN/VDE 0113, as well as Escalator Standard EN 115/06.95 and Elevator Standard EN 81-1 (electric) and EN81-2 (hydraulic), and in safety related parts of control systems in IEC/EN 62061 and EN ISO 13849.

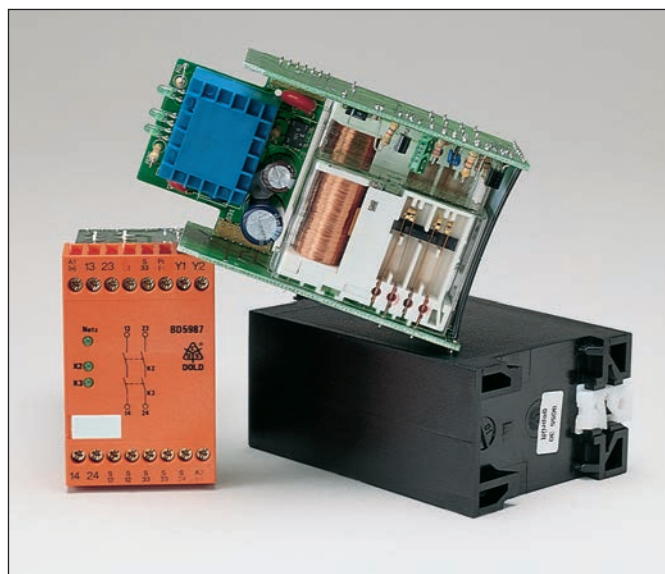

## Typical Applications

- Emergency stop modules
- DIN Rail safety modules
- Safety door controls
- Two-hand operating devices
- Pressure mat controls
- Light barriers and curtains
- Speed controls
- Monitoring devices

## Equipment controls systems for:

- Elevators and escalators
- Cranes
- Door and gate drive systems
- Printing and textile machinery
- Robots
- Stamping machines
- Medical equipment
- Cutting machines
- Rail transportation systems
- Signaling systems
- Press systems

### WARNING

**Improper** use and installation of safety relays - modules into safety related circuitry without complying with the applicable regulations can cause serious injury to the operator.

**Due** to the wide range of potential users and customers’ interpretation of the standards covering the applications of the safety relays described in this brochure, it is impossible for DOLD personnel or sales agents to be familiar with all safety and health standards and requirements that may apply to any specific application.

**It** is the responsibility of the user to determine the suitability of a safety relay for the intended application and to determine that the safety relay chosen and its installation will comply with all applicable safety and health regulations and codes.

# Relay Terminology

**Ambient Temperature:** The temperature of the surrounding medium that comes in contact with the device/ equipment.

**Breakdown Voltage:** The minimum root-mean-square (rms) value of a sinusoidal voltage that results in sparkover.

**Coil, relay:** One or more windings on a common form.

**Coil Power Dissipation:** The amount of electric power consumed by a winding. For the most practical purpose, this equals the  $I^2R$  loss.

**Coil Resistance:** The total terminal-to-terminal resistance of a coil at a specified temperature.

**Contact Gap:** The final length of the isolating distance between mating contacts when the contacts are open.

**Contact Arrangement:** The combination of contact forms that make up the entire relay switching structure.

**Contact Housing:** The part that provides means for mounting fixed contacts on a supporting structure.

**Contact Material:** Substance or combination of substances used as constituents in the manufacture of the contacts.

**AgSnO<sub>2</sub> + 0.2μmAu:** Silver-Tin Dioxide with a 0.2μ layer of gold. Medium to high current applications for resistive, capacitive and particular inductive loads, 100mA-10A.

**AgNi10+ 0.2μmAu:** Silver-Nickel 10 with a 0.2μ layer of gold. Medium to high current applications, 15mA-10A.

**AgNi10+ 5μmAu:** Silver-Nickel 10 with a 5μ layer of gold. Low current applications only, where switching of very low current is crucial; 1mA-300mA, 100mV-60V.

**Contact Pressure:** Force exerted by one contact against the mating contact of a relay.

**Contact Switching Rate:** The velocity at which contact switching occurs, e.g., 10 switching operations per second.

**Corrosion:** The deterioration of a substance, usually a metal, because of a reaction with its environment.

**Cover Material:** Substance or combination of substances used as constituents in the manufacture of a protective covering used to enclose equipment.

**Creeping Distance:** The shortest distance between two conducting parts measured along the surface or joints of the insulating material between them.

## Safety Relay Selection Material Table

| Material                                 | Characteristics   | Applications  | Range       |
|--|---|---|-------------|
| AgSnO <sub>2</sub> + 0.2μmAu<br><b>C</b> | very low welding tendency<br>highest burn-up resistivity<br>very good arc suppression | special for switching,<br>inductive loads                                 | 100mA - 10A |
| AgNi10 + 0.2μmAu<br><b>N</b>             | low welding tendency<br>high burn-up resistivity<br>good arc suppression              | circuits with medium to<br>high switching current,<br>DC current circuits | 15mA - 10A  |
| AgNi10 + 5μmAu<br><b>S</b>               | higher welding tendency<br>low burn-up resistivity<br>low contact resistance          | where very low to medium<br>switching current and<br>voltage is mandatory | 1mA - 300mA |

**Crown Contacts:** Improved contact form to enforce high contact stress on at least two spots on the contact to penetrate any built-up contamination; to maintain low contact resistance throughout the life of a relay; and to increase the value of switchable output voltage. Supports low current to high power applications.

**Custom Design:** Special design to meet customer requirements regarding coil voltage, coil resistance, contact pressure, and relay operate/release time. Possible alteration of max. 3 specifications from the original standard value while the remaining 1 is retained at its original value.

## Graphic Symbols

| Contact Name    | Short Form       | DIN / IEC Symbol | UL / CSA Symbol |
|-----------------|------------------|------------------|-----------------|
| Normally Open   | NO, Form A       |                  |                 |
| Normally Closed | NC, Form B       |                  |                 |
| Changeover      | CO, Form C, SPDT |                  |                 |

**Forced-Guided Contacts:** Electro-mechanical relay contacts that are mechanically linked together, so that when the relay coil is energized or de-energized, all of the linked contacts move together. If one set of contacts in the relay becomes immobilized, no other contact of the same relay will be able to move. An open-contact gap > 0.5 mm ( 0.02 in.) is maintained during life of the relay, even with malfunction, and at 1.6 x Nominal Voltage. Forced-Guided contacts are also known as captive contacts, positive-guided contacts, or locked contacts. They are used in Safety Relays.

# Relay Terminology

## Forced-Guided versus Standard Relay Contacts

### Forced-Guided Relay Contacts

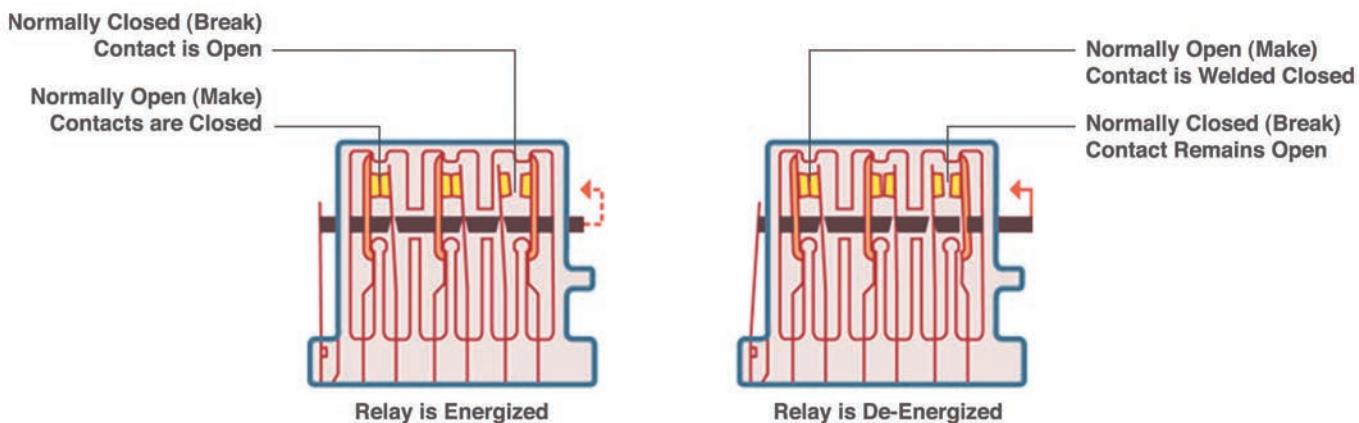

### Standard Relay Contacts

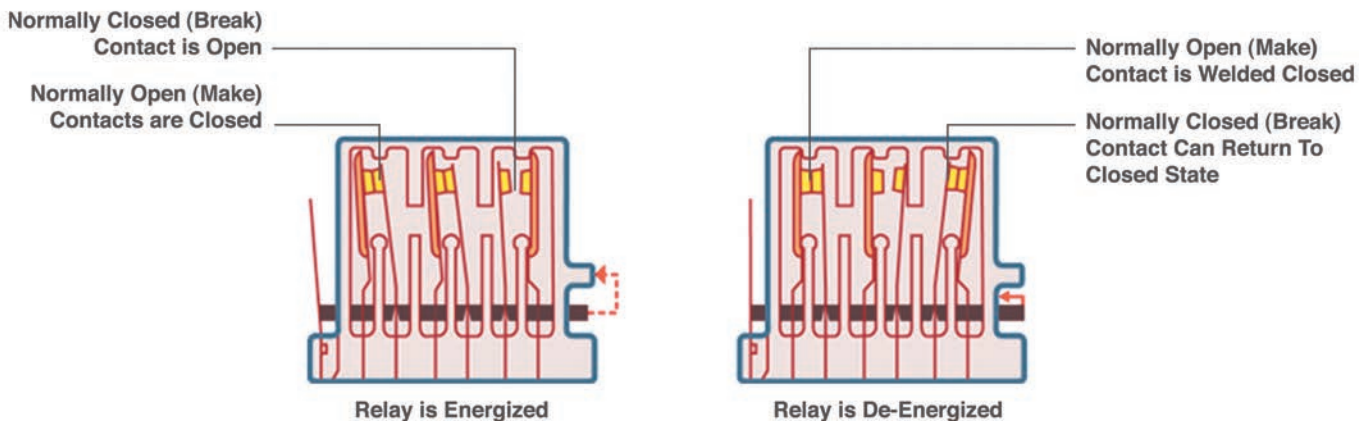

# Relay Terminology

**Flash-Plated:** Thin gold coating of the relay contacts to prevent corrosion during shelf-life (long-time storage).

**Mechanical Life:** Number of expected operation cycles of the relay contacts.

**Mixed Contact Material:** Pertaining to a safety relay on which each single contact can be made of different material, e.g., 6 pole safety relay: 4 n/o contacts made of  $\text{AgSnO}_2 + 0.2\mu\text{mAu}$  and 2 n/c contacts made of  $\text{AgNi } 10 + 5\mu\text{mAu}$ .

**Normally Closed Contact (NC):** A relay contact pair that is closed when the coil is not energized.

**Normally Open Contact (NO):** A relay contact pair that is open when the coil is not energized.

**Nominal Coil Voltage:** The voltage by which the coil is designated and to which certain operating characteristics of the relay are related.

**Operating Voltage:** The voltage by which the relay performs to the desired function.

**Pin Diagram:** A diagram of the points at which a connection is made between the relay and the circuit board.

**Protection Rating:** Classification system for the sealing effectiveness of electrical equipment to protect against foreign bodies. In a two digit code, the first digit indicates the protection against solid objects, while the second indicates protection from moisture.

**International Protection (IP, according to IEC 529):** Protection against a process whereby unwanted material enter the relay to occupy space that would otherwise remain free of such material.

**IP 40, First digit 4:** Protection from entry by solid objects with a diameter greater than 1.0 mm.  
Second digit 0: no special protection against moisture

**IP 67, First digit 6:** Dust-tight.  
Second digit 7: Protection against immersion.

**Relay Operate Time:** The time interval from coil energization to the functioning time of the last contact to function.

**Relay Release Time:** The time interval from coil de-energization to the functioning time of the last contact to function.

**Safety Relay:** An electro-mechanical relay with forced-guided contacts used in Safety Devices such as Emergency Stop Modules, Safety Gate Monitors, 2-Hand Safety Modules, Safety Light Curtains, etc.



**Switching Current:** The value of the root-mean-square (rms) symmetrical current expressed in amperes, which the relay output contact interrupts at the rated maximum voltage and rated frequency.

**Switching Power:** The value of the product of switching voltage x switching current, which the relay output contact interrupts under certain test conditions.

**Switching Voltage:** The value of the voltage expressed in volt, which the relay output contact interrupts at the rated maximum current and rated frequency.

**Voltage Range:** The region between the lower and upper limits in regards of the Nominal Coil Voltage.

**Washable:** A sealed construction allows automatic washing and cleaning of the PC board.

**Part Number .....Page**

156.OA01. C .....28-29  
 156.OA02. C .....30-31  
 156.OA11. C .....28-29  
 156.OA12. C .....30-31  
 256.OA01. C .....28-29  
 256.OA02. C .....30-31  
 256.OA11. C .....28-29  
 256.OA12. C .....30-31  
 456.OA01. C .....28-29  
 456.OA02. C .....30-31  
 456.OA11. C .....28-29  
 456.OA12. C .....30-31  
 56.5601.01.....32  
 56.5601.10.....32  
 56.5602.02.....32  
 56.5602.20.....32  
 56.5603.03.....32  
 56.5611.11.....32  
 56.5612.12.....32  
 56.5621.21.....32  
 56.5622.22.....32  
 56.5669.00.....32  
 56.5669.99.....32  
 56.5669.DR .....32  
 56.5669.GR .....32  
 56.5669.RE.....32  
 56.OA01. C .....20-21  
 56.OA01. N .....20-21  
 56.OA01. S .....20-21  
 56.OA02. C .....22-23  
 56.OA02. N .....22-23  
 56.OA02. S .....22-23  
 56.OA03. C .....24-25  
 56.OA03. N .....24-25  
 56.OA03. S .....24-25  
 56.OA11. C .....16-17  
 56.OA11. N .....16-17  
 56.OA11. S .....16-17  
 56.OA12. C .....18-19  
 56.OA12. N .....18-19  
 56.OA12. S .....18-19  
 56.OA21. C .....10-11  
 56.OA21. N .....10-11  
 56.OA21. S .....10-11  
 56.OA21S. C .....10-11  
 56.OA21S. N .....10-11  
 56.OA21S. S .....10-11  
 56.OA22. C .....12-13  
 56.OA22. N .....12-13  
 56.OA22. S .....12-13  
 56.OA22S. C .....12-13  
 56.OA22S. N .....12-13  
 56.OA22S. S .....12-13

**Part Number .....Page**

56.OA42. C .....4-5  
 56.OA42. N .....4-5  
 56.OA42. S .....4-5  
 56.OA43. C .....4-5  
 56.OA43. N .....4-5  
 56.OA43. S .....4-5  
 56.OA44. C .....4-5  
 56.OA44. N .....4-5  
 56.OA44. S .....4-5  
 56.OA67. C .....14-15  
 56.OA67. N .....14-15  
 56.OA67. S .....14-15  
 56.OA67S. C .....14-15  
 56.OA67S. N .....14-15  
 56.OA67S. S .....14-15  
 56.OA69. C .....6-7  
 56.OA69. N .....6-7  
 56.OA69. S .....6-7  
 56.OA70. C .....8-9  
 56.OA70. N .....8-9  
 56.OA70. S .....8-9  
 56.OW69. C .....6-7  
 56.OW69. N .....6-7  
 56.OW69. S .....6-7  
 56.OW70. C .....8-9  
 56.OW70. N .....8-9  
 56.OW70. S .....8-9  
 8923.2C .....26-27  
 8923.2N .....26-27  
 8923.2S .....26-27  
 8923.3C .....26-27  
 8923.3N .....26-27  
 8923.3S .....26-27  
 8924.2C .....26-27  
 8924.2N .....26-27  
 8924.2S .....26-27  
 8924.4C .....26-27  
 8924.4N .....26-27  
 8924.4S .....26-27  
 8926.2C .....26-27  
 8926.2N .....26-27  
 8926.2S .....26-27  
 8926.3C .....26-27  
 8926.3N .....26-27  
 8926.3S .....26-27  
 8927.2C .....26-27  
 8927.2N .....26-27  
 8927.2S .....26-27  
 8927.3C .....26-27  
 8927.3N .....26-27  
 8927.3S .....26-27  
 8949.2C .....26-27  
 8949.2N .....26-27

**Part Number .....Page**

8949.2S .....26-27  
 8949.3C .....26-27  
 8949.3N .....26-27  
 8949.3S .....26-27  
 8951.2C .....26-27  
 8951.2N .....26-27  
 8951.2S .....26-27  
 8951.3C .....26-27  
 8951.3N .....26-27  
 8951.3S .....26-27  
 8955.2C .....26-27  
 8955.2N .....26-27  
 8955.2S .....26-27  
 8955.3C .....26-27  
 8955.3N .....26-27  
 8955.3S .....26-27  
 8956.2C .....26-27  
 8956.2N .....26-27  
 8956.2S .....26-27  
 8956.3C .....26-27  
 8956.3N .....26-27  
 8956.3S .....26-27  
 8963.2C .....26-27  
 8963.2N .....26-27  
 8963.2S .....26-27  
 8972.2C .....26-27  
 8972.2N .....26-27  
 8972.2S .....26-27



# Here are other great catalogs available from Altech!

## Circuit Protection Devices



Altech carries DIN Rail mounted UL508 Manual Motor Controllers/ Miniature Circuit Breakers, UL489 Miniature Circuit Breakers and UL1077 Supplementary Protectors. The UL489 versions are 17.5mm wide, thermal magnetic, 240V, 480Y/277V AC, 50/60Hz, 125 and 250 VDC models, with short circuit interrupt capacity of 10kA, a positive trip indicator, and are line/load reversible. The UL1077 versions are DIN rail mounted, 17.5mm wide, thermal magnetic, 480Y/277V AC, 50/60Hz, a short circuit withstand capacity 10kA, have a positive trip indicator.

**Altech Corp.®**  
 35 Royal Rd., Flemington, NJ 08822  
 908-806-9400  
 FAX 908-806-9490  
[www.altechcorp.com](http://www.altechcorp.com)

## Interface Modules and Power Supplies

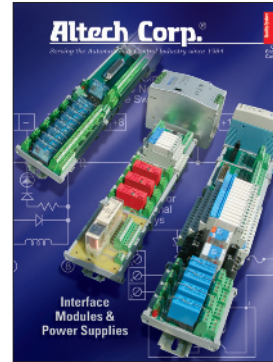

Altech offers a wide range of DIN Rail or panel mount cable interface modules, relay interface modules, power supplies, carrier modules, and custom designed modules. Cable to connector models include: D-Sub connectors, ribbon cable connectors, and Dip socket connectors to terminals. Standard relay modules from 1 to 16 channels, and safety relay modules from 1 to 16 channels and up to 10 poles are included. The catalog also contains switching power supplies, linear power supplies, and custom designed interface modules.

**Altech Corp.®**  
 35 Royal Rd., Flemington, NJ 08822  
 908-806-9400  
 FAX 908-806-9490  
[www.altechcorp.com](http://www.altechcorp.com)

## Contactors and More!



Altech's now carries contactors, mini contactors, definite purpose contactors & overload relays. The contactors come in 3 and 4 pole configurations at 9A to 800A. Available in Single Phase (115 -230V) and Three Phase (200 - 575V) AC and DC models. A large variety of coil voltages are supported and the accessories are auxiliary contacts and overload relays. The mini contactors come in screw clamp, fast-on, cage clamp and solder pin types.

**Altech Corp.®**  
 35 Royal Rd., Flemington, NJ 08822  
 908-806-9400  
 FAX 908-806-9490  
[www.altechcorp.com](http://www.altechcorp.com)

## DIN Enclosures

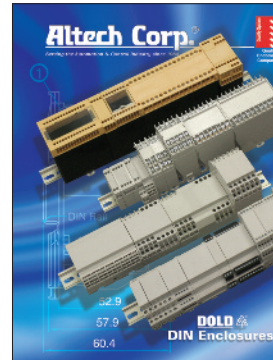

Our catalog features many new models plus our current six distinct DIN Rail mount enclosure families with a multitude of sizes and features. Internationally accepted, these enclosures are offered complete with up to 144 ready-to-wire terminals, integral PC Board guides and a selection of terminal-to-board connection options. They can be customized with imprints, markings, cutouts, etc. and snap onto standard 35mm DIN Rails or can be panel mounted. The catalog is complete with technical drawings to assist you in your designs.

**Altech Corp.®**  
 35 Royal Rd., Flemington, NJ 08822  
 908-806-9400  
 FAX 908-806-9490  
[www.altechcorp.com](http://www.altechcorp.com)

## Industrial Enclosures



Altech's expanded its line of TK Industrial Enclosures with metric knockouts and also added the versatile TG Enclosure series. Now our entire line of industrial enclosures is in metric. Metric knockouts align with international standards making selection easier and more universal. Plus the PG standard is still available. All of Altech's enclosures are internationally accepted and stand up to the harshest environments. They protect against dust, water and corrosion while enhancing the value of your product. Rated up to IP66 (NEMA type 4x), Altech enclosures are available in a wide range of sizes.

**Altech Corp.®**  
 35 Royal Rd., Flemington, NJ 08822  
 908-806-9400  
 FAX 908-806-9490  
[www.altechcorp.com](http://www.altechcorp.com)

## Liquid Tight Strain Reliefs



This 50-page catalog introduces Altech's full line of Liquid Tight Strain Reliefs (Cord Grips) which are used to seal cable entries, keep contaminants from entering enclosures, provide strain relief and thus reduce stress on components and termination points inside enclosures. Functions include Straight-Through, Increased Strain Relief, Bend Protection, Pull/Bend Protection, Multi-conductor, Flat Cable, Atex and EMI/RFI. They can be used with almost any type of cable, cord or conductor - solid, stranded, flat, shielded, high temperature, etc.

**Altech Corp.®**  
 35 Royal Rd., Flemington, NJ 08822  
 908-806-9400  
 FAX 908-806-9490  
[www.altechcorp.com](http://www.altechcorp.com)

## DIN Rail Power Supplies



Altech DIN RAIL mountable power supplies have Universal AC input. They are suitable for industrial and automation applications.

- UL508 Listed
- Installed on DIN rail TS35/ 7.5 or 15
- Available from 30-960W
- Protections: Short circuit / Overload / Over-voltage / Over temperature
- Cooling by free air convection
- Worldwide approvals
- 3 year warranty

**Altech Corp.®**  
 35 Royal Rd., Flemington, NJ 08822  
 908-806-9400  
 FAX 908-806-9490  
[www.altechcorp.com](http://www.altechcorp.com)

## Motor Disconnect Switches



Altech's line of Motor Disconnect Switches are UL 508 listed as Manual Motor Controllers for AC Motor Starting Across-the-line and AC General use. This new 24 page catalog includes the 3 different handle designs, which are all available in gray/black or yellow/red housings. Electrical ratings are 25-150A / 600V. The switches are non-fused DIN Rail mountable. Neat features include: snap-on auxiliary switches, door mounting kit and a retrofit 30A fuse holder. Also featured are Enclosed Motor Disconnect Switches & Fused (plastic only) versions (30A), available in plastic, aluminum, sheet metal or stainless steel.

**Altech Corp.®**  
 35 Royal Rd., Flemington, NJ 08822  
 908-806-9400 • FAX 908-806-9490  
[www.altechcorp.com](http://www.altechcorp.com)