



GE SERIES

HIGH PERFORMANCE IEC CONNECTOR FILTERS



INTRODUCTIONS

1. A high performance general purpose filter with an IEC connector providing effective EMI suppression.
2. Bleeder resistor can be added with suffix "-R" on part numbers, except "G3H", "G3V", "W3V", "G3J", "W3J", types.
3. All part numbers are UL recognized, CAS certified and VDE approved.
4. With optional Y-Cap from 100pF to 3300pF.

COMPONENTS

PART NO.	Cx (uF)	L (mH)	Cy (pF)	R (Ω)	
01GEEG3E/W3E/-R	0.1	6.5	2200	1M	
01GEEG3H/G3V/W3V		3	3300	-	
01GEEG3S/-R		10.5	-	-	
03GEEG3E/W3E/W3ES/-R		2.5	2.2	2200	1M
03GEEG3U/-R				-	-
•03GEEW3ES/-R		4	2.4	3300	-
03GEEG3H/G3V/W3V				-	-
03GEEG3S/-R		2.4	2.2	1M	-
•03GEEG3Q/W3Q-R				-	-
03GEEW3J		0.8	2.2	2200	-
03GEHG3J				-	-
06GEEG3E/W3E/W3ES/-R		1.05	0.2	2200	1M
06GEEG3U/-R				-	-
06GEEG3H/G3V/W3V		1.5	0.3	3300	-
06GEEG3S/-R				-	-
••06GEEG3Q/W3Q-R		0.4	0.2	2200	1M
•••10GEEG3C/W3C/-R				-	-
10GEEG3E/W3E/W3ES/-R		0.2	0.3	2200	1M
10GEEG3S/-R				-	-
*10GEEG3Q/W3Q-R		0.2	0.3	2200	1M
10GEEG3U/-R	-			-	
**15GEEG3E/W3E/-R	0.2	0.3	2200	1M	
***20GEEG3E/W3E/-R	0.3	0.3	2200	1M	

- UL, CSA approved to 4A 115/250V
- UL, CSA approved to 8A 115/250V
- VDE approved to 8A/250V
- * UL, CSA approved to 13A 115/250V
- ** VDE approved to 10A/250V
- *** VDE approved to 16A/250V

SPECIFICATIONS

1. Maximum leakage current each line-to-ground @ 115VAC 60Hz: 0.25mA @ 250VAC 50Hz: 0.45mA
2. Hipot rating (one minute) line-to-ground: 2250VDC line-to-line: 1450VDC
3. Operating frequency: 50/60Hz
4. Rated voltage: 115/250VAC

ELECTRICAL SCHEMATIC

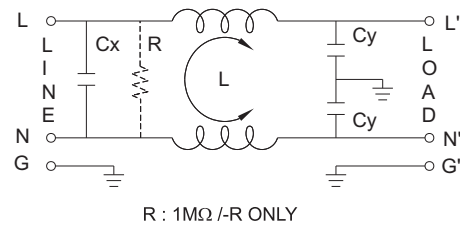

INSERTION LOSS (TYPICAL)

03GEEG3E ----- COMMON MODE ----- DIFF. MODE
 06GEEG3E ----- COMMON MODE ----- DIFF. MODE

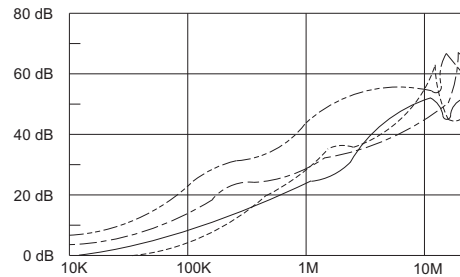

20GEEG3E ----- COMMON MODE ----- DIFF. MODE

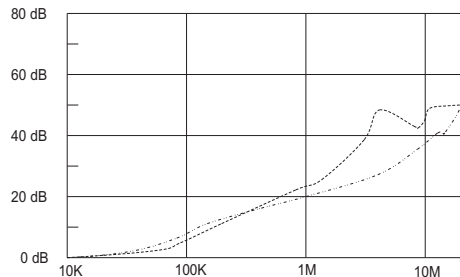

MINIMUM INSERTION LOSS IN dB

CURRENT RATING	COMMON MODE (L-G) IN 50 OHM SYSTEM					
	FREQUENCY-MHz					
	.15	.50	1.0	5.0	10	30
1A(E)(S)	28	35	38	38	40	40
1A(H)	26	36	44	54	55	55
1A(G3V)	24	35	42	50	55	55
1A(W3V)	24	35	42	50	55	55
3A(E)(S)(Q)	20	25	30	38	40	40
3A(H)	24	30	38	50	55	40
3A(G3J,W3J)	20	25	30	38	40	40
3A(G3V)(W3V)	20	29	36	48	46	50
6A(E)(S)	12	18	24	35	40	40
6A(H)	15	25	28	35	45	45
6A(Q)	15	20	24	35	40	55
6A(G3V)(W3V)	14	23	30	42	45	50
10A(E)(S)	4	10	13	28	35	40
10A(C)	10	15	15	25	30	35
10A(Q)	10	12	15	30	32	45
15A(E)	4	10	13	28	35	40
20A	8	10	15	25	30	35

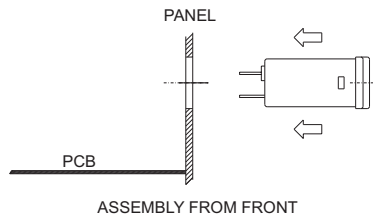

MECHANICAL CONSTRUCTION



EG3E, EG3Q (Optional soldering lug or wire type)

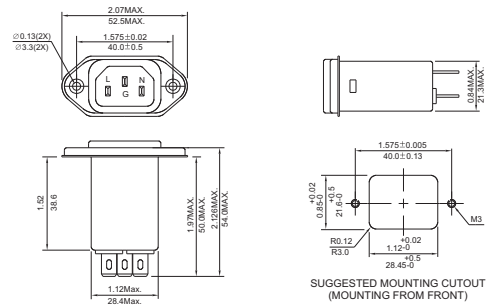

EG3S

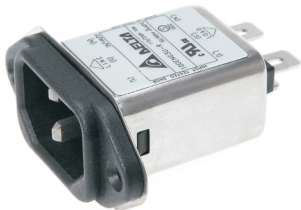
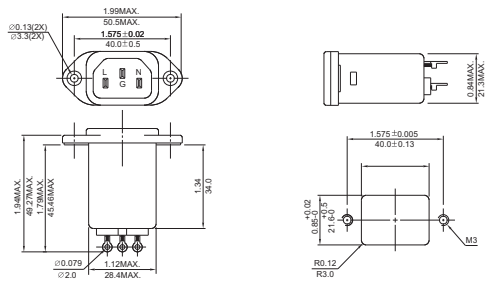

EG3U (With Compact Size)

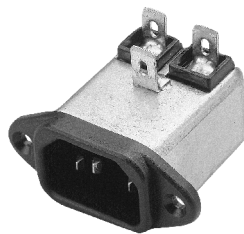
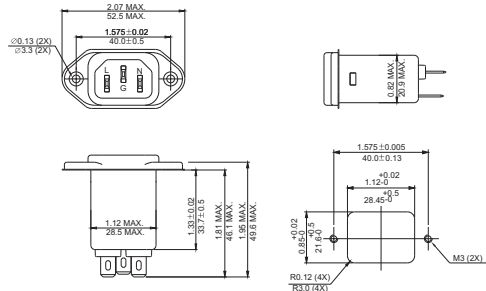

EG3V

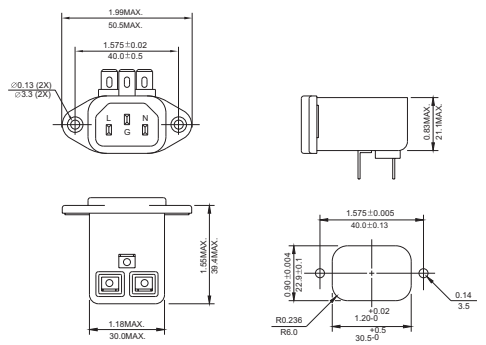

EW3V

