

## Description

Very cost effective design to meet international requirements. No exposed metal parts which are, or could become, current-carrying except for terminals. R-type TO CBE to EN 60934.

- Manual reset, cycling trip free mechanism
- Extremely small and lightweight
- UL, CSA, VDE and EN 60934 (IEC 60934) approved

## Typical applications

Battery chargers, consumer products, power supplies, motors.

## Ordering information

### Type No.

1658 single pole thermal circuit breaker

#### Threadneck design

**G21** manual reset type, 3/8"-27 threadneck

**G41** manual reset type, 7/16"-28 threadneck

**A21** auto reset type, 3/8"-27 threadneck

**A41** auto reset type, 7/16"-28 threadneck

**A00** auto reset type, without threadneck

**F01** snap in

#### Hardware

**00** no hardware

**01** one PAL nut, bulk

**02** one PAL nut, one knurled nut, bulk

**03** one PAL nut mounted

**04** one PAL nut, one knurled nut, mounted

**05** one PAL nut mounted, one knurled nut, bulk

**06** one knurled nut, bulk

**07** one hex nut, bulk

**08** two hex nuts, bulk

#### Terminals

**P10** blade terminals A6.3-0.8 (QC .250)

**P13** blade terminals A6.3-0.8 (QC .250), 90°

**S80** straight screw terminals\*

**S83** 90° bent screw terminals\*

#### Current ratings

5...30 A

1658 - G21 - 02 - P10 - 5 A Ordering example

\* Screws and lock washers bulk shipped

## Standard current ratings and typical voltage drop values

| Current rating (A) | Voltage drop (mV) | Current rating (A) | Voltage drop (mV) |
|--------------------|-------------------|--------------------|-------------------|
| 5                  | ≤ 250             | 12                 | ≤ 250             |
| 6                  | ≤ 250             | 15                 | ≤ 250             |
| 7                  | ≤ 250             | 16                 | ≤ 250             |
| 8                  | ≤ 250             | 20                 | ≤ 250             |
| 9                  | ≤ 250             | 25                 | ≤ 250             |
| 10                 | ≤ 250             | 30                 | ≤ 250             |

## Approvals

| Authority      | Voltage rating    | Current ratings        |
|----------------|-------------------|------------------------|
| VDE (EN 60934) | AC 240 V; DC 28 V | 5...25 A               |
| UL             | AC 240 V          | 5...16 A 1658-G../F..  |
|                | AC 120 V          | 18...30 A 1658-G../F.. |
|                | AC 120 V          | 5...30 A 1658-A...     |
|                | DC 32 V           | 5...30 A 1658-G../F..  |
|                | DC 28 V           | 5...30 A 1658-A..      |



1658-...

## Technical data

For further details please see chapter: Technical Information

|   |   |  |                    |
|---|---|--|--------------------|
| Voltage rating  | AC 240 V; DC 28 V   |  |                    |
| Current ratings   | 5...30 A  |  |                    |
| Typical life  | AC + DC 5...16 A  | 1,000 operations at 2 x I <sub>N</sub> , inductive |                    |
|   | 17...25 A   | 1,000 operations at 2 x I <sub>N</sub> , resistive |                    |
| Ambient temperature   | -20...+60 °C (-4...+140 °F),<br>≤ 7 A max. +40 °C (+104 °F)                                     |  |                    |
| Insulation co-ordination<br>(IEC 60664 and 60664 A)             | rated impulse withstand voltage   | 2.5 kV   | pollution degree 2 |
|   | reinforced insulation in operating area   |  |                    |
| Dielectric strength<br>(IEC 60664 and 60664A)<br>operating area | test voltage  | AC 3,000 V   |                    |
|   | > 100 MΩ (DC 500 V)   |  |                    |
| Interrupting capacity I <sub>cn</sub>                           | 5...7 A   | 180 A  |                    |
|   | 8...30 A  | 200 A  |                    |
| Interrupting capacity<br>(UL 1077/EN 60934 PC1)                 | I <sub>N</sub> 5...16 A   | U <sub>N</sub> AC 240 V                            | 2,000 A            |
|   | 17...30 A   | AC 120 V   | 2,000 A            |
|   | 5...30 A  | DC 32 V  | 2,500 A            |
|   | 5...30 A  | DC 28 V  | 2,000 A (1658-A..) |
| Degree of protection<br>(IEC 60529/DIN 40050)                   | operating area IP40   |  |                    |
|   | terminal area IP00  |  |                    |
| Vibration   | 8 g (57-500 Hz) ± 0.61 mm (10-57 Hz),<br>to IEC 60068-2-6, test Fc,<br>10 frequency cycles/axis |  |                    |
| Shock   | 30 g (11 ms)<br>to IEC 60068-2-27, test Ea  |  |                    |
| Corrosion   | 96 hours at 5 % salt mist,<br>to IEC 60068-2-11, test Ka  |  |                    |
| Humidity  | 240 hours at 95 % RH<br>to IEC 60068-2-78, test Cab   |  |                    |
| Mass  | approx. 16 g  |  |                    |

## Dimensions

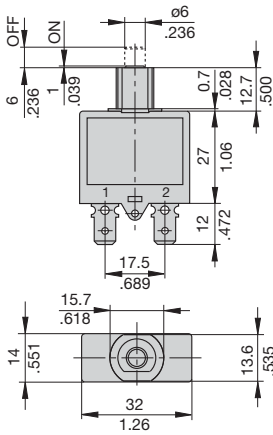

**A00**



**A21** tightening torque max. 0.8 Nm  
3/8-27UNS-2A

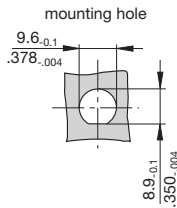
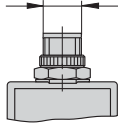

**G21** tightening torque max. 0.8 Nm  
3/8-27UNS-2A

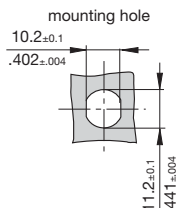
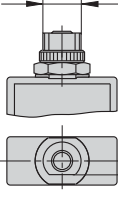

**A41**

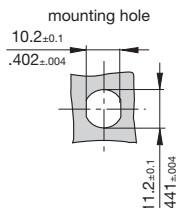
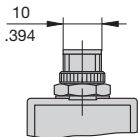

**G41**

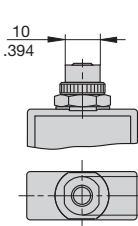

7/16-28UNS-2A  
double "D"  
tightening torque max. 0.8 Nm

**F01**

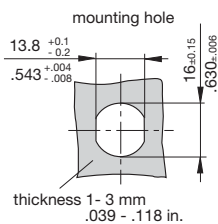
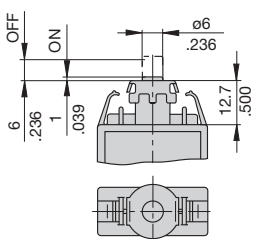

Caution:  
Please keep a tight grip on the unit  
while removing the female connectors.

See ordering information for mounting hardware.

## Terminal design

**P10**

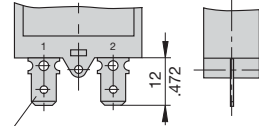

blade terminals DIN 46244-A6.3-0.8  
(QC .250)

**S83**

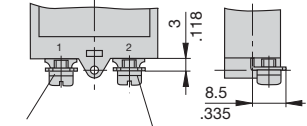

terminal screw  
6-32 UNC lock washer

**P13**

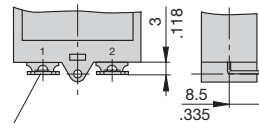

blade terminals DIN 46244-A6.3-0.8 (QC .250)  
angled 90°

**P10-S83**

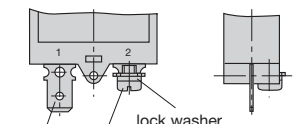

terminal screw  
6-32 UNC lock washer

**S80**

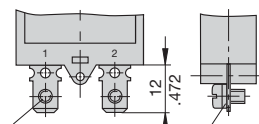

terminal screw  
6-32 UNC lock washer

blade terminals  
DIN 46244-A6.3-0.8 (QC .250)

## Installation drawing

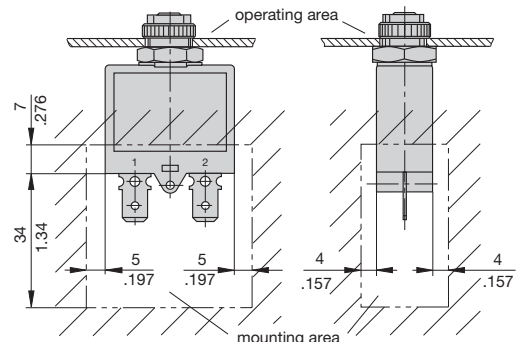

This is a metric design and millimeter dimensions take precedence ( $\frac{\text{mm}}{\text{inch}}$ )

## Internal connection diagram

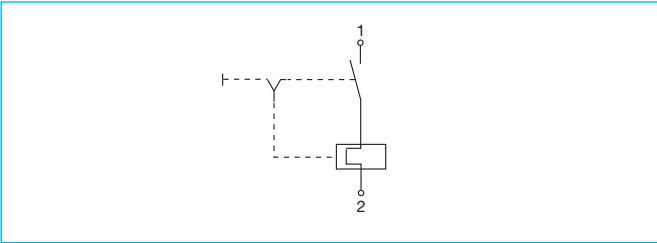

## Typical time/current characteristics

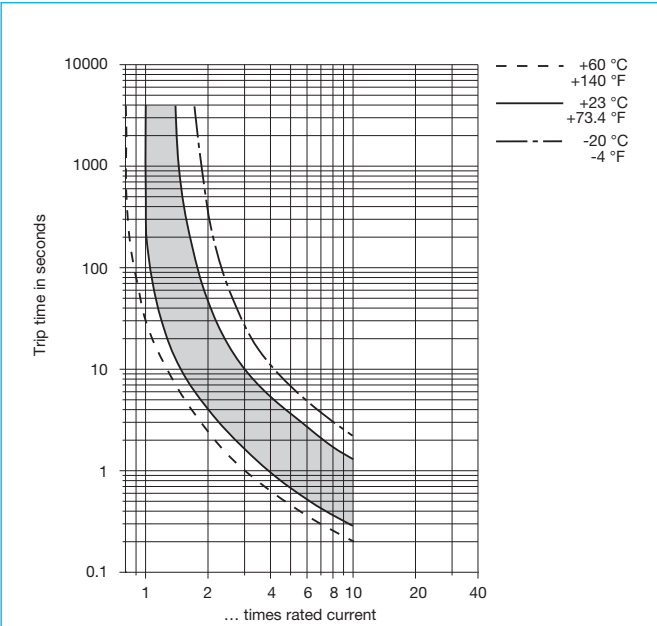

The time/current characteristic curve depends on the ambient temperature prevailing. In order to eliminate nuisance tripping, please multiply the circuit breaker current ratings by the derating factor shown below. See also section Technical information.

| Ambient temperature °F     | -4   | +14  | +32  | +73.4 | +104 | +122 | +140 |
|----------------------------|------|------|------|-------|------|------|------|
| °C                         | -20  | -10  | 0    | +23   | +40  | +50  | +60  |
| Derating factor $I_N > 7A$ | 0.83 | 0.85 | 0.9  | 1     | 1.1  | 1.18 | 1.25 |
| $I_N \leq 7A$              | 0.74 | 0.76 | 0.82 | 1     | 1.23 | -    | -    |

## Accessories

**Mounting nut 3/8", 27-thread**  
Y 306 671 01

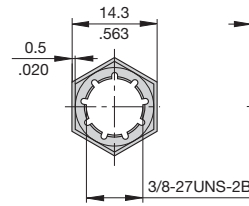

**Mounting nut 7/16", 28-thread**  
Y 303 200 01

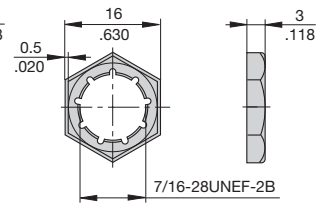

**Knurled nut 3/8", 27-thread plastic (standard)**  
Y 307 117 02

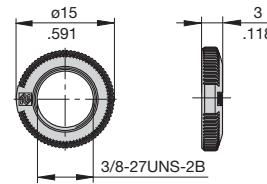

**Knurled nut 7/16", 28-thread nickel-plated brass**  
Y 302 294 03

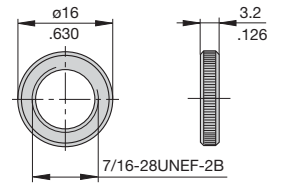

**Knurled nut 3/8", 27-thread nickel-plated brass**  
Y 300 190 03

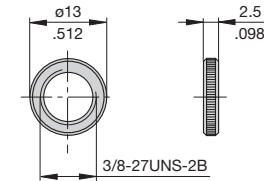

**Hex nut 3/8", 27-thread nickel-plated brass**  
Y 300 192 01

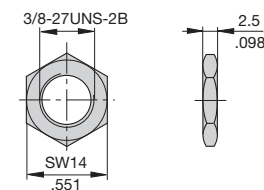

**Hex nut 7/16", 28-thread nickel-plated brass**  
Y 302 295 01

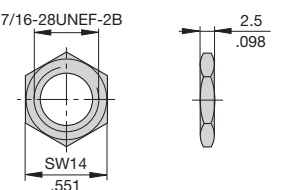

**Press to Reset Plate for 3/8" thread, aluminium**  
Y 301 059 02

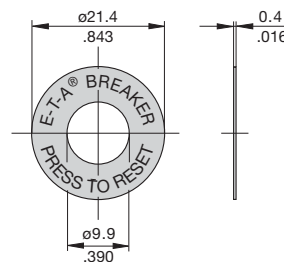

**Press to Reset Plate for 7/16" thread, aluminium**  
Y 302 732 01

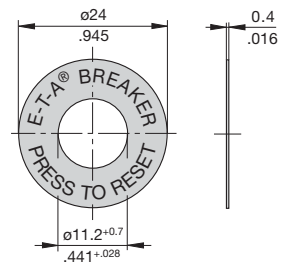

This is a metric design and millimeter dimensions take precedence (mm/inch)