

Description

Very cost effective design to meet international requirements. No exposed metal parts which are, or could become, current-carrying except for terminals. R-type TO CBE to EN 60934.

- Manual reset, cycling trip free mechanism
- Extremely small and lightweight
- UL, CSA, VDE and EN 60934 (IEC 60934) approved

Typical applications

Battery chargers, consumer products, power supplies, motors.

Ordering information

Type No.

1658 single pole thermal circuit breaker

Threadneck design

G21 manual reset type, 3/8"-27 threadneck

G41 manual reset type, 7/16"-28 threadneck

A21 auto reset type, 3/8"-27 threadneck

A41 auto reset type, 7/16"-28 threadneck

A00 auto reset type, without threadneck

F01 snap in

Hardware

00 no hardware

01 one PAL nut, bulk

02 one PAL nut, one knurled nut, bulk

03 one PAL nut mounted

04 one PAL nut, one knurled nut, mounted

05 one PAL nut mounted, one knurled nut, bulk

06 one knurled nut, bulk

07 one hex nut, bulk

08 two hex nuts, bulk

Terminals

P10 blade terminals A6.3-0.8 (QC .250)

P13 blade terminals A6.3-0.8 (QC .250), 90°

S80 straight screw terminals*

S83 90° bent screw terminals*

Current ratings

5...30 A

1658 - G21 - 02 - P10 - 5 A Ordering example

* Screws and lock washers bulk shipped

Standard current ratings and typical voltage drop values

Current rating (A)	Voltage drop (mV)	Current rating (A)	Voltage drop (mV)
5	≤ 250	12	≤ 250
6	≤ 250	15	≤ 250
7	≤ 250	16	≤ 250
8	≤ 250	20	≤ 250
9	≤ 250	25	≤ 250
10	≤ 250	30	≤ 250

Approvals

Authority	Voltage rating	Current ratings
VDE (EN 60934)	AC 240 V; DC 28 V	5...25 A
UL	AC 240 V	5...16 A 1658-G../F..
	AC 120 V	18...30 A 1658-G../F..
	AC 120 V	5...30 A 1658-A...
	DC 32 V	5...30 A 1658-G../F..
	DC 28 V	5...30 A 1658-A..



1658-...

Technical data

For further details please see chapter: Technical Information

Voltage rating	AC 240 V; DC 28 V		
Current ratings	5...30 A		
Typical life	AC + DC 5...16 A	1,000 operations at 2 x I _N , inductive	
	17...25 A	1,000 operations at 2 x I _N , resistive	
Ambient temperature	-20...+60 °C (-4...+140 °F), ≤ 7 A max. +40 °C (+104 °F)		
Insulation co-ordination (IEC 60664 and 60664 A)	rated impulse withstand voltage	2.5 kV	pollution degree 2
	reinforced insulation in operating area		
Dielectric strength (IEC 60664 and 60664A) operating area	test voltage	AC 3,000 V	
	> 100 MΩ (DC 500 V)		
Interrupting capacity I _{cn}	5...7 A	180 A	
	8...30 A	200 A	
Interrupting capacity (UL 1077/EN 60934 PC1)	I _N 5...16 A	U _N AC 240 V	2,000 A
	17...30 A	AC 120 V	2,000 A
	5...30 A	DC 32 V	2,500 A
	5...30 A	DC 28 V	2,000 A (1658-A..)
Degree of protection (IEC 60529/DIN 40050)	operating area IP40		
	terminal area IP00		
Vibration	8 g (57-500 Hz) ± 0.61 mm (10-57 Hz), to IEC 60068-2-6, test Fc, 10 frequency cycles/axis		
Shock	30 g (11 ms) to IEC 60068-2-27, test Ea		
Corrosion	96 hours at 5 % salt mist, to IEC 60068-2-11, test Ka		
Humidity	240 hours at 95 % RH to IEC 60068-2-78, test Cab		
Mass	approx. 16 g		

Dimensions

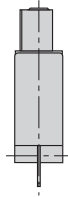

A00



A21

tightening torque max. 0.8 Nm
3/8-27UNS-2A

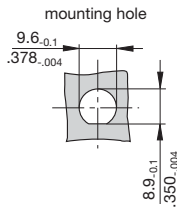
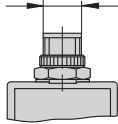

G21

tightening torque max. 0.8 Nm
3/8-27UNS-2A

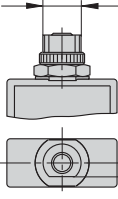

A41

10 / .394

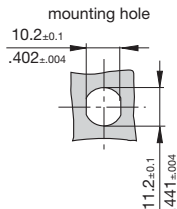
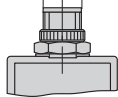

G41

10 / .394

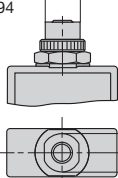

7/16-28UNS-2A
double "D"
tightening torque max. 0.8 Nm



F01

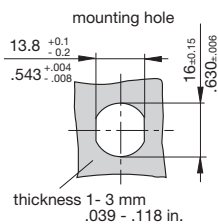
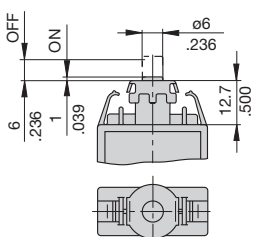

Caution:
Please keep a tight grip on the unit
while removing the female connectors.

See ordering information for mounting hardware.

Terminal design

P10

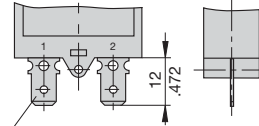

blade terminals DIN 46244-A6.3-0.8
(QC .250)

S83

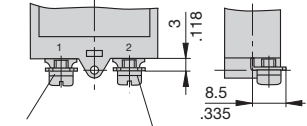

terminal screw
6-32 UNC
lock washer

P13

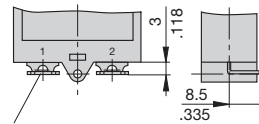

blade terminals DIN 46244-A6.3-0.8 (QC .250)
angled 90°

P10-S83

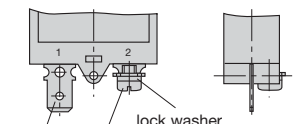

terminal screw
6-32 UNC
lock washer

S80

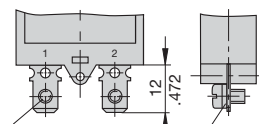

terminal screw
6-32 UNC
lock washer

blade terminals
DIN 46244-A6.3-0.8 (QC .250)

Installation drawing

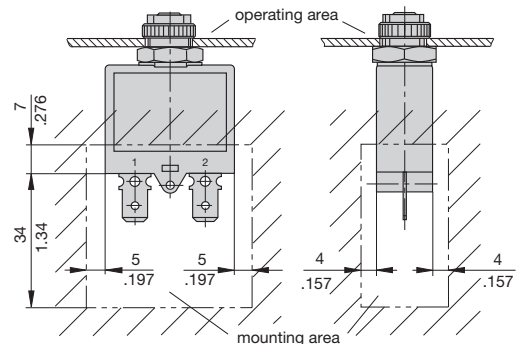

This is a metric design and millimeter dimensions take precedence (mm / inch)

Internal connection diagram



Typical time/current characteristics



The time/current characteristic curve depends on the ambient temperature prevailing. In order to eliminate nuisance tripping, please multiply the circuit breaker current ratings by the derating factor shown below. See also section Technical information.

Ambient temperature °F	-4	+14	+32	+73.4	+104	+122	+140
°C	-20	-10	0	+23	+40	+50	+60
Derating factor $I_N > 7A$	0.83	0.85	0.9	1	1.1	1.18	1.25
$I_N \leq 7A$	0.74	0.76	0.82	1	1.23	-	-

Accessories

Mounting nut 3/8", 27-thread
Y 306 671 01

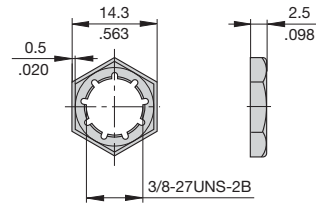

Mounting nut 7/16", 28-thread
Y 303 200 01

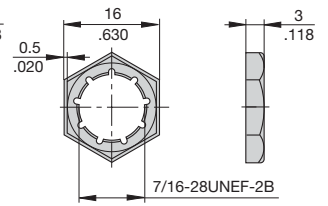

Knurled nut 3/8", 27-thread plastic (standard)
Y 307 117 02



Knurled nut 7/16", 28-thread nickel-plated brass
Y 302 294 03

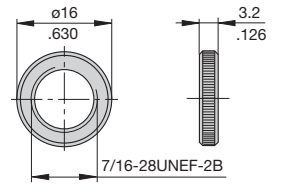

Knurled nut 3/8", 27-thread nickel-plated brass
Y 300 190 03

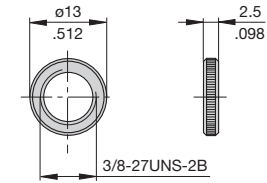

Hex nut 3/8", 27-thread nickel-plated brass
Y 300 192 01

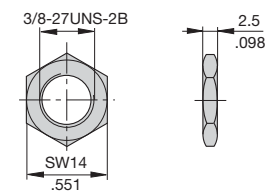

Hex nut 7/16", 28-thread nickel-plated brass
Y 302 295 01

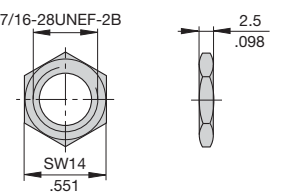

Press to Reset Plate for 3/8" thread, aluminium
Y 301 059 02

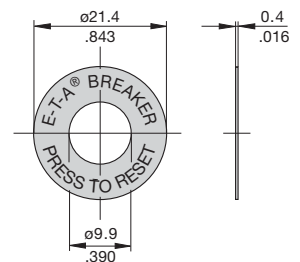

Press to Reset Plate for 7/16" thread, aluminium
Y 302 732 01



This is a metric design and millimeter dimensions take precedence (mm/inch)