



Cupcade: the Raspberry Pi Micro Arcade Cabinet

Created by Phillip Burgess



<https://learn.adafruit.com/cupcade-raspberry-pi-micro-mini-arcade-game-cabinet>

Last updated on 2021-11-15 06:09:55 PM EST

Table of Contents

Overview	5
• Current “Gen 3” Kit Contents:	6
• Optional additions:	6
• Prior “Gen 1” and “Gen 2” Kit Contents:	7
• Optional additions:	8
Plan Ahead	8
Prep Work	10
Raspberry Pi Setup	11
• SD Card Setup	11
• First Boot	12
• Enable WiFi (if needed)	14
• Download and Install Cupcade Software	15
• Additional Steps for GEN 3 KITS ONLY	18
• Additional Steps for GEN 1 & 2 KITS ONLY	19
• Last Steps for ALL Cupcade Versions	20
Gen 3 Kit	20
Assemble Components	21
• Buttons	22
• PiTFT Display	22
• Joystick	23
• Speaker	23
• Arcade Bonnet	24
Dry Run	25
• PiTFT Test	25
• If the PiTFT doesn’t work...	26
• Arcade Bonnet and Remaining Parts	26
• If the PiTFT Doesn’t Work Now	27
• If the PiTFT Does Work	28
• If the Buttons/Joystick Don’t Work	29
• If Sound Doesn’t Work	29
Cabinet Part 1	29
• Buttons	30
• Joystick	33
• Speaker	34
• Screen	34
• Base	36
• If using a Pi Zero...	39
Cabinet Part 2	39
Cabinet Part 3	42
• Okay, the Tricky Part...	44
Cabinet Part 4	48

Configure Input	51
Gen 2 Kit	54
Interface Board	56
Gen 1 Kit	59
Beta Board Part 1	61
Beta Board Part 2	69
• Arts & Crafts Time!	72
Beta Board Part 3	74
• Button Wires	75
• Joystick Wires	78
• Power Wires	80
• Audio Wires	81
• Soldering's done!	82
Gen 1 & 2 Continued...	83
PiTFT Assembly & Test	83
• Solder Time!	83
• If there's no response...	86
• Now a Second Test...	87
• Test ROM	88
Dry Run	88
• If the Pi Does Not Boot	91
• If the Pi Boots Successfully	92
• When You're Done Testing	93
Cabinet Part 1	93
Cabinet Part 2	101
• Joystick and Buttons	103
• Screen and Audio	104
Cabinet Part 3	105
• Okay, the Tricky Part	107
Cabinet Part 4	112
• If the system does not boot...	118
Installing ROMs	118
• Some Free MAME (Arcade) ROMs	118
• Moving ROMs Over the Network	119
Downloads	121
• Custom Cabinet Art	121
• Custom Cabinet	122
• PCB Files	123

Overview



A Maker Faire exhibit of mine once incorporated a Pac-Man theme “for the old-timers.” It was a surprise then to see young kids all recognized the characters too. How? Smartphones! Thanks to emulation — running old code byte-for-byte on modern hardware — these classic games are still played and relevant a generation later.

Much of the mystique of the originals lied in the cabinets and controls. Anyone can load a game on a smartphone or tablet...but the physicality of the arcade machine and its clicky buttons made them rare objects of desire back in the day. We wanted to capture a small taste of that, using the tiny Raspberry Pi computer. The result is a DIY kit we call Cupcade!

Cupcade isn't the first, but it's notable for using the Adafruit PiTFT display. The direct digital interface delivers a pixel-perfect rendition of classic games with none of the blurriness you'd get with a composite screen.

There have been MULTIPLE RELEASES of the Cupcade kit. This guide covers ALL of them. Some sections are common to all versions, others may be specific to one generation. The latest generation tends to be covered first, with prior generations as a follow-up.

Current “Gen 3” Kit Contents:

- [Adafruit PiTFT Plus 320x240 2.8" TFT screen](https://adafru.it/eZS) (<https://adafru.it/eZS>)
- [Analog joystick with breakout board](http://adafru.it/512) (<http://adafru.it/512>)
- [16mm Buttons](http://adafru.it/1445) (<http://adafru.it/1445>) (4)
- [Arcade Button Quick Connect Wires](http://adafru.it/1152) (<http://adafru.it/1152>) (4)
- [Female/female jumper wires](http://adafru.it/266) (<http://adafru.it/266>) (strip of 4)
- [Adafruit Arcade Bonnet for Raspberry Pi](https://adafru.it/Bh-) (<https://adafru.it/Bh->)
- [40-pin GPIO Ribbon Cable](https://adafru.it/Bi0) (<https://adafru.it/Bi0>)
- [GPIO Stacking Header](https://adafru.it/ejT) (<https://adafru.it/ejT>)
- [Mono Enclosed Speaker — 3W 4 Ohm](https://adafru.it/uyB) (<https://adafru.it/uyB>)
- Acrylic case parts (16)
- Nylon #4-40 screws and nuts (approx 25 each)
- Blank microSD card

You will also need:

- Raspberry Pi computer with 40-pin GPIO header, except for Pi 1 Model A+ or Pi 3 Model A+. Compatible boards include:
 - [Pi 3 Model B+](https://adafru.it/Bi1) (<https://adafru.it/Bi1>) (using RetroPie 4.4 or later)
 - [Pi 3 Model B](https://adafru.it/scY) (<https://adafru.it/scY>)
 - [Pi 2 Model B](https://adafru.it/eCB) (<https://adafru.it/eCB>)
 - [Pi 1 Model B+](https://adafru.it/dH0) (<https://adafru.it/dH0>)
 - [Pi Zero WH](https://adafru.it/Bi2) (<https://adafru.it/Bi2>)
 - [Pi Zero W](https://adafru.it/vMD) (<https://adafru.it/vMD>) (requires installing GPIO header pins)
 - [Pi Zero](https://adafru.it/sTA) (<https://adafru.it/sTA>) (requires installing GPIO header pins)
- Soldering iron, solder and related paraphernalia
- Masking tape
- Tiny screwdrivers
- For setup you will temporarily need a USB keyboard and HDMI monitor. Pi Zero boards will require adapters for both of these.
- Network connection to the Raspberry Pi board. Some models have WiFi built in, some can use Ethernet, others require a USB WiFi adapter.
- Game ROM files

Optional additions:

- [Wireless keyboard](http://adafru.it/1737) (<http://adafru.it/1737>)
- [USB Battery Pack](http://adafru.it/1566) (<http://adafru.it/1566>) for portable use

Hey! Don't be fooled by the fun-and-games nature of this project. It's a challenging build that draws on a broad range of maker skills: fiddling with Linux commands, soldering, and even a bit of arts & crafts. Read through the whole guide before starting, decide if you're ready to tackle this and make sure you have everything you need.

Our original [Retro Gaming with Raspberry Pi \(https://adafru.it/dcs\)](https://adafru.it/dcs) guide is a little easier — same goal, fewer pieces, using a regular computer monitor for the display. You might want to start there if this project looks a bit daunting.

If you have a current “Gen 3” kit, you can skip ahead to the next page.

Prior “Gen 1” and “Gen 2” Kit Contents:

- [Adafruit PiTFT Mini Kit \(http://adafru.it/1601\)](http://adafru.it/1601)
- [Analog joystick with breakout board \(http://adafru.it/512\)](http://adafru.it/512)
- [16mm Buttons \(http://adafru.it/1445\)](http://adafru.it/1445) (4)
- [Arcade Button Quick Connect Wires \(http://adafru.it/1152\)](http://adafru.it/1152) (4)
- [Female/female jumper wires \(http://adafru.it/266\)](http://adafru.it/266) (strip of 4)
- [Cupcade Adapter PCB \(https://adafru.it/elN\)](https://adafru.it/elN)
- [26-pin GPIO ribbon cable \(https://adafru.it/f74\)](https://adafru.it/f74)
- [8 Ohm 1 Watt speaker \(http://adafru.it/1313\)](http://adafru.it/1313)
- [Right-angle 3.5mm audio plug to pigtail cable \(http://adafru.it/1700\)](http://adafru.it/1700)
- Acrylic case parts (15)
- 4-40 and 2-56 screws and nuts (15 and 3 ea., respectively)
- Nylon board standoffs (2)
- Piece of heat-shrink tubing
- Blank 4GB SD card
- [USB charger/power supply \(https://adafru.it/dfY\)](https://adafru.it/dfY)
- [USB A to micro B cable \(http://adafru.it/1513\)](http://adafru.it/1513)

Gen 1 kits had some additional parts not listed here; Gen 2 kits have these pre-assembled on the interface board.

You will also need:

- [Raspberry Pi Model B computer \(http://adafru.it/998\)](http://adafru.it/998) — later model with mounting holes. The early “V1” boards with no mounting holes will not work with this project. [Model A \(http://adafru.it/1344\)](http://adafru.it/1344) also works, but with only half the RAM this may impact performance.

- Soldering iron, solder, stranded or solid core wire (24 or 22 gauge) and related paraphernalia
- Masking tape
- Tiny screwdrivers
- For setup, you may temporarily need a keyboard and monitor
- Game ROM files

Optional additions:

- [USB Miniature WiFi Module \(http://adafru.it/814\)](http://adafru.it/814)
- [Wireless keyboard \(http://adafru.it/1737\)](http://adafru.it/1737)
- [USB Battery Pack \(http://adafru.it/1566\)](http://adafru.it/1566) for portable use

Plan Ahead



This is a red pill / blue pill moment.

Think a bit about the “old school” games you like to play. Home console games — those that connect to your TV — have a horizontal screen orientation. But in arcades, many games took advantage of a vertical screen.

Cupcade can use either a horizontal or vertical screen orientation, but this must be decided early on. It can be changed later, but this is a non-trivial operation; you’ll need to dismantle and reassemble the whole thing.



Horizontal Screen

- Pole Position
- Zero Wing
- Most Fighting Games

Vertical Screen

- Pac Man
- Dig Dug
- Zaxxon

There are also three different ways the controls can be arranged...but again, this is a commitment and a fair bit of work to change later.

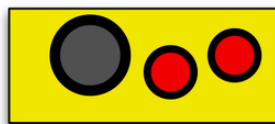

Joystick Left

Best for 2-button games.

- Scramble
- Qix
- Xevious

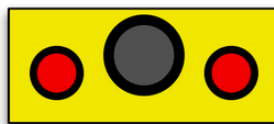

Joystick Center

Best for single-button or buttonless games.

- Pac Man
- Galaga
- Joust

Equally usable by right- or left-handed players.

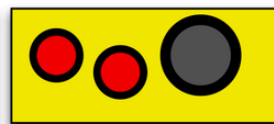

Joystick Right

Alternate 2-button layout for lefties.

Therefore: think ahead about which game(s) you're most likely to play. Maybe test them out on the Raspberry Pi before assembling the whole kit around it. Determine which perform acceptably with the emulator and look good on the screen...then choose a display and control combination that works well for the most (or most desirable) games from your list. Others can still be played, they're just less than optimal.

This basic joystick-and-two-buttons combo covers a vast number of classic arcade games. You can optionally plug in a USB keyboard for anything more complex.

Prep Work

The Cupcade cabinet is comprised of 16 laser-cut acrylic parts (15 in Gen 1 & 2 kits). Count the pieces to make sure everything's there.

Depending on your game control layout and choice of Raspberry Pi board, two or three of these pieces won't be used. This is normal.

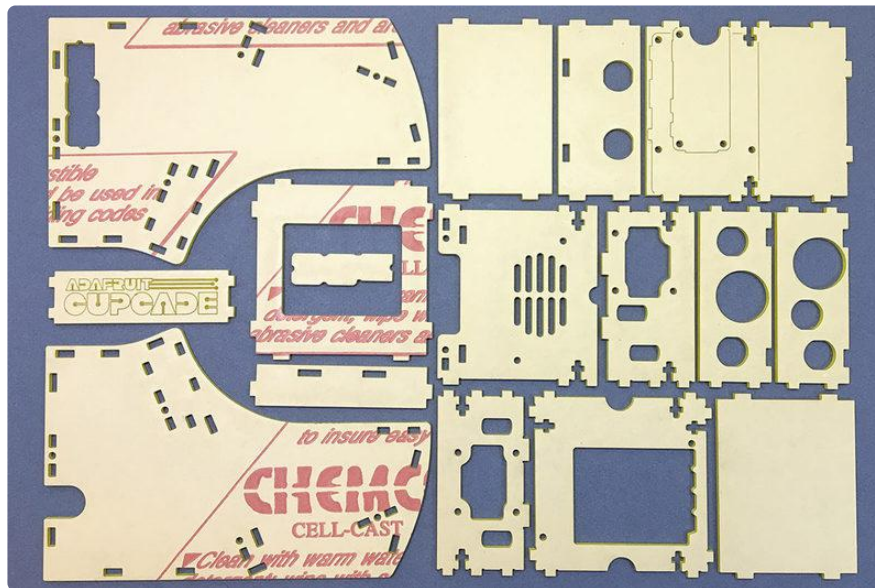

Peel the backing paper off both sides of all the laser-cut parts. It's easiest to start at a corner, catching the edge of the paper with a fingernail.

The laser-cutting process leaves a little paper soot at the edges. Wash off these parts with soap and water if you like, just be absolutely certain that all the parts are completely dry before assembling! That's why we're doing this first, to allow extra drying time.

Use only soap and water when cleaning these parts. Some chemicals, including rubbing alcohol and alcohol wipes, will damage the plastic!



The cabinet marquee has a Cupcade logo etched into it. Optionally, if you like this, you can make the design “pop” by scribbling over it with a marker and then buffing the surface with a tissue or paper towel. Do not do this with a permanent marker, unless you also have a dry-erase marker to follow up with (dry-erase markers remove “permanent” ink).



If you don't like the logo or want to add your own, just flip this piece over when assembling the case later.

(This is a Gen 3 detail. The marquee in Gen 1 & 2 kits is blank on both sides.)

Raspberry Pi Setup

Before assembling anything, let's get some software installed and tested on the Raspberry Pi board. Doing this early (rather than when everything's buried inside a case) makes troubleshooting easier.

SD Card Setup

Start by downloading an SD card image for RetroPie, a nice game emulation package. You'll find this on the [RetroPie download page \(https://adafru.it/rA3\)](https://adafru.it/rA3). Note there are two versions:

- One version for single-core Raspberry Pi boards like the Pi Zero or Pi 1 B+.
- Another for multi-core boards like the Pi 2 and 3.

Download the correct one for your chosen Cupcade hardware...they are not cross-compatible.

After downloading you'll need to "burn" this software to a microSD card. We really like [Etcher \(https://adafru.it/sOe\)](https://adafru.it/sOe) for this purpose.

While that's downloading and burning, let's get some things together...

- During setup, the Raspberry Pi will be connected to an HDMI monitor. You'll need a cable for that. Pi Zero boards require a mini HDMI cable. Once everything's working, the monitor and cable are no longer needed.
- You will also need a USB keyboard during setup. Again the Pi Zero presents a special situation...you'll probably need an "on the go" adapter cable for this.
- The Pi will need to be connected to the internet. This is easiest on the Pi 2 and 3 if you have an Ethernet drop. Otherwise, WiFi is an option, though there are some gotchas. A Pi 2 or Pi 1 B+ needs a USB WiFi adapter. Pi 3 and Pi Zero W have built-in WiFi, but only for 2.4 GHz networks. Another Pi Zero option is called an "Ethernet gadget" over USB, explained in [this guide \(https://adafru.it/tbT\)](https://adafru.it/tbT).

While you can type all the installation commands that will follow. It's vastly easier if you have ssh enabled on the Pi and a terminal program that handles ssh remote logins. Then you can copy-and-paste commands from this guide to the terminal window.

Depending on your Etcher preferences, it may automatically unmount the SD card filesystem after writing, in which case remove the card and re-insert it in the card reader.

You should see a small WIN32 filesystem called "boot". Create a new file called "ssh" in the root level of this disk — this can be created with a text editor, or just copy any small file there and rename it "ssh". Then unmount the card and insert it in the Pi.

First Boot

The extra parts (PiTFT, joystick, etc.) should NOT be connected yet. Just the Pi, USB keyboard and HDMI monitor (and a network adapter, if your Pi needs it).

When power is first connected, the Pi will go through a quick boot and re-boot as it expands the filesystem to make use of the full SD card. Then you'll see the RetroPie splash screen and after about a minute this welcome screen:

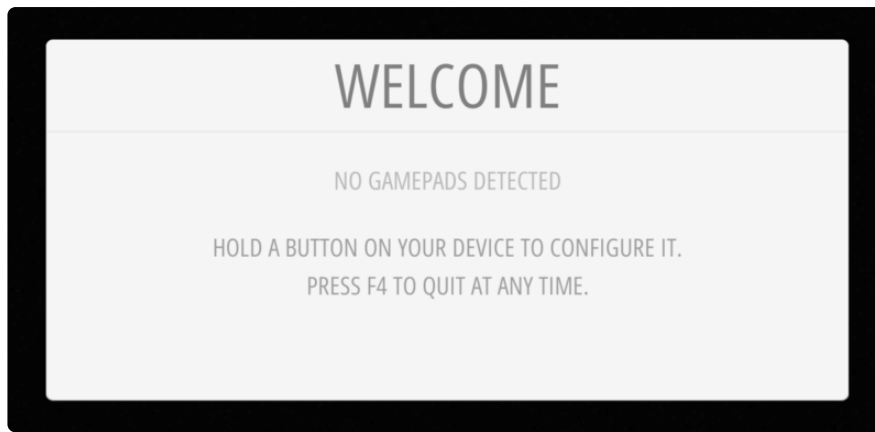

We need to set up the system to accept keyboard input for navigating the RetroPie menus. Later we'll make this work with the Cupcade controls, but for now we need keyboard control...

Hold down any key for a few seconds so the system acknowledges the keyboard for input, then you'll get to a configuration screen starting with the D-pad directions. Tap a key corresponding to the control that's highlighted.

Here's the recommended key mapping for Cupcade:

RetroPie Control/Button	Key
D-pad Up	Up arrow
D-pad Down	Down arrow
D-pad Left	Left arrow
D-pad Right	Right arrow
Start	1
Select	5

"A" Button	Left "Control" key
"B" Button	Left "Alt" key

Keep track of what you set up here, because you'll need to use these keys later for navigating menus.

You'll be prompted for about a dozen more controls ("X" and "Y" buttons and so forth), but none of these are necessary for navigating RetroPie menus nor does the Cupcade cabinet we'll build later have enough buttons for all these. So...for everything after the "B" button, just hold down any key on the keyboard for a couple seconds, until the Configuration screen says "Not Defined" and skips ahead to the next item. Repeat this through the whole end of the list. At the end you'll be asked about an undefined hotkey enable button. Just select the default "Yes" here — meaning you'll press the Start+Select buttons together to exit a game and return to the RetroPie menus. (You click "Yes" by pressing the "A" button you set up during this process — e.g. left Control key in the example key mapping above.)

Enable WiFi (if needed)

Now that the controls are enabled, you can access RetroPie menus to set up WiFi (if using wired Ethernet, you can skip ahead to "Download and Install..." below).

With no games installed on the card yet (more on that later), the only RetroPie menu option should be "Configuration." (If not, move left or right until that item's active), then press your "A" button (e.g. left Control key) to select it.



Highlight the “WiFi” option at the bottom of this list and press the A button again. This runs a WiFi configuration utility, which is all text-based...so this works with the keyboard’s arrow keys, tab and enter keys to select menu items, and when asked for the network password just use the keyboard as normal.

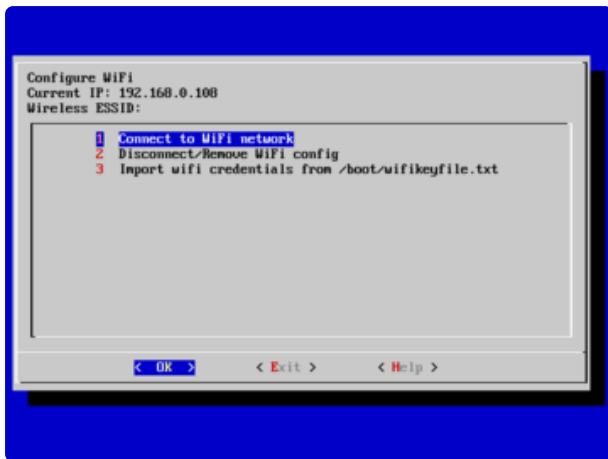

When finished, WiFi networking should be enabled. If not, you might need a reboot. Press the B button (e.g. left Alt key) to exit the Configuration menu, then from the main RetroPie screen press the Start button (e.g. 1 key), navigate down to “Quit” and restart the system.

Gen 1 & 2 Cupcade users: there’s also an option in the RetroPie menu to run the raspi-config program, which includes an option for overclocking...very helpful on these early Pi systems. Most can handle the “Medium” overclock setting with no ill effects. Gen 3 Cupcades don’t require this...newer Pi boards already use dynamic overclocking automatically.

Download and Install Cupcade Software

With networking enabled on the Pi (either WiFi or Ethernet), now we can install the extra software bits to support the Cupcade hardware. There’s two ways to do this...

```
SSH is enabled and the default password for the 'pi' user has not been changed.
This is a security risk - please login as the 'pi' user and type 'passwd' to set a new password.

***      Thursday, 15 March 2018, 10:30:00 pm UTC
****      Linux 4.9.35-07+ armv7l GNU/Linux
*****

***      Filesystem      Size  Used Avail Use% Mounted on
****      /dev/root          300  1.9G  27%  7% /
*****

***      Uptime.....: 0 days, 00:00:00
****      Memory.....: 2520288 (Free) / 7563232 (Total)
*****

***      Running Processes: 132
****      IP Address.....: 192.168.0.100
*****

***      Temperature.....: CPU: 67°C/147°F GPU: 67°C/133°F
****      The RetroPie Project, https://retropie.org.uk
*****

pi@retropie:~$
```

One option is to type commands directly on the Pi. From the RetroPie main screen, press “F4” to exit the GUI and get a command line prompt. From here, you could test the network connection by typing:

```
ping 8.8.8.8
```

(Press Control+C to exit)

Or, if you didn’t already set up ssh as explained in the “SD Card Setup” section of this page, you could type:

```
sudo raspi-config
```

In the “Interfacing Options” menu you’ll find an option to enable ssh, then use the second option...

Second option, generally better, is to log in remotely using an ssh-capable terminal program and copy-and-paste later commands directly from this web page into the terminal window. Some of the commands are cryptic and very specific about spelling, so this is best.

The Pi system should appear on your network as `retropie.local`, e.g. from Linux or a Mac Terminal window you’d type:

```
ssh pi@retropie.local
```

and enter the password for the pi user (“raspberrypi” by default).

If using a Windows system and it doesn’t recognize the “retropie.local” system on the network, you may need to install the Zeroconf software [as explained in this guide \(https://adafru.it/IPE\)](https://adafru.it/IPE).

To install software for the PiTFT display, enter the following lines exactly:

```
cd ~
sudo apt-get install -y git python3-pip
sudo pip3 install --upgrade adafruit-python-shell click
git clone https://github.com/adafruit/Raspberry-Pi-Installer-Scripts.git
cd Raspberry-Pi-Installer-Scripts
```



```

pi@raspberrypi:~ $ cd ~
pi@raspberrypi:~ $ sudo pip3 install --upgrade adafruit-python-shell click==7.0
Looking in indexes: https://pypi.org/simple, https://www.piwheels.org/simple
Collecting adafruit-python-shell
  Using cached https://www.piwheels.org/simple/adafruit-python-shell/adafruit_py
thon_shell-1.2.1-py3-none-any.whl
Collecting click==7.0
  Using cached https://files.pythonhosted.org/packages/fa/37/45185cb5abbc30d7257
104c434fe0b07e5a195a6847506c074527aa599ec/Click-7.0-py2.py3-none-any.whl
Requirement already satisfied, skipping upgrade: clint in /usr/local/lib/python3
.7/dist-packages (from adafruit-python-shell) (0.5.1)
Requirement already satisfied, skipping upgrade: Adafruit-PlatformDetect in /usr
/local/lib/python3.7/dist-packages (from adafruit-python-shell) (2.17.0)
Requirement already satisfied, skipping upgrade: args in /usr/local/lib/python3.
7/dist-packages (from clint->adafruit-python-shell) (0.1.0)
Installing collected packages: adafruit-python-shell, click
Successfully installed adafruit-python-shell-1.2.1 click-7.0
pi@raspberrypi:~ $ sudo apt-get install -y git
Reading package lists... Done
Building dependency tree
Reading state information... Done
Suggested packages:
  git-daemon-run | git-daemon-sysvinit git-doc git-el git-email git-gui gitk
  gitweb git-cvs git-mediawiki git-svn

```

If your cupcade display will be in horizontal (wider than taller) mode, enter:

```
sudo python3 adafruit-pitft.py --display=28r --rotation=90 --install-type=fbcpc
```

If your cupcade display will be in vertical (wider than taller) mode, enter:

```
sudo python3 adafruit-pitft.py --display=28r --rotation=180 --install-type=fbcpc
```

It will take several minutes to update your Pi software and install packages

```

pi@raspberrypi:~ $ cd ~
pi@raspberrypi:~ $ sudo pip3 install --upgrade adafruit-python-shell click==7.0
Looking in indexes: https://pypi.org/simple, https://www.piwheels.org/simple
Collecting adafruit-python-shell
  Using cached https://www.piwheels.org/simple/adafruit-python-shell/adafruit_py
thon_shell-1.2.0-py3-none-
any.whl
Collecting click==7.0
  Using cached https://files.pythonhosted.org/packages/fa/37/45185cb5abbc30d7257104c434fe0b07e5a195a684750
6c074527aa599ec/Click-7.0-py2.py3-none-any.whl
Requirement already satisfied, skipping upgrade: clint in /usr/local/lib/python3.7/dist-packages (from ada
fruit-python-shell) (0.5.1)
Requirement already satisfied, skipping upgrade: Adafruit-PlatformDetect in /usr/local/lib/python3.7/dist-
packages (from adafruit-python-shell) (2.17.0)
Requirement already satisfied, skipping upgrade: args in /usr/local/lib/python3.7/dist-packages (from clin
t->adafruit-python-shell) (0.1.0)
Installing collected packages: adafruit-python-shell, click
Successfully installed adafruit-python-shell-1.2.0 click-7.0
pi@raspberrypi:~ $ sudo apt-get install -y git
Reading package lists... Done
Building dependency tree
Reading state information... Done
git is already the newest version (1:2.20.1-2+deb10u3).
0 upgraded, 0 newly installed, 0 to remove and 0 not upgraded.
pi@raspberrypi:~ $ git clone https://github.com/adafruit/Raspberry-Pi-Installer-Scripts.git
Cloning into 'Raspberry-Pi-Installer-Scripts'...
remote: Enumerating objects: 30, done.
remote: Counting objects: 100% (30/30), done.
remote: Compressing objects: 100% (23/23), done.
remote: Total 544 (delta 13), reused 18 (delta 7), pack-reused 514
Receiving objects: 100% (544/544), 181.33 KiB | 1.63 MiB/s, done.
Resolving deltas: 100% (205/205), done.

```

```
removing old section...
##### UPGRADING KERNEL #####
Updating packages...
Upgrading packages...
Installing Kernel Headers...
PITFT make: Entering directory '/usr/src/linux-headers-5.4.51-
PITFT Building modules, stage 2.
PITFT MODPOST 2 modules
PITFT LD [M] /home/pi/Raspberry-Pi-Installer-Scripts/st7789_
PITFT LD [M] /home/pi/Raspberry-Pi-Installer-Scripts/st7789_
PITFT make: Leaving directory '/usr/src/linux-headers-5.4.51-
PITFT Success!

Settings take effect on next boot.

REBOOT NOW? [Y/n]
```

After the script runs it will ask if you want to reboot. Since we have more things to install, select “no.”

Additional Steps for GEN 3 KITS ONLY

Skip these steps if building an earlier kit...different directions are provided below.

To install software for I2S audio used by Cupcade Gen 3, enter this line exactly:

```
curl -sS https://raw.githubusercontent.com/adafruit/Raspberry-Pi-Installer-Scripts/master/i2samp.sh | bash
```

```
Adding Device Tree Entry to /boot/config.txt
dtoverlay=hiberry-dac
dtoverlay=i2s-mmap

Disabling default sound driver
Configuring sound output

Installing aplay systemd unit

You can optionally activate '/dev/zero' playback in
the background at boot. This will remove all
popping/clicking but does use some processor time.

Activate '/dev/zero' playback in background? [RECOMMENDED] [y/N]
All done!

Enjoy your new i2s amplifier!

Some changes made to your system require
your computer to reboot to take effect.

Would you like to reboot now? [y/N] N
```

When asked if you want /dev/zero playback, say N(retropie does this already)

This script does its job quickly. At the end it will ask whether to test the speaker, answer “no” since we haven’t assembled any hardware yet.

Finally, to enable the Arcade Bonnet’s joystick and button features, enter:

```
curl https://raw.githubusercontent.com/adafruit/Raspberry-Pi-Installer-Scripts/master/arcade-bonnet.sh &gt;arcade-bonnet.sh
sudo bash arcade-bonnet.sh
```

```
EXISTING INSTALLATION, IF ANY, WILL BE OVERWRITTEN.
CONTINUE? [y/N] y
Disable overscan? [y/N] y
Install GPIO-halt utility? [y/N] n

Overscan: disable.
Install GPIO-halt: NO

CONTINUE? [y/N] y

Starting installation...
Updating package index files...
Hit:1 http://archive.raspberrypi.org/debian stretch InRelease
Hit:2 http://raspbian.raspberrypi.org/raspbian stretch InRelease
Reading package lists... 72%
```

You'll be asked if you want to disable overscan. Yes! Disable overscan!

Install GPIO-halt utility? No.

This script takes a little longer to run. When it's finished, you'll be asked whether to reboot. Answer "no" again

Additional Steps for GEN 1 & 2 KITS ONLY

Skip these steps if building a Gen 3 kit...use the directions above.

Audio in these Cupcades requires no extra software, but does need a little volume adjustment. Type:

```
alsamixer
```

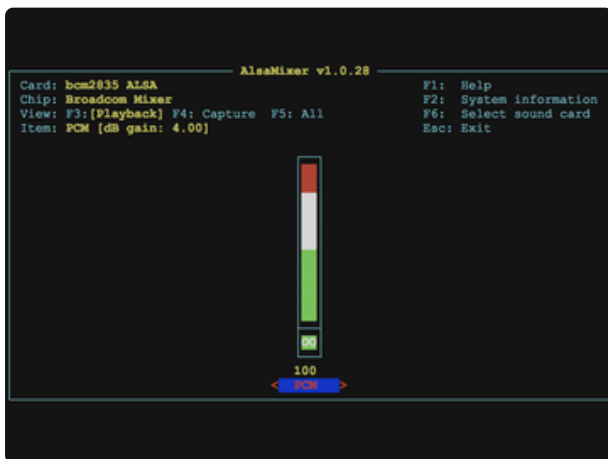

Press the up arrow until the volume level is at the maximum. Then press the Escape key to save and exit.

Joystick and button features rely on our retrogame software, installed with:

```
curl https://raw.githubusercontent.com/adafruit/Raspberry-Pi-Installer-Scripts/master/retrogame.sh &gt;retrogame.sh
sudo bash retrogame.sh
```

This script supports several Adafruit gaming projects, and you'll see Cupcade among the listed options — select that one.

After the script runs it will ask if you want to reboot. Select “no.”

Last Steps for ALL Cupcade Versions

Now shut the system down manually:

```
sudo shutdown -h now
```

Give it about 20 seconds before disconnecting power (watch the status LED on the Pi board — when it makes a steady blink a few times and then turns off, it’s safe to disconnect).

The software’s all ready to test now, but we need to solder up a few bits first...

Gen 3 Kit

The directions on the next few pages relate only to the current third-generation (“Gen 3”) Cupcade kit. If you have a first- or second-generation kit (Gen 1 or 2), skip ahead to the corresponding section.

If you bought your kit from Adafruit recently, it’s the current Generation 3 kit. There might still be some earlier kits elsewhere out there in the pipeline. The differences are most easily spotted in the electronics...

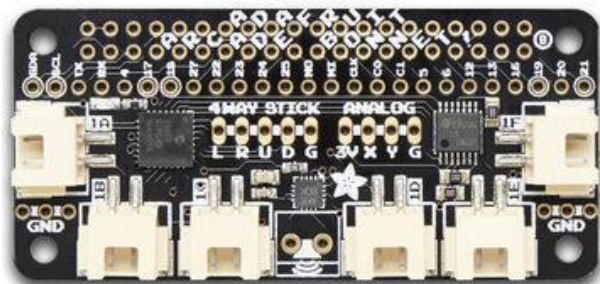

Generation 3 (current) Cupcade kits include the Adafruit Arcade Bonnet with the 40-pin GPIO header as used on current Raspberry Pi boards.

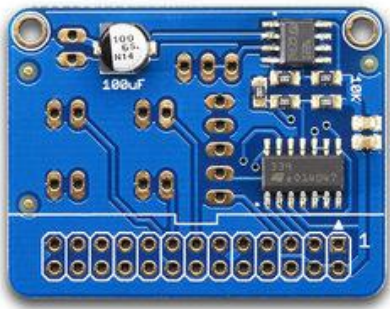

Generation 2 kits used the Cupcade Adapter Board with the 28-pin GPIO header as used on the Pi 1 Model B.

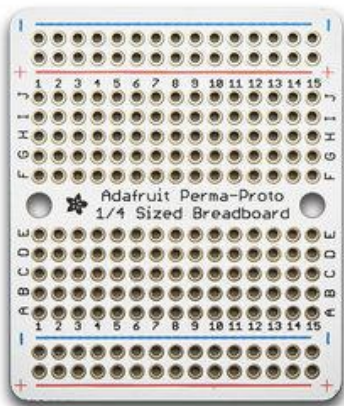

Generation 1 kits had you solder up several components and wires on an Adafruit Perma Proto board.

Don't feel left out if you're running a prior kit! Still entirely playable and in fact we're using the exact same software across all of them. The changes are mostly to accommodate new hardware as supplies of the original Pi 1 Model B dried up.

Assemble Components

These directions are for the current "Gen 3" Cupcade kit.

Buttons



No soldering for this first step...

Plug a quick-connect wire set into each of the four buttons.

There's no specific polarity to these... either wire can go to either pin.

PiTFT Display

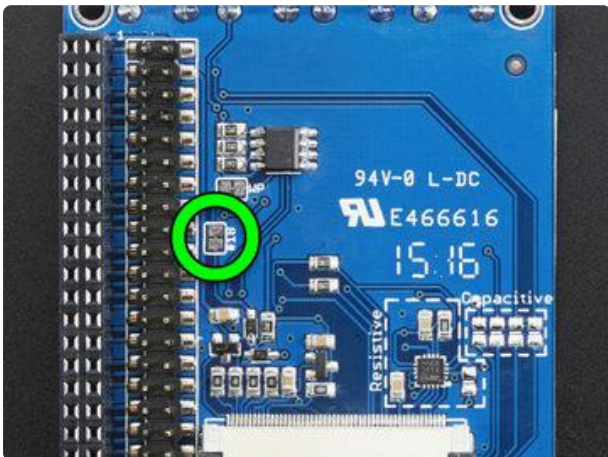

On the back of the PiTFT, near the GPIO pins, are two pads labeled “#18” with a narrow PCB trace between them.

Using a hobby knife or pointed file, scrape between the two pads to cut this trace. (It's OK — if you ever need this back, a blob of solder between the pads will make the connection again.)

This makes sure the backlight stays on at full brightness. RetroPie otherwise has a tendency to make things dim and muddy.

The remaining parts all require some amount of soldering...

Joystick

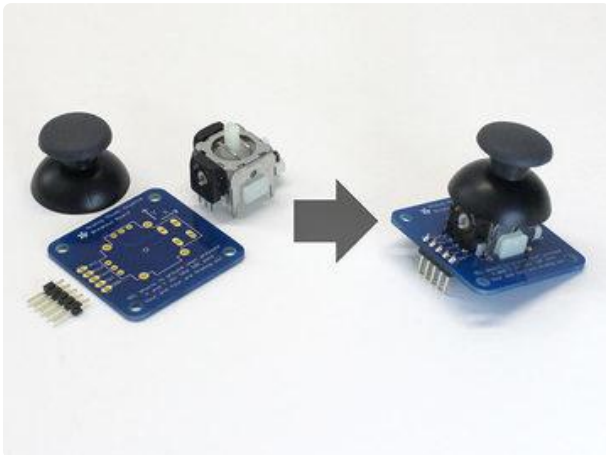

The analog thumb joystick board has a 5-pin header and quite a few pins on the stick component itself. Some of the pins may be a little bent from shipping and need to be nudged into place. The “hat” simply presses into place.

Install a 5-pin header from below, so the pins are pointing “back” as shown here.

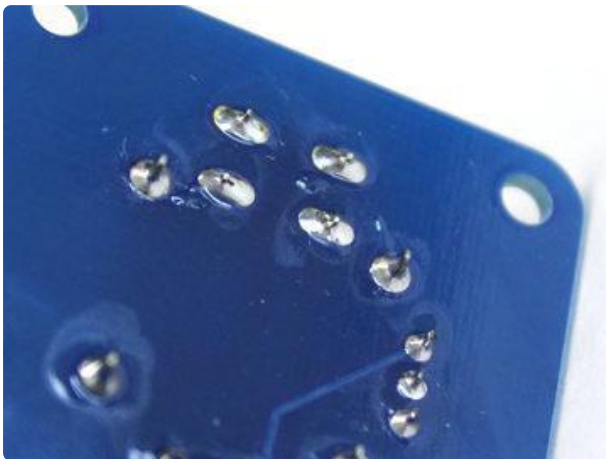

Make sure all your solder connections are smooth and clean, like tiny Hershey’s Kisses®. There should be no solder balls or bridges, no gaps between pins and their corresponding pads.

Speaker

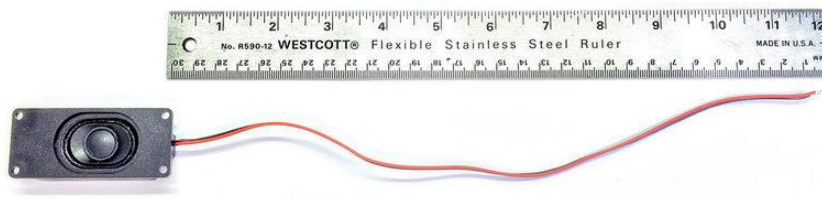

The plug on the end of the speaker cable isn’t needed. Cut the wires to about 12 inches (30 cm), strip a few millimeters of insulation off the ends, and tin each wire with solder so they don’t fray.

Arcade Bonnet

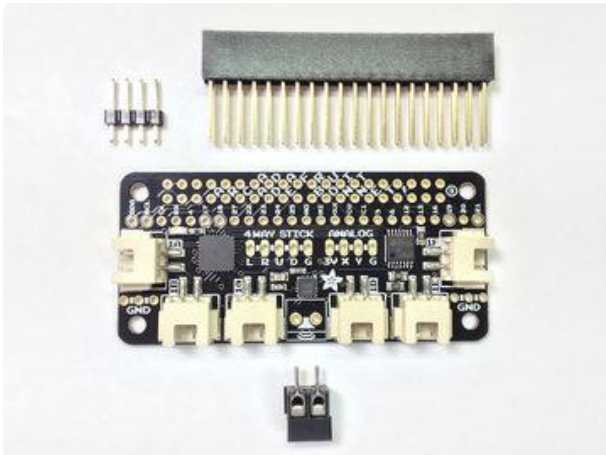

Three components are soldered to the Arcade Bonnet board:

- A 2-pin screw terminal goes at the bottom center, where there's a small speaker icon. This goes on the top side of the board like the other components, and is soldered underneath.
- A 4-pin header goes to the ANALOG pins, also inserted from the top and soldered underneath.
- A 40-pin GPIO stacking header is installed the opposite way — inserted from the bottom and soldered on the top (component) side.

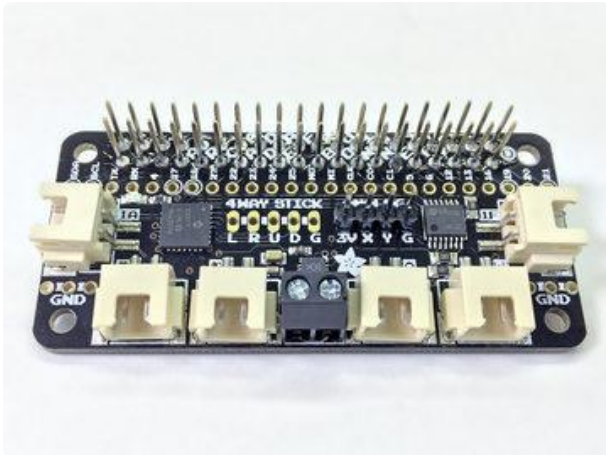

As always, be mindful of solder bridges, cold joints, etc.



Not shown here: If using a Raspberry Pi Zero board, it must have a 40-pin male GPIO header installed. The Pi Zero WH already includes this header. For other Pi Zero variants, such a header must be soldered in place, or there are solderless variants as well.

After inspecting your work, switch off your iron, all the soldering's done now!

Dry Run

These directions are for the current “Gen 3” Cupcade kit.

Given this project’s complexity, we’ll be testing and re-testing the system to validate our progress. Confirm your system passes each test before advancing to the next. Mis-steps are very time-consuming!

PiTFT Test



Install just the PiTFT display atop the Raspberry Pi, none of the other parts yet.

You no longer need an HDMI monitor at this point. Most can’t display the resolution we’ve configured the Pi for anyway.

Plug in a USB keyboard and connect power. The PiTFT screen should light up white. After about 10 seconds, it should switch to black, and within a minute you should see the RetroPie splash screen and then the main menu (it might be horizontal or vertical depending how you previously configured the PiTFT software).

That’s it for this test! If it works, use the keyboard to navigate to RetroPie’s Quit→Shutdown System option. Wait about 20 seconds for the system to complete this operation before disconnecting power.

ALWAYS turn off Cupcade using the Shutdown System menu option. Just pulling the plug runs the risk of corrupting the SD card contents, and you’d have to start over.

If the PiTFT doesn't work...

- Make sure it's properly aligned atop the 40-pin GPIO header, not offset to one side or the other.
- Check for electrical shorts between the GPIO pins and the metal edge of the LCD screen.
- Go back to the “Raspberry Pi Setup” page and confirm you've run the PiTFT install script correctly.

Do not continue until the PiTFT is working in this configuration. If it's still giving you trouble, ask for help in the [Adafruit Forums \(https://adafru.it/jlf\)](https://adafru.it/jlf). Clear photos always help!

Arcade Bonnet and Remaining Parts

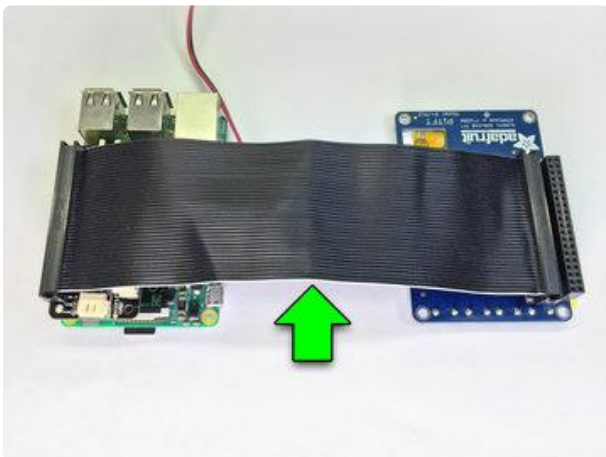

Disconnect the PiTFT from the Raspberry Pi, then plug the Arcade Bonnet in its place.

Install the 40-pin GPIO ribbon cable between the Arcade Bonnet stacking header and the pins on the PiTFT display.

Note the polarity of the ribbon cable at both ends — the white wire along one edge gives an indication. On the Pi, this should run parallel to the SD card edge of the board. On the PiTFT, this is nearest the edge with the buttons.

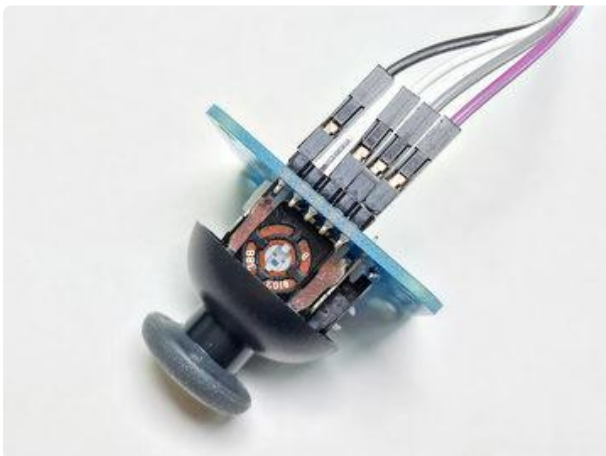

There are 5 pins on the joystick board, but only 4 jumper wires in the kit. Skip over the “Sel” pin...only the VCC, Xout, Yout and GND pins are used in Cupcade.

The colors of the wires in your kit may be different than what's shown here. That's OK, just take note of what color connects to which pin.

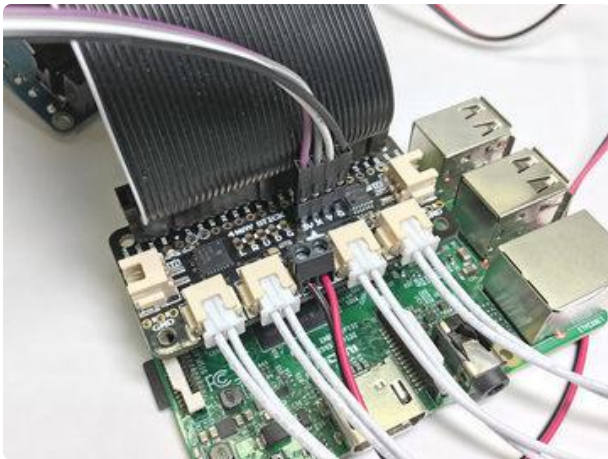

Carefully fold back the ribbon cable atop the Arcade Bonnet.

Connect the 4 wires from the joystick to the ANALOG header:

- VCC → 3V
- Xout → X
- Yout → Y
- GND → G

Plug the two wires from the speaker into the screw terminals and tighten with a tiny screwdriver. Polarity doesn't matter here — either wire can go to either terminal.

Plug the 4 buttons into the 4 connectors along the same edge of the Bonnet. The order doesn't matter right now, it can be anything for testing.

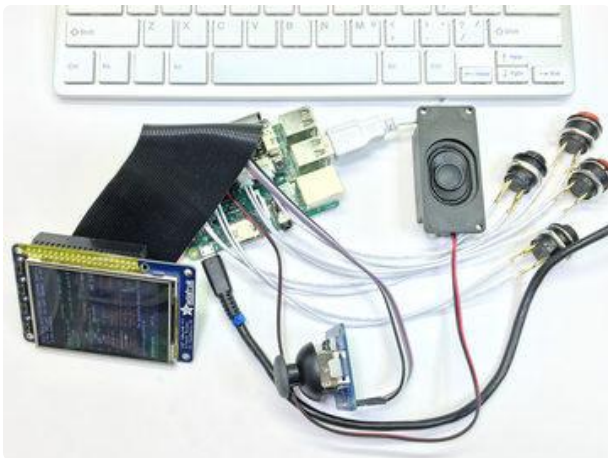

Spread out the parts on your work surface, making sure no metal bits contact each other. Connect a USB keyboard and then connect power to the Pi.

If all goes well, the screen should repeat the same process as the first test: lights solid white at first, switches to black after about 10 seconds, and then the RetroPie splash screen follows a bit later.

If the PiTFT Doesn't Work Now

(But did work on the first test)

- Check the soldering of the 40-pin GPIO stacking header on the Arcade Bonnet. Make sure there are no solder bridges or cold joints. If you spot any trouble, unplug the Bonnet from the Pi before re-soldering these points.

- If you have some patience and a multimeter with a continuity beep function, unplug the ribbon cable and check each connection by inserting 2 male jumper wires into corresponding pins at each end, one at a time. It's a rare occurrence but I've seen a few ribbon cables that were improperly crimped.
- If the cable's good but screen still isn't working...if you're good with soldering, try "tinning" each of the long pins of the stacking header. This fattens them up a bit, so the ribbon cable gets a better grip.

If the PiTFT Does Work

Yay! Let's test the other parts...

Press F4 to exit RetroPie and get a command line prompt.

Try pressing the buttons and moving the joystick. Some of these should produce characters on the screen. (It's normal that not all of them will...by default some buttons may be assigned to "modifier" keys like Shift or Control which don't produce any output on their own.)

Press Return on the keyboard a couple of times (ignore any error message) and then type:

```
sudo aplay /usr/share/sounds/alsa/Front_Center.wav
```

You should hear a spoken "front center" from the speaker.

If that all works...congratulations! Shut down the Pi by typing:

```
sudo shutdown -h now
```

Wait about 20 seconds for this operation to complete before disconnecting power. Then you can then proceed to the next build steps.

If the Buttons/Joystick Don't Work

It's normal during testing that some of the buttons won't produce output. If any of them do work, that means the Arcade Bonnet is working and everything's fine there. Otherwise...

- Check the soldering on the GPIO stacking header as previously described.
- Check that the jumper wires are making contact and are connected between the right points on the joystick board and Arcade Bonnet (remember, the "Sel" pin is not connected).
- Confirm the Arcade Bonnet software is correctly installed as explained on the "Raspberry Pi Setup" page.

If Sound Doesn't Work

- Check the soldering on the GPIO stacking header.
- Check the screw terminals are actually making contact with the speaker wires and aren't just closing on insulation.
- Check for a short between the speaker wires (e.g. frayed wire ends).
- Confirm the audio software is correctly installed as explained on the "Raspberry Pi Setup" page.

Do not continue until all tests pass. You can ask for help in the [Adafruit Forums \(https://adafru.it/dYq\)](https://adafru.it/dYq).

Cabinet Part 1

These directions are for the current "Gen 3" Cupcade kit.

A handful of images from different Cupcade revisions might still be present in the following pages. Don't panic if your Cupcade looks slightly different...it should all work the same. Lighting and staging photos is time-consuming!

Fitting all the electronics inside the case is the most challenging part of this project. Our advice:

- Don't force anything. If something refuses to fit, it might simply be in the wrong position.

- You might need to temporarily disconnect some parts (like the buttons or joystick) to re-route the wires in a less tangled manner. Sometimes repeatedly. If the wiring seems to magically change from one of our photos to the next, that's exactly what happened.
- Take your time. If things aren't cooperating and you get frustrated, walk away, try again after a break.

Why not just design a case that's easier to assemble?

It makes sense once it's all together. There are just a few visible screws on the sides, and the area around the controls is perfectly smooth, with no screw heads scratching at your fingers. An easier case would have a lot more visible fasteners, some of them in uncomfortable positions!

With the Pi powered off, disconnect all of the separable parts:

- Raspberry Pi board
- PiTFT+ display
- Arcade Bonnet board
- Ribbon cable
- Speaker
- Joystick
- Buttons (4)

Buttons



Remove all of the nuts and washers from the four buttons. You can leave the quick-connect wires attached.

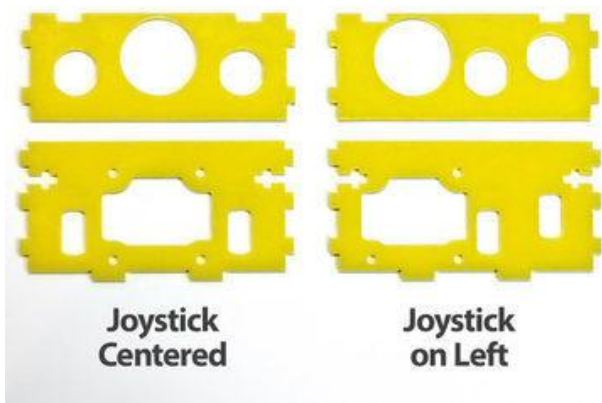

Early on, we mentioned a choice to be made: centered or off-center joystick? Now is your last chance to decide.

There are two acrylic parts required for the controls. Select the pair that matches your desired control layout. The other two can be stored somewhere in case you want to switch it out later.

If you want the joystick on the right, just flip these pieces over.

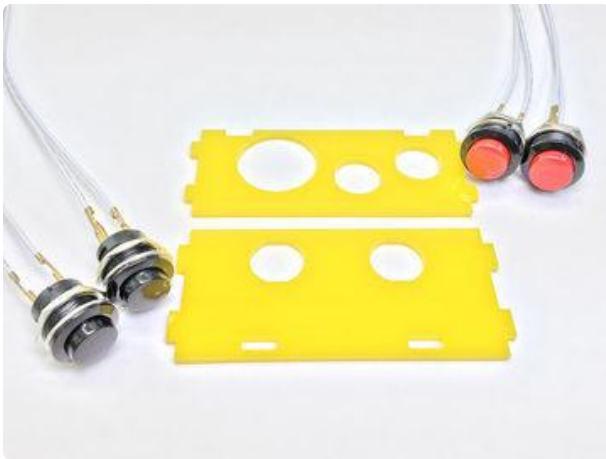

Insert the two red buttons into the chosen control cutout. The two black buttons then go in this cabinet front piece.

Notice the piece with the red buttons has two “bites” along the top edge. If they’re at the bottom, and using an off-center joystick, undo the buttons and flip this piece over.



Reinstall the washer and nut on each button from behind. Tighten these with finger pressure only. Don’t use tools or you’ll crack the plastic!



Joystick

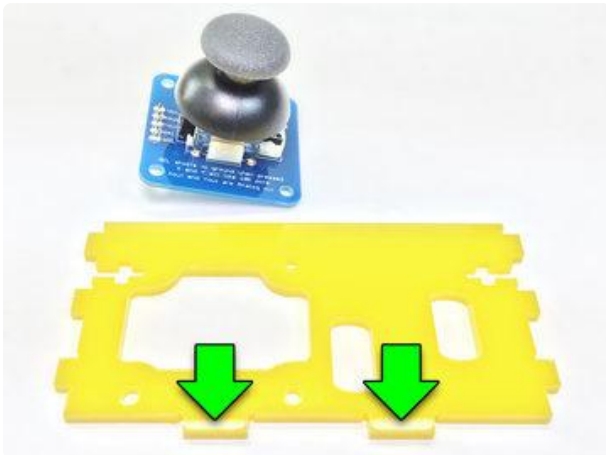

When installing the joystick on this support piece, make sure these two bumps are at the bottom.

Insert three screws as shown (not four), front to back, and then add a nut to each.

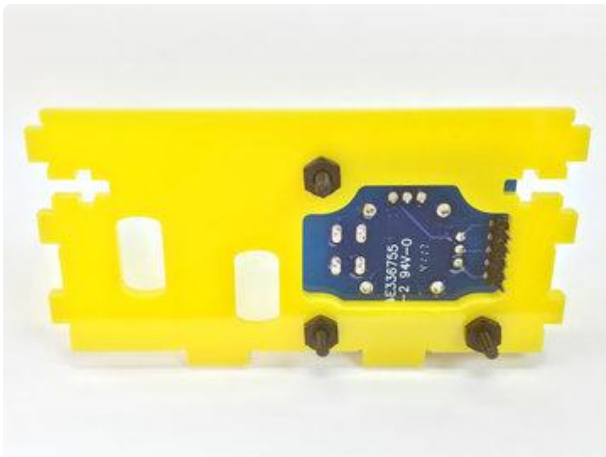
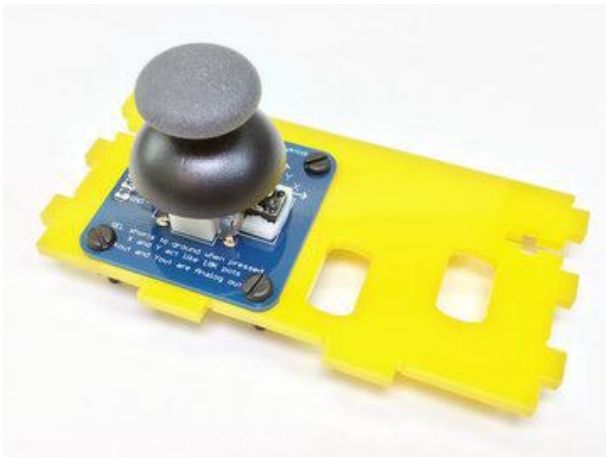

Speaker

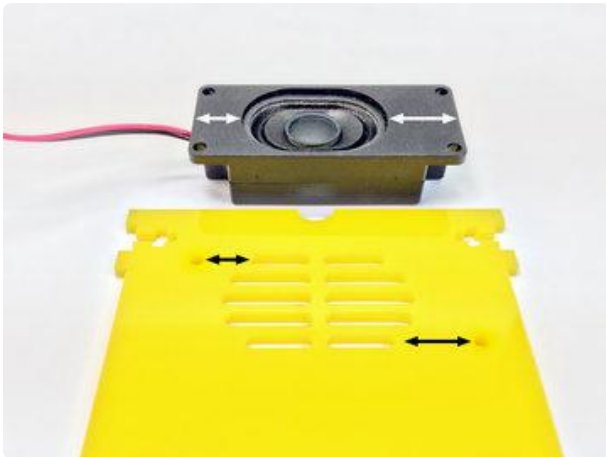

Look closely and you'll notice the speaker enclosure is asymmetrical. It needs to be turned the correct way for the speaker cone to be centered over the grille cutout.

The speaker mounts behind this piece of the case. Insert two screws from the front, passing through both the case piece and speaker mounting holes. Then add two nuts from the back.

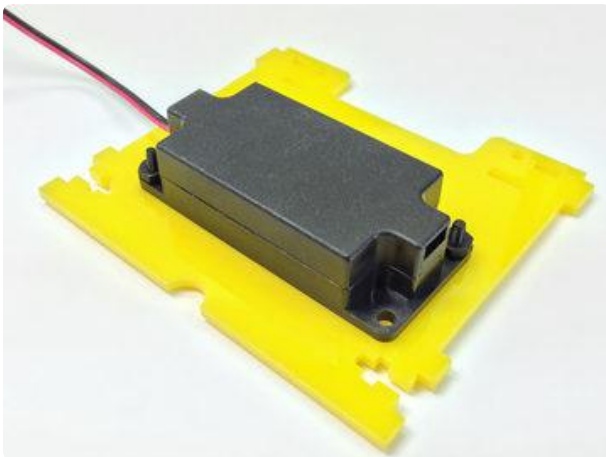
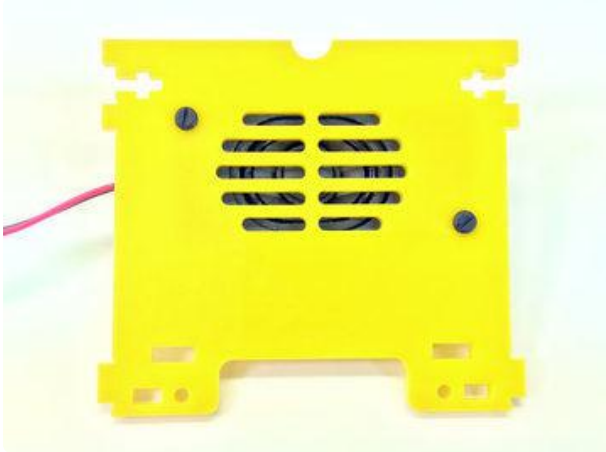

Screen

Shown in a vertical orientation here, these parts are assembled the same regardless whether you'll use a horizontal or vertical screen orientation. We'll just turn the whole assembly one way or the other in a later step.

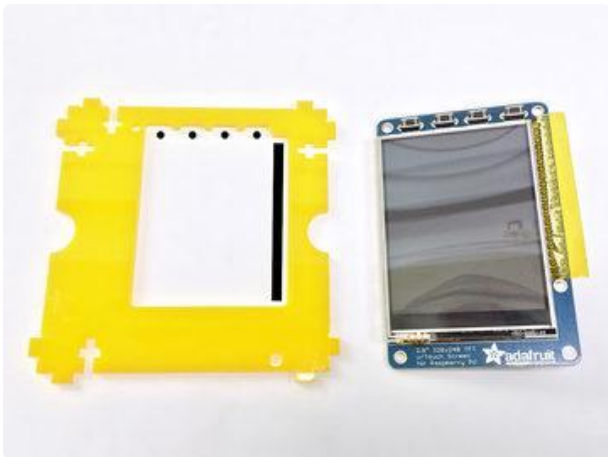

Turn this screen support piece around until you find the correct alignment for the buttons and GPIO header.

Place the display atop this piece with the header settling into the large center hole and these two mounting holes aligned. Insert two screws front to back. Add nuts at the back.

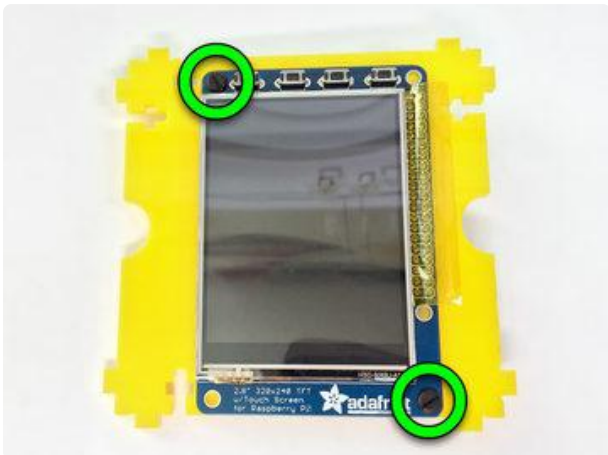

If you plan to install the screen in a vertical (portrait) orientation, clip just a tiny bit (about 1/8" or 3mm) off the tip of this one screw that's aligned with the GPIO header.



Base

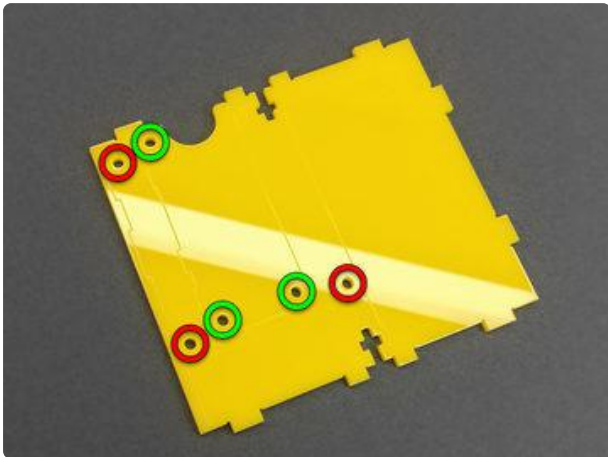

The base piece has board outlines scored on the top surface, and six mounting holes. The three “inner” holes (outlined in green) are for Raspberry Pi Zero boards, while the “outer” holes (outlined red) are for a Pi 3, Pi 2, etc. We’ll use just one set or the other, depending which board you’ve got.

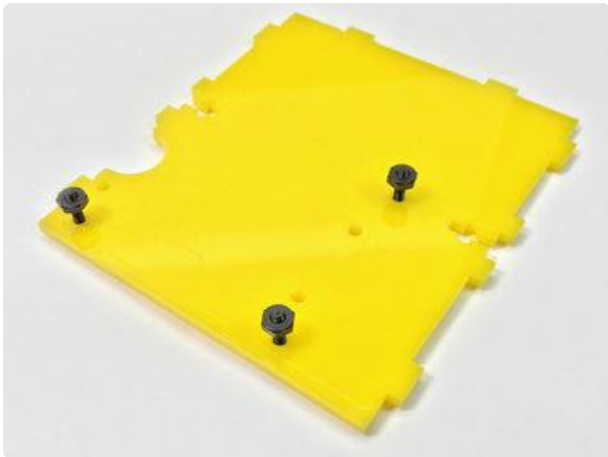

Insert a screw, coming up from the underside, through each of the three mounting holes...whichever set you’re using...then add a nut from the top side.

Don’t tighten these nuts all the way. They should be positioned only about halfway along the screws’ length.

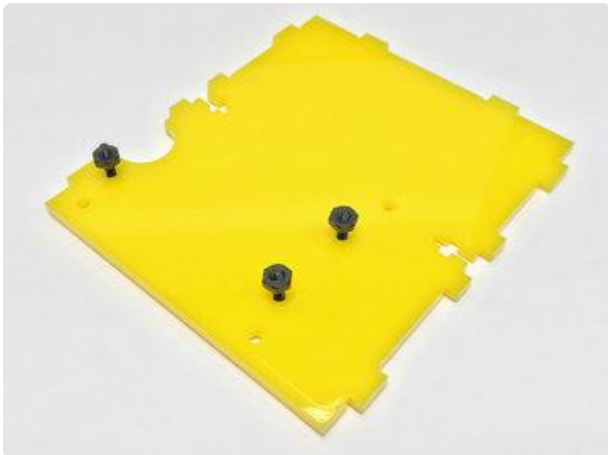

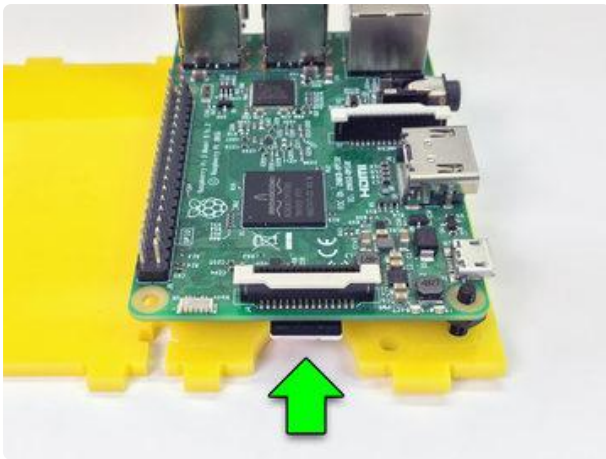

Now set the Raspberry Pi atop the screws. Only three of the board's four mounting holes are used (the fourth would interfere with other parts of the case).

Make sure the SD card slot is aligned with this semicircular "bite" in the base. I've built this project dozens of times now and still get this wrong sometimes, then have to go back and re-do these steps!

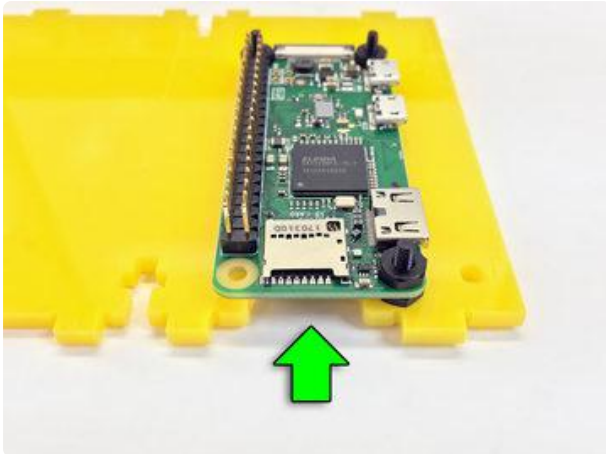

The Raspberry Pi's mounting holes sit fairly close to some components. Close enough that we can't just spin a nut down into place to secure the board, because the components interfere. There's a trick to making this work...

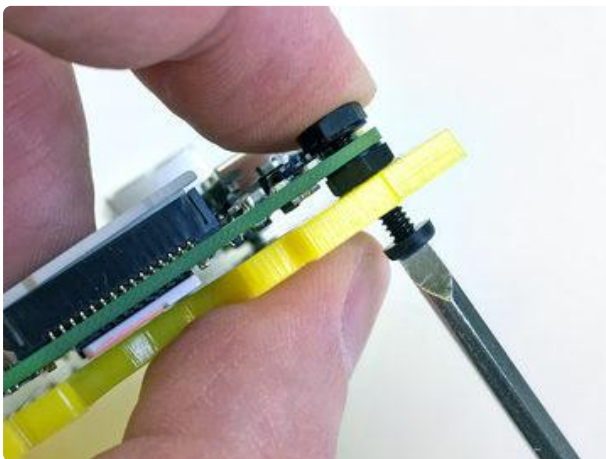

Instead, set a nut on the tip of one screw, and observe how it bumps up against nearby parts (such as the end of the GPIO header). You'll always find some orientation of the nut where it clears all the parts. Hold it in this orientation, then tighten the screw up from the bottom. The board will then be neatly sandwiched between the two nuts!

On the Pi Zero especially, you'll need to do this just a few turns at a time, alternating between each screw...you can't crank down each screw all the way because they bind as the board gets tilted.



Here's how it looks when properly installed. Nuts are flush with both sides of the board, not pinching down on components. And the board is elevated at just the right height for the SD card slot and side cutouts to work.



If using a Pi Zero...

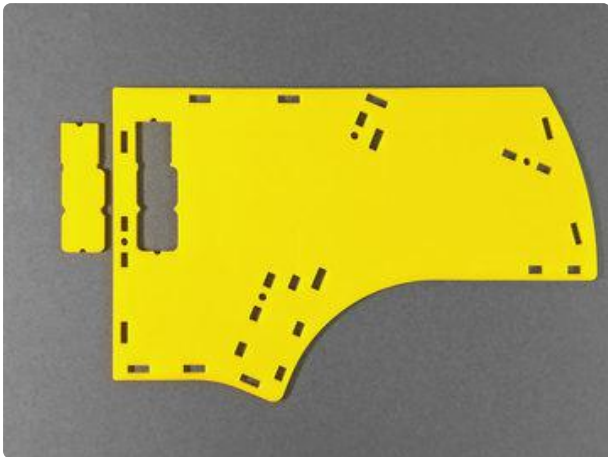

The left side of the Cupcade case has a cutout for the USB and Ethernet ports on the Pi 3 / Pi 2 / etc. If building with a Pi Zero, this leaves a big empty hole in the side.

This small piece, along with two screws and nuts, can be used to seal the hole. It's not vital to the system's operation, just looks nicer this way.

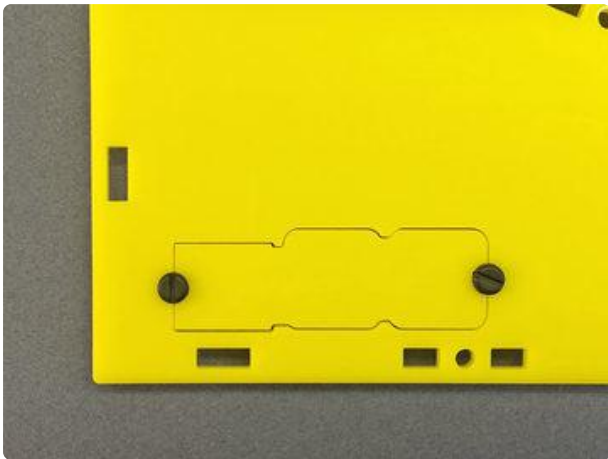

Cabinet Part 2

These directions are for the current "Gen 3" Cupcade kit.



Install the Arcade Bonnet atop the Pi GPIO header as you did during the dry run.

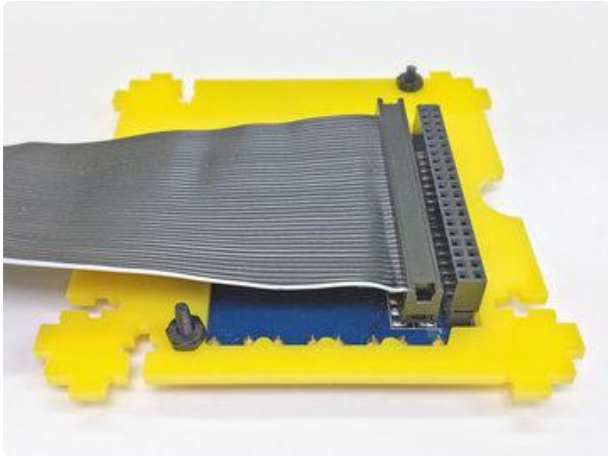

Plug one end of the 40-pin ribbon cable into the pin header on the back of the PiTFT.

Ensure the correct polarity. The white “pin 1” wire should run alongside the four buttons.

Do not plug the other end into the Arcade Bonnet yet.

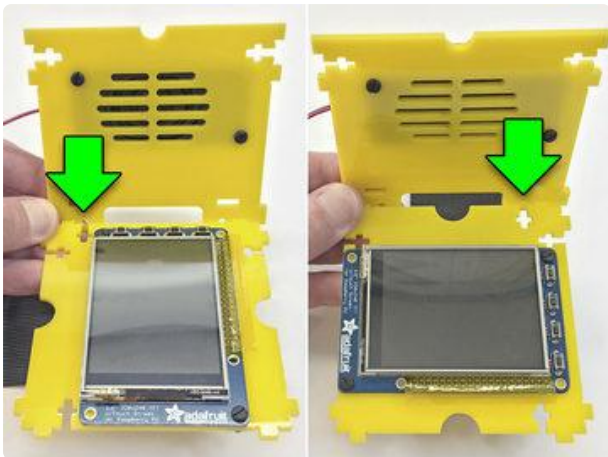

The screen fits into two slots at the bottom of the speaker grille.

Depending which way you’ve installed the screen — horizontal or vertical — one “T-slot” will be located at either the left or the right side.

For a VERTICAL SCREEN: the T-slot should be on the LEFT. If it’s on the right, you’ve got the screen piece upside-down.

For a HORIZONTAL SCREEN: the T-slot should be on the RIGHT. If it’s on the left, the screen piece is upside-down.



Feed a nut into the cross part of the “T,” holding it in place between thumb and forefinger.

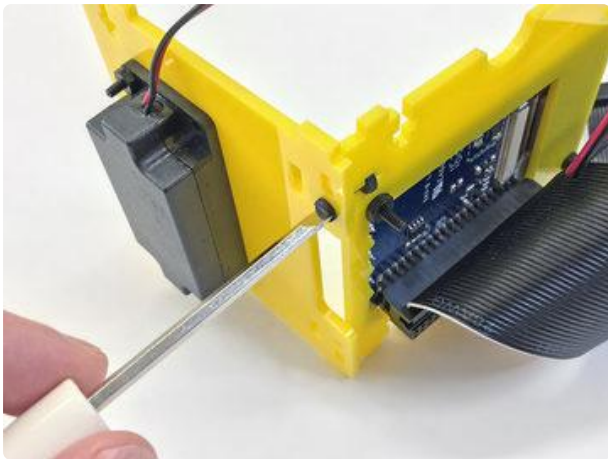

Bring the two pieces together and add a screw. This will pass through the plastic grille piece and into the nut.

Only one of the two speaker/screw holes is used, depending which way the screen is oriented. There's only one T-slot here. This is normal and by design.



The quick-connect wires for the “A” and “B” buttons pass through corresponding cut-outs in the joystick support piece.

All the same connections should now be made as they were during the dry run...

- Speaker wires connect to the screw terminals on the Arcade Bonnet.
- Button quick-connects (4) go to the sockets along the same side of the Bonnet. They don't need to go in any particular sequence, we'll map that out in software later.
- Four jumper wires from the joystick (Vcc, Xout, Yout, GND — Sel is not used) go to the Arcade bonnet ANALOG header (3V, X, Y, G respectively).
- PiTFT ribbon cable plugs into the Arcade Bonnet stacking header, observing the correct polarity (white wire should be nearest the SD card end of the Pi board).

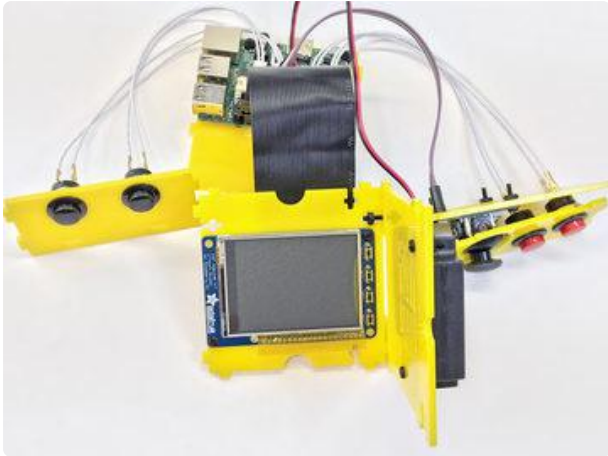

It's a bit of a jumble, but all the pieces should be linked up now. You can even do another dry run if you like...really not a bad idea.

As we proceed through the next steps, you might need to disconnect and reconnect some wires to wrestle things into position.

The joystick jumper wires are especially susceptible to pulling out during the next phase. If you have a hot glue gun, not a bad idea to tack them in place at both ends.

Cabinet Part 3

These directions are for the current "Gen 3" Cupcade kit.

The case uses the "T-slot" assembly technique, with #4-40 nylon screws and nuts. You saw one of these when joining the screen and speaker pieces.



Unlike that first slot, the remaining T-slots will be too deeply recessed to reach with fingers. Instead, you'll need some masking tape to temporarily hold each nut in place.

Doesn't matter if it's the blue or tan type, but it does need to be masking tape. It has a relatively weak grip and doesn't leave residue behind.

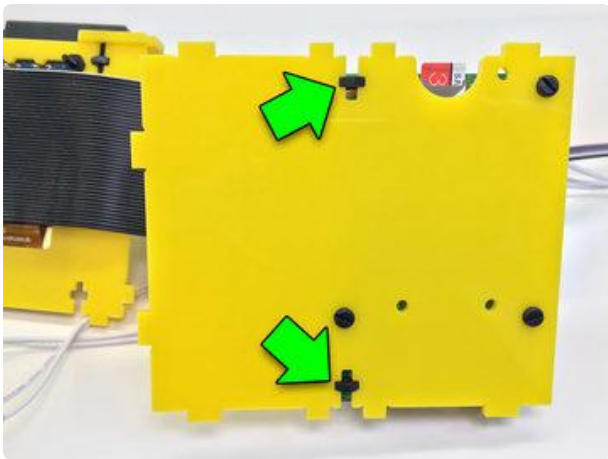

If using a Pi 3 or similar form-factor board, slide a nut into these two T-slots from the underside. The board will block them from slipping out the other side.

Cover each with a small piece of masking tape to keep them from falling out the front. The nuts should be captured in place now.

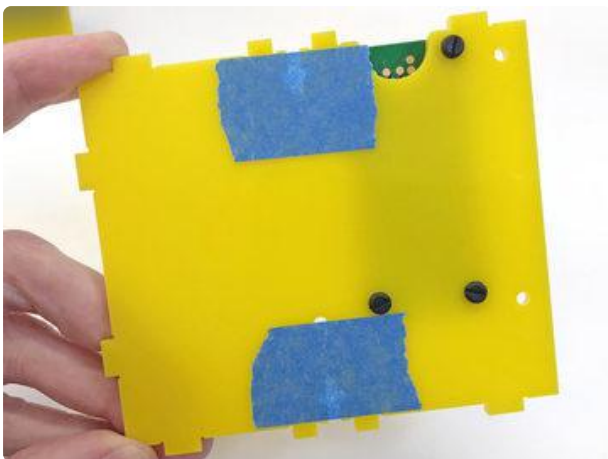
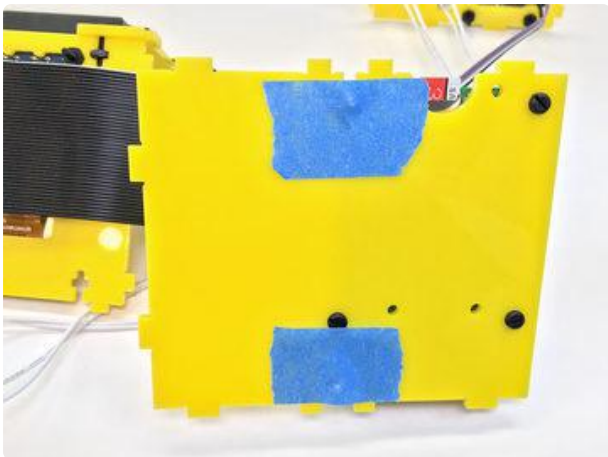

If using a Pi Zero, the sequence is a little different. Apply the tape first to the bottom face of the base piece, covering the two T-slots. Then, from above, slide a nut into each of the two slots. Really press them in to make sure they're making good contact with the tape.

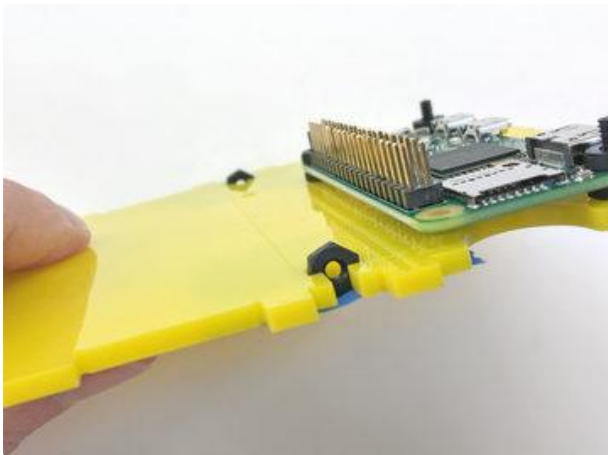

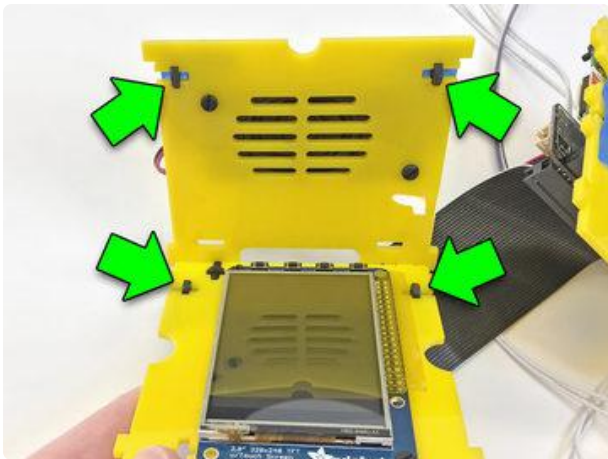

On the speaker/screen combo there's four T-slots total, two above the speaker, two above the screen.

Procedure is the same: apply tape over the T-slots from behind, then press nuts into place from the front.

If the screen piece doesn't have T-slots in these positions, it's probably turned 180° from how it should be...go back to the "Cabinet Part 2" page and check the assembly instructions there.

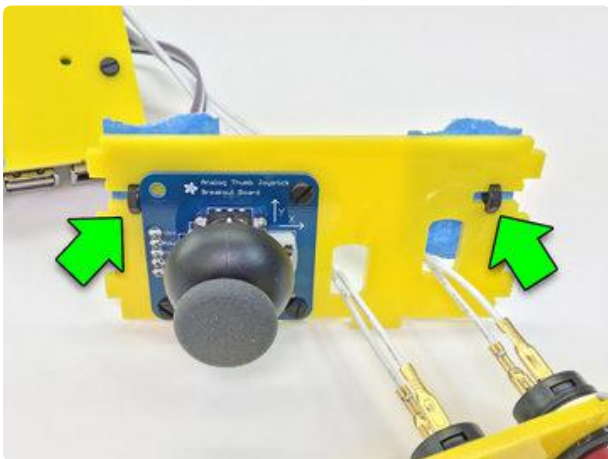

And once more for the joystick support. Two pieces of tape from behind, two nuts from the front.

There should be 8 nuts and tape bits at this point.

Okay, the Tricky Part...



Set one of the large side pieces flat on your work surface. Either one is fine... we're using the right side here.

Hey! That wasn't so hard. Wait for it...

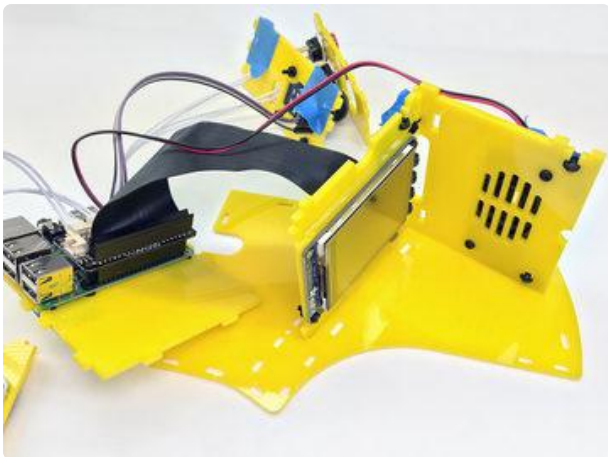

Take the jumble of parts and try to (roughly) align the tabs on the speaker grille, screen and joystick supports with the corresponding holes in the side piece. They probably won't stay in those holes for very long, but at least you'll know where they belong.

Start to place other elements vaguely in position: Pi near the bottom, buttons near the front. Tabs into holes.

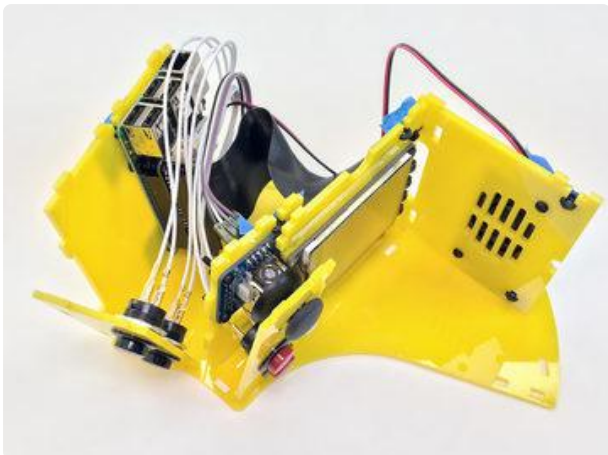

(The second photo shows the front black-buttoned piece slotted into place. While you can do this at this stage, it's not necessary. Focus on the parts with T-slots. We'll show how to insert all the non-T-slotted parts later.)

If you find your wires getting tangly again, it's okay to disconnect and re-route them.

And so begins the interpretive dance called Sealing Up the Cupcade Case...

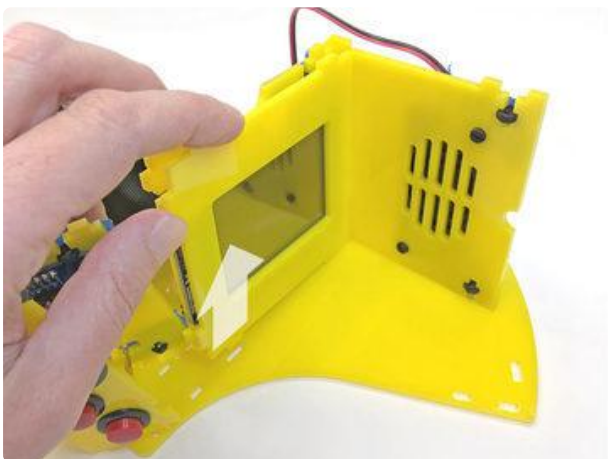

Pivot the screen support piece up slightly, fit the screen bezel into the slots on the speaker grille, and lower it all back into place.



Fit the joystick and button supports into their own slots as you're working on this section. Use masking tape to hold these four pieces in alignment.

Notches along the top edge of the button support should align with tabs on the screen bezel. If not, your button piece was assembled upside-down. Remove the quick-connects, unscrew the buttons, turn the piece over and reassemble.



The trick now is to pick the whole thing up just enough to feed these two screws through their corresponding holes in the side.

The screws don't need to be tight...in fact a little "give" is helpful at this stage. They just need to catch the nuts that are taped in place.

Some of the acrylic parts will fight a bit and not fit into their slots. Poke a small screwdriver through the hole and try to nudge these parts the right way.

If this is a dexterity challenge or you have smaller hands: rather than installing screws from below, remove the masking tape from the prior step and try fitting the side into place from above. Once the screws catch, you can turn it over and proceed through the same steps (just reversing right and left). Another approach is to scoot the whole assemblage just enough off the edge of the table to reach the screw holes from below (one at a time).



A third screw installs from the side at the top of the speaker grille piece.

A fourth screw holds the Raspberry Pi base.

You can now remove the joystick-and-screen-aligning tape from a couple steps prior. Only this tape! Keep the other tape (holding nuts) in place for now.

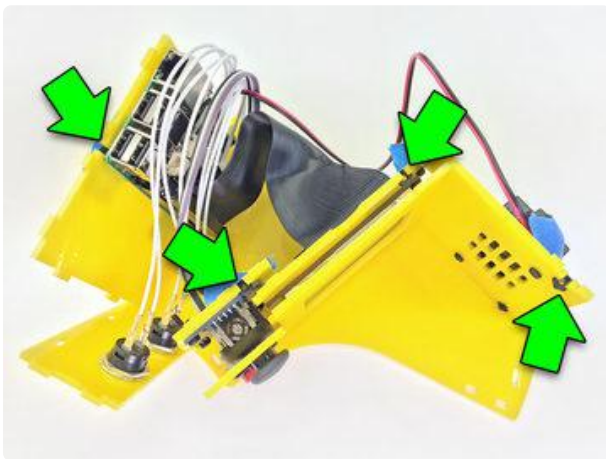

Now to repeat these four fasteners on the opposite side.

Make sure all four nuts are still held in with tape. If any have fallen out, press them back into place.



Now set the other side piece on top, roughly in position. I can guarantee the tabs won't all fit. That's okay, we'll align things one at a time...

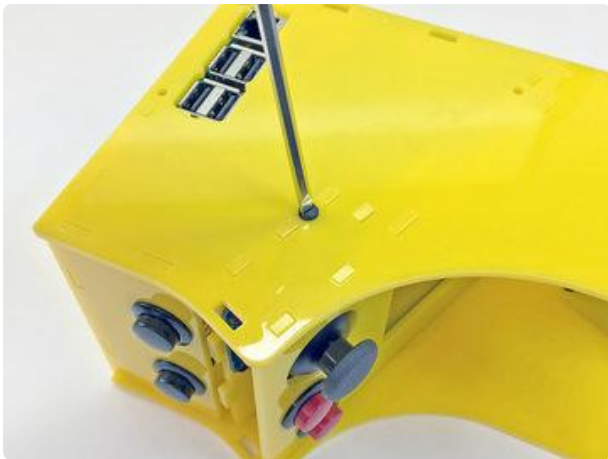

Here I'm starting with the joystick area... but you might want to start with the base piece instead; it has the fewest interferences. It's only because I've done this a few times and have the hang of it.

Get the tabs and holes aligned for nearby parts, then insert a screw. Do not crank it down...a loose fit is fine, just so it has a good hold on the screw.

Again, it's okay if the piece with the black buttons isn't in position yet. Focus on the T-slot pieces that require screws. We'll get the rest later.



Work your way around the case, aligning the tabs closest to each hole and then inserting a screw, four in total.

You may need to nudge each piece into position using the tip of the screwdriver through the slots, or with a finger from behind (when it can fit).



All screws now in place. Victory!

You can remove all the tape that was holding the nuts in place. Some of these will be deeply recessed; you might need tweezers to reach them.

Now gather up the remaining case parts, the ones with no T-slots...

Cabinet Part 4

These directions are for the current "Gen 3" Cupcade kit.

To fit the remaining pieces, it's necessary to ease up on some of the case screws...but only slightly, and one or two at a time.

If unscrewed too far, the nuts can fall off inside the case. Then you'll have to dismantle the case and go back several steps to rebuild everything. That's no fun, so proceed carefully!

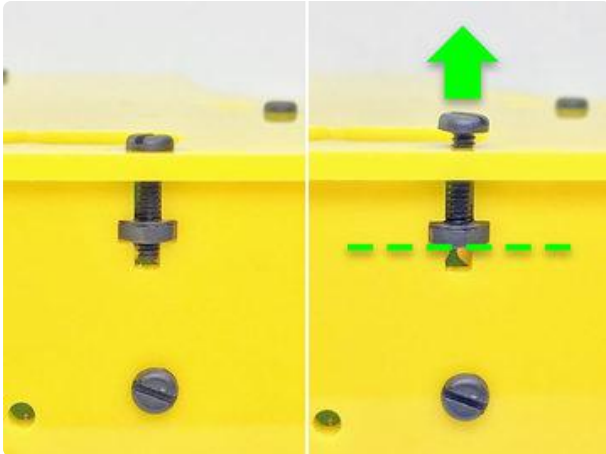

Idea is to loosen one or two of the screws nearest each piece as it's installed. Either right or left side of the case, doesn't matter. Sometimes both, if you need a little extra.

The tip of the screw should be flush with the face of the nut.



Loosen a screw and lift up the case side to install this front piece just below the joystick and buttons. There should be just enough clearance and flex for this to happen. Bend too far and you'll crack plastic or pop the head off a screw.

This is also a good moment to install the black-buttoned front piece, if you haven't already. May need to loosen the base screw a bit as well.

Once in place, the screw(s) can be re-tightened. They should be snug, but not overly tight or you'll pop a head off.



Loosen this screw to insert the cabinet marquee and “roof” piece, then re-tighten.

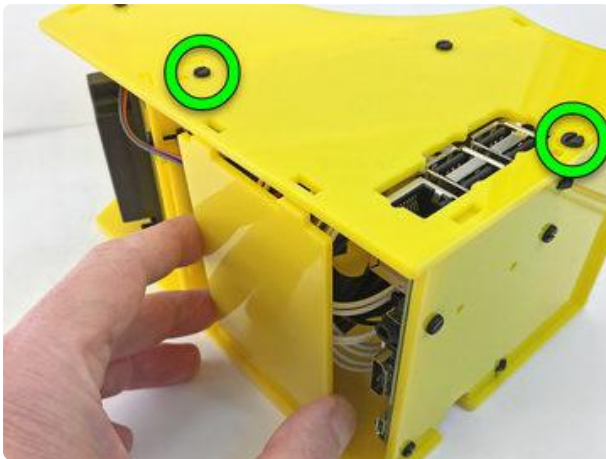

Get all the wires stuffed inside the case. Check the joystick jumper wires, which may have pulled free.

If everything fits and is still connected, loosen this screw nearest the back (and maybe the base screw a bit as well), lift the side and pop in this back cover.

The roof and back pieces look very similar, but each has notches that will only fit in their specific positions.



Taa-daah! The case should stand on its own now. Go around checking that all the screws are securely in place.

My Cupcade rocks back and forth when stood up.

Loosen all 8 screws on the sides. A mere 1/4 to 1/2 turn or so...we're not dismantling the case, just realigning things.

Stand the case upright and press down gently on top, so all four corners make contact with the table. With your free hand, tighten each of the side screws back as it was.

Configure Input

We initially configured the system to work with a USB keyboard for input. A few more steps are needed to get the onboard controls fully working.

Plug in a USB keyboard and connect power to the system. It should boot just like during the dry run, with the RetroPie main menu appearing in a minute or so.

Using the keys that you configured during the “Raspberry Pi Setup” process, navigate to RetroPie’s “Configure Input” screen and select “Yes” when prompted.

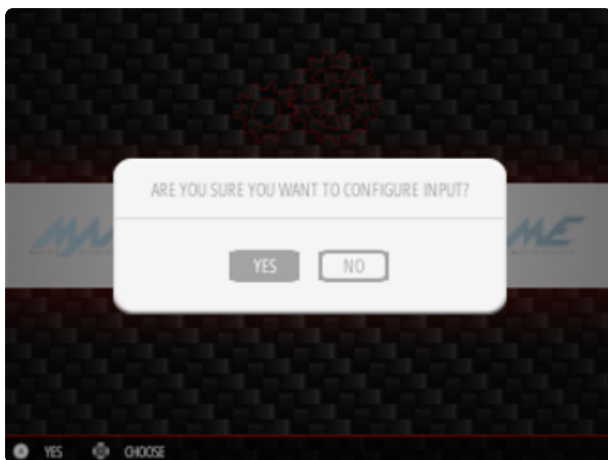

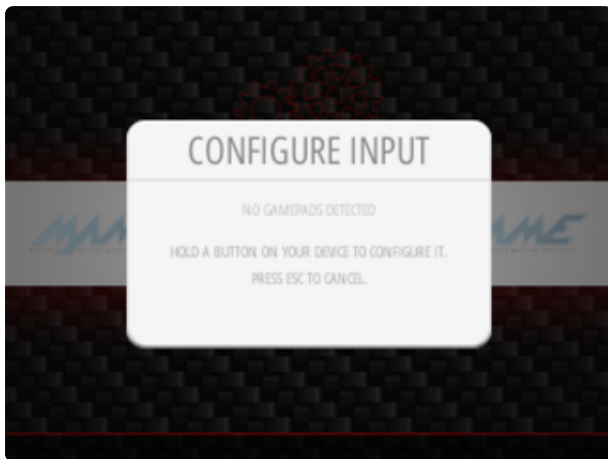

Hold down any of the Cupcade’s buttons for a few seconds and you’ll see the system respond KEYBOARD. (This is normal — the Arcade Bonnet software emulates a keyboard.)

Then you’ll get to a configuration screen starting with the D-pad directions. Move the Cupcade joystick as indicated for each of the four directions.

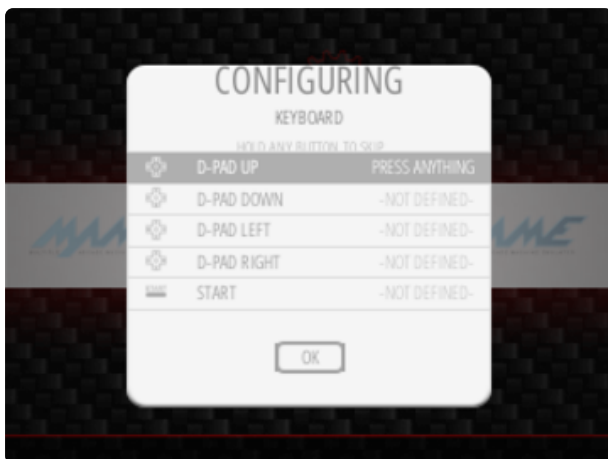

For the “A” and “B” buttons, press the red buttons adjacent to the joystick. “A” is usually the primary fire or jump button in most games, while “B” is a secondary function such as bomb. Pick either button to be A or B, whatever seems comfortable (you can always come back to this menu and re-do the assignments later).

For the “Start” and “Select” buttons, press the black buttons on the front of the cabinet. Again, either position as you like.

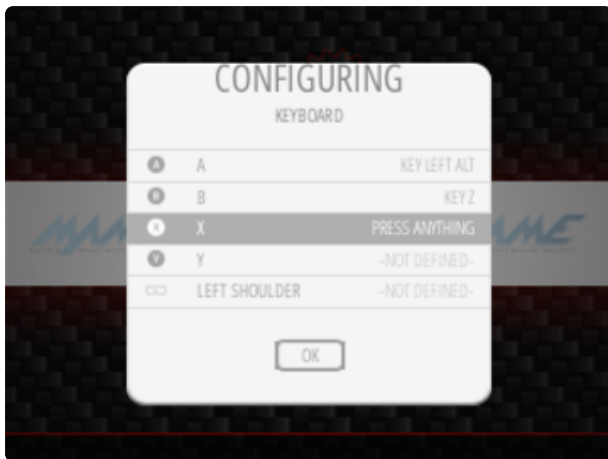

Keep going until it asks for the “X” button...

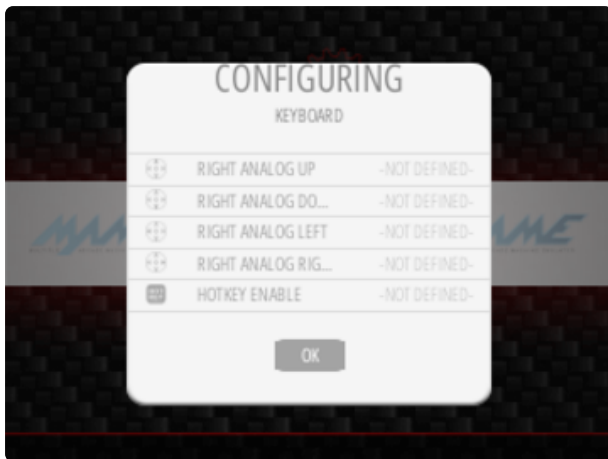

Cupcade doesn't have this many buttons! It's mostly designed for simpler oldschool games. So you have a choice...

- If you hold down one of the Cupcade's buttons for a few seconds, that item will be skipped.
- Or you can assign these functions to keys on the USB keyboard, which you'll need to have plugged in for games that require these extra inputs.

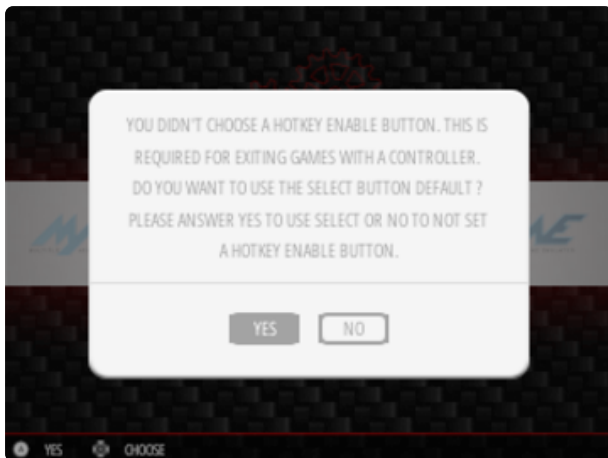

Continue through the whole list...about a dozen items to the end. You'll be asked about a hotkey enable button. Select the default “Yes” here — meaning you'll press the Start+Select buttons together to exit a game and return to the RetroPie menus. (You now click “Yes” by pressing the “A” button.)

That's it! You should now be able to operate the system with just the Cupcade controls. The USB keyboard is no longer a necessity.

Gen 2 Kit

You probably don't have one of these unless you have a very old kit!

The directions on the next page relate to the second-generation (“Gen 2”) Cupcade kit. If you have a first- or third-generation kit (Gen 1 or 3), follow links in the left column to the corresponding section.

If you bought your kit from Adafruit recently, it’s the current Generation 3 kit. There might still be some earlier kits elsewhere out there in the pipeline. The differences are most easily spotted in the electronics...

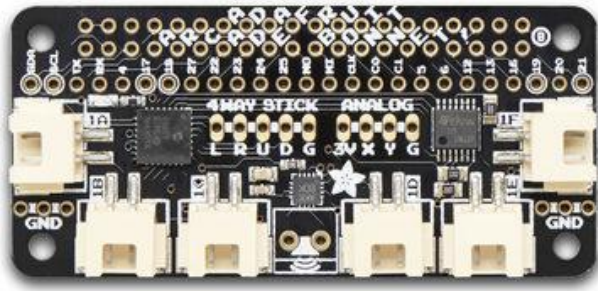

Generation 3 (current) Cupcade kits include the Adafruit Arcade Bonnet with the 40-pin GPIO header as used on current Raspberry Pi boards.

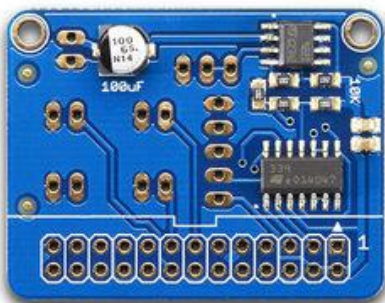

Generation 2 kits used the Cupcade Adapter Board with the 28-pin GPIO header as used on the Pi 1 Model B.

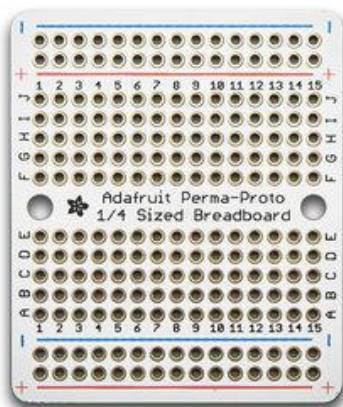

Generation 1 kits had you solder up several components and wires on an Adafruit Perma Proto board.

Don't feel left out if you're running a prior kit! Still entirely playable and in fact we're using the exact same software across all of them. The changes are mostly to accommodate new hardware as supplies of the original Pi 1 Model B dried up.

Interface Board

These directions are for the "Gen 2" Cupcade kit. Earlier Gen 1 kits had a DIY interface board. You probably don't have one of these unless you have a very old kit!

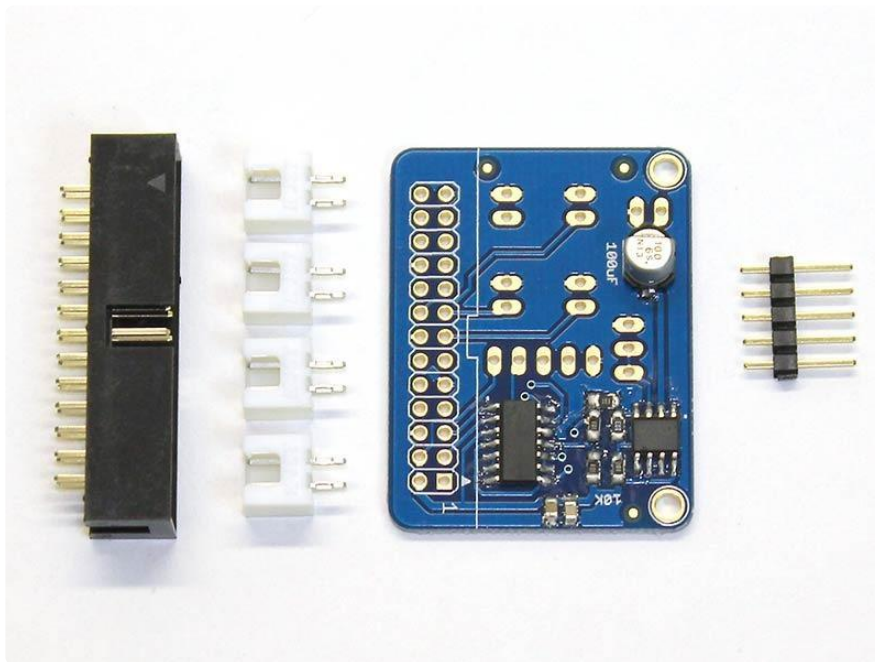

A small circuit board — specially designed just for Cupcade — features a joystick adapter circuit and a small audio amplifier. Just a few through-hole components need to be soldered.

Different parts will get soldered on opposite sides of this board. Labels and outlines (along with the photos here) should make it clear where parts are inserted.

But first...a few wires need to be cut to about six inches long. You don't need a ruler for this...the ribbon cable is just the right length. Unplug it from the Pi and PiTFT and use it for reference.

This isn't rocket surgery, don't worry if wires aren't precisely the right length. Six-ish inches is fine!

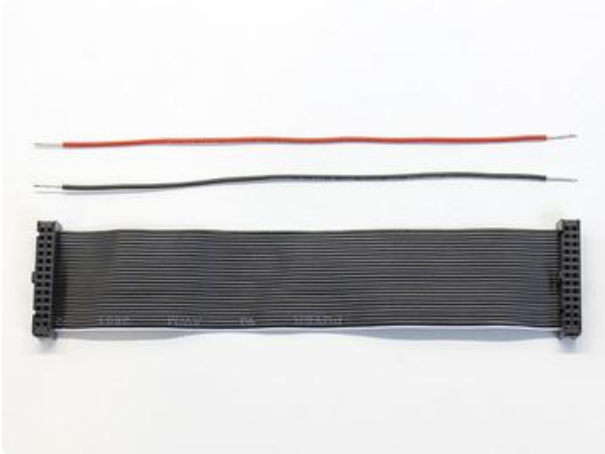

Cut two (2) wires about six inches long and strip about 1/4" of insulation from both ends.

24 gauge stranded wire is ideal. A little thicker or thinner is okay, as is solid-core wire...stranded is simply more flexible.

Color-coding the wires likewise isn't essential; one color will suffice if that's what you have.



Solder one end of these wires to the connection points on the speaker.

Optional: you can keep these wires together with a bit of heat-shrink tube if you like.



Cut the audio cable so it's a little longer than the ribbon cable.

Strip about 1" of the outer jacket only to reveal the three wires inside: two are insulated, the third is bare copper.

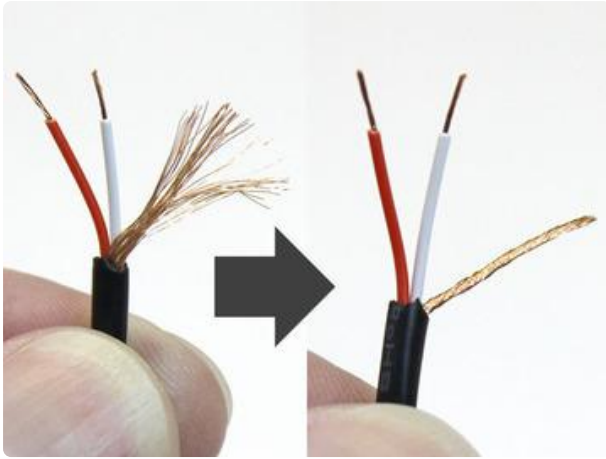

Strip 1/4" insulation from the two inner wires. Twist the stranded copper wire into a tidy bundle.

Some headphone cables have red and black wires rather than the red and white shown here. This is OK, it all works the same. Red is the right channel, black or white is the left channel, copper is ground.

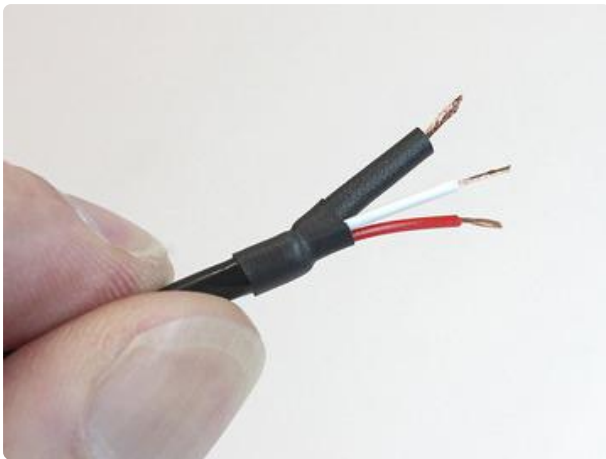

That bare copper wire on the audio cable is a problem...it might contact metal parts in the vicinity. We must insulate!

Slide a small piece of heat-shrink tube a few inches down the cable (around the whole thing, not just the copper wire).

Slide a second piece of heat-shrink tube over just the copper wire and heat it up. This covers most of the wire, but there's still a tiny gap.

Slide the first (un-shrunk) piece back up so it covers the gap, apply heat.

The four 2-pin JST sockets, plus the 5-pin joystick header, are inserted on the "CUPCADE" side of the board and are soldered on the back side.

It's easiest to do the JST sockets first, one at a time. You can temporarily hold them with a little tape, or place each one "legs up" on the table and lower the board in place, then solder.

Notice how the two rows sit "back to back." This makes it a little easier to unplug the connectors later.

The 26-pin Raspberry Pi header then mounts on the underside of the board, with the pins soldered on top. Make sure the notch on this header matches the outline on the board!

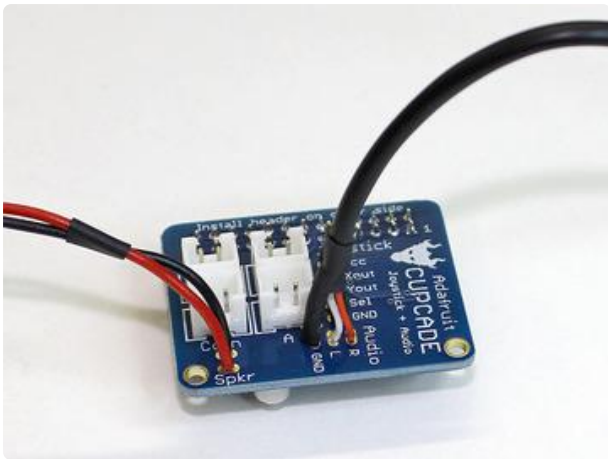

The speaker and headphone wires then connect to corresponding points on the board. The speaker wires go to the two “Spkr” points, headphone to the three “Audio” points: red wire to “R,” black or white wire to “L,” copper wire to “GND.”

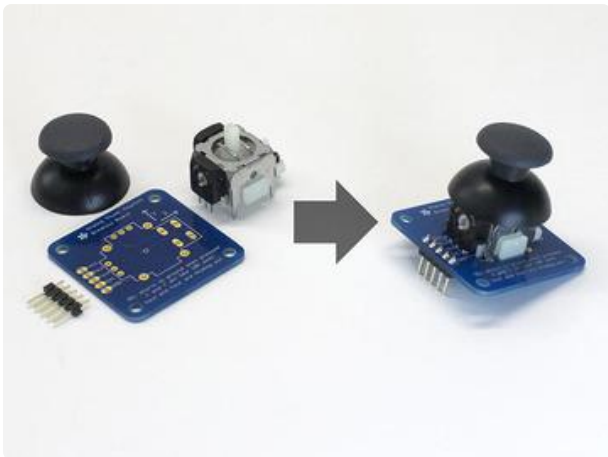

Assemble the analog thumb joystick. Some of the pins may be a little bent from shipping and need to be nudged into place. The “hat” simply presses into place.

Install a 5-pin header from below.

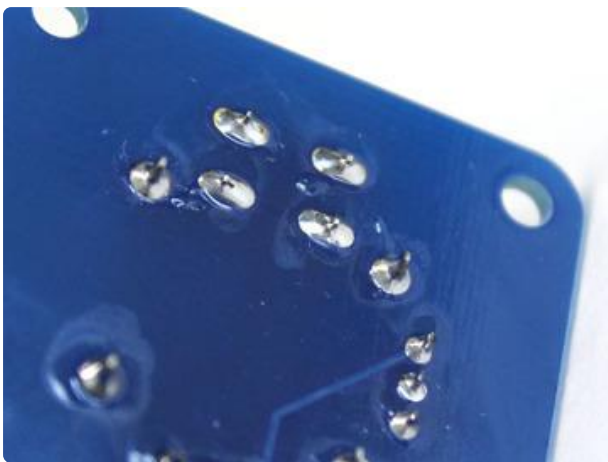

Make sure all your solder connections are smooth and clean, like tiny Hershey’s Kisses®. There should be no solder balls or bridges, no gaps between pins and their corresponding pads.

Switch off your iron, all the soldering’s done now!

Gen 1 Kit

You probably don't have one of these unless you have a very old kit!

The directions on the next few pages relate only to the first-generation (“Gen 1”) Cupcade kit. If you have a second- or third-generation kit (Gen 2 or 3), follow links in the left column to the corresponding section.

If you bought your kit from Adafruit recently, it’s the current Generation 3 kit. There might still be some earlier kits elsewhere out there in the pipeline. The differences are most easily spotted in the electronics...

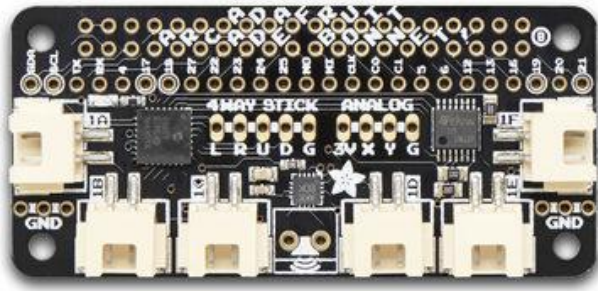

Generation 3 (current) Cupcade kits include the Adafruit Arcade Bonnet with the 40-pin GPIO header as used on current Raspberry Pi boards.

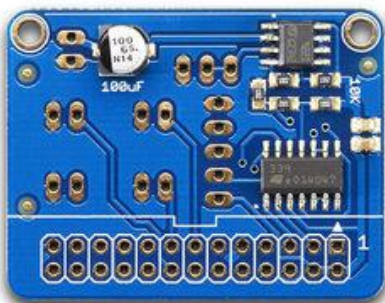

Generation 2 kits used the Cupcade Adapter Board with the 28-pin GPIO header as used on the Pi 1 Model B.

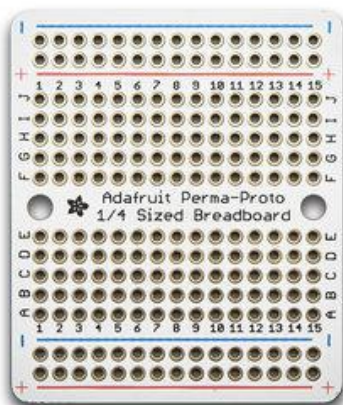

Generation 1 kits had you solder up several components and wires on an Adafruit Perma Proto board.

Don't feel left out if you're running a prior kit! Still entirely playable and in fact we're using the exact same software across all of them. The changes are mostly to accommodate new hardware as supplies of the original Pi 1 Model B dried up.

Beta Board Part 1

These directions are for the original "Gen 1" Cupcade kit. Later generations of the kit are described in their own sections. You probably don't have one of these unless you have a very old kit!

It's a tight squeeze, but everything just fits on a 1/4 size Perma-Proto board!

The Perma-Proto circuit is neatly divided into two sections. The left side is a basic audio amplifier for the speaker. The right side interfaces the analog joystick to the Raspberry Pi's digital-only GPIO. The line down the middle connects the two ground rails across the board.

This diagram shows a rectangular Pi Cobbler; we'll actually be using a "T" cobbler. Same functionality, same pins, just a different shape than shown here.

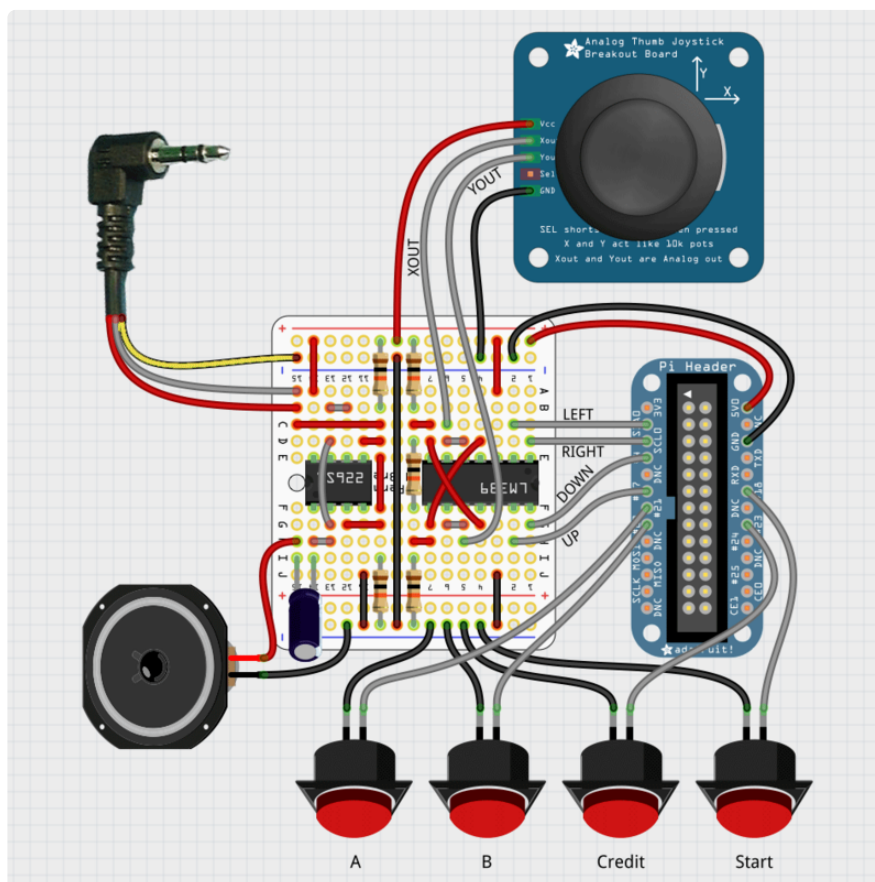

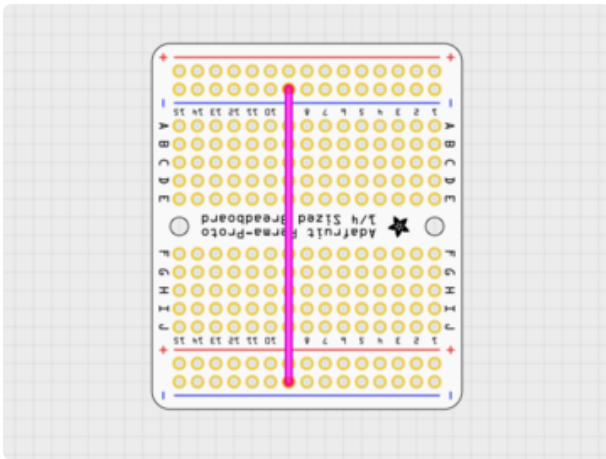

The Perma-Proto is turned around, with the labels upside-down. It's fine, this orientation just makes our circuit easier to lay out.

Cut a wire a little over 2 inches long and strip the ends. Run this along row 9 between the two ground (blue) traces.

Aside from joining the ground traces, this provides a nice visual separation of the two unrelated parts of the circuit. It's okay if this wire is a little longer and doesn't lie flat; strictly a visual thing.

Make certain you're connecting the ground (blue) traces, not one or both of the positive (red) traces.

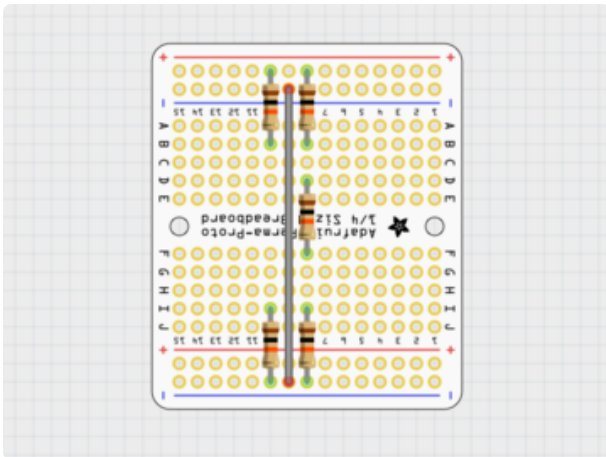

Install five 10K resistors (brown-black-orange) in the positions shown, immediately to the left and right of the ground wire. Two go on the left (audio) side, three on the right (joystick) side.

The two resistors at the top connect to the positive (red) trace, while the two at the bottom connect to ground (blue). The final resistor bridges the center gap on the right side.

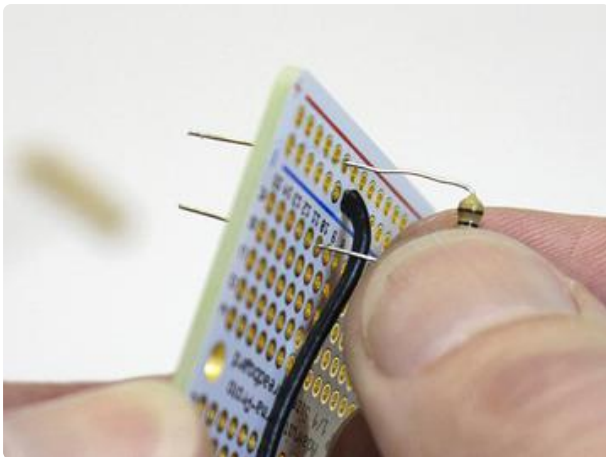

Bend the resistor legs so they're parallel like staples, insert them into the Perma-Proto board so they're sitting flush and then bend the legs on the back outward to hold them in place for soldering.

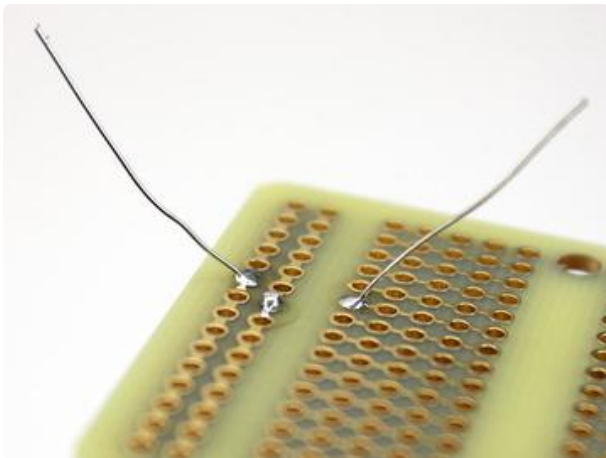

After soldering, the legs can be trimmed close to the board. Save these trimmings for the next step — they make handy jumpers!

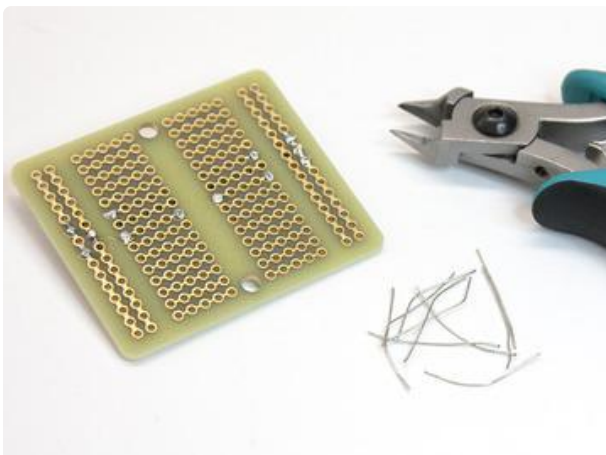

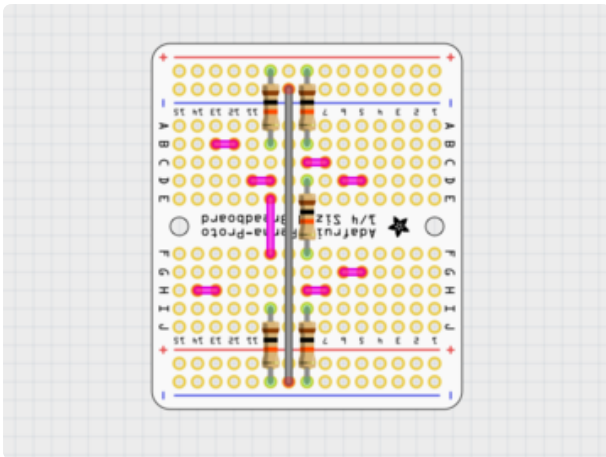

Eight short jumpers are now installed in the positions shown in pink. Most of these are very small, joining adjacent pads. We can use the un-insulated clippings from the prior step because no other conductive traces are crossed.

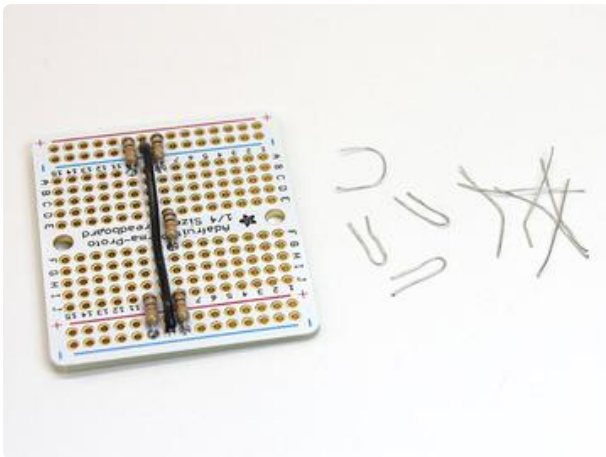

Install these similarly to the resistors: bend each jumper into a small "staple" shape, insert it through the correct holes (triple-check!) and bend the legs outward to hold for soldering.

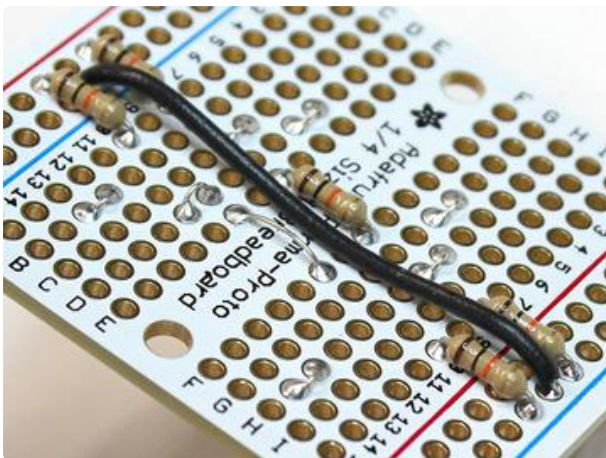

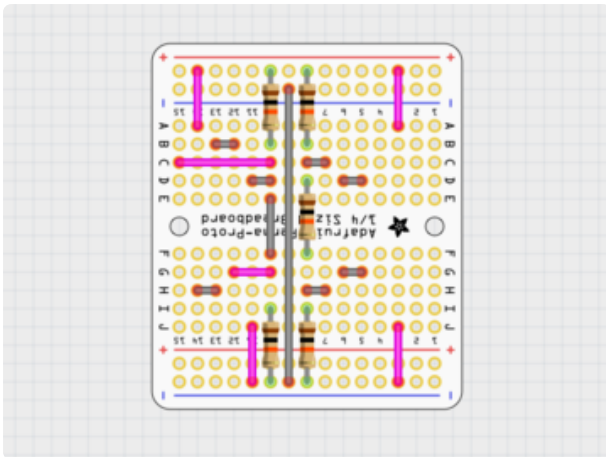

Six more jumpers are now installed as shown in pink (prior steps are gray). Because these jumpers cross other traces, they should be cut from insulated wire, do not use the resistor clippings for this step!

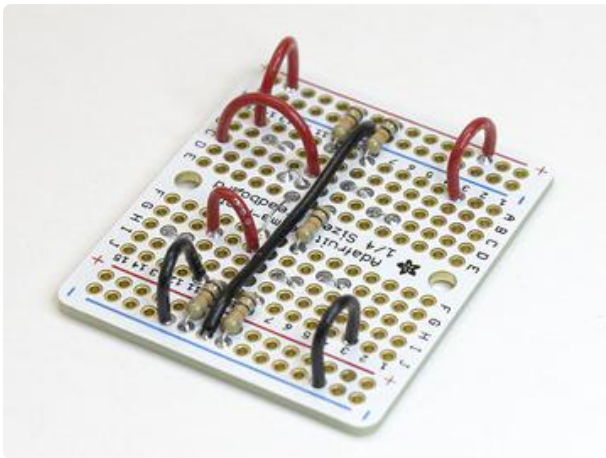
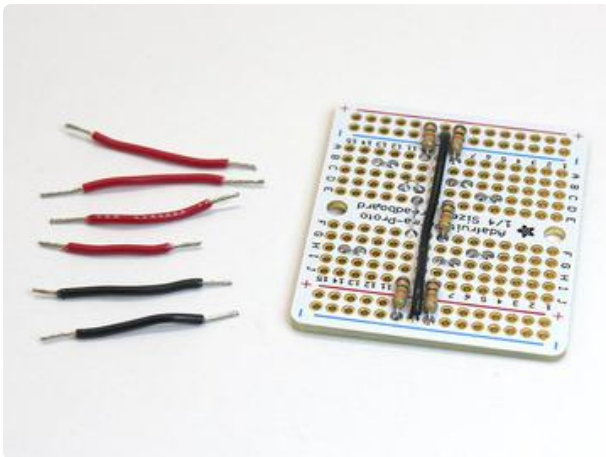

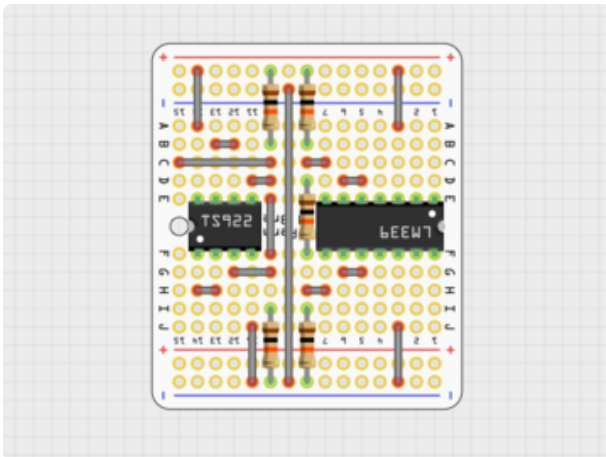

This diagram shows where the TS922 amplifier and LM339 comparator ICs will be installed later. In their place for now we'll install sockets, then add the chips after everything else is complete.

Make sure you get the 8-pin socket in the correct position — it's inset by one row, not right at the edge of the board.

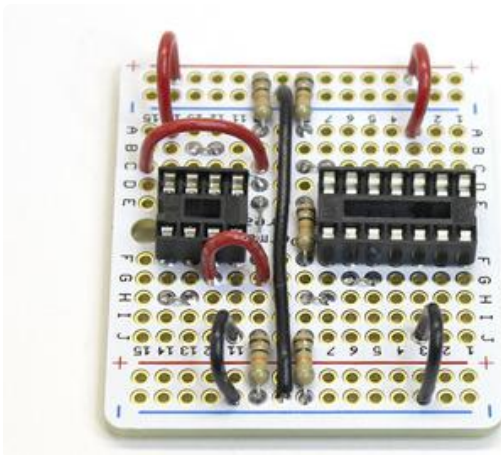

Note that the chips will be installed “back to back,” with pin 1 facing opposite edges of the board; they're not oriented the same way.

When soldering sockets, use only enough solder to make a good connection between the pins and vias. Don't keep adding solder...you'll fill the socket holes and won't be able to insert a chip!

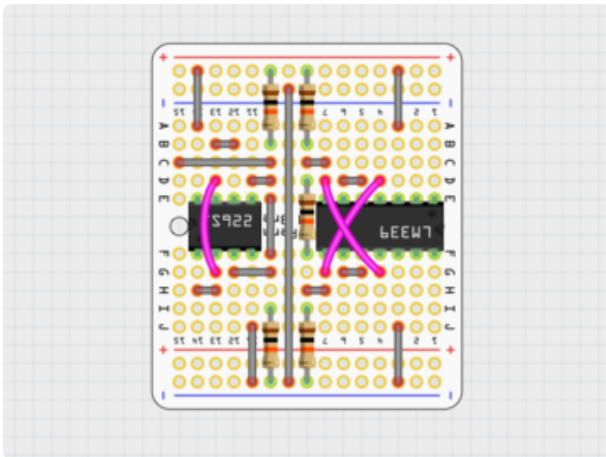

Three more jumpers are installed, cut from insulated wire.

These wires cross over the IC sockets. Do not follow a straight shot as depicted in the diagram — that's just to make the connection points more clear. The wires should actually be a little longer and will get bent around the sockets, so a chip can still be inserted.

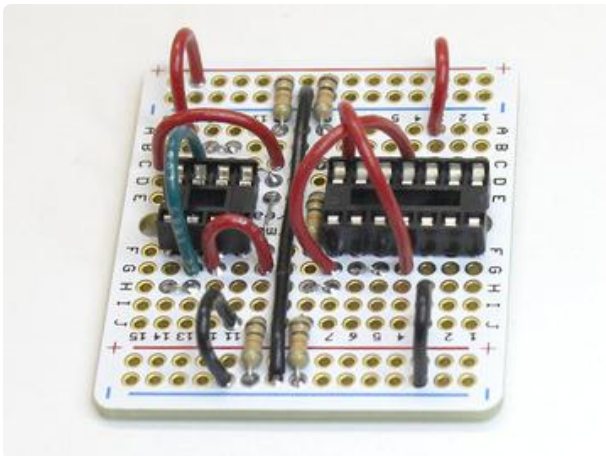
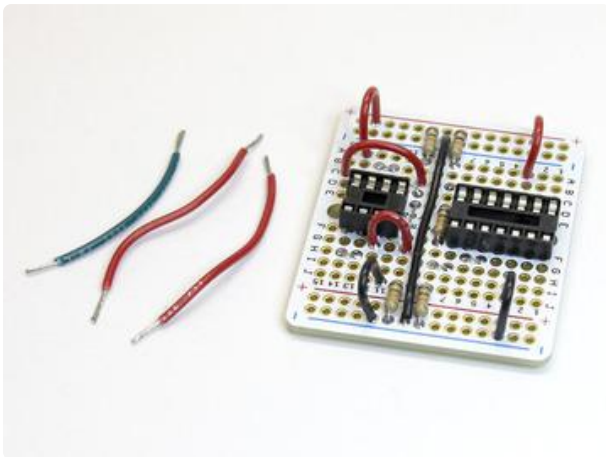

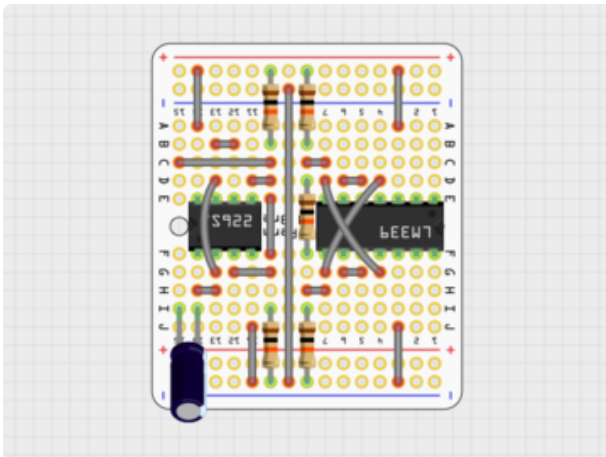

Install the 100 μF capacitor in the position shown.

In the photo, notice the wires now bent around the sockets. Don't add the chips yet, we'll do that later, after the rest of the soldering.

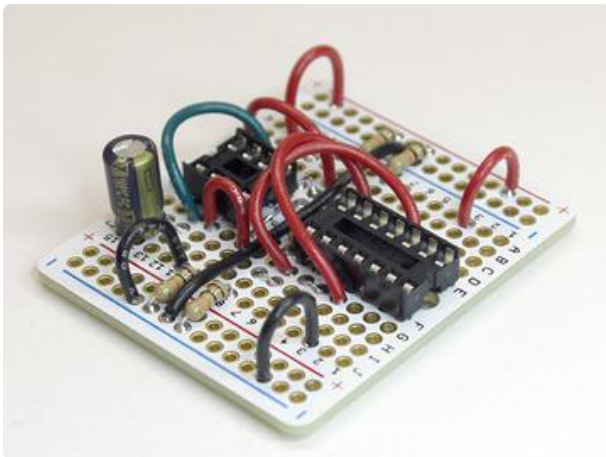

This is a good time to pause and double-check your work.

- Do your wires and components match the layout precisely as shown? Count the number of wires and components and the spaces between them.
- Are there any cold solder joints or shorted pads on the back of the board? Now's the time to repair them.
- Are all the wire ends trimmed?

If something is installed wrong, at best the circuit won't work as expected. At worst, the Raspberry Pi won't boot or could even become permanently damaged!

The circuit is 5 Volts but connects to the Raspberry Pi's 3.3V GPIO pins. Won't this fry the board?

The LM339 comparator outputs are When active, they connect to ground (0V). When inactive, they "float" (aren't connected to anything) and the Pi's own pull-up resistors register this as a 3.3V "high" signal. The unregulated 5 Volts (which we really need for the amplifier) never gets back to the Pi...assuming it's all assembled correctly, so please double-check everything!

Beta Board Part 2

These directions are for the original “Gen 1” Cupcade kit. Later generations of the kit are described in their own sections. You probably don't have one of these unless you have a very old kit!

This page is mostly prep work: measuring, cutting and stripping wires, making labels and bits of heat-shrink tube. Doing these steps carefully should make the next steps less troublesome.

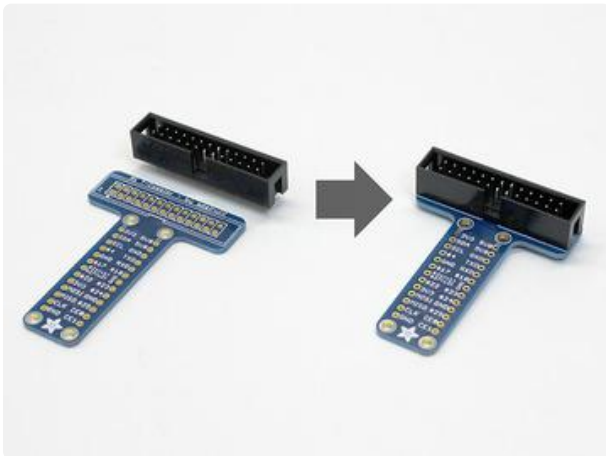

Install the male (pin) header on the Pi T-Cobbler.

Make sure the “key” (notch) is on the correct side; it’s marked on the silkscreen. It should face all the pin labels.

Do not install any other pin headers on the Cobbler! We’ll be soldering wires directly later.

Make sure to solder the socket on correctly. The socket goes on the same side as the text and the notch is pointed toward the Adafruit logo.

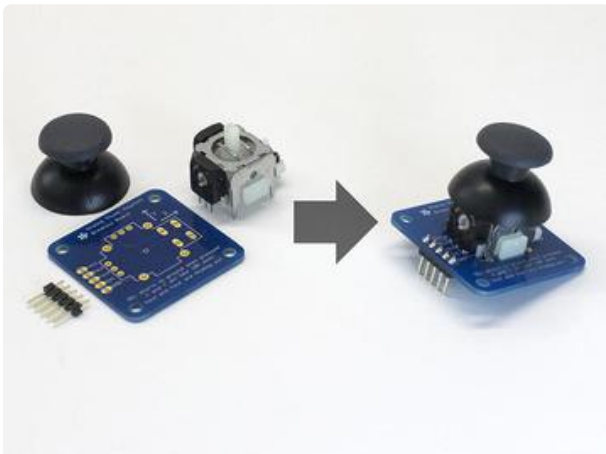

Assemble the analog thumb joystick. Some of the pins may be a little bent from shipping and need to be nudged into place. The “hat” simply presses into place.

Install a 5-pin header from below.

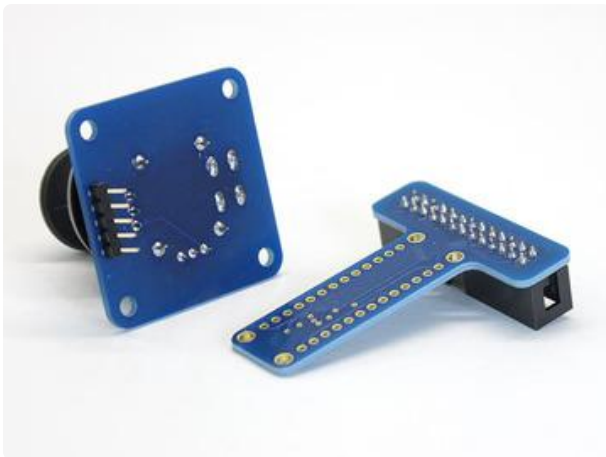

Make sure all your solder connections are smooth and clean, like tiny Hershey's Kisses®. There should be no solder balls or bridges, no gaps between pins and their corresponding pads.

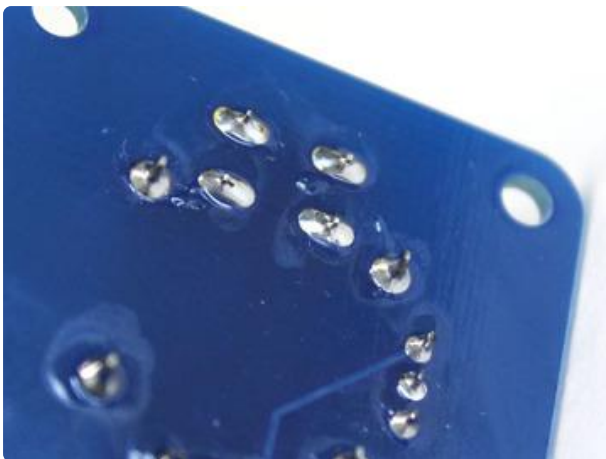

A whole mess of wires need to be cut to about six inches long. You don't need a ruler for this...the ribbon cable is a perfect size. Unplug it from the Pi and PiTFT and use it for reference.

This isn't rocket surgery, don't worry if wires aren't exactly the right length. Six-ish inches is fine!

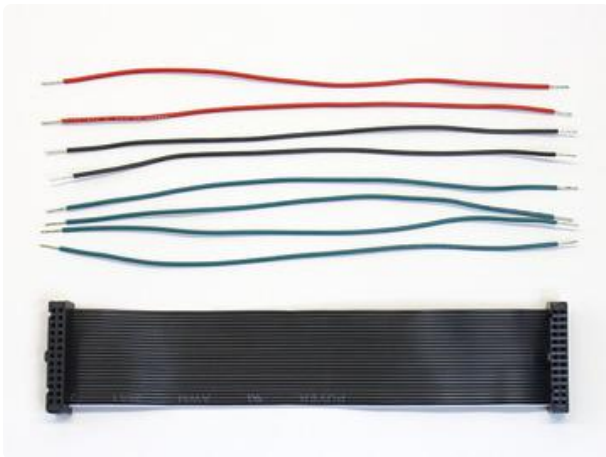

Cut eight (8) wires about six inches long and strip about 1/4" of insulation from both ends.

24 gauge stranded wire is ideal. A little thicker or thinner is okay, as is solid-core wire...stranded is simply more flexible.

If you have some different colors of wire, you can color-code these. Here we've cut two each red and black (for power), and four green (for signals). If you don't have different colors, that's okay, we'll also be labeling them in a bit.

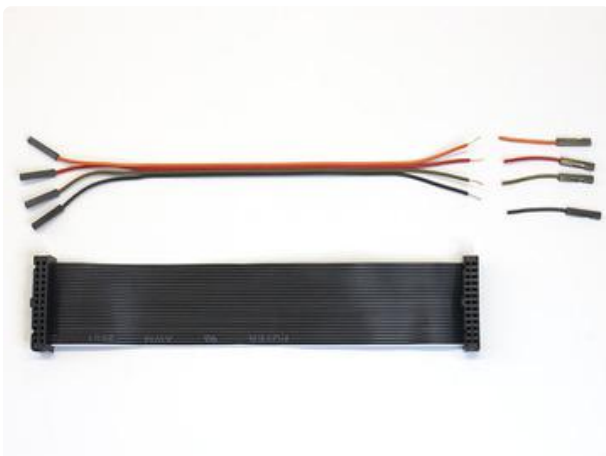

Clip one end off the 4-conductor jumper cable so it's a similar length. Separate the wires a little and strip about 1/4" of insulation.

The wire colors are random; don't worry if yours don't match the photo.

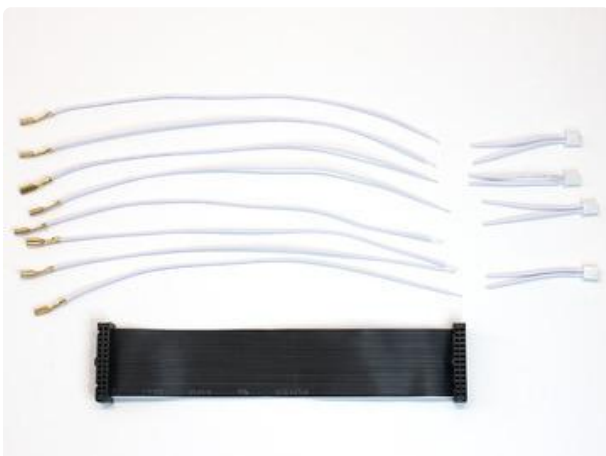

Clip the 2-pin plastic plugs off the button quick-connects. You should then have eight (8) wires with a metal spade on one end. Strip a little insulation from the other end.

Something about the composition of these wires is strange and slightly brittle, and you may have trouble with your first couple of tries stripping them. No problem...clip these a little long to start, and if the stripping goes badly, you can trim it off and try again.



Cut the audio cable so it's a little longer than the ribbon cable.

Strip about 1" of the outer jacket only to reveal the three wires inside: two are insulated (red and either white or black) and the third is bare copper.

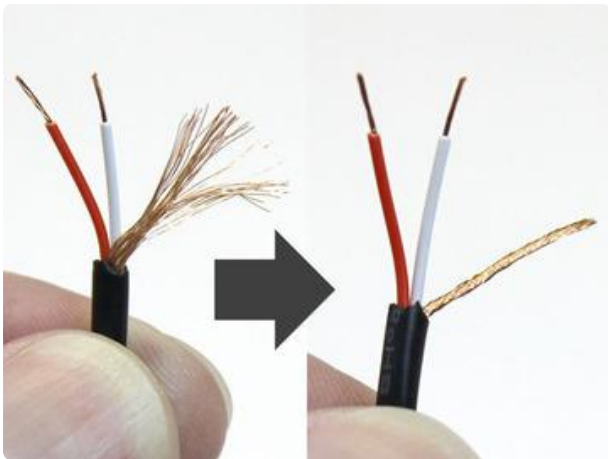

Strip 1/4" insulation from the two inner wires. Twist the stranded copper wire into a tidy bundle.

Some headphone cables have red and black wires rather than the red and white shown here. This is OK, it all works the same. Red is the right channel, black or white is the left channel, copper is ground.

Arts & Crafts Time!

Labeling the wires will make later steps much, much easier!

How you create these labels is up to you, depending on the materials and tools you have on hand. Ours are low-tech...masking tape and a Sharpie pen...but if you have a spiffy label maker, go to town.



Make 12 labels, something akin to this list:

- U (up)
- D (down)
- L (left)
- R (right)
- A (primary button)
- B (secondary button)
- X (joystick horizontal)
- Y (joystick vertical)
- + (5V)
- (Ground)
- ¢ (Coin insert)
- 1P (1 Player Start)

Each label has two symbols written on it, so it's readable from either side.

X and + look similar enough that you may want to underline them for directional clarity: X and +.

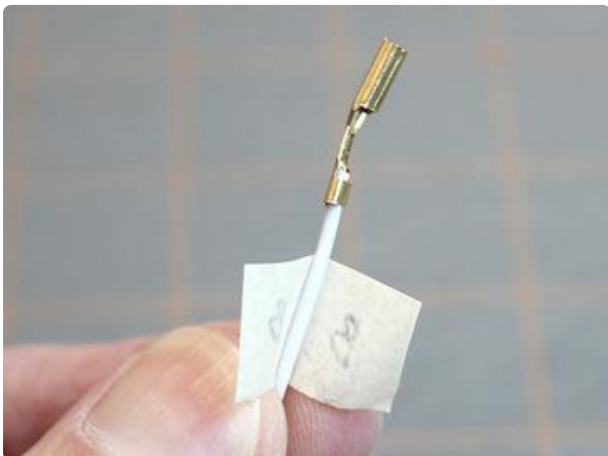

The labels wrap around individual wires, near the connector end. But not yet... don't just wrap willy-nilly...these each need to go on specific wires!

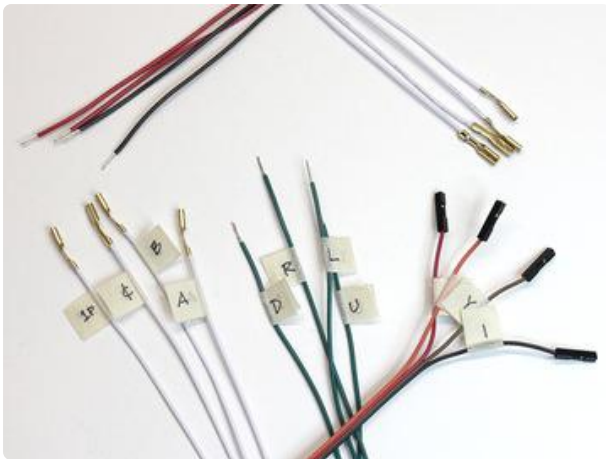

Four of the white quick-connect wires should be labeled with: A, B, C and 1P. The other four quick-connect wires do not receive labels.

The four conjoined jumper wires should be labeled with: X, Y, + and -.

Four of the plain wires should be labeled: U, D, L and R. If following our color scheme, these would be the green wires. The other four plain wires do not receive labels (unless you're using a single color of wire, in which case we'd suggest adding extra + and - labels to two wires each.)



Cut some short pieces of heat-shrink tubing. Ten should suffice, about 1/4" long. Keep a little in reserve for a later step.

These will be used to hold wire bundles together, preventing breakage.

Beta Board Part 3

These directions are for the original "Gen 1" Cupcade kit. Later generations of the kit are described in their own sections. You probably don't have one of these unless you have a very old kit!

Let's refer to this diagram again. The Perma-Proto circuit is done, now we're placing all the long wires.

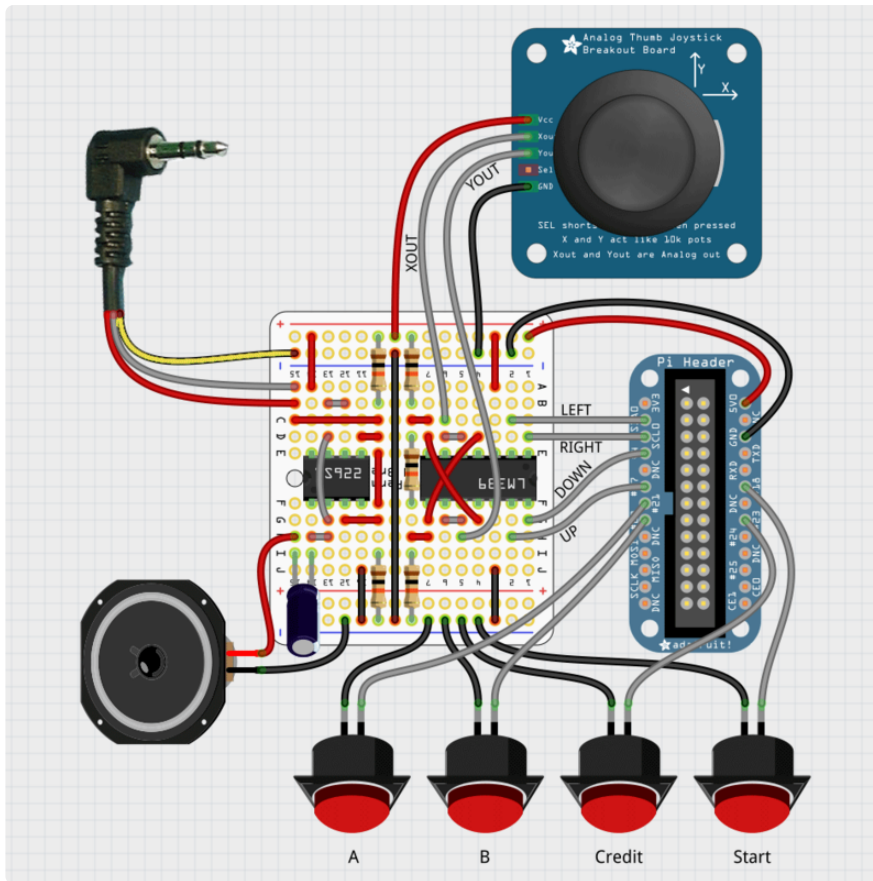

Button Wires

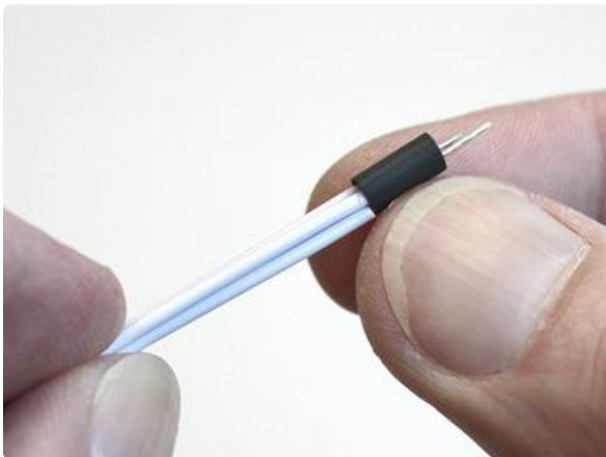

Gather up four quick-connects (the unlabeled ones) and squeeze the tips through a piece of heat-shrink tube.

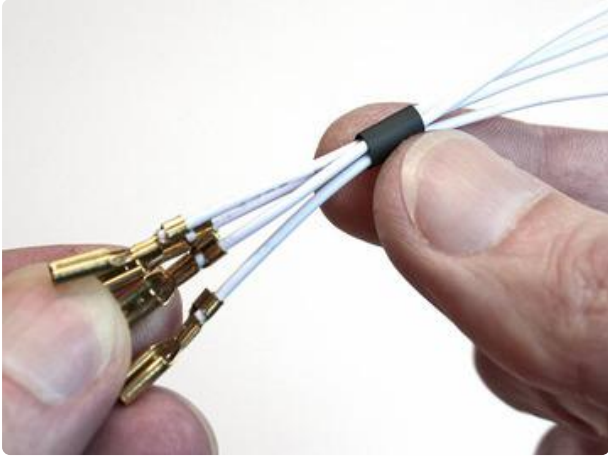

Slide the heat-shrink all the way down, near the metal spades, but don't shrink it yet!

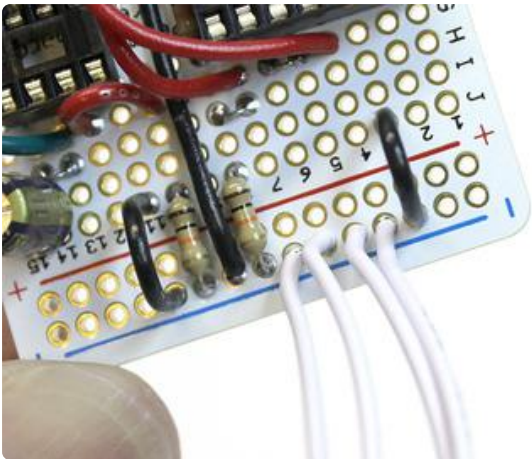

Solder the other end of these four wires to the lower ground bus on the Perma Proto board. The wires enter from the top and are soldered on the underside. Clip any excess wire protruding from the bottom.

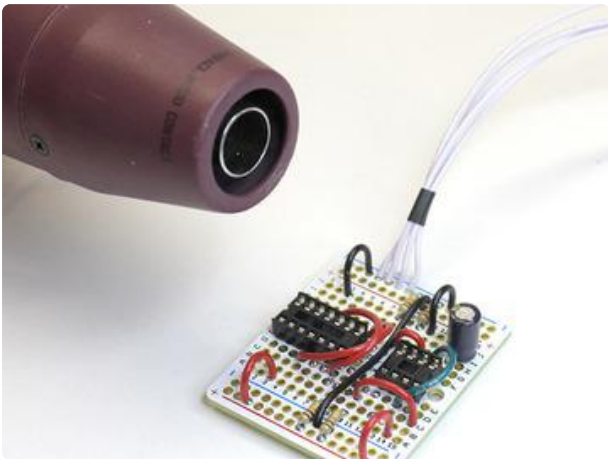

Now slide the heat-shrink back down the wires, about 3/4" from the board, and apply heat. Most people simply use a butane lighter for this, but if you have a heat gun that's even better.

The heat-shrink tube lets these wires rely on each other for support; they're less likely to break off the board when cramming this into the case later.

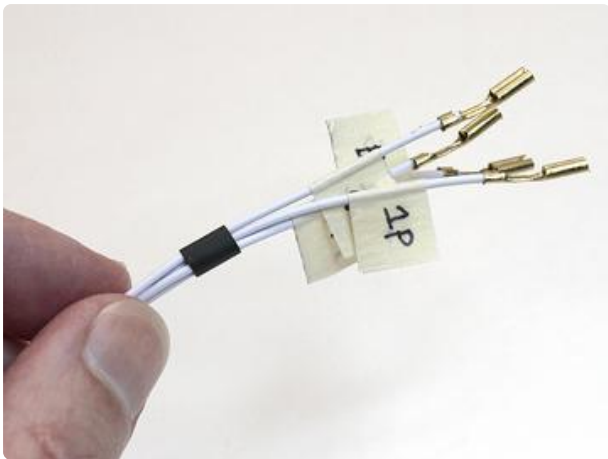

Now do a similar thing with the four labeled quick-connect wires. Slide a piece of heat-shrink as far along the wires as it will go.

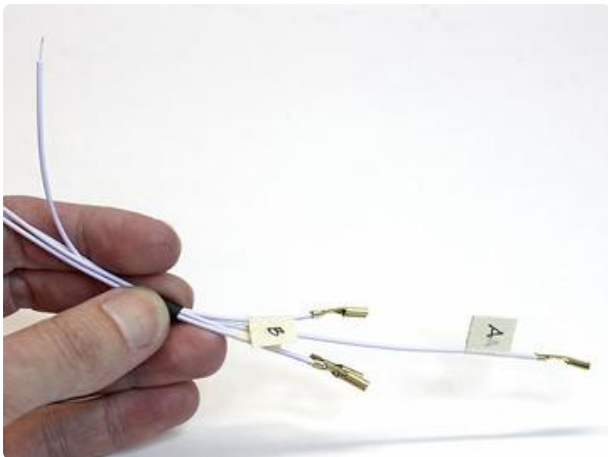

Now slide just one wire part way out, so we can tell it apart from the others at the bare end. Here we pulled the A wire and can identify its tail from the others.

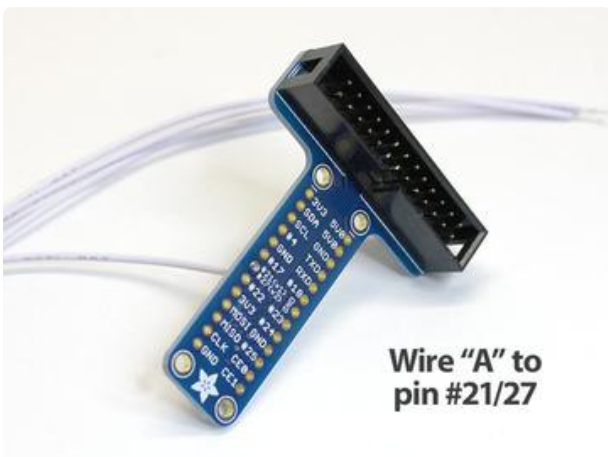

Using the schematic at the top of this page for reference, solder the other end of the wire to the appropriate point on the T-Cobbler. Wire A goes to Pin #21/27

The wires should enter from below the Cobbler and are soldered on the top. This is the opposite of the Perma Proto circuit. Clip away any extra protruding wire after soldering.

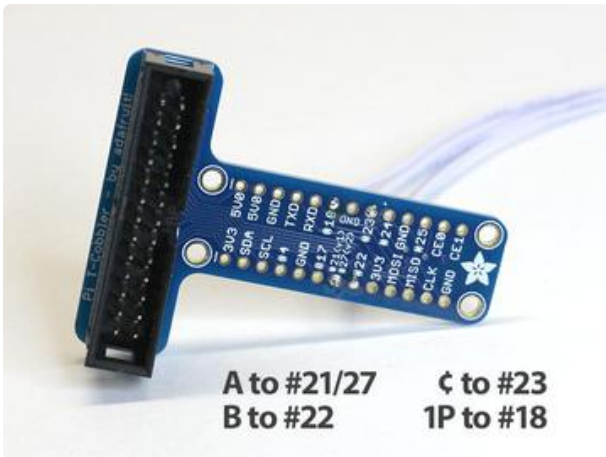

Repeat with the other three wires, one at a time so you don't get them mixed up. Slide one wire part way out of the heat-shrink, grab the "tail" and solder in to the correct spot:

- A to #21/27
- B to #22
- C to #23
- 1P to #18

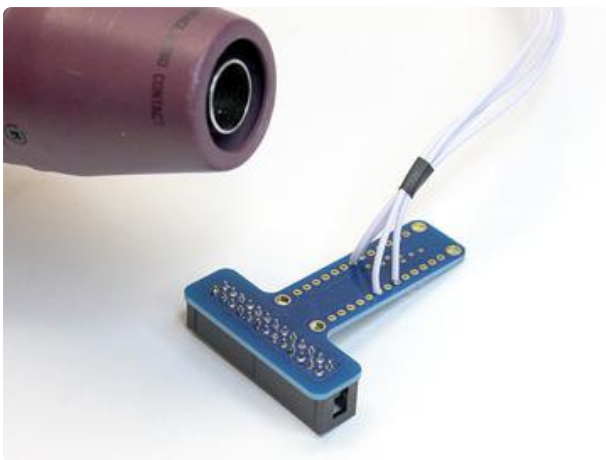

Slide the heat-shrink tube down close to the Cobbler and apply heat.

It's so tidy!

Joystick Wires

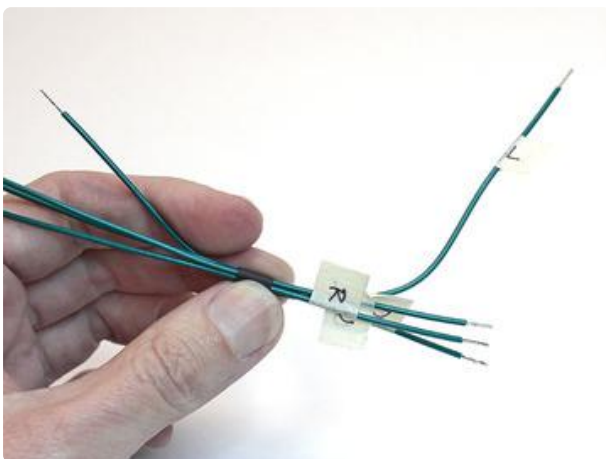

It's a very similar game with the U/D/L/R wires: squeeze them all through a piece of heat-shrink tube, then pull out one wire at a time, soldering the tail (unlabeled) end to the appropriate locations on the Cobbler...

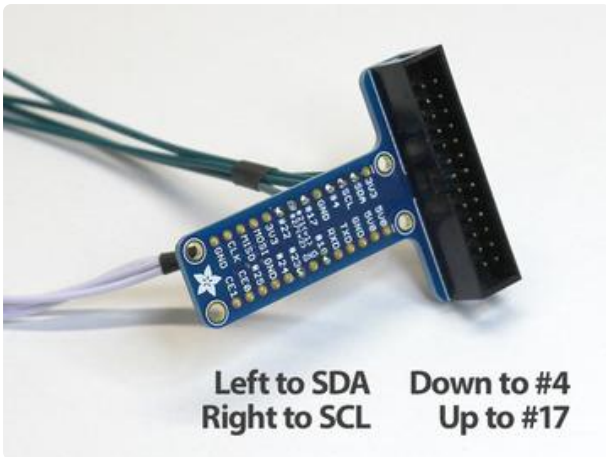

L to SDA
 R to SCL
 D to #4
 U to #17

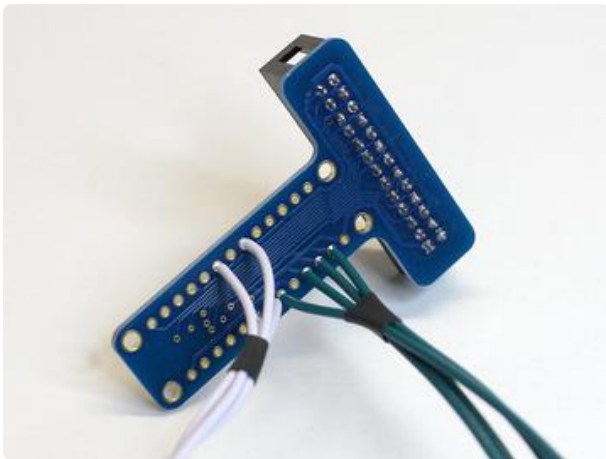

Scoot the heat-shrink down close to the
 Cobbler and...you know the drill.

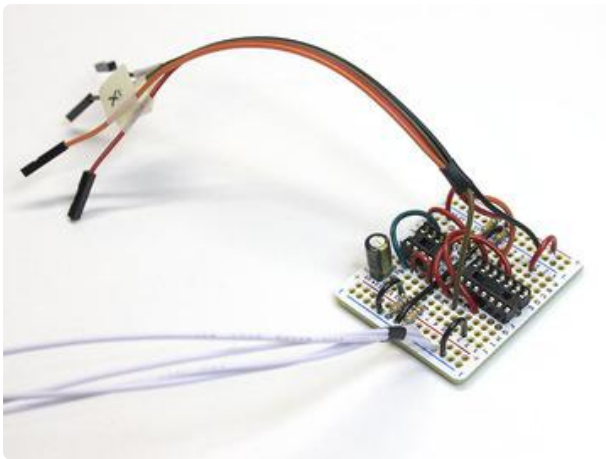

Returning to the Perma-Proto for a
 moment...

Solder the four ribbon jumpers (+, X, Y, -)
 to the appropriate points on the Perma-
 Proto circuit, using the diagram at the top
 of this page for reference.

Since these wires are conjoined, they
 don't really need heat-shrink tube, but
 you can add a piece if it makes you feel
 better. Remember to slide this on before
 any soldering.

Power Wires

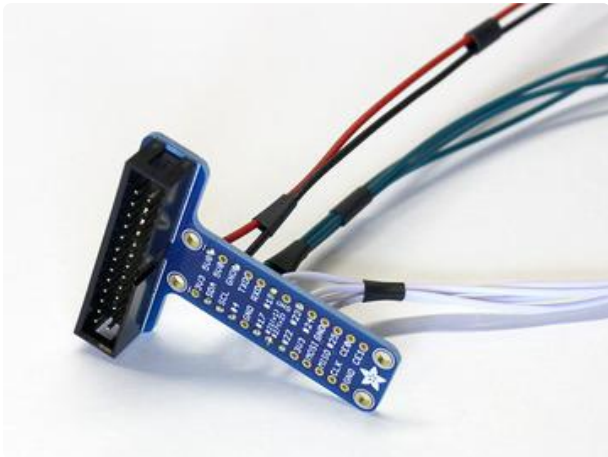

Add plain wires to the +5V and GND pins on the Cobbler (color-coded if you have them...if not, label these wires to avoid trouble).

These wires get two heat-shrink bits.

Notice also a second piece of heat-shrink has been added to the green joystick wires. But don't shrink any of these yet.

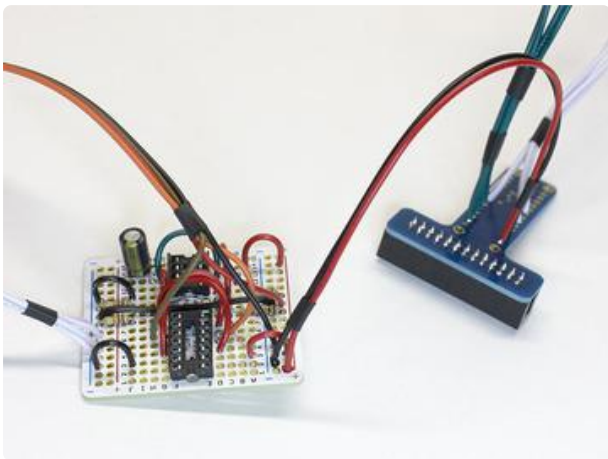

Solder the other end of the power wires to the appropriate positions on the Perma-Proto board, then heat-shrink the tubes near the ends.

The two boards are now permanently connected and will conspire to make your life miserable.

Before making further connections between these two boards or any other parts, plan it out first...make sure you're not tying knots. As you proceed, turn the boards different ways as necessary to find a smooth path between the two.

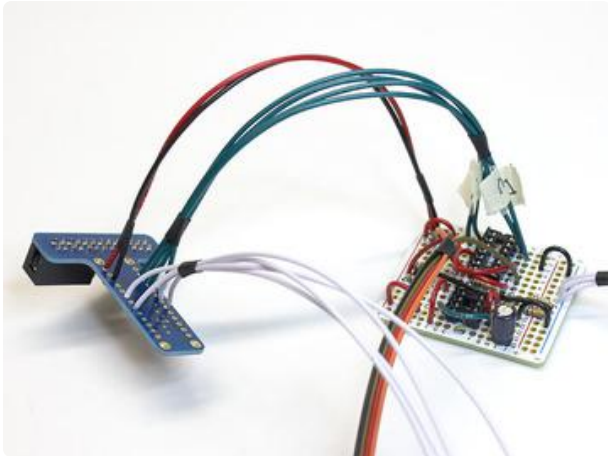

The four direction wires (U, D, L, R) can now be soldered to the appropriate positions on the Perma-Proto board. Refer to the schematic.

Now you can shrink that second piece of tube on the joystick wires.

See how the two wire bundles aren't fighting each other or making pretzels? That kind of order is what you're aiming for.

Audio Wires

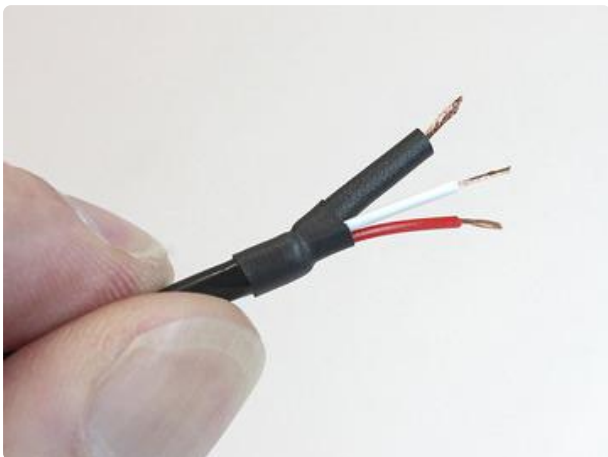

That bare copper wire on the audio cable is a problem...it connects to a ground point right next to a +5V line. We must insulate!

Slide a piece of heat-shrink tube a few inches down the cable (surrounding the whole thing, not just the copper wire).

Slide a second piece of heat-shrink tube over just the copper wire (cut one a little longer from your remaining unused tube) and heat it up. This covers most of the wire, but there's still a tiny gap.

Slide the first piece back up so it covers the gap, apply heat.

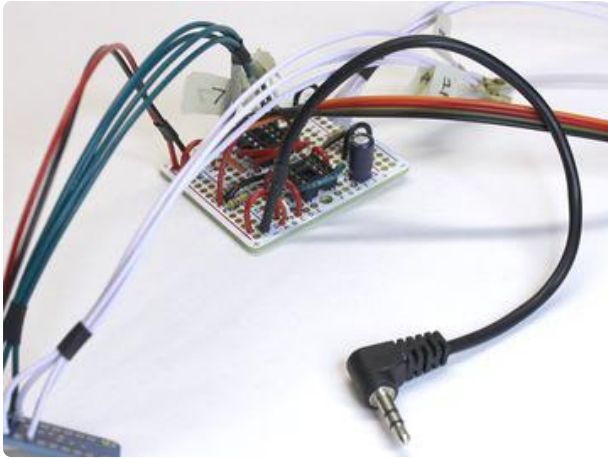

Solder the three wires to the proscribed locations on the Perma-Proto circuit.

If you have a headphone cable with red and black and copper wires, treat the black wire as if it were the white wire. The 'raw' copper wire is always the ground wire!

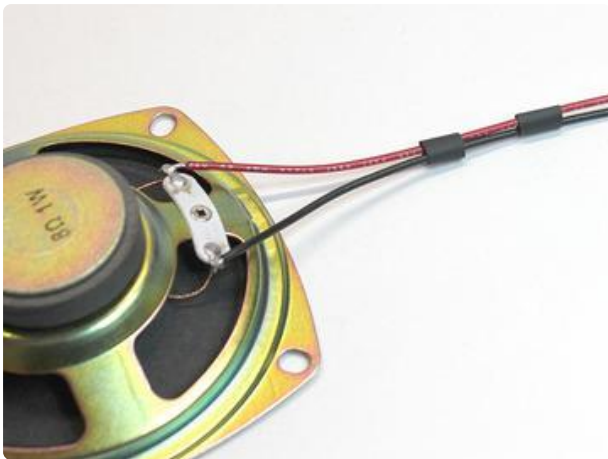

Solder two plain wires to the connection points on the speaker.

You can color-code these if you like, but it's really not vital.

Then add two pieces of heat-shrink tube. Don't shrink yet!

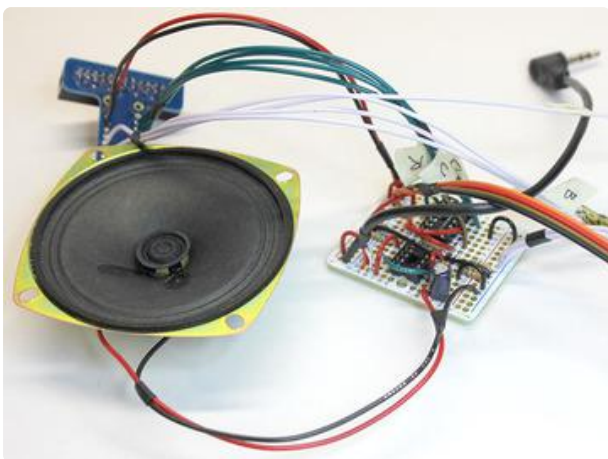

Solder the opposite end of the wires to the corresponding points on the amplifier circuit, then shrink the tubing near each end.

Soldering's done!

The chips can now be inserted in the sockets. They need to be installed “back to back” — pin 1 (the end of the chip with the little bite missing) is in a different orientation for each:

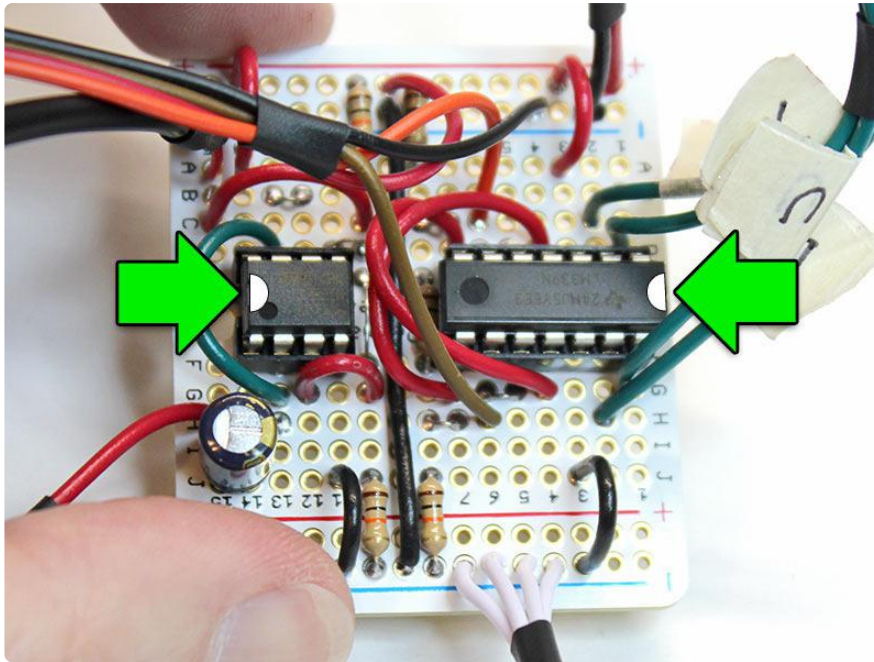

Gen 1 & 2 Continued...

Other than the electronics, the first- and second-generation kit assembly is the same...

PiTFT Assembly & Test

These directions are for the first- and second-generation Cupcade kits. Gen 3 assembly is slightly different, described in its own section. These directions are for the original “Gen 1” Cupcade kit. Later generations of the kit are described in their own sections. You probably don't have one of these unless you have a very old kit!

Given this project's complexity, we'll be testing and re-testing the system to validate our progress. Confirm your system passes each test before advancing to the next. Mis-steps are very time-consuming!

We'll build and test the Raspberry Pi and PiTFT display with a USB keyboard plugged in. The arcade controls and cabinet will come later.

Solder Time!

It's time to build your kit! Heat up your soldering iron and lets get started!

The PiTFT may come pre-assembled. If so you can skip the soldering part here



The tall female (socket) and shorter male (pin) headers will be installed in the positions shown. The female socket goes on the long edge of the PiTFT board, male on the short edge (labeled “Connector on reverse!” on the silkscreen side of the board).

Note the position of the key (notch) on the male header, facing the center (not outside edge) of the board. Vitally important!

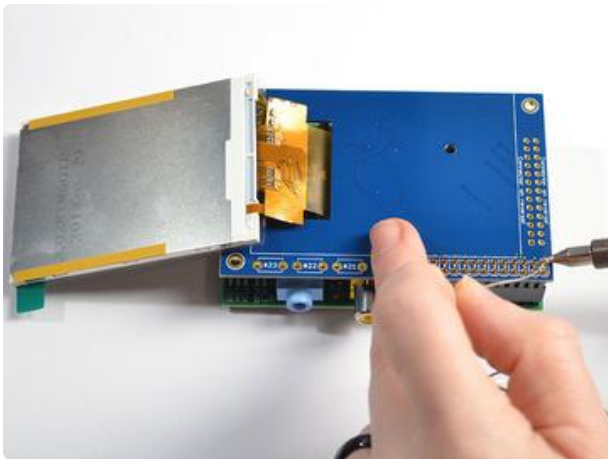

When soldering the female header, the Raspberry Pi can be used as a “stand” to hold the header and board in alignment. For the male header, you’ll probably need to hold it in place temporarily with masking tape.



After soldering, peel the backing off the tape strips and position the screen on the board, leaving a little space between the header and the metal edge of the screen.



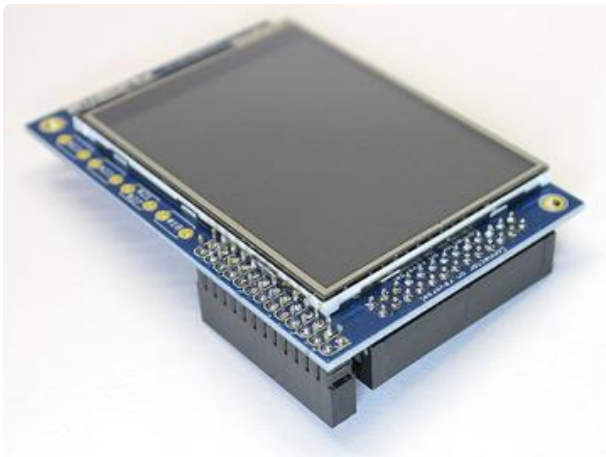

This is what good soldering looks like. The solder flows smoothly between the pins and the pads on the board, no blobs, bridges or gaps. [The Adafruit Guide to Excellent Soldering \(https://adafru.it/cA6\)](https://adafru.it/cA6) has pointers for novices.

Once you're satisfied with the soldering and screen alignment, the protective film can be peeled from the display. This is not a screen protector like on your phone!



Install the PiTFT on the Raspberry Pi, making sure the header pins are aligned.

Connect a USB keyboard (not shown here) and plug the Raspberry Pi into a power supply.

Within about 10 seconds of connecting power, you should see the display come to life, with geeky Linux boot messages scrolling by, and eventually a game selection menu (list will be empty if no games have been loaded on the card yet).

If there's no response...

If nothing happens for 30 seconds or longer...either a black or white screen... disconnect power, remove the PiTFT board, plug the Raspberry Pi into a regular monitor and power up again.

If RetroPie starts normally on the HDMI monitor: Pi and SD card are fine, PiTFT is not. Examine your soldering closely, looking for any bridges or solder balls. Make sure the headers on the PiTFT and Raspberry Pi board are correctly aligned. Make sure the metal edge of the LCD is not contacting any of the header pins.

If it does not boot on either the PiTFT or monitor: possibly something wrong with the SD card; perhaps the operating system was not properly installed or something is

amiss with the PiTFT assembly. Is it plugged in right? (Sometimes the header pins are off-by-one and it doesn't work.)

Press F4 to exit to a command line prompt, then type:

```
sudo shutdown -h now
```

Wait about 20 seconds for this operation to run before disconnecting power.

Do not proceed until you have a working system, including the PiTFT.

Now a Second Test...

With the system powered off, remove the PiTFT board from the Raspberry Pi. Take the ribbon cable included with your kit...



The header on the PiTFT is “keyed” so that pin 1 (the white wire) is always on the correct side. However, there’s two ends to the cable. Plug in the end that places the cable running behind the PiTFT board, not out in the open.

Careful now...the header on the Raspberry Pi board is not keyed! Pin 1 (white wire) should be near the edge of the board with the SD socket. Make sure the pins are aligned, not off by one. This end of the cable should point out in the open, not overlapping the Pi.



Turn the screen over and connect a USB keyboard and power. After a few seconds you should see the same bootup sequence as before.

If the PiTFT worked when connected directly to the Pi but does not work with the ribbon cable:

- Double-check the cable orientation and alignment, make sure nothing's turned around or off by one.
- Shut the system down, remove the ribbon cable and re-connect the display directly atop the Pi. If it won't boot now (but did before), something's gone wrong with the SD card. Otherwise...
- If everything checks out but it still won't boot with the ribbon cable connected, the cable may be defective. Visit the Adafruit Customer Support Forums, post a photo of your hardware and we'll look it over for any gremlins or will have a replacement sent.

Test ROM

If you have any ROM files loaded in the boot/advname/rom folder, you can select a game from the menu (using the arrow keys and enter) and see if it works. This is a good time to decide which games run well or not.

Press the ESC key to exit and return to the game menu.

This concludes the first phase of testing. Do a proper shutdown again (ESC from the game menu) and wait about 20 seconds before disconnecting power.

Do not continue to the next step until you have a working system.

Dry Run

These directions are for the Gen 1 and 2 Cupcade kits You probably don't have one of these unless you have a very old kit!



Re-install the ribbon cable between the Raspberry Pi and PiTFT, making sure the Pin 1 (white wire) is in the correct location.

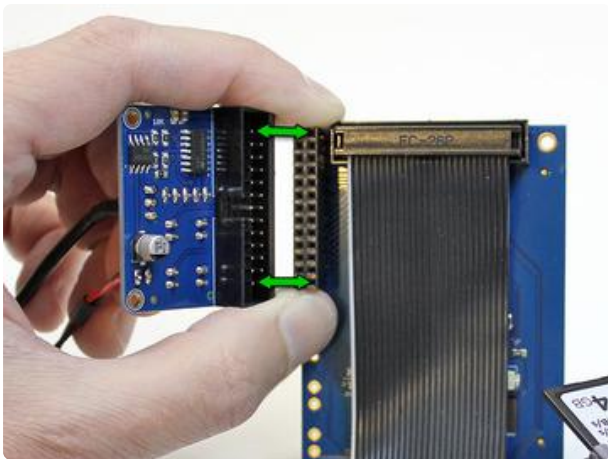

The Cupcade interface board now installs on the female header on the back of the PiTFT.

Be super careful to line up the pins! There's enough wiggle room either way for this to be offset by one pin. The Pi won't boot unless it's properly centered.

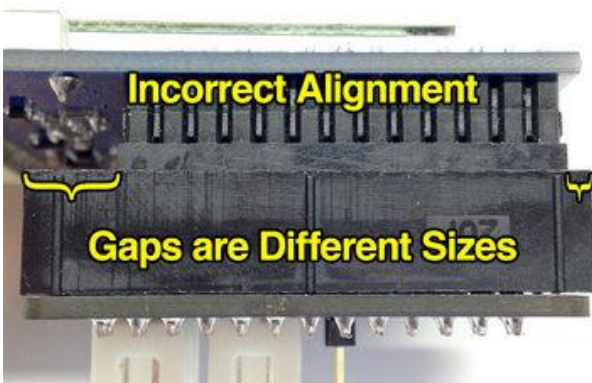
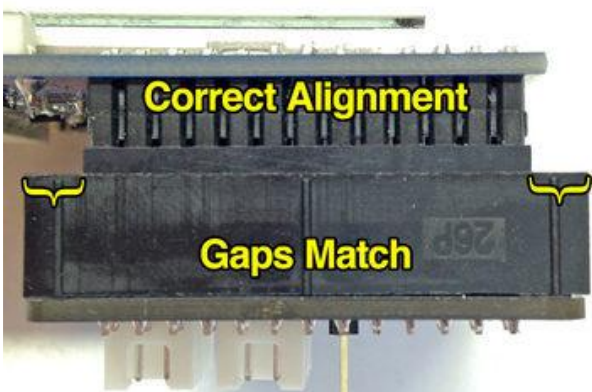

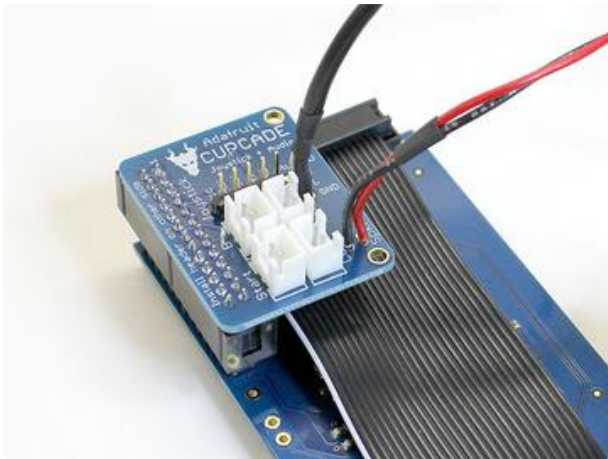

The board should be oriented to sit behind the PiTFT and ribbon cable, not hanging out over the side.

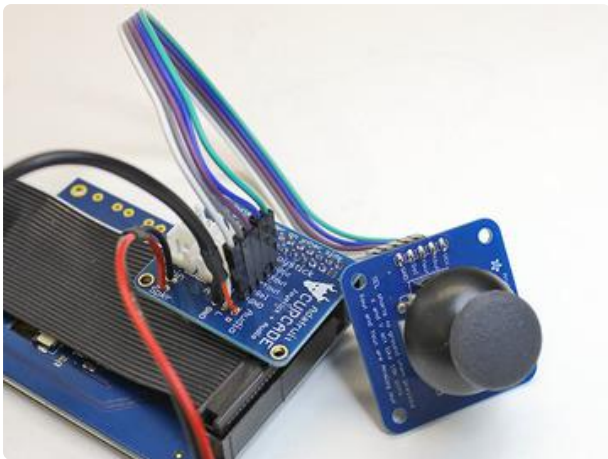

Connect the female jumper wires between the analog thumb joystick and the Cupcade board, making sure the same pins are connected at each end (e.g. GND to GND and so forth). Wire colors vary from batch to batch; yours might not match this photo, that's OK.

The Sel pin is not used. If your kit has only four wires in this bundle, just skip over that pin.

The joystick MUST be connected for the Cupcade to work.



Plug a quick-connect wire set into each of the four buttons.

There's no specific polarity to these... either wire can go to either pin.

The two red buttons will serve as the "A" and "B" action buttons. The two black buttons are for "Start" and "Select" (the latter is labeled "Coin" on the Cupcade PCB, as this button is typically used for MAME's insert-coin function).

Plug each quick-connect into the corresponding labeled jack on the Cupcade interface board.



Plug in the audio cable and you're almost ready to go...

Before connecting power, make sure no conductive parts are making accidental contact with each other:

- Quick connects or the nut on each button
- The metal frame of the speaker
- The back side of the Cupcade interface board
- USB and Ethernet jacks on the Raspberry Pi

You can tape pieces down to your desk if it helps.

Once everything's safely spaced apart, plug in the Pi. It should boot to the game menu.

If the Pi Does Not Boot

If you don't see the system starting the boot process within 10 seconds or so (watch the ACT LED on the board), disconnect power immediately.

Carefully unplug the Cupcade interface board from behind the PiTFT and try booting again. Does it work now? If so, the problem is usually with the new parts.

- Was the board properly aligned with the header on the PiTFT? It's easy to get this off by one.
- Are any of the button quick-connects making accidental contact with each other?
- Is the joystick connected? Cupcade won't boot without it.
- Are the four wires connected to the proper pins in the correct order on the joystick? Even a single mislaid wire here can prevent the Pi from booting!

- Examine the joystick closely, specifically the horizontal and vertical potentiometer dials on the sides. When you move the stick around, can you see both dials turning with it? If not, the joystick may be faulty.

If the Pi still refuses to boot when the board is connected, visit the [Adafruit Customer Support Forums \(https://adafru.it/cer\)](https://adafru.it/cer) for help. Post clear photos showing your wiring and soldering and we'll look it over for trouble spots and make recommendations.

If the Pi Boots Successfully

Rejoice! Test the game menu by moving the joystick around. If you have any ROMs loaded (see the “Installing ROMs” page) you can give 'em a whirl.

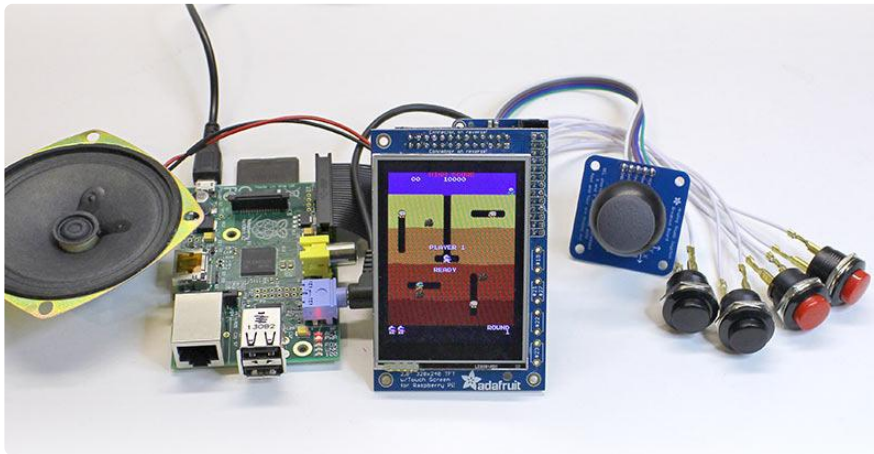

Some of the buttons/joystick work but not all!

Check if you have all the connections solid and going to the right location. The joystick socket connectors can slip off if yanked!

When You're Done Testing



If you have a game loaded, hold down both the Start and Select buttons to return to the main RetroPie screen.

Navigate to RetroPie's main menu and select the "Quit" option. In the resulting menu, select "Shutdown System."

Wait about 20 seconds for the system to complete this operation before disconnecting power.

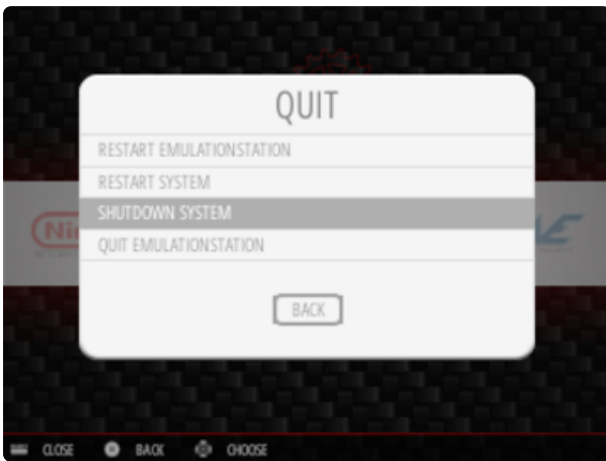

ALWAYS turn off Cupcade using the Shutdown System menu option. Just pulling the plug runs the risk of corrupting the SD card contents, and you'd have to start over.

Do not continue until the system is tested and the controls are known working.

Cabinet Part 1

These directions are for the Gen 1 and 2 Cupcade kits. You probably don't have one of these unless you have a very old kit!

Fitting all the electronics inside the case is the most challenging part of this project. Our advice:

- Don't force anything. If something refuses to fit, it might simply be in the wrong position.

- You might need to temporarily disconnect some parts (like the buttons or joystick) to re-route the wires in a less tangled manner. Sometimes repeatedly. If the wiring seems to magically change from one of our photos to the next, that's exactly what happened.
- Take your time. If things aren't cooperating and you get frustrated, walk away, try again after a break.

Why not just design a case that's easier to assemble?

It makes sense once it's all together. There are just a few visible screws on the sides, and the area around the controls is perfectly smooth, with no screw heads scratching at your fingers. An easier case would have a lot more visible fasteners, some of them in uncomfortable positions!



With the Pi powered off, disconnect all of the separable parts:

- Raspberry Pi board
- PiTFT display
- Ribbon cable
- Joystick
- Buttons (4)

The Cupcade board, speaker and audio cable should all stay joined as a single thing; don't clip any wires!

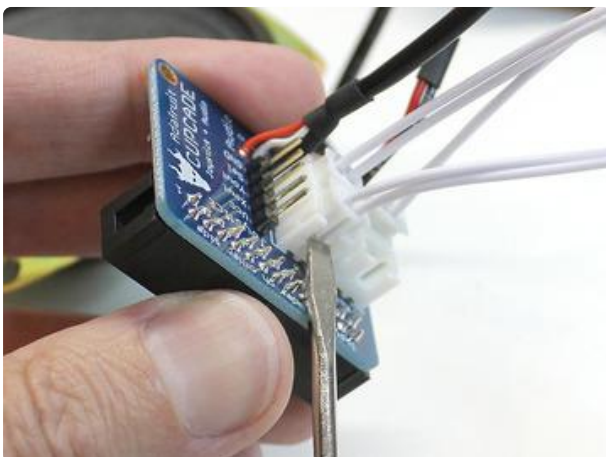

A small screwdriver is sometimes helpful when unplugging the buttons from the JST sockets. A little twist is usually sufficient...use common sense and be gentle.



Remove all of the nuts and washers from the four buttons. You can leave the quick-connect wires attached.

Lighting and staging photos is time-consuming! A handful of images from different Cupcade revisions are still shown here. Don't panic if your Cupcade looks a little different...it should all work the same.

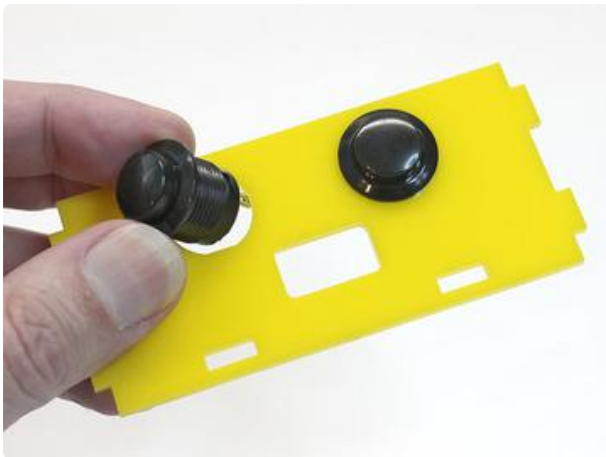

Let's do the credit and start buttons first. We chose the black buttons for this.

Look for the acrylic piece that resembles a startled face. Slide a button (with attached quick-connect) through each "eye," then add a washer and nut from behind.

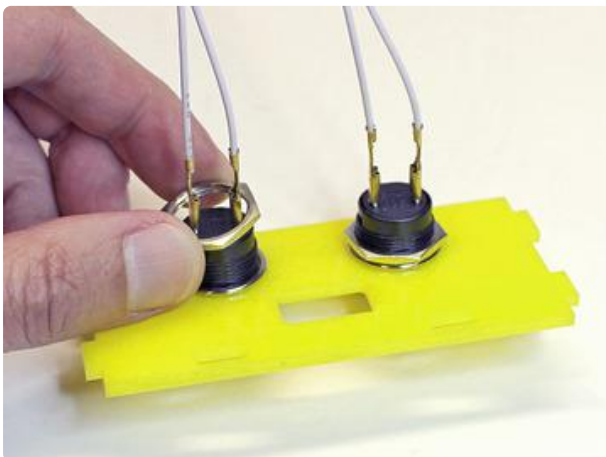

Tighten these with finger pressure only. Don't use tools or you'll crack the plastic!

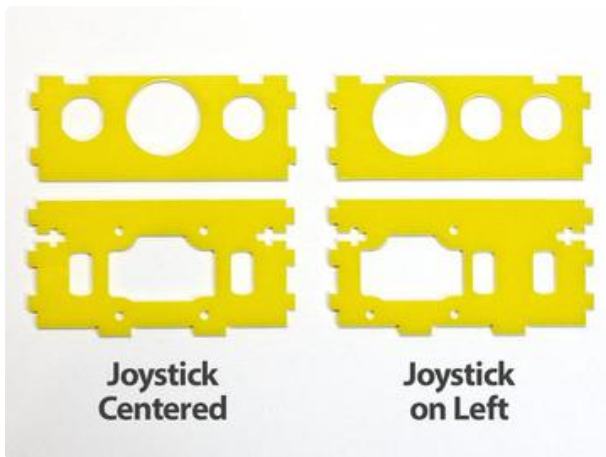

Early on, we mentioned a choice to be made: centered or off-center joystick? Now is your last chance to decide.

There are two acrylic parts required for the controls. Select the pair that matches your desired control layout. The other two can be stored somewhere in case you want to switch it out later.

If you want the joystick on the right, just flip these pieces over.



Two red buttons are installed on the chosen control cutout. Because this part is thin in one spot, it must be done with care.

When tightening each nut, hold the acrylic piece close to the corresponding button, not at the far end.

(This is one of those beta photos. Yours will have the quick-connects attached.)



Taa-daah!

Notice the piece with the red buttons has two “bites” along the top edge. If they’re at the bottom, and if you’re using an off-center joystick layout, undo the buttons and flip this piece over. With a centered layout, just turn it around.



Masking tape. You'll need it. Doesn't matter if it's the blue or tan type, but it does need to be masking tape. It has a relatively weak grip and doesn't leave residue behind.

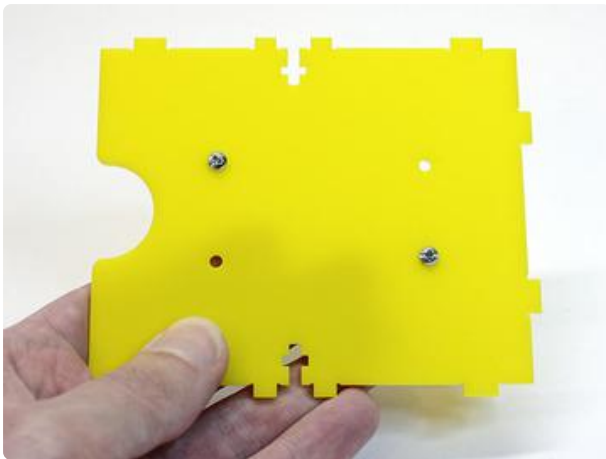

Locate the acrylic bottom piece and insert two #4-40 1/2" screws in the positions shown.

There are four holes, but only two screws. These align with mounting holes on the Raspberry Pi board. Most of the case pieces are symmetrical so they can be flipped either way...makes things a little easier.

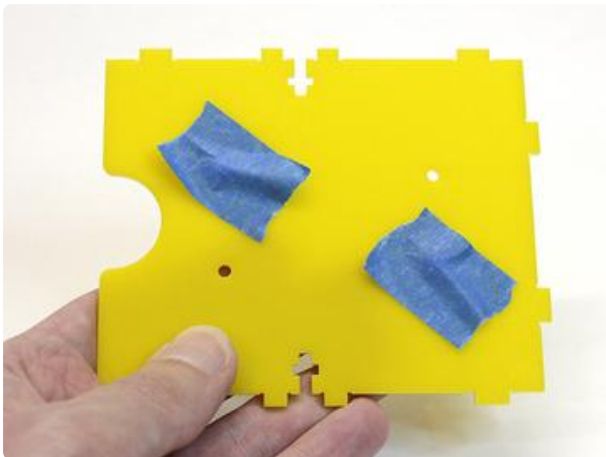

Add a piece of masking tape over each screw head to keep them from falling out.



Set the piece down on your work surface with the screws pointing up, then add a nylon spacer over each screw.



Align the mounting holes on the Raspberry Pi over these two screws.

The SD card slot should be facing the edge with the “bite.” If you get this backwards, there will be pain and anguish later as everything has to be dismantled and turned around.



Add a nut on each screw and give them just a few easy turns.

Once the board is held in place, remove the tape and give each screw an extra half turn or so with a screwdriver. Don't go overboard, you don't want to crack the plastic, just make sure the board is secure and the screws aren't rattling.

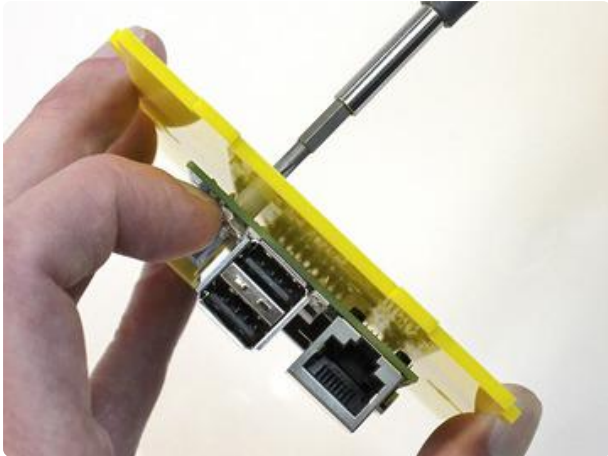

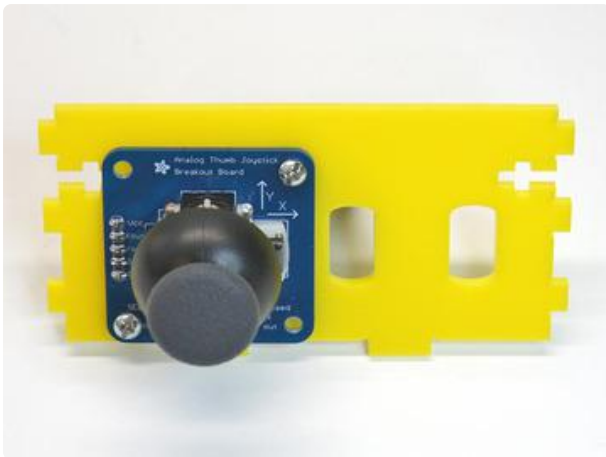

Install the joystick on its support piece, whichever one you selected (centered or off-center). Two screws at opposite corners are sufficient.

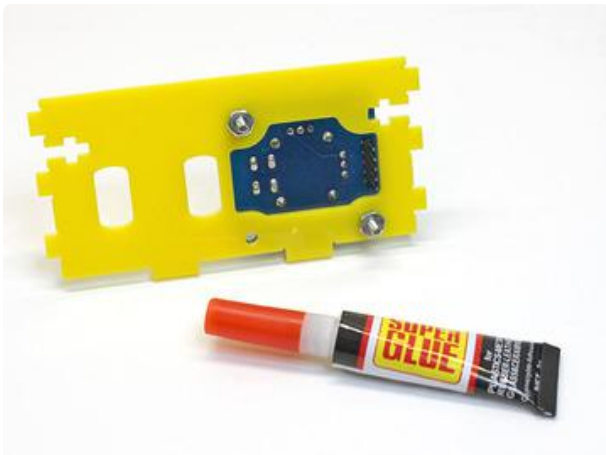

Note the orientation of the joystick and support piece here. With the joystick's silkscreen labels upright for reading, the support's two protruding tabs should be at the bottom of the piece. This is one of the few non-symmetrical parts, so make sure you get the orientation right. It's very frustrating to do over.

There's a little wiggle room between the parts. If using an off-center joystick (as shown here), scoot the joystick that tiny extra bit away from the buttons before tightening the screws. This keeps the joystick from bumping up against the buttons during play.

Optional: a dab of thread lock, super glue or hot-melt adhesive on each nut helps keep these screws from loosening with heavy gameplay.



Install the PiTFT on its backing piece using three tiny #2-56 screws and matching nuts.

This is another non-symmetrical part with a specific orientation. The screw holes should make it evident which way this goes.



Install the speaker grille using two screws at the top.

The bottom holes do not receive screws (yet). However, before tightening the top nuts, make sure the bottom screw holes in the speaker and grille are aligned; there's a bit of play.

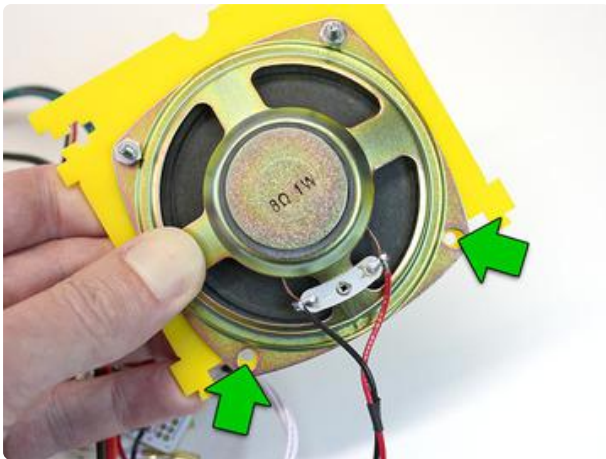

Awesome. Now the puzzle box stage begins. This is a good time for a cookie break.

Cabinet Part 2

These directions are for the Gen 1 and 2 Cupcade kits. You probably don't have one of these unless you have a very old kit!

Now we'll join the speaker and screen parts...



The screen fits into two slots at the bottom of the speaker grille.

Depending which way you've installed the screen — horizontal or vertical — one "T-slot" will be located at either the left or the right side.

For a VERTICAL SCREEN: the T-slot should be on the LEFT. If it's on the right, you've got the screen piece upside-down.

For a HORIZONTAL SCREEN: the T-slot should be on the RIGHT. If it's on the left, the screen piece is upside-down.



Feed a nut into the cross part of the "T," holding it in place between thumb and forefinger.

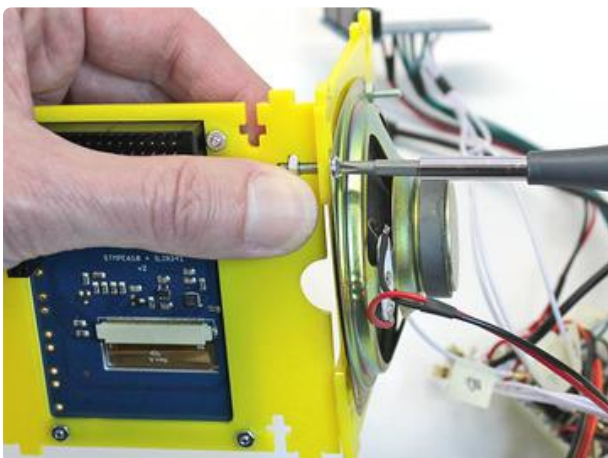

Bring the two pieces together and add a #4-40 1/2" screw. This will pass through the speaker frame, the plastic grille piece and into the nut.

Only one of the two speaker/screw holes is used, depending which way the screen is oriented.

Joystick and Buttons

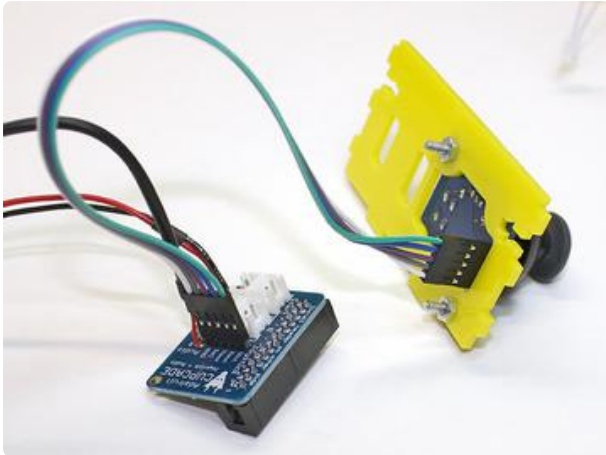

Connect the female jumper wires between the joystick and Cupcade board, making sure you get the same sequence (e.g. GND to GND and so forth). If you get these out of sequence, the Pi might not boot!

If your wire bundle has only four wires, you can skip over the Sel pin; it's not being used here.

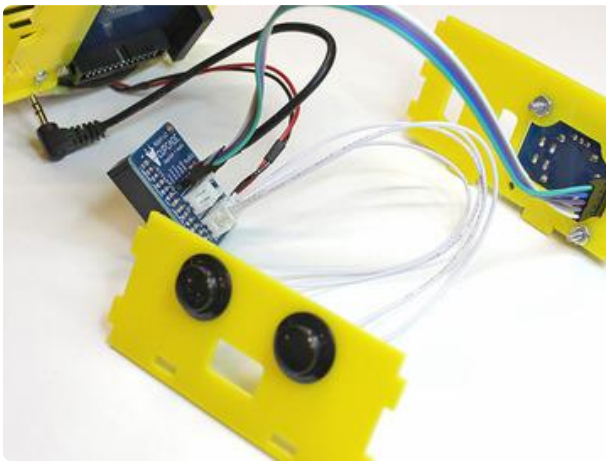

Plug the 1P (left) and 1P (right) buttons into the corresponding sockets on the Cupcade board.

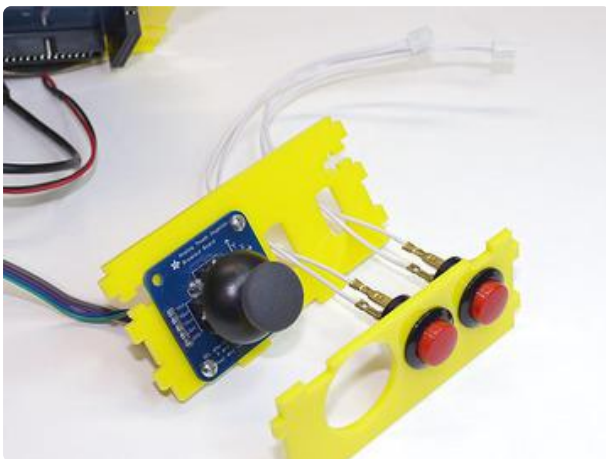

The A and B buttons require an extra step...

First, feed the quick-connect wires through the corresponding slots on the joystick plate.

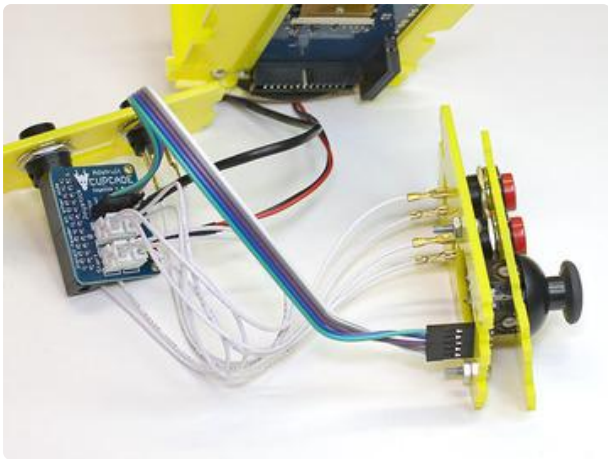

Then plug these into the corresponding sockets on the Cupcade board.

Loosely fit the button support over the joystick support. It's okay if this flops around for the time being...everything will be held in place later.

Look over your wiring before proceeding. Are the wires reasonably well organized, or are they twisted around each other like weeds? If necessary, unplug one wire at a time, untangle it from its neighbors and plug it back into the correct location. This isn't just a persnickety thing, it's actually important for fitting everything in the case later!

Screen and Audio



Plug the audio cable into the headphone jack and the ribbon cable to the GPIO header, making sure pin 1 (the white wire) is in the correct place.

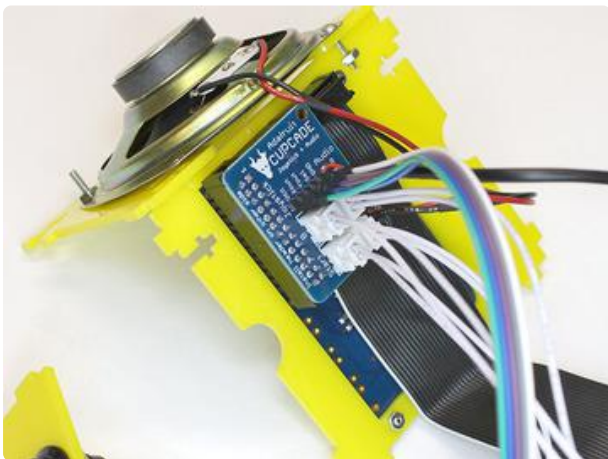

The Cupcade board plugs into the back of the PiTFT as it was during our dry run.

Be super extra careful to get the headers correctly aligned. There's enough wiggle room either direction for it to go one pin out of alignment!

You can do another dry run at this point if you like...it's a really good idea. Then shutdown the system (hold credit + start buttons while the game menu is showing).

Cabinet Part 3

These directions are for the Gen 1 and 2 Cupcade kits. You probably don't have one of these unless you have a very old kit!

The case uses the “T-slot” assembly technique, with #4-40 screws and nuts. You saw one of these when joining the screen and speaker pieces.

Unlike that first slot, the remaining T-slots will be too deeply recessed to reach with fingers. Instead, we'll use masking tape to temporarily hold each nut in place, then remove it later.

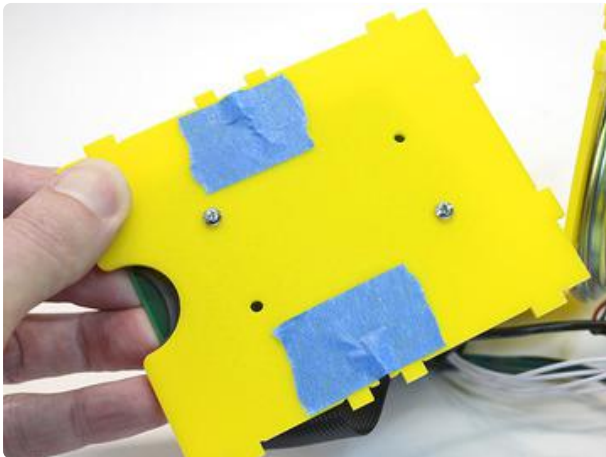

Put a piece of masking tape over each of the two T-slots on the underside of the base piece (where the Raspberry Pi is installed).

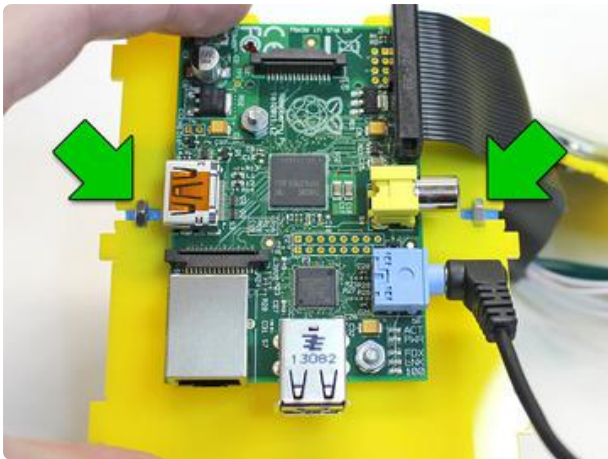

Then, from the top side, press a nut into the cross part of each “T.” Give it a pinch from both sides, so the tape gets a good hold on the nut.

Try to get the nuts roughly centered-ish in the slots.

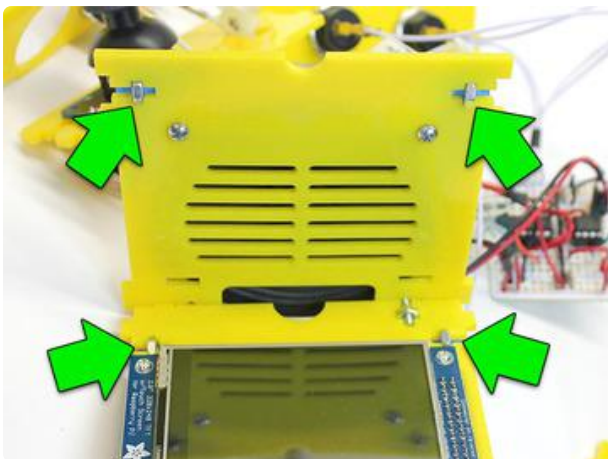

Add tape behind the two T-slots at the top of the speaker grille, then press nuts into place.

Do the same for the two slots near the top of the screen.



And once more for the joystick support piece.

There should be 8 nuts & tape bits at this point.

Okay, the Tricky Part



Set one of the large side pieces flat on your work surface. Either one is fine... we're using the right side here.

Hey! That wasn't so hard. Wait for it...

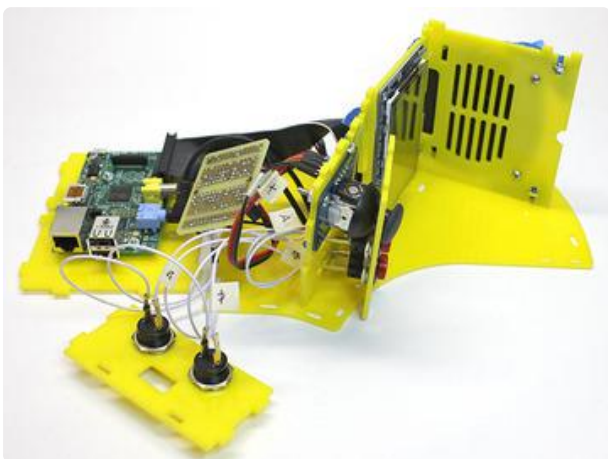

Take the jumble of parts and try to (roughly) align the tabs on the speaker grille, screen and joystick supports with the corresponding holes in the side piece. They probably won't stay in those holes for very long, but at least you'll know where they belong.

Start to place other elements vaguely in position: Pi near the bottom, buttons near the front.

If you find your wires getting tangly again, it's okay to disconnect and re-route them.

And so begins the interpretive dance called Sealing Up the Cupcade Case...

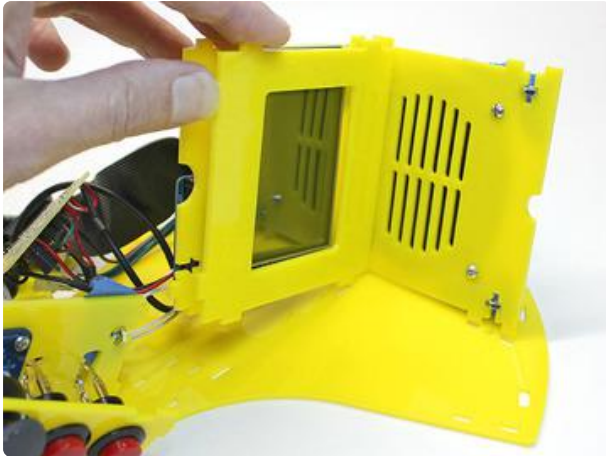

Pivot the screen support piece up slightly, fit the screen bezel into the slots on the speaker grille, and lower it all back into place.

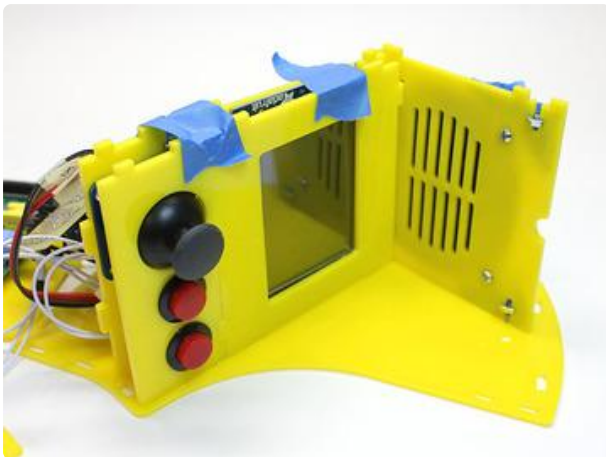

Fit the joystick and button supports into their own slots as you're working on this section. Use masking tape to hold these four pieces in alignment.

Notches along the top edge of the button support should align with tabs on the screen bezel. If not, your button piece was assembled upside-down. Remove the quick-connects, unscrew the buttons, turn the piece over and reassemble.

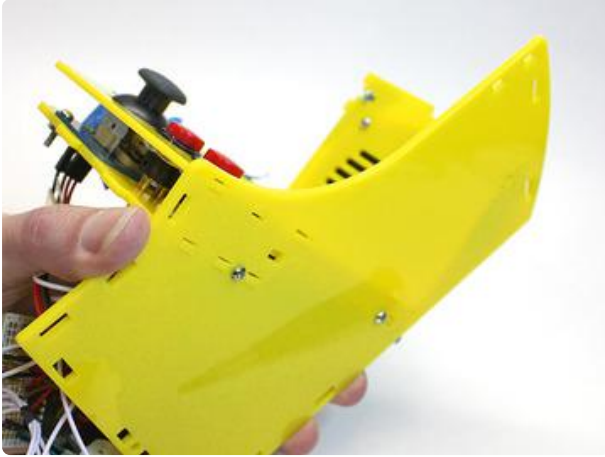

The trick now is to pick the whole thing up and feed these two screws through their corresponding holes in the side.

The screws don't need to be tight...in fact a little "give" is helpful at this stage. They just need to catch the nuts that are taped in place.

Some of the acrylic parts will fight a bit and not fit into their slots. Poke a small screwdriver through the hole and try to nudge these parts the right way.

If this is a dexterity challenge or you have smaller hands: rather than installing screws from below, remove the masking tape from the prior step and try fitting the side into place from above. Once the screws catch, you can turn it over and proceed through the same steps (just reversing right and left). Another approach is to scoot the whole assemblage off the edge of the table just enough to reach the screw holes from below (one at a time).

A third screw installs from the side at the top of the speaker grille.

A fourth screw holds the Raspberry Pi base. You'll need to stand this base piece up and fit it into the slots at the bottom edge of the side piece.

You can now remove the tape from a couple steps prior. Keep the other tape (holding nuts) in place for now.

The plastic piece holding the credit and start buttons should be hanging out the front of the case at this point. If not, move it there. It does not need to be fit into the notches yet, we'll do that later.

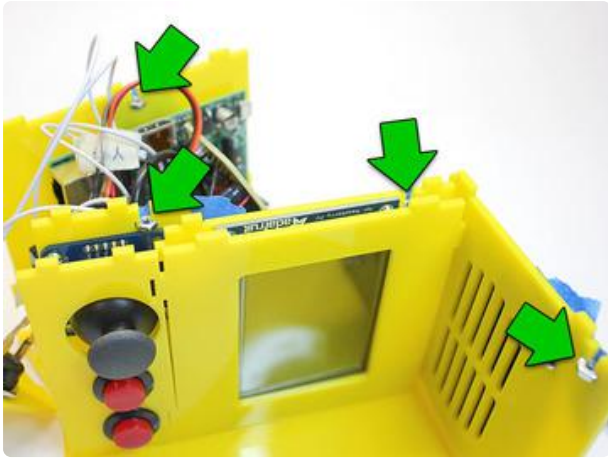

Now to repeat these four fasteners on the opposite side.

Make sure all four nuts are still held in with tape. If any have fallen out, press them back into place.

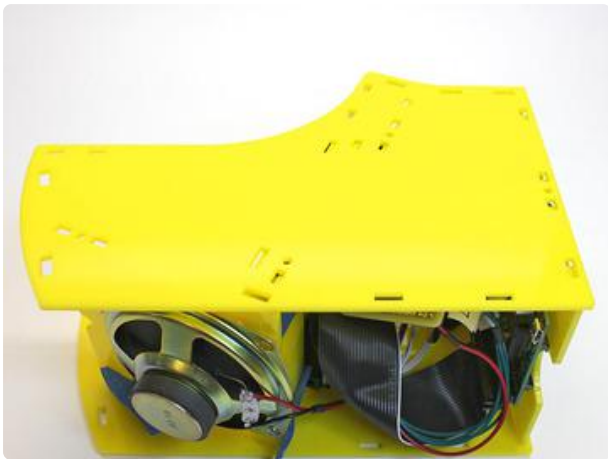

Now set the other side piece on top, roughly in position. I can guarantee the tabs won't all fit. That's okay, we'll align things one at a time...



Start with the base piece; this has the fewest interferences.

Get the tabs and hole aligned for this one part, then insert a screw. Do not crank it down...a loose fit is fine, just so it has a good hold on the screw.

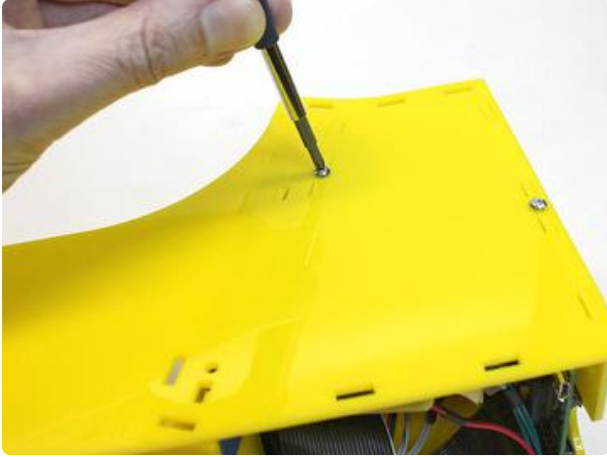

Work your way from bottom to top, aligning the tabs closest to each hole and then inserting a screw.

You may need to nudge each piece into position using the tip of the screwdriver through the slots, or with a finger from behind (when it can fit).

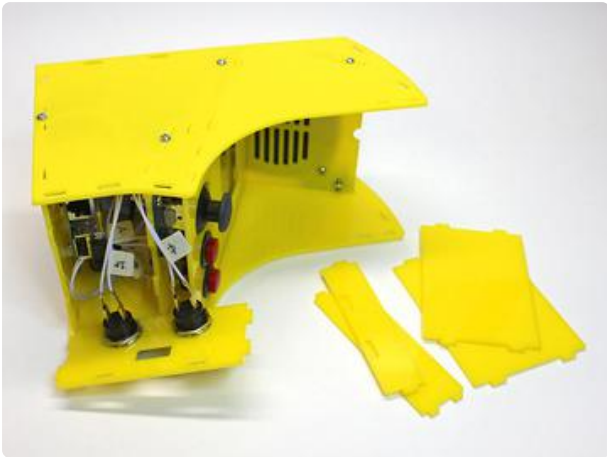

All four screws in place. Victory!

You can now remove the tape that was holding the nuts in place. Some of these will be deeply recessed; you might need tweezers to reach them. If you can't reach them, just leave them be...nobody will see them and they don't interfere with the system.

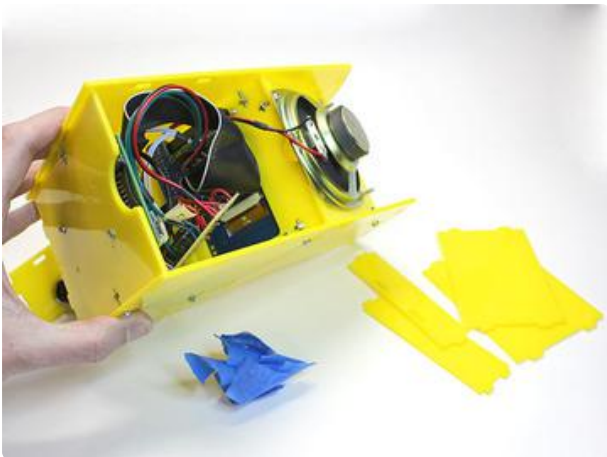

Now gather up the other four case parts...

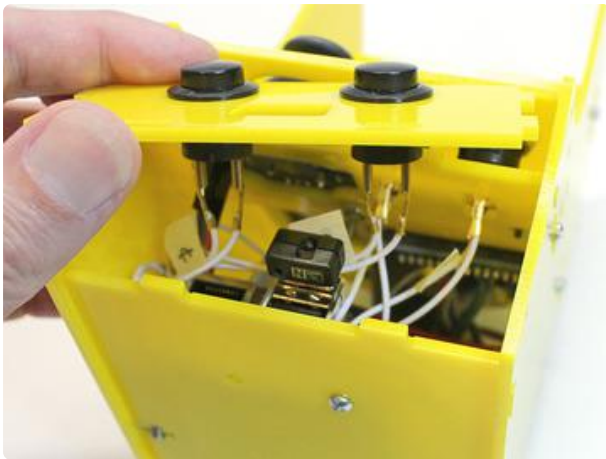

Friendly reminder: this is your last chance to add a USB mini WiFi adapter if you want! Plug it into the top USB slot. Leave the bottom slot open for a keyboard.

The case blocks access to the Ethernet port; WiFi is the only networking option.

Without WiFi, you can still load games into the system by inserting the SD card into a USB reader on your computer and moving ROM files to the `/boot/advnme/rom` folder.

Cabinet Part 4

These directions are for the Gen 1 and 2 Cupcade kits. You probably don't have one of these unless you have a very old kit!

To fit the remaining pieces, it's necessary to ease up on some of the case screws...but only slightly, and one at a time.

If unscrewed too far, the nuts can fall off inside the case. Then you'll have to dismantle the case and go back several steps to rebuild everything. That's no fun, so be careful!

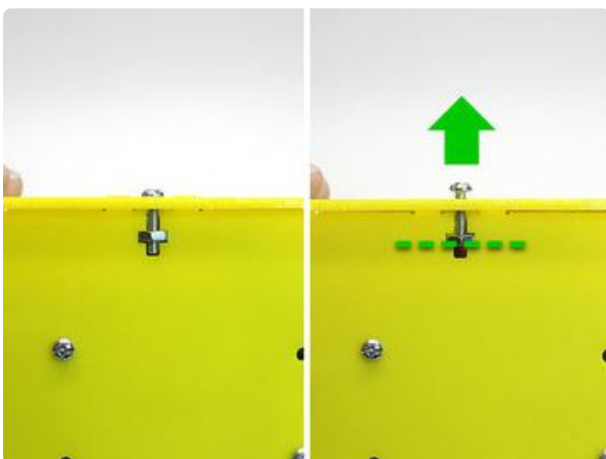

Start by loosening one of the screws on the base piece — either side, doesn't matter.

The tip of the screw should be flush with the face of the nut.

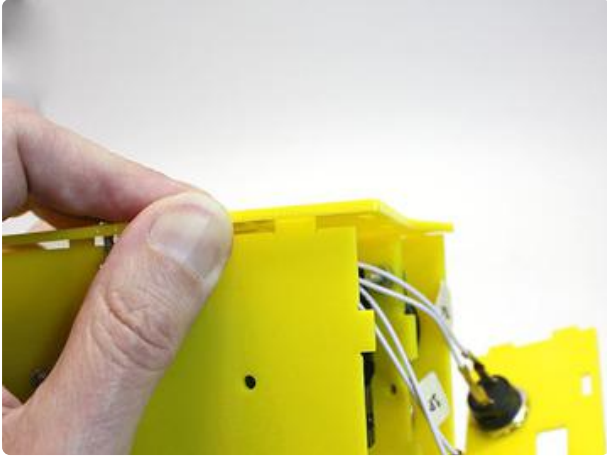

You should now be able to lift this edge of the case just a little.

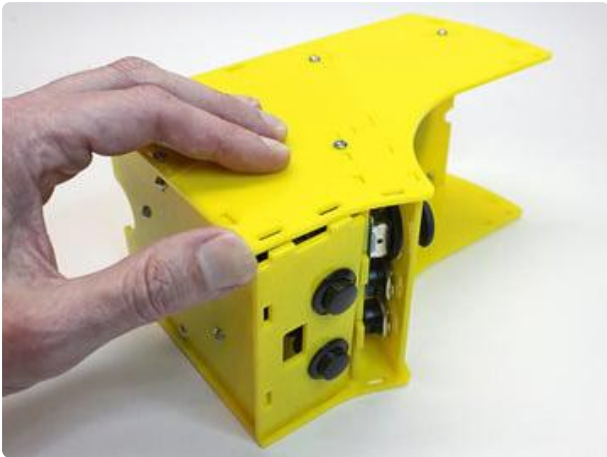

Stuff the credit/start button wires inside, then slot this piece into the holes on the “table” side of the case. Pivot it upright... tabs on the base should fit into holes on the front...and finally pop the last two tabs into the “loose” side.

If you need a little extra working room, you can loosen the same screw on the opposite side, or the next screw up this side of the case...but don't take it as far, maybe unscrew half as much, or everything may come apart.

Once the button piece is in place, tighten the bottom side screw and loosen the next screw up this side...the one nearest the joystick. Loosen it a similar amount...screw tip flush with the nut face...no further!

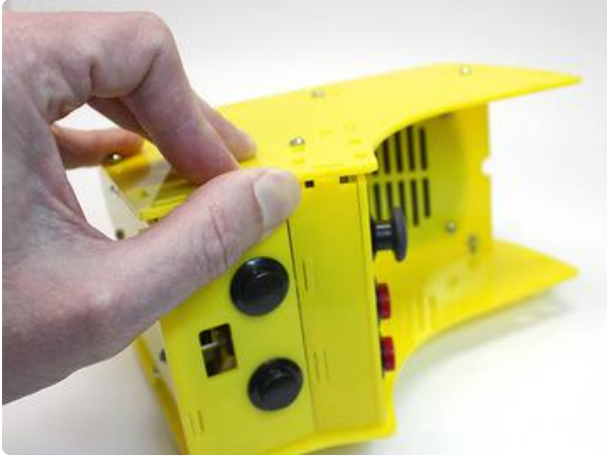

Install this fascia piece in a similar manner, then tighten the side screw back as it was.

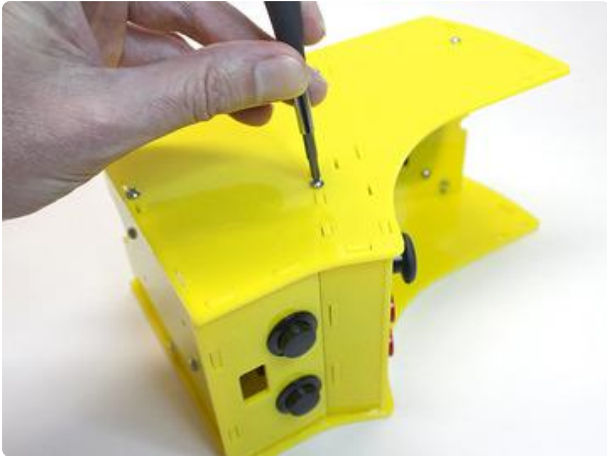

Loosen a side screw at the top. Same routine: screw tip flush with nut face, so you can flex this side up just a little bit.

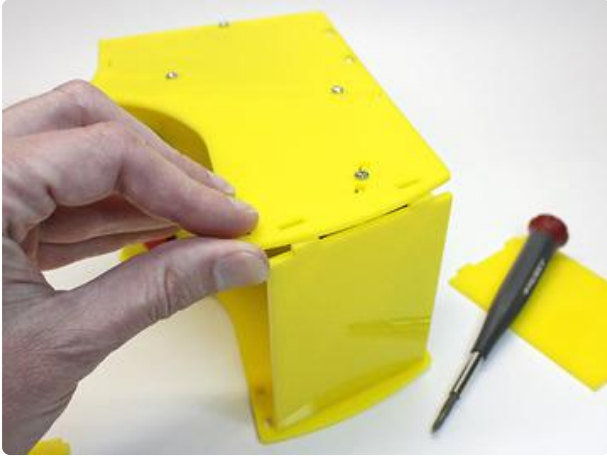

Insert the “roof” of the cabinet. The roof and back pieces are similar in size, but the tabs are spaced differently, so only the correct piece will fit.

As before, if you need a little extra working room, you can partway unscrew the opposite side.



Slot the marquee into place, then re-tighten the top screw.

So close! Isn't it adorable?

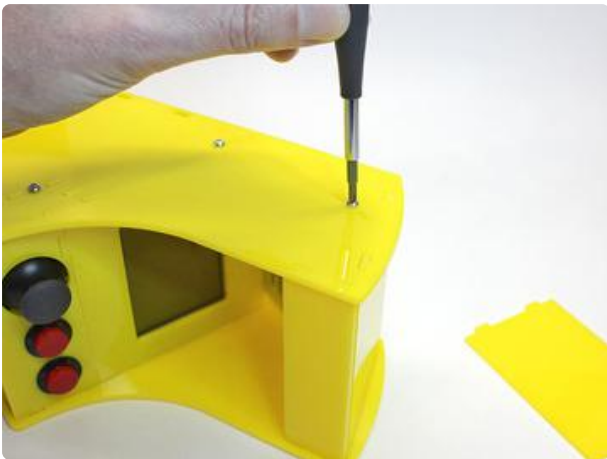

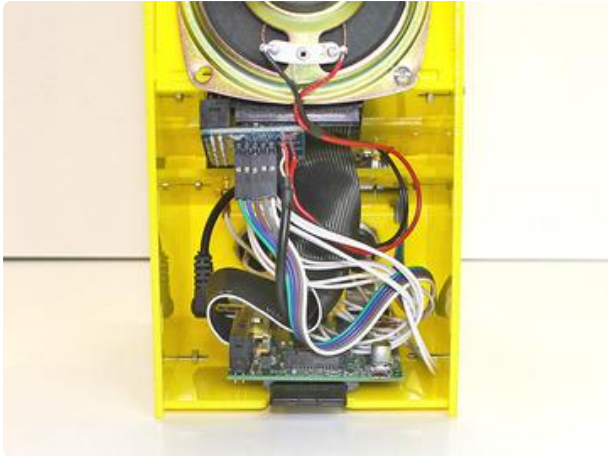

Stuff the wires into the back of the case, being careful not to dislodge the Cupcade board.

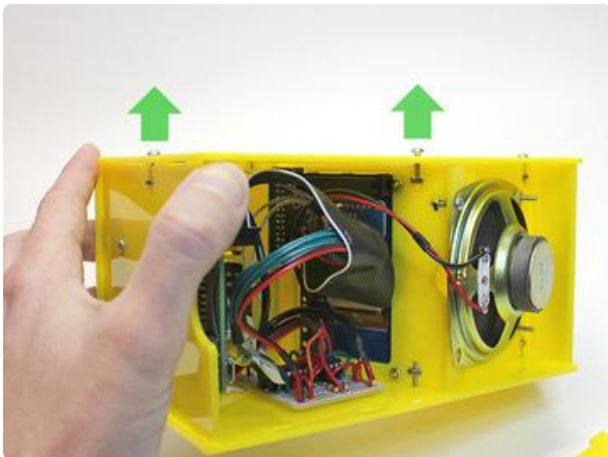

To install the back piece, you'll need to loosen two screws: the bottom and rear-most positions.

This piece pops into place like all the others.

When you're done, go around the whole case and make sure all the screws are snug. Not crazy tight...you don't want to crack the plastic...just tight enough to stay in place.

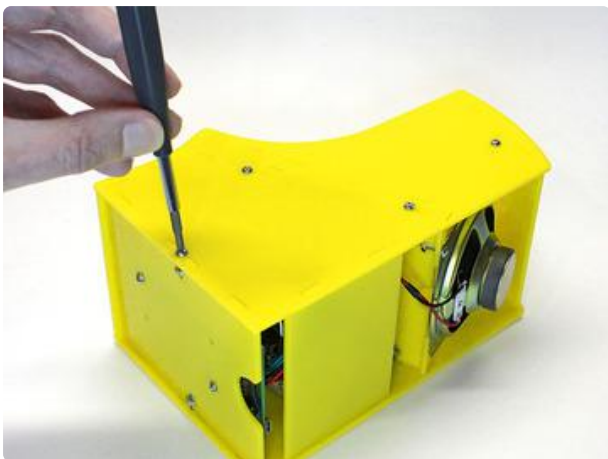



Insert the SD card, stand it up and connect power.

You can connect a USB keyboard at the front if you like. Some games with complex controls may require this, but for most classic games the basic stick-and-buttons are sufficient. The game selection menu and even shutdown can be accessed using combinations of these buttons.



Fire it up...see how it goes!

If everything works, that's great, you're done!

Remember: hold both the credit and start buttons for a few seconds to exit MAME and return to the game selection menu. Hold them again to exit the menu and shutdown the system.



Customize the case if you like. Stickers, paint markers or vinyl cut decals make it your own!

If the system does not boot...

If the system previously booted during the dry run but doesn't start this time around, remove the back of the case and check for the following:

- Is the underside of the Cupcade board contacting anything metal?
- Is the Cupcade board properly aligned with the header on the back of the PiTFT?
- Have any of the wires broken off or come unplugged? How about the joystick? Are the wires still in place and in the correct positions?
- Is the SD card firmly seated in place, or has it wiggled loose?

My Cupcade rocks back and forth when stood up.

Loosen all 8 screws on the sides. A mere 1/4 to 1/2 turn or so...we're not dismantling the case, just realigning things.

Stand the case upright and press down gently on top, so all four corners make contact with the table. With your free hand, tighten each of the side screws back as it was.

Installing ROMs

Cupcade — being based on RetroPie — does not come with games installed. However it's easy to install all manner of game system ROMs over the network.

Freely-distributable “homebrew” games have been developed for most gaming consoles, and even a few that could work with arcade hardware. In a few rare cases, such as the Vectrex system, the games were legitimately released into the public domain before the company folded. Try a Google search for a game system that appeals to you, such as “NES homebrew ROM” or “Atari homebrew ROM” and see what you can uncover.

Some Free MAME (Arcade) ROMs

When testing Cupcade, you'll want to have a game to play! There are a few free non-commercial ROMs available for testing your setup available. Visit the page at <http://mamedev.org/roms/> (<https://adafru.it/dfS>) and download the Robby Roto (horizontal video) or Super Tank (vertical video) ROMs.

Neither runs quite perfectly on the Cupcade (they use different screen resolutions) but are sufficient for testing the sound, buttons and joystick.



When testing Cupcade, you'll want to have a game to play! There are a few free non-commercial ROMs available for testing your setup available. Visit the page at <http://mamedev.org/roms/> (<https://adafru.it/dfS>) and download the Robby Roto (horizontal video) or Super Tank (vertical video) ROMs.

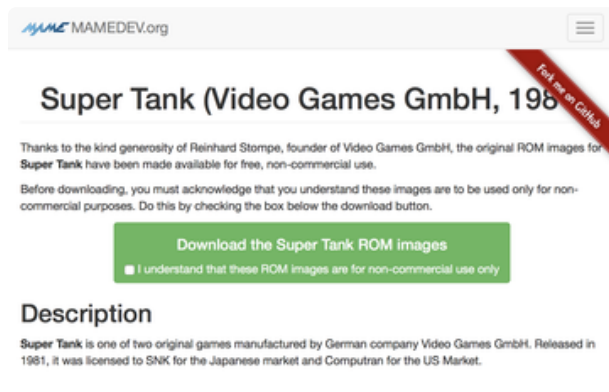

Neither runs quite perfectly on the Cupcade (they use different screen resolutions) but are sufficient for testing the sound, buttons and joystick.

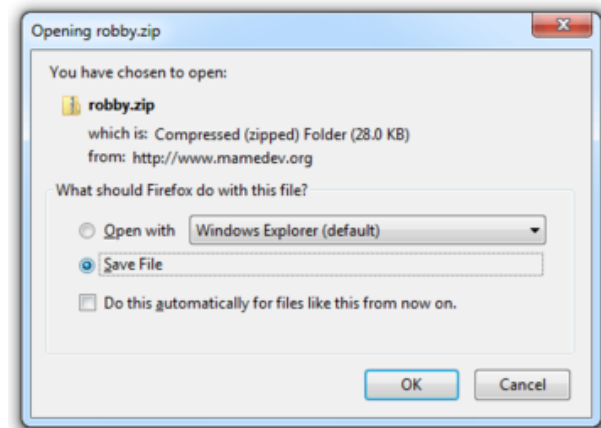

Don't decompress the ZIP files! Keep the ROM files in the ZIP!

Moving ROMs Over the Network

The Pi system should appear on your network as `retroPie.local`, where it appears as a SMB file server.

If using a Windows system and it doesn't recognize the "retropie.local" system on the network, you may need to install the Zeroconf software [as explained in this guide \(https://adafru.it/IPE\)](https://adafru.it/IPE).

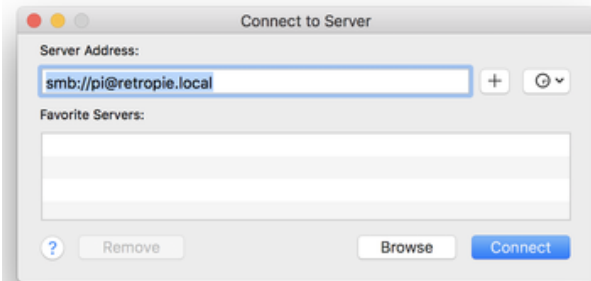

Here's how one typically connects from a Mac, using the Finder's Go→Connect to Server... option. Windows, Linux will have their own equivalent functions.

When prompted, connect as a guest rather than a registered user. This should then present a list of volumes to mount. Pick "roms," then "OK."

(If this doesn't work for you, try connecting as a registered user, with "pi" and "raspberrypi" as the username and password, respectively.)

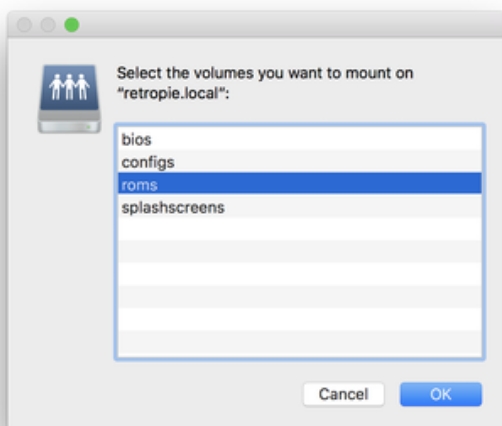
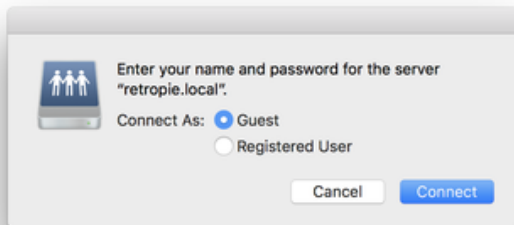

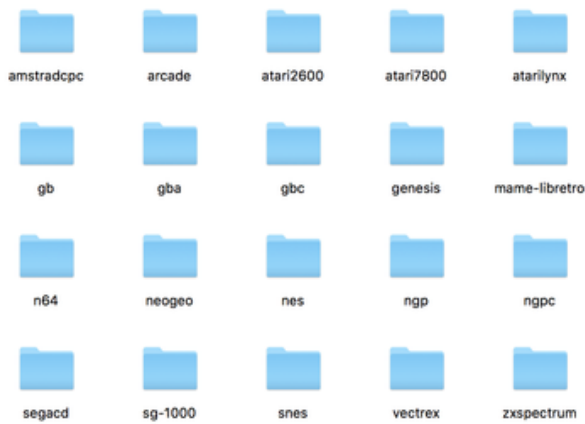

You'll be greeted with a collection of folders, one for each type of system that RetroPie can emulate.

MAME ROMs should go in the "mame-libretro" folder, NES ROMs in the "nes" folder, and so forth.

Eject the "roms" volume when you're finished.



RetroPie doesn't pick up on the fact you've installed new ROMs for a system... one extra step is needed...

Navigate to RetroPie's main menu and select the "Quit" option. In the resulting menu, select "Restart EmulationStation."

When the main RetroPie screen starts up again, you can cycle through the newly-enabled systems when moving the joystick right or left.



Downloads

Custom Cabinet Art

Looking to create custom artwork for the sides, marquee and display/control bezels? Here's an artwork file (PDF format) you can use as a template:

cupcade-gen3-cab-art.pdf

<https://adafru.it/ARq>

Same, for first- and second-generation Cupcades:

cupcade-cab-art.pdf

<https://adafru.it/dD9>

If making vinyl stickers for the sides, you'll probably want holes for just the screws, not every slot. It's all there for reference though and you can delete the bits you're not using. For the marquee and top/front surfaces, stickers might fare better without the assembly tabs.

Blue outlines show the areas obscured by the buttons or screw heads, and also the ~3mm lip along the front edge of the control bezel. (I apologize for the screw heads, but they had to go somewhere, and I took great pains to minimize the number.)

For a smoother appearance, orient and align the screen and joystick bezels to match your setup, then make a single combined sticker with cutouts for the screen and controls. You could even keep going and make this wrap all the way down the front in a single unbroken piece, though it might make assembling the case extra tricky.

Custom Cabinet

Want to laser cut your own custom design? You can start with our Illustrator file to tweak and mod. Cut from 3mm acrylic. Black lines are cuts, red are scored (vector "kiss cut"), blue is for documentation only (do not cut, score or engrave).

cupcade_gen3_case.zip

<https://adafru.it/ARr>

Same, for first- and second-generation Cupcades:

cupcade_case.zip

<https://adafru.it/oBs>

Cupcade Enclosure is by Phillip Burgess and is released under Creative Commons license Share Alike-Attribution Required