

DESCRIPTION: HIGH DENSITY MALE - VERTICAL DIP SOLDER

DIMENSIONS

Insulator Material	No. OF PINS	A	B	C	D	E	F	G	H
PA9T	15	1.213	0.984	0.666	0.329	0.090	0.756	0.496	0.429
		30.80	24.99	16.92	8.36	2.29	19.20	12.60	10.90
PA9T	26	1.541	1.312	0.994	0.329	0.090	1.091	0.496	0.429
		39.15	33.32	25.25	8.36	2.29	27.70	12.60	10.90
PA9T	44	2.087	1.852	1.533	0.329	0.090	1.618	0.496	0.429
		53.00	47.04	38.95	8.36	2.29	41.10	12.60	10.90
PA6T	62	2.732	2.500	2.181	0.329	0.095	2.256	0.496	0.429
		69.40	63.50	55.40	8.36	2.41	57.30	12.60	10.90
PA6T	78	2.638	2.406	2.079	0.445	0.095	2.169	0.606	0.526
		67.00	61.10	52.80	11.30	2.41	55.10	15.40	13.35

4 ROWS

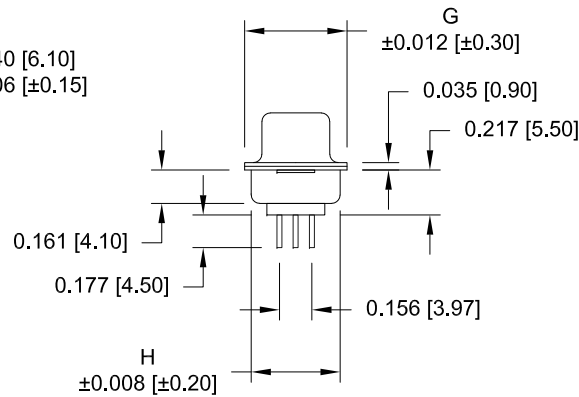
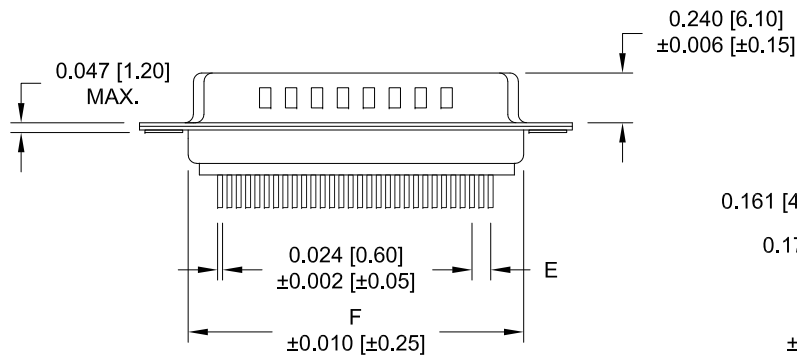
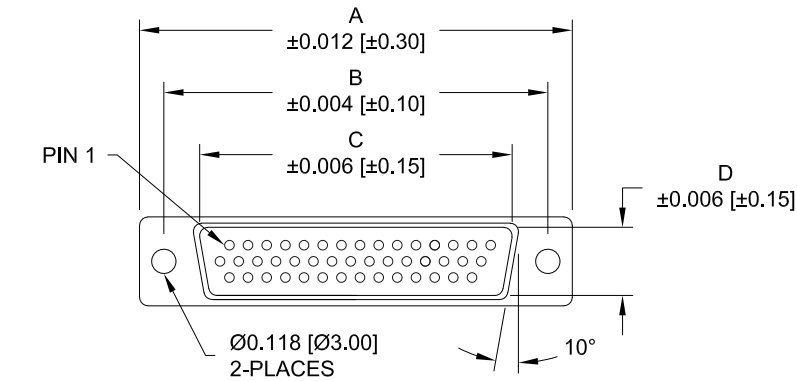

180-YYY-113RYY1

- SERIES \_\_\_\_\_
- POSITIONS \_\_\_\_\_
- 015 \_\_\_\_\_
- 026 \_\_\_\_\_
- 044 \_\_\_\_\_
- 062 \_\_\_\_\_
- 078 \_\_\_\_\_
- GENDER \_\_\_\_\_
- 1 = MALE
- TERMINATION \_\_\_\_\_
- 1 = VERTICAL DIP SOLDER
- SHELL PLATING \_\_\_\_\_
- 3 = NICKEL (GROUND INDENTS)
- RoHS COMPLIANT (260°C) \_\_\_\_\_
- HARDWARE OPTIONS \_\_\_\_\_
- 00 = NO HARDWARE
- 01 = .098" CLINCH NUT (BOARD SIDE)
- 02 = .236" CLINCH NUT (BOARD SIDE)
- 03 = .236" CLINCH NUT (MATING SIDE)
- 05 = .237 4-40 BOARD LOCK
- 90 = .237 4-40 BOARD LOCK FOR 0.093" BOARD MAX.
- 91 = .237 4-40 SPACER/BOARD LOCK
- 92 = .237 4-40 SPACER/BOARD LOCK FOR 0.093" BOARD MAX.
- PLATING OPTIONS \_\_\_\_\_
- 1 = GOLD FLASH
- A = 30u" GOLD MATING AREA, GOLD FLASH OVERALL

MATERIAL:

- SHELL: STEEL, NICKEL PLATED
- INSULATOR: GLASS FILLED THERMOPLASTIC, UL 94V-O RATED
- CONTACT: BRASS, GOLD PLATED OVER NICKEL

ELECTRICAL:

- CURRENT RATING: 3 AMPS
- CONTACT RESISTANCE: 15 mOhms Max.
- INSULATION RESISTANCE: 1,000 MOhms min.
- VOLTAGE: 500VAC FOR 1 MINUTE
- TEMPERATURE: -50° C TO 100° C

DO NOT SCALE FROM DRAWING

	THESE DRAWINGS AND SPECIFICATIONS ARE THE PROPERTY OF NorComp AND SHALL NOT BE REPRODUCED, COPIED OR USED AS THE BASIS FOR THE MANUFACTURE OF SALE OF APPARATUS WITHOUT WRITTEN PERMISSION.		DRAWN: PAM JENKINS	DATE: 09-12-05
			SCALE: NTS	SHEET 1 OF 3
			DWG NO. 180-YYY-113RYY1	REV 19

RoHS COMPLIANT

DESCRIPTION: PCB LAYOUT - VERTICAL - MALE

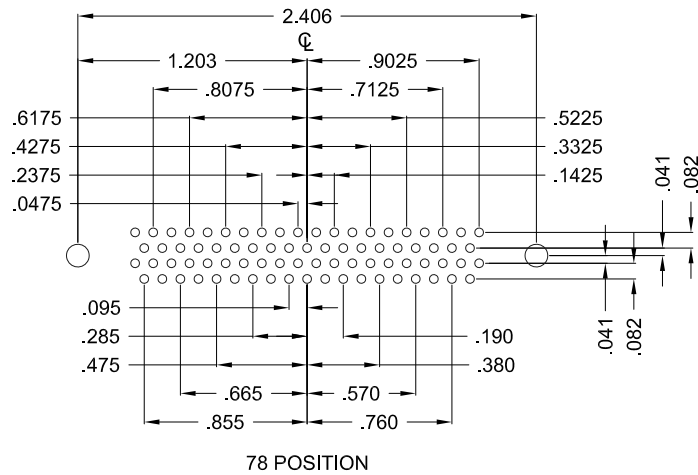
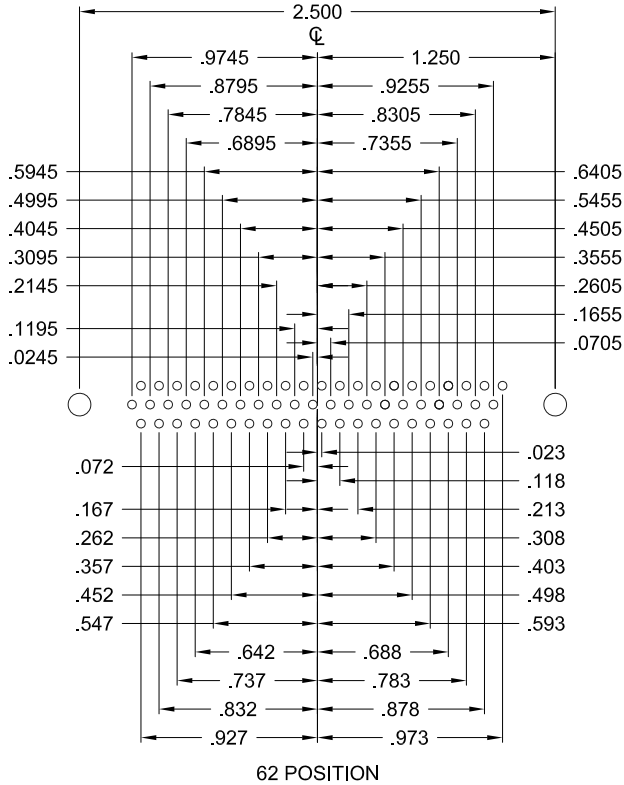
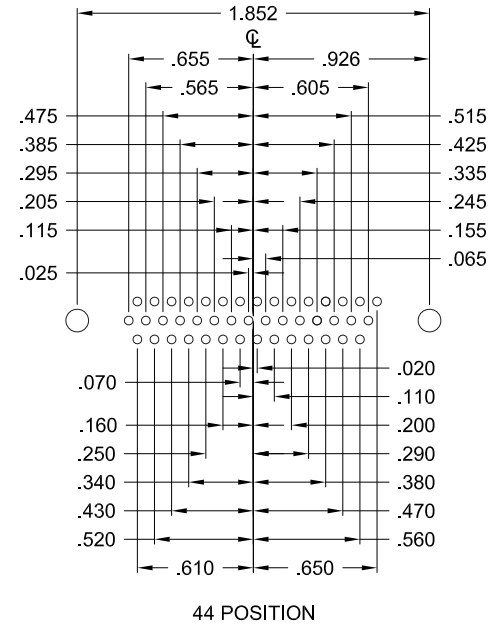
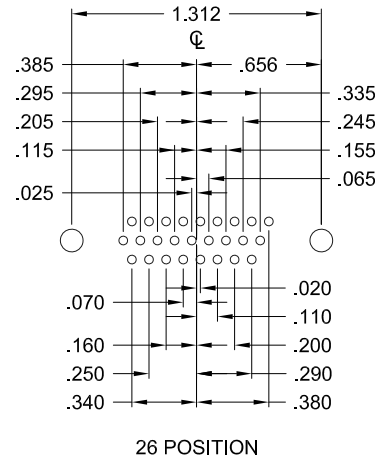
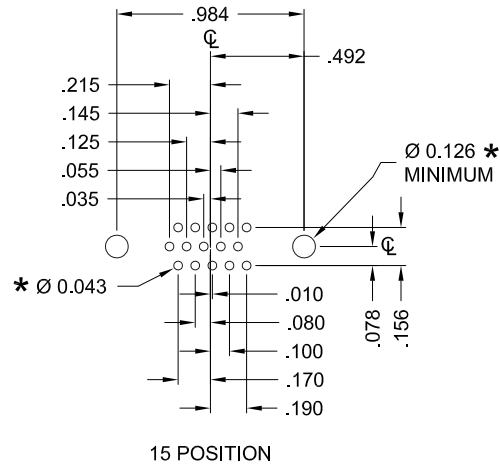

HOLE PATTERN SHOWN ARE FOR MALE

UNITS = inch

\* TYP. SUGGESTED SIZE MAY NOT BE SUITABLE FOR ALL APPLICATIONS

DO NOT SCALE FROM DRAWING

	THESE DRAWINGS AND SPECIFICATIONS ARE THE PROPERTY OF NorComp AND SHALL NOT BE REPRODUCED, COPIED OR USED AS THE BASIS FOR THE MANUFACTURE OF SALE OF APPARATUS WITHOUT WRITTEN PERMISSION.		DRAWN: <b>PAM JENKINS</b>	DATE: <b>09-12-05</b>
	<h1>NorComp</h1>		SCALE: NTS	SHEET OF 2 3
DWG NO. <b>180-YYY-113RYY1</b>				