

GLASS PASSIVATED RECTIFIER

VOLTAGE RANGE 50 to 100 Volts CURRENT 1.5 Amperes

FEATURES

- * Low cost
- * Low leakage
- * Low forward voltage drop
- * High current capability
- * Glass passivated junction

MECHANICAL DATA

- * Case: Molded plastic
- * Epoxy: Device has UL flammability classification 94V-0
- * Lead: MIL-STD-202E method 208C guaranteed
- * Mounting position: Any
- * Weight: 0.38 gram

MAXIMUM RATINGS AND ELECTRICAL CHARACTERISTICS

Ratings at 25 °C ambient temperature unless otherwise specified.
Single phase, half wave, 60 Hz, resistive or inductive load.
For capacitive load, derate current by 20%.

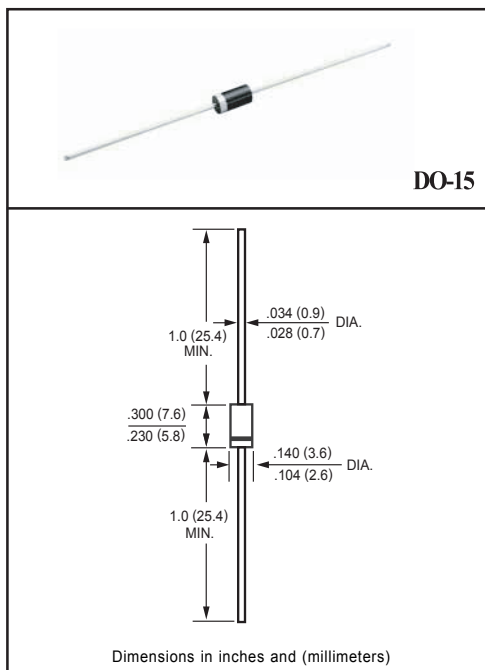

MAXIMUM RATINGS (At $T_A = 25^\circ\text{C}$ unless otherwise noted)

RATINGS	SYMBOL	1N5391G	1N5392G	1N5393G	1N5394G	1N5395G	1N5396G	1N5397G	1N5398G	1N5399G	UNITS	
Maximum Recurrent Peak Reverse Voltage	V_{RRM}	50	100	200	300	400	500	600	800	1000	Volts	
Maximum RMS Voltage	V_{RMS}	35	70	140	210	280	350	420	560	700	Volts	
Maximum DC Blocking Voltage	V_{DC}	50	100	200	300	400	500	600	800	1000	Volts	
Maximum Average Forward Rectified Current .375" (9.5mm) lead length at $T_L = 70^\circ\text{C}$	I_o						1.5					Amps
Peak Forward Surge Current 8.3 ms single half sine-wave superimposed on rated load (JEDEC method)	I_{FSM}						50					Amps
Typical Current Squared Time	I^2T						10.37					A^2S
Typical Junction Capacitance (Note)	C_J						20					pF
Typical Thermal Resistance	$R_{\theta JA}$						50					$^\circ\text{C}/\text{W}$
Operating and Storage Temperature Range	T_J, T_{STG}						-65 to + 175					$^\circ\text{C}$

ELECTRICAL CHARACTERISTICS (At $T_A = 25^\circ\text{C}$ unless otherwise noted)

CHARACTERISTICS	SYMBOL	1N5391G	1N5392G	1N5393G	1N5394G	1N5395G	1N5396G	1N5397G	1N5398G	1N5399G	UNITS	
Maximum Instantaneous Forward Voltage at 1.5A DC	V_F						1.1					Volts
Maximum DC Reverse Current @ $T_A = 25^\circ\text{C}$	I_R						5.0					μAmps
at Rated DC Blocking Voltage @ $T_A = 150^\circ\text{C}$							5.0					mAmps
Maximum Full Load Reverse Current Average, Full Cycle .375" (9.5mm) lead length at $T_L = 75^\circ\text{C}$							30					μAmps

NOTES : Measured at 1 MHz and applied reverse voltage of 4.0 volts

RATING AND CHARACTERISTIC CURVES(1N5391G THRU 1N5399G)

FIG. 1 - TYPICAL FORWARD CURRENT DERATING CURVE

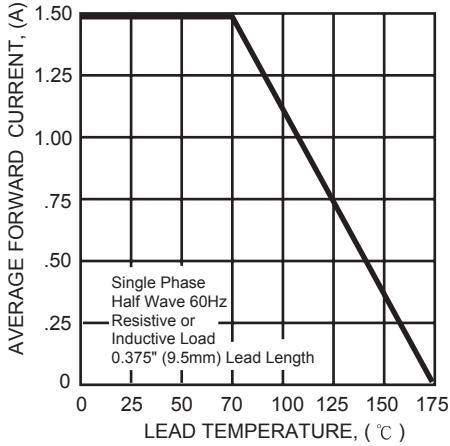

FIG. 2 - MAXIMUM INSTANTANEOUS FORWARD CHARACTERISTICS

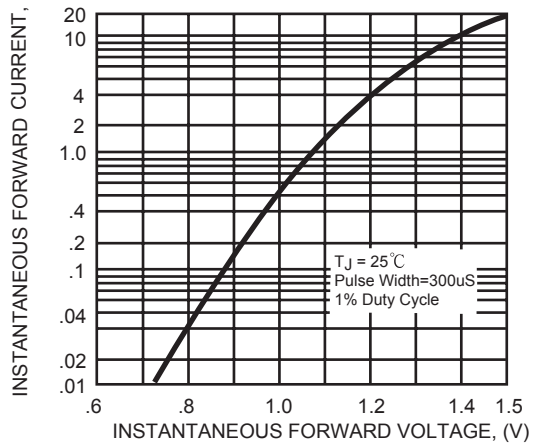

FIG. 3 - MAXIMUM NON-REPETITIVE FORWARD SURGE CURRENT

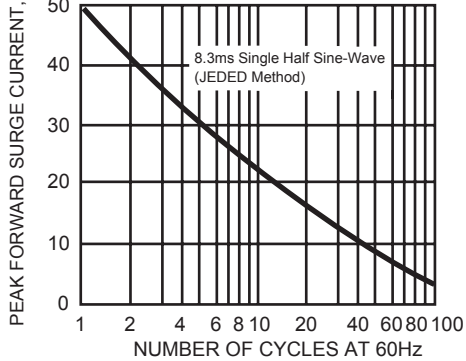

FIG. 4 - TYPICAL JUNCTION CAPACITANCE

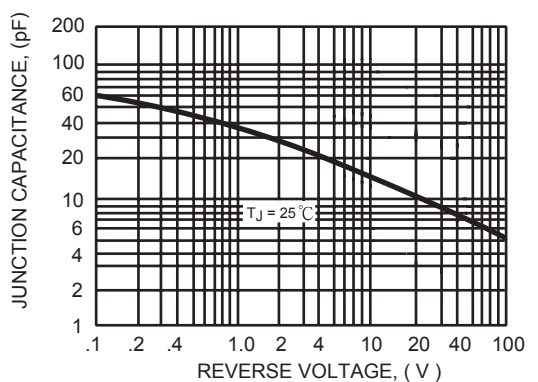
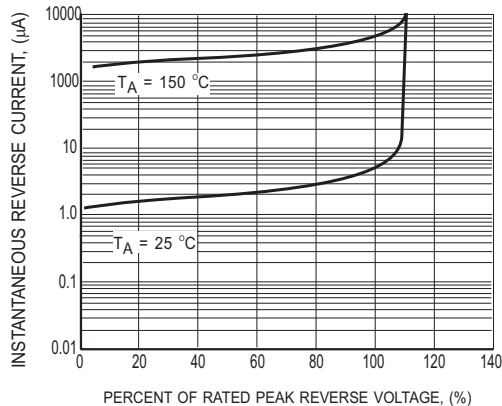

FIG.5 MAXIMUM REVERSE CHARACTERISTICS





1. Internal Circuit



2. Marking on the body

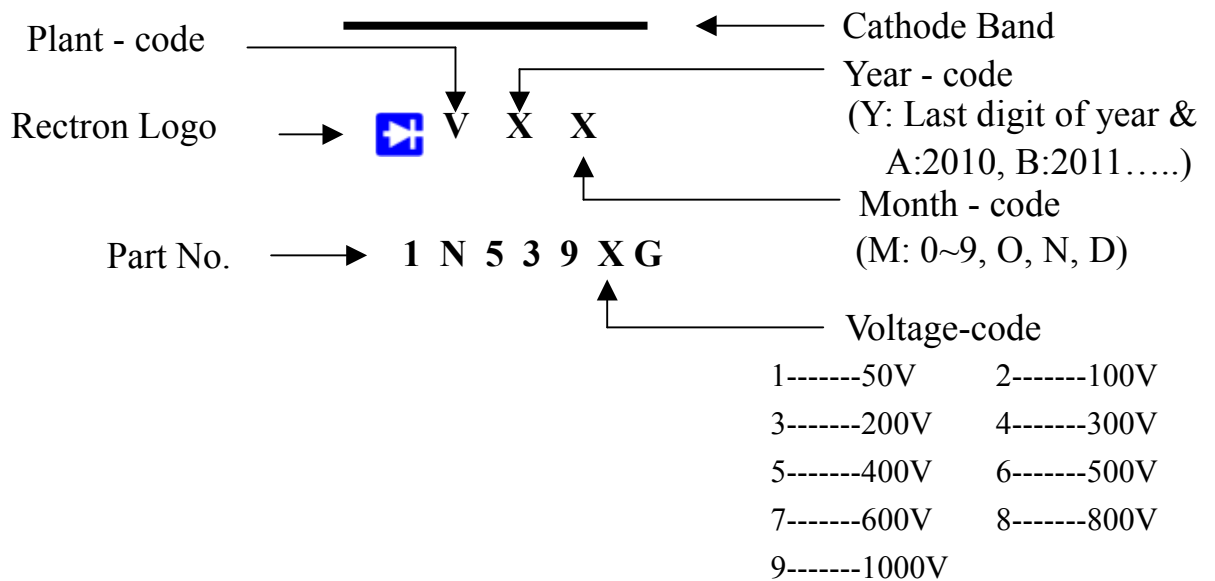

PACKAGING OF DIODE AND BRIDGE RECTIFIERS

BULK PACK

PACKAGE	PACKING CODE	EA PER BOX	INNER BOX SIZE (mm)	CARTON SIZE (mm)	EA PER CARTON	GROSS WEIGHT(Kg)
DO-15	-B	500	194*84*21	415*220*255	25,000	12.74

REEL PACK

PACKAGE	PACKING CODE	EA PER REEL	EA PER INNER BOX	COMPONENT SPACE (mm)	TAPE SPACE (mm)	REEL DIA (mm)	CARTON SIZE (mm)	EA PER CARTON	GROSS WEIGHT(Kg)
DO-15	-T	4,000	4,000	5.0	52	330	355*350*335	16,000	10.05

AMMO PACK

PACKAGE	PACKING CODE	REEL (EA)	COMPONENT SPACE(mm)	TAPE SPACE (mm)	BOX SIZE (mm)	CARTON SIZE(mm)	CARTON (EA)	GROSS WEIGHT (Kg)
DO-15	-F	1,500	5.0	52	255*73*100	400*268*225	15,000	8.8