

SCHOTTKY BARRIER RECTIFIER

VOLTAGE RANGE 20 to 100 Volts CURRENT 1.0 Ampere

FEATURES

- * Low power loss, high efficiency
- * Low leakage
- * Low forward voltage
- * High current capability
- * High speed switching
- * High surge capability
- * High reliability

MECHANICAL DATA

- * Case: Molded plastic
- * Epoxy: Device has UL flammability classification 94V-0
- * Lead: MIL-STD-202E method 208C guaranteed
- * Mounting position: Any
- * Weight: 0.12 gram

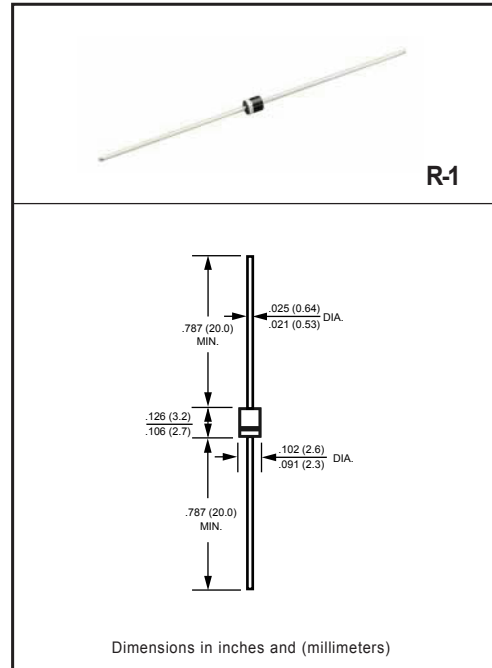

MAXIMUM RATINGS AND ELECTRICAL CHARACTERISTICS

Ratings at 25 °C ambient temperature unless otherwise specified.
Single phase, half wave, 60 Hz, resistive or inductive load.
For capacitive load, derate current by 20%.

MAXIMUM RATINGS (@ TA=25 °C unless otherwise noted)

RATINGS	SYMBOL	1S20	1S30	1S40	1S50	1S60	1S80	1S100	UNITS
Maximum Recurrent Peak Reverse Voltage	V _{RRM}	20	30	40	50	60	80	100	Volts
Maximum RMS Voltage	V _{RMS}	14	21	28	35	42	56	70	Volts
Maximum DC Blocking Voltage	V _{DC}	20	30	40	50	60	80	100	Volts
Maximum Average Forward Rectified Current .375" (9.5mm) lead length	I _O	1.0							Amps
Peak Forward Surge Current 8.3 ms single half sine-wave superimposed on rated load (JEDEC method)	I _{FSM}	20							Amps
Typical Thermal Resistance (Note 3)	R _{θJA}	60							°C/W
	R _{θJL}	20							
Typical Junction Capacitance (Note 1)	C _J	110							pF
Operating Temperature Range	T _J	150							°C
Storage Temperature Range	T _{STG}	-55 to + 150							°C

ELECTRICAL CHARACTERISTICS (@TA=25 °C unless otherwise noted)

CHARACTERISTICS	SYMBOL	1S20	1S30	1S40	1S50	1S60	1S80	1S100	UNITS
Maximum Instantaneous Forward Voltage at 1.0A DC	V _F	.55			.70		.85		Volts
Maximum Average Reverse Current at Rated DC Blocking Voltage	I _R	@T _A = 25°C							mAmps
		@T _A = 100°C							10

- NOTES : 1. Measured at 1 MHz and applied reverse voltage of 4.0 volts.
2. "Fully ROHS compliant", "100% Sn plating (Pb-free)".
3. Thermal Resistance : At 9.5mm lead lengths, PCB mounted.

RATING AND CHARACTERISTICS CURVES (1S20 THRU 1S100)

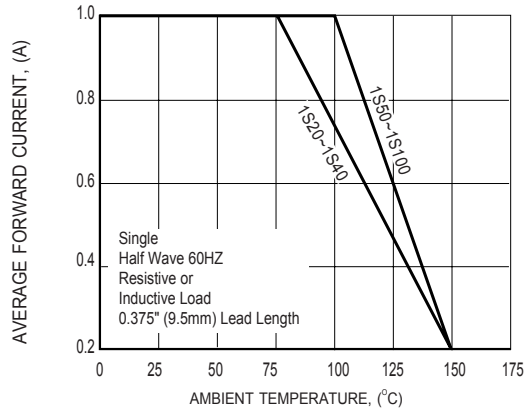

FIG.1 TYPICAL FORWARD CURRENT DERATING CURVE

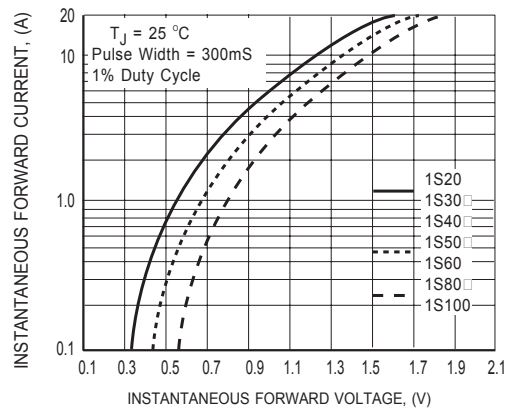

FIG.2 TYPICAL INSTANTANEOUS FORWARD CHARACTERISTICS

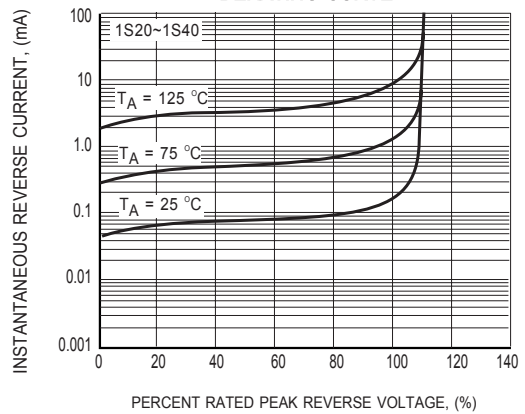

FIG.3 TYPICAL REVERSE CHARACTERISTICS

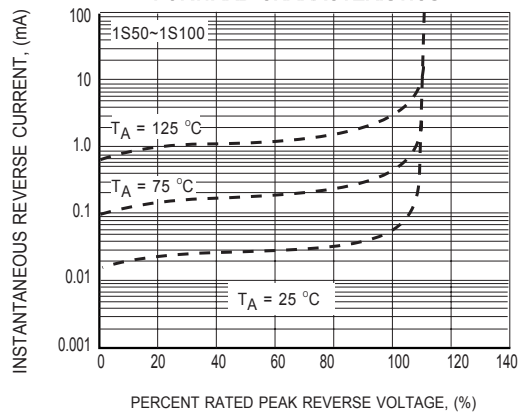

FIG.3 TYPICAL REVERSE CHARACTERISTICS

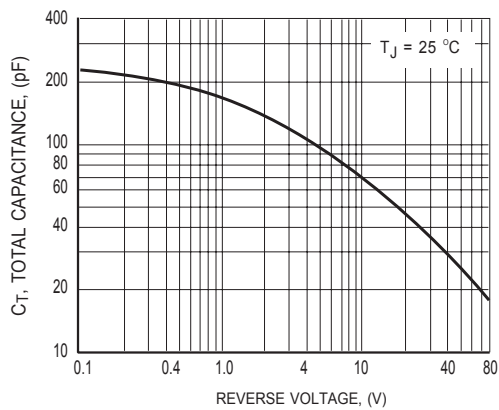

FIG.4 TYPICAL JUNCTION CAPACITANCE

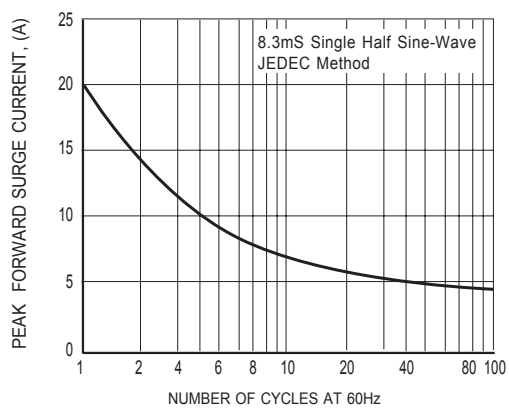

FIG.5 MAXIMUM NON-REPETITIVE FORWARD SURGE CURRENT