

**SCHOTTKY BARRIER RECTIFIER**

**VOLTAGE RANGE 20 to 100 Volts CURRENT 1.0 Ampere**

**FEATURES**

- \* Low power loss, high efficiency
- \* Low leakage
- \* Low forward voltage
- \* High current capability
- \* High speed switching
- \* High surge capability
- \* High reliability

**MECHANICAL DATA**

- \* Case: Molded plastic
- \* Epoxy: Device has UL flammability classification 94V-0
- \* Lead: MIL-STD-202E method 208C guaranteed
- \* Mounting position: Any
- \* Weight: 0.12 gram

**MAXIMUM RATINGS AND ELECTRICAL CHARACTERISTICS**

Ratings at 25 °C ambient temperature unless otherwise specified.  
Single phase, half wave, 60 Hz, resistive or inductive load.  
For capacitive load, derate current by 20%.

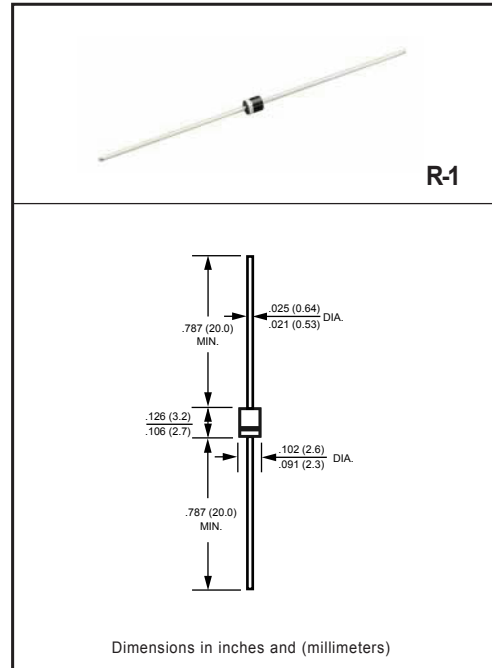

**MAXIMUM RATINGS (@ TA=25 °C unless otherwise noted)**

RATINGS	SYMBOL	1S20	1S30	1S40	1S50	1S60	1S80	1S100	UNITS
Maximum Recurrent Peak Reverse Voltage	V <sub>RRM</sub>	20	30	40	50	60	80	100	Volts
Maximum RMS Voltage	V <sub>RMS</sub>	14	21	28	35	42	56	70	Volts
Maximum DC Blocking Voltage	V <sub>DC</sub>	20	30	40	50	60	80	100	Volts
Maximum Average Forward Rectified Current .375" (9.5mm) lead length	I <sub>O</sub>	1.0							Amps
Peak Forward Surge Current 8.3 ms single half sine-wave superimposed on rated load (JEDEC method)	I <sub>FSM</sub>	20							Amps
Typical Thermal Resistance (Note 3)	R <sub>θJA</sub>	60							°C/W
	R <sub>θJL</sub>	20							
Typical Junction Capacitance (Note 1)	C <sub>J</sub>	110							pF
Operating Temperature Range	T <sub>J</sub>	150							°C
Storage Temperature Range	T <sub>STG</sub>	-55 to + 150							°C

**ELECTRICAL CHARACTERISTICS (@TA=25 °C unless otherwise noted)**

CHARACTERISTICS	SYMBOL	1S20	1S30	1S40	1S50	1S60	1S80	1S100	UNITS
Maximum Instantaneous Forward Voltage at 1.0A DC	V <sub>F</sub>	.55			.70		.85		Volts
Maximum Average Reverse Current at Rated DC Blocking Voltage	I <sub>R</sub>	@T <sub>A</sub> = 25°C							mAmps
		@T <sub>A</sub> = 100°C							10

- NOTES : 1. Measured at 1 MHz and applied reverse voltage of 4.0 volts.  
2. "Fully ROHS compliant", "100% Sn plating (Pb-free)".  
3. Thermal Resistance : At 9.5mm lead lengths, PCB mounted.

## RATING AND CHARACTERISTICS CURVES ( 1S20 THRU 1S100 )

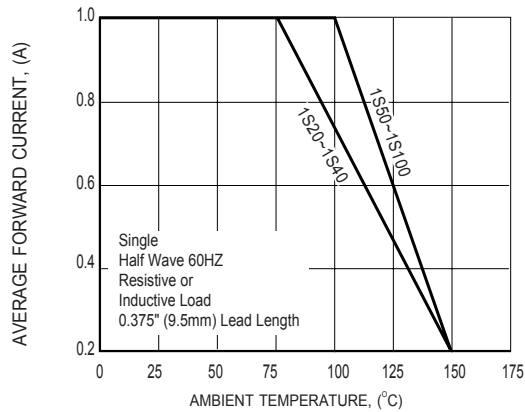

**FIG.1 TYPICAL FORWARD CURRENT DERATING CURVE**

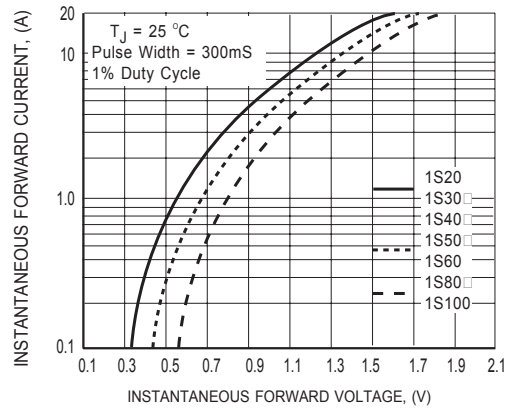

**FIG.2 TYPICAL INSTANTANEOUS FORWARD CHARACTERISTICS**

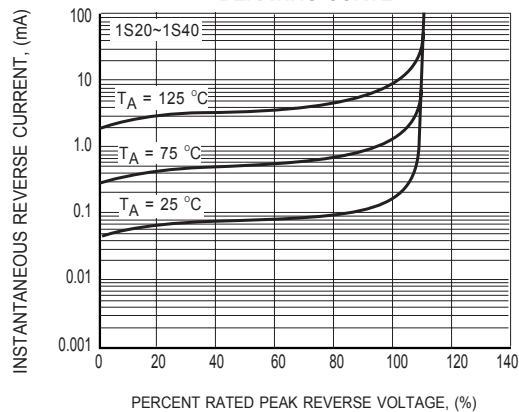

**FIG.3 TYPICAL REVERSE CHARACTERISTICS**

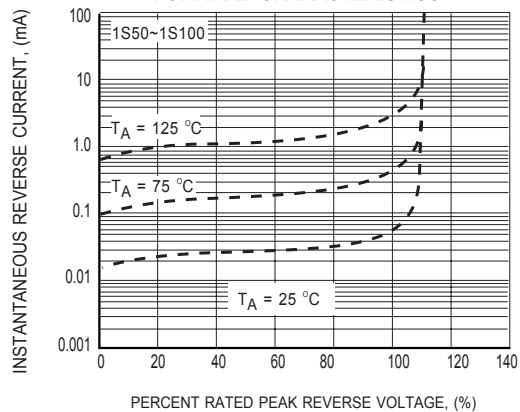

**FIG.3 TYPICAL REVERSE CHARACTERISTICS**

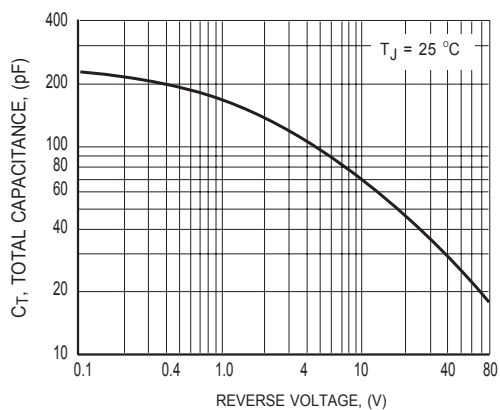

**FIG.4 TYPICAL JUNCTION CAPACITANCE**

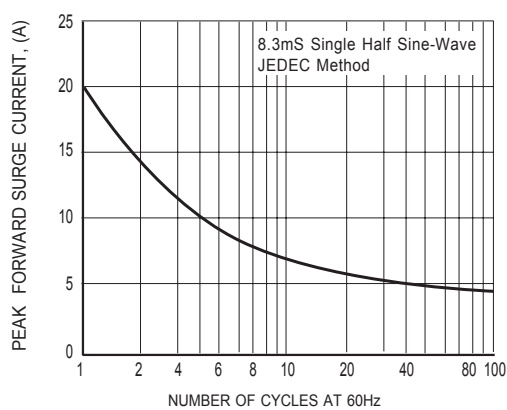

**FIG.5 MAXIMUM NON-REPETITIVE FORWARD SURGE CURRENT**