

SBE® 320 / SBX® 350 Connectors

Up to 550 Amps



SBE® and SBX® connectors can integrate up to 8 auxiliary power/signal contacts along with the two primary power circuits. Sequencing within auxiliary positions is possible using the 4 pin lengths available in the 1x4 auxiliary connector. SBE® and SBX® offer touch safe housings.

- **Meets EN1175:2020**

- **Silver Plated Wire Contacts up to 350 mcm (185 mm²)**

Allows low resistance UL rated currents up to 550 amps per pole

- **Up to 8 Auxiliaries**

Enables intelligent power switching, CAN and interlock loop circuitry, as well as power up to 20 amps per pole. Auxiliaries are all Last-mate/First-break relative to power contacts.

SBE® 320 / SBX® 350 ORDERING INFORMATION

SBE® 320 / SBX® 350 Housings

The largest size of SBE®, X, O style housing. SBE® housings are molded from a chemical resistant PBT. SBX® housings are molded from PC. SBE® 320 and SBX® 350 housings of the same Voltage Color-Code cannot be mated. SBX® 350 housings do not meet EN1175:2020 requirements for industrial trucks.

Description	SBE® 320 Part Numbers		SBX® 350 Part Numbers	
	Part Number	Part Number	Part Number	Part Number
Minimum Quantity	100	25	100	25
Yellow	2-8171G6	E6362	2-7249G6	6362
Orange	2-8171G7	E6339	2-7249G7	6339
Red	2-8171G3	E6352	2-7249G3	6352
Gray	2-8171G1	E6350	2-7249G1	6350
Blue	2-8171G2	E6351	2-7249G2	6351
Green	2-8171G4	E6353	2-7249G4	6353
Black	2-8171G5	E6361	2-7249G5	6361
Brown	2-8171G8	E6336	N/A	N/A
Purple	2-8171G9	E6349	N/A	N/A

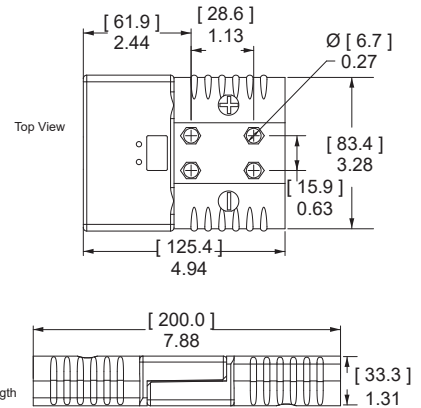

SBE® 320 / SBX® 350 Silver Plated Primary Power Wire Contacts

Silver plated contacts offer superior electrical performance and durability up to 10,000 mating cycles. See reducing bushings in accessory section for smaller wires.

AWG	mm ²	Loose Piece Part Numbers		Dimensions								
				- A -		- B -		- C -		- D -		
Minimum Quantity				inches	mm	inches	mm	inches	mm	inches	mm	
300/350 mcm	185	-	6358-BK	6358 *	3.03	76.96	0.88	22.20	0.75	19.05	1.25	31.80
4/0	120	6356-BK	-	6356 *	3.10	78.74	0.75	19.05	0.64	16.26	1.25	31.80
3/0	95	6355-BK	-	6355 *	3.10	78.74	0.70	17.78	0.58	14.73	1.25	31.80
2/0	70	6354-BK	-	6354 *	3.10	78.74	0.64	16.26	0.49	12.45	1.25	31.80
2	35	6394-BK	-	6394 *	3.10	78.74	0.51	12.95	0.38	9.50	1.25	31.80

* Sold as pairs. 2 parts shipped for every 1 part ordered.

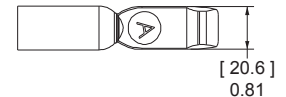
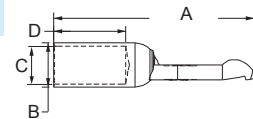

SBE® 320 DIN Standard Silver Plated Primary Power Wire Contacts

Crimp barrel O.D. are compliant with DIN standard tooling. Will also fit into SBX® 350 housings. Not recommended for cross mating with above typical contacts for SBE® & SBX®.

AWG	mm ²	Loose Piece Part Numbers		Dimensions							
				- A -		- B -		- C -		- D -	
				inches	mm	inches	mm	inches	mm	inches	mm
Minimum Quantity	200	50									
3/0	95	1341G3-BK	1341G3 *	2.89	73.41	0.78	19.81	0.59	14.99	0.94	23.88
2/0	70	1341G2-BK	1341G2 *	2.74	69.60	0.68	17.27	0.51	12.95	0.79	20.07
1/0	50	1341G1-BK	1341G1 *	2.65	67.31	0.57	14.48	0.43	10.92	0.79	20.07

* Sold as pairs. 2 parts shipped for every 1 part ordered.

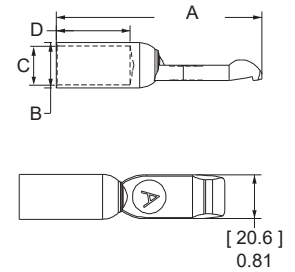

SBE® 320 / SBX® 350 CONNECTOR TEMPERATURE CHARTS - Temperature rise charts are based on a 25°C ambient temperature. [Current - Temperature Derating per IEC 60512-5-2 Test 5B](#)

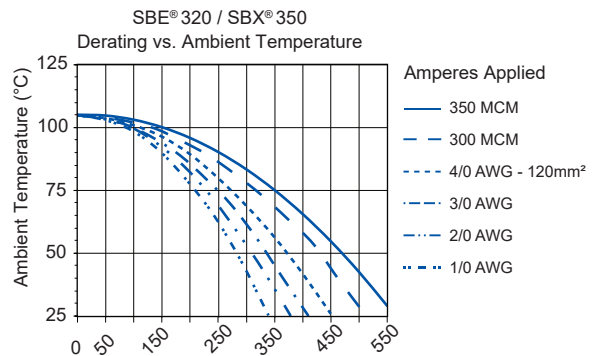
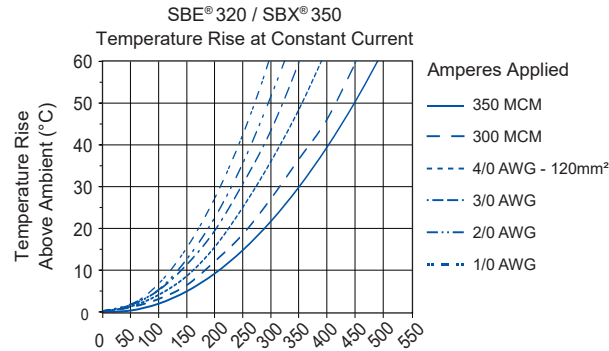

SBE® 320 / SBX® 350 InRush Current Curve Based on 40°C Rise

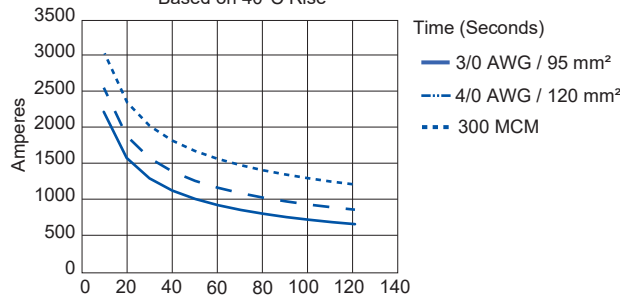

EN1175:2020 Rating	
Rated Current (A)	Cable cross-section (mm ²)
250	50
320	95
400	95

SBE® 320 / SBX® 350 CONNECTOR SPECIFICATIONS

ELECTRICAL	SBX® & SBE®		SBE® Only	MATERIALS	
Current Rating Amperes¹	USR	CNR	EN1175:2020	Housings	
Primary Power (350 MCM)	550	350	320	SBX® and Powerpole® Auxiliary Housings	Polycarbonate
Powerpole® Auxiliary (12 AWG)	20	20	N/A	SBE®, PPMX and 1x4 Auxiliary Housings	Polycarbonate / PBT blend
1x4 Auxiliary (12 AWG)	20	20	N/A		
PPMX (20 AWG)	5	5	N/A		
Voltage Rating AC/DC				Housing Flammability Rating	UL IEC (SBE® Only)
Primary Power (350 MCM)	600	600	150 ⁴	SBX® / SBE®	94 V-0 960°C (GWFI) / 850°C (GWIT)
Powerpole® Auxiliary (12 AWG)	600	600	150 ⁴		
1x4 Auxiliary (12 AWG)	600	600	N/A	Contact Materials	
PPMX (20 AWG)	600	600	N/A	Power Contacts	Au Plated Copper
				Powerpole® Auxiliary	Au or Sn - Copper Alloy
Dielectric Withstanding Voltage				1x4 Auxiliary Contacts	
Volts AC	2,200			Pin	Au Over NI - Copper Allow
* Average Mated Contact Resistance milliohms				Socket	Au Over NI - BeCu
2 1/2 " 350 MCM	0.05			Socket Body	Sn Over Ni, Copper Alloy
				Retention Clip	Stainless Steel
				PPMX Contacts	Gold Plated Copper Alloy

* Not UL rated

Contact Terminations³ - Crimp or Hand Solder

MECHANICAL

Wire Size Range	AWG	mm ²
Power Contacts	1/0 to 350 MCM	53.5 to 185
Auxiliary Contacts	24 to 10 AWG	0.25 to 5.3
Max Wire Insulation Diameter	in	mm
Power Contact	0.82 *	20.8 *
Powerpole® Auxiliary	0.175	4.45
1x4 Auxiliary	0.14	3.6
PPMX Auxiliary	0.09	2.29
Operating Temperature ²	°F	°C
SBX® Housing with all Auxiliary	-4 to 221	-20 to -105
SBE® Housing	-40 to 221	-40 to 105
SBX® Housing with Powerpole® Auxiliary Housings	-4 to 221	-20 to -105
SBE® Housing with 1x4 and PPMX Auxiliaries	-40 to 221	-40 to 105
Mating Cycles	Silver / Tin	Gold
Power Contacts	10,000	N/A
Powerpole® Auxiliary	10,000 / 1500	N/A
1x4 Auxiliary	N/A	10,000
PPMX Auxiliary	N/A	5,000
Average Mating	LBF	N
Main Connector Housing	37	165
Per Powerpole® Connector	5	22
Per 1x4 Auxiliary Housing	0.7	3
Per PPMX Housing	4.5	20
Min Contact / Spring Retention Force	150	667
Powerpole® Housing	25	111
1x4 Auxiliary Housing	10	44.5
PPMX Housing	12	53
Min Contact / Spring Retention Force	150	667
Powerpole® Housing	25	111
1x4 Auxiliary Housing	10	44.5
PPMX Housing	12	53
1x4 Auxiliary Housing	10	44.5
PPMX Housing	12	53

IEC INFORMATION

Connector Series	Configurations	Creepage / Clearance per IEC 60950-1	Material Group
SBE® 320	Unmated	5.6 mm	IIIa
	Mated	24.7 mm	

ATTRIBUTES	SBE® 320
AMP Rating AC/DC	320 Amp
Voltage Rating AC/DC (Steady State)	600 V AC/DC (Operational)
Breaking Capacity - AMP Rating / Cycles	275 Amp / 10 Cycles
Voltage Rating (Breaking Capacity)	220 VDC
FINGER Safety - Mated / Unmated	IEC 60529 - IP20
Wire Size Tested	120 mm ²
Contact Series Tested	6356
Climatic Testing (Cold, Heat & MFG)	IEC 60512 Test -11j, 11i & 11g
Cycle Life	IEC 60512 Test 9a - 5,000 Cycles
Mechanical Strength Impact	IEC 60512-5 @ 29.5 Inches Dropped 8 Times
Temperature Range	-20°C to 105°C -4°F to 221°F

PROTECTION

Touch Safety Main Connector Housing

IEC 60950 SBE® 320 Only	Pass
IEC 60529 SBE® 320 & SBX® 350	IP20



Note 1: See IEC60664-1 for working voltage

Note 2: Amp ratings are stated per position and based on all positions being fully loaded

1 - Based on 195°C rated or better cable of the largest size. Properly calibrated Anderson Power™ recommended tooling and 25°C ambient temperature

2 - limited by thermal properties of the connector plastic housing

3 - USE Anderson Power™ recommended tooling only. Alternate tools may adversely affect performance of our connectors along with UL and CSA recognition

4 - Voltage capability of SBE® housings is identical to SBX® but derated to meet EN1175-1 requirements

* Refer to assembly instructions for using 300 MCM and 350 MCM wire

SBE® 320 / SBX® 350 ACCESSORIES

Cable Clamps

Durable metal clamps adapt to a wide range of cable sizes. Cable clamp kit includes clamp top and bottom as well as the hardware bag.

Description	Cable Size		Part Number
	Min / Max Inches O.D.	Min / Max mm O.D.	
Minimum Quantity			25
Cable Clamp Kit	0.85 to 0.67	21.6 to 17.1	911G2

The given wire O.D. information is an estimate. Cable clamps should be evaluated for performance with the actual wire to be used.

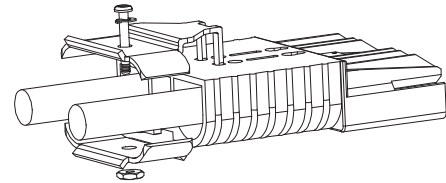

Handles *

Handles are made out of durable PC plastic. Hardware to attach to connector body included in kits.

Description	Part Numbers	
Minimum Quantity	100	25
Gray Handle Kit	-	995G2
Red Handle Kit	-	995G4
Handle Only, Gray	3-5074P1	-
Handle Only, Red	3-5074P3	-
Handle Only, Black	3-5074P5	-
Hardware Bag	-	106G7

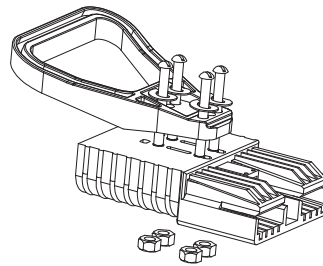

* Torque value 50 (in - lbs) / 5.6 (Nm)

NOTE: For assembly of clamps to housing only

Powerpole® Auxiliary

Powerpole® auxiliary connectors are rated up to 30 amps 600 volts and can be used for auxiliary power, control or sensing. The auxiliary kit includes (1) each black and red standard Powerpole® housing, (2) Contacts, (2) Zip Cable Straps, and (2) Retaining Pins. (1) Retaining Clip can be substituted for (2) Retaining Pins.

Description	Part Numbers	
Minimum Quantity	200	25
Powerpole® Auxiliary Kit 16 to 12 AWG Contact	-	6305G1
Powerpole® Auxiliary Kit 20 to 16 AWG Contact	-	6310G1
Black Powerpole® Housing	1327G6	-
Red Powerpole® Housing	1327	-
16 to 12 AWG Contact	1331	-
20 to 16 AWG Contact	1332	-

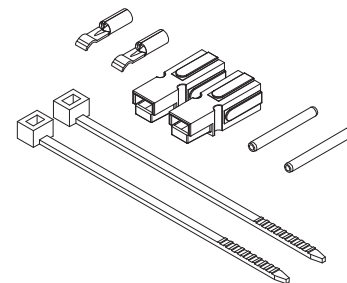

NOTE: Finger proof PP15/45 housings should not be used for auxiliary contacts.

1x4 Auxiliary Connector

The unique 1x4 auxiliary connector allows up to 4 auxiliary circuits up to 20 amps 150 volts each in SBE®, SBO®, & SBX® housings. The genderless design holds two each of the gold plated pin & socket contacts. This innovation allows the very durable and cost effective design of SBE®, O, X connectors to substitute for DIN 43589-1 applications where 4 auxiliary contacts are required. Multiple pin lengths allow the further benefit of sequencing between circuits. (2) Retaining Pins or (1) Retaining Clip is required to hold the auxiliary housing in place. Auxiliary Kits include (1) Auxiliary Housing, (2) Standard Length Pin Contacts, (2) Socket Contacts, (2) Retaining Pins and (1) Retaining Clip.

Description	AWG	mm ²	Part Numbers		
Minimum Quantity			1,000	250	25
1x4 Auxiliary Kit	12	4	-	-	440G3
1x4 Auxiliary Kit	16 to 14	1.5 to 2.5	-	-	440G1
1x4 Auxiliary Kit	20 to 16	0.75 to 1.5	-	-	440G2
1x4 Auxiliary Housing	Contacts Sold Separately		3-5956P1	444G1	-

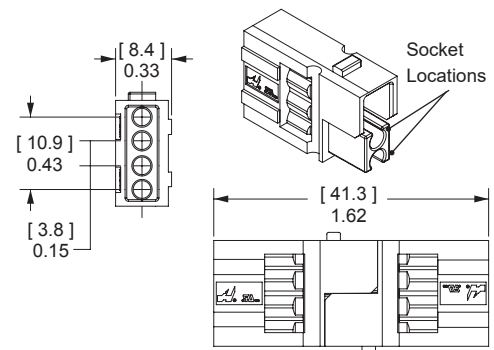

Pin Contacts for 1x4 Auxiliary Connector

Gold plated contacts are available in 4 lengths to allow sequencing of circuits.

Description	AWG	mm ²	Part Numbers	
Minimum Quantity			500	50
Standard Length 7.7 mm	12	2.5	PM16P12S30	PM16P12S30-50
	16 to 14	1.0 to 1.5	PM16P1416S30	PM16P1416S30-50
	20 to 16	0.75 to 1.0	PM16P1620S30	PM16P1620S30-50
	24 to 20	0.50 to 0.75	PM16P2024S30	PM16P2024S30-50
Pre-Mate 9.3 mm	12	2.5	PM16P12A30	PM16P12A30-50
	16 to 14	1.0 to 1.5	PM16P1416A30	PM16P1416A30-50
	20 to 16	0.75 to 1.0	PM16P1620A30	PM16P1620A30-50
	24 to 20	0.50 to 0.75	PM16P2024A30	PM16P2024A30-50
Post-Mate 6.4 mm	12	2.5	PM16P12C30	PM16P12C30-50
	16 to 14	1.0 to 1.5	PM16P1416C30	PM16P1416C30-50
	20 to 16	0.75 to 1.0	PM16P1620C30	PM16P1620C30-50
	24 to 20	0.50 to 0.75	PM16P2024C30	PM16P2024C30-50

Auxiliary Pin Contact Lengths	- L -		- L1 -	
	in.	mm	in.	mm
Standard Length 7.7 mm	0.77	19.6	0.30	7.7
Pre-Mate 9.3 mm	0.83	21.2	0.37	9.3
Post-Mate 6.4 mm	0.72	18.3	0.25	6.4

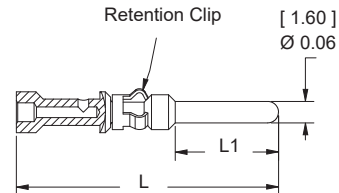

Socket Contacts for 1x4 Auxiliary Connector

Selectively gold plated contacts offer low resistance and durability up to 10,000 mating cycles.

Description	AWG	mm ²	Part Numbers	
Minimum Quantity			500	50
Socket Contact	12	2.5	PM16S12S32	PM16S12S32-50
	16 to 14	1.0 to 1.5	PM16S1416S32	PM16S1416S32-50
	20 to 16	0.75 to 1.0	PM16S1620S32	PM16S1620S32-50
	24 to 20	0.50 to 0.75	PM16S2024S32	PM16S2024S32-50

Auxiliary Socket Contacts Crimp Barrel ID		
Wire Gauge	in.	mm.
24 to 20	0.04	1.1
20 to 16	0.07	1.7
16 to 14	0.08	2.1
12	0.10	2.6

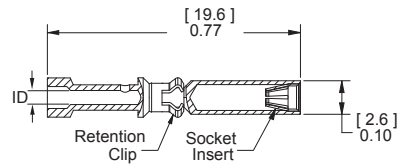

SBE® Air Tubes

Air tubes fit into SBE® housings to allow electrolyte circulation while charging the battery. Genderless tube design allows the same part to be used on both sides. (2) Retaining Pins or (2) Spirol pins are required to hold the air tube in place both are included in Air Tube Kit.

Description	Part Numbers	
Minimum Quantity	500	25
Air Tube Kit, Black	-	6396G1
Air Tube Only	3-5798P1	-

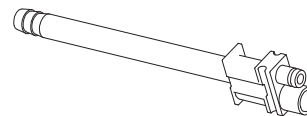

PPMX Auxiliary Connector

The PPMX auxiliary connector allows up to 8 auxiliary circuits to be used in the SBE®, SBO®, & SBX® housings. There are 4 auxiliary circuits per PPMX connector and two PPMX housings fit into the auxiliary port in the main connector housing. Rated up to 7 amps 300 volts per contact, the genderless design holds two each gold plated pin & socket contacts. This innovation allows the very durable and cost effective design of SBE®, O, X connectors to be used for applications requiring up to 8 battery monitoring or equipment vehicle communication circuits. (2) Retaining Pins or (1) Retaining Clip is required to hold the auxiliary housing in place.

Auxiliary Kits includes: (1) Auxiliary Housing, (2) Pin Contacts, and (2) Socket Contacts.

Description	AWG	mm ²	Part Numbers		
Minimum Quantity			1,000	100	25
PPMX Auxiliary Kit	24 to 20	0.50 to 0.25	-	4850G6	-
1x4 Auxiliary Housing	Contacts Sold Separately		4827G6-BK	-	4827G6

* No extraction tool required for contact removal.

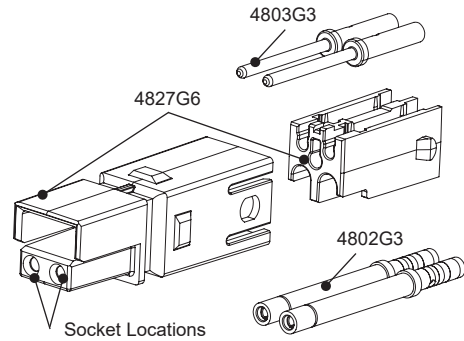

Pin & Socket Contacts for PPMX Auxiliary Connector

Gold plated contacts are ideal for signal or low power use with durability up to 5,000 mating cycles.

Description	AWG	mm ²	Part Numbers	
Minimum Quantity			2,000	50
Pin Contacts	24 to 20	0.50 to 0.25	4803G3-BK	4803G3
Socket Contacts	24 to 20	0.50 to 0.25	4802G3-BK	4802G3

Retaining Clip

Retaining clips can be used in place of two retaining pins to hold auxiliary connectors or air tubes. Allows easier removal of auxiliary modules.

Description	Part Number
Minimum Quantity	100
For SBE® 320 & SBX® 350	2-8675P1

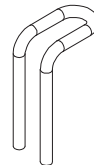

Retaining Pins

Retaining pins are used to hold accessories in the auxiliary port in SBE®, SBO®, & SBX® housings. Dimension "B" is +/- 0.015 in or 0.38 mm.

Description	Part Number	Dimensions			
		- A -		- B -	
		inches	mm	inches	mm
Minimum Quantity	1,000				
For SBE® 320 & SBX® 350	110G59-BK	0.093 / 0.103	2.36 / 2.62	1.000	25.40

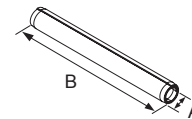

Zip Cable Straps

Zip cable straps are used to secure auxiliary wires to the side of the main power cables.

Use cable ties to secure auxiliary contact leads to one of the main cables.

Description	Part Number
Minimum Quantity	1,000
White	H1835P3

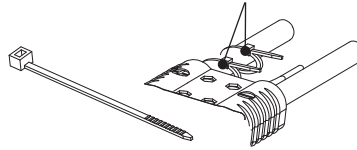

Manual Release - Battery Side *

Works with the Charger / Truck side to ease mating and unmating connectors.

Description	Part Numbers
Minimum Quantity	72 25
Bracket and Hardware Kit	- 993G1
Battery Bracket Only	111961P1 -
Hardware Bag	- 106G6

* Torque value 50 (in - lbs) / 5.6 (Nm)

NOTE: For assembly of bracket to housing only

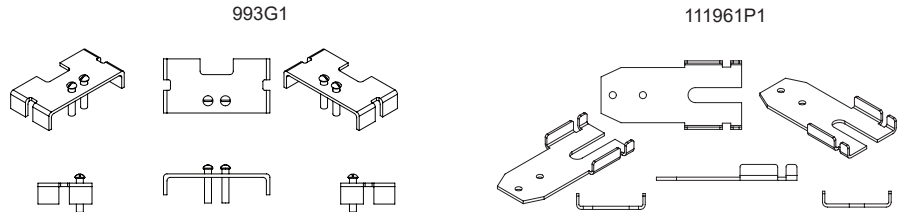

Manual Release - Charger/ Truck Side *

Works with the Battery side to ease mating and unmating connectors.

Description	Part Numbers
Minimum Quantity	25
Bracket and Hardware Kit	994G1
Bracket / Lever Only	B00511G4
Hardware Bag	106G6

* Torque value 50 (in lbs) / 5.6 (Nm)

NOTE: For assembly of bracket to housing only

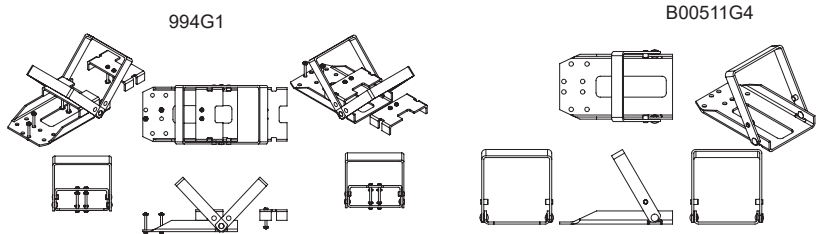

Reducing Bushings: for Use with Contact Part Number 6354 and Bushing Part Number 5918

Use with contact part number 6354-BK and bushing part number 5918-BK to allow a smaller wire to be use with the connector. Electrical capability is derated with smaller wire.

Bushings Part Number 5918		Part Numbers				Dimensions	
Barrel Size	Wire Size					- ID -	
AWG mm²	AWG mm²	1,500	1,000	500	100	inches	mm
Minimum Quantity							
1/0 53.5	1 42.4	-	-	5687-BK	5687	0.39	9.91
1/0 53.5	2 33.6	5690-BK	-	-	5690	0.34	8.64
1/0 53.5	4 21.2	-	5693-BK	-	5693	0.27	6.86
1/0 53.5	6 13.3	-	5663-BK	-	5663	0.22	5.59
1/0 53.5	10 to 8 5.3 to 8.4	5648-BK	-	-	5648	0.19	4.83

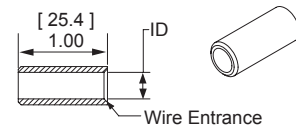

Charger Key

Prevents charger and truck connector halves from engaging.

Description	Part Numbers	For Use With	Hardware Kit Includes
Minimum Quantity	25		
Charger Key Kit	6337G1	SBX®175/SBX®350 Connectors	1 Yellow Key 2 Retaining Pins

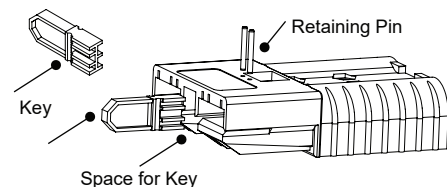

Silver Plated Reducing Bushings: for Use with Contact Part Number 6354

Use with contact part number 6354-BK to allow a smaller wire to be used with the connector. Electrical capability is derated with smaller wire.

Contact Barrel Size / Wire Size	Part Number	
Minimum Quantity	500	100
2/0 AWG (67.4 mm ²) 1/0 AWG (53.5 mm ²)	5918-BK	5918

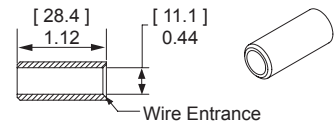

Silver Plated Reducing Bushings: for Use with Contact Part Number 6394

Use with contact part number 6394-BK to allow a smaller wire to be used with the connector. Electrical capability is derated with smaller wire.

Contact Barrel Size / Wire Size	Part Numbers		Dimensions - ID -	
Minimum Quantity			inches	mm
35 mm ²	16 mm ²	5920-BK 5920	0.23	5.8

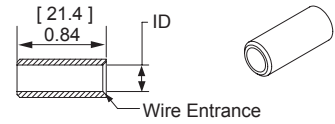

Double Stacked Manual Assist Brackets

The robust frames ensure connector alignment and provide the ability to mount the truck/charger bracket assembly. The brackets include an ergonomic handle that reduces the operator effort required for mating and unmating the connectors. This ensures complete engagement of mated pairs reducing the possibility of shorts or disconnects.

Part Numbers	Safety Agency Ratings
--------------	-----------------------

993G5 – SBE@320 & SBX@350 Double Stack Battery Bracket	*SBE@320 & SBX@350 – UL 700 amps / CSA 450 amps
994G5 – SBE@320 & SBX@350 Double Stack Truck Charger Bracket	*SBE@320 & SBX@350 – UL 700 amps / CSA 450 amps

* Ratings with four connectors assembled using Double Stack Brackets and 4/0 wire

