

LOC	DIST	REV	DATE	BY	APPD
-	-	C	3-2-11	CT	DH

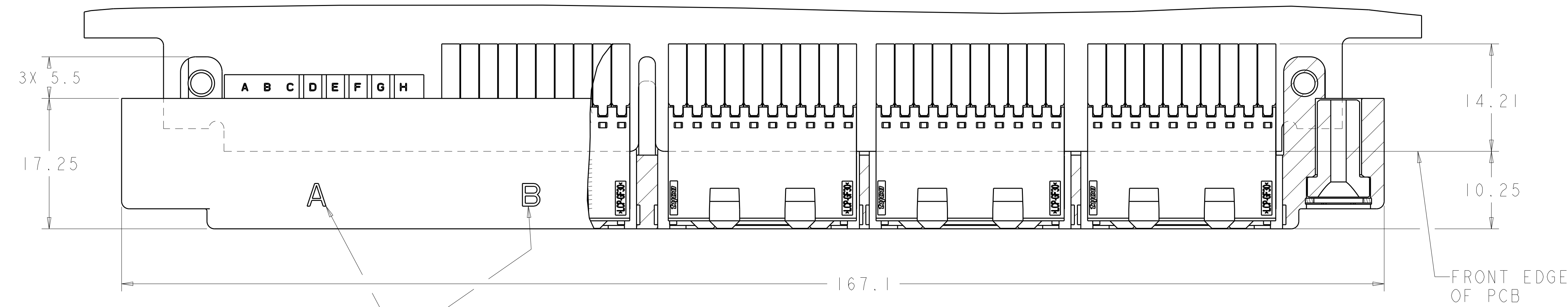

SHELL POCKET IDENTIFIER

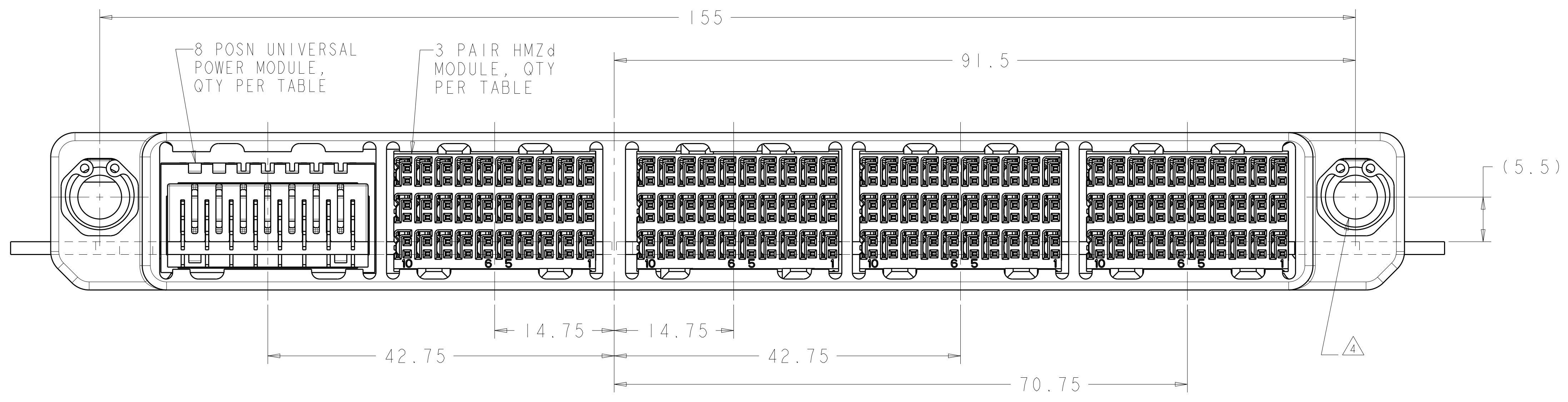

(2.25) SHELL ALIGNMENT FEATURE

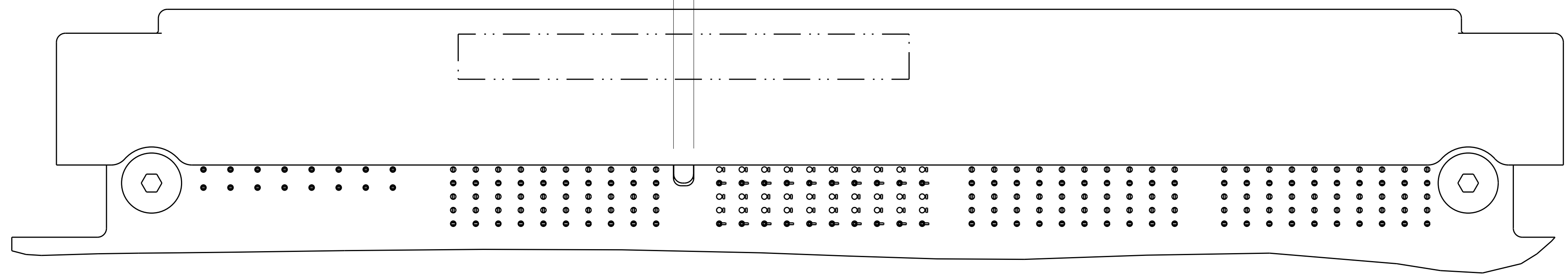

NOT RELEASED	---	1	---	3	---	2000834-4
		1		4		2000834-3
NOT RELEASED	---	2	---	2	---	2000834-2
		-		5		2000834-1
	8 POSN RF COAX	8 POSN UPM	3 PAIR HMZd			PART NUMBER
	MODULE QTY PER ASSY					

- MATING CONNECTOR FOR THIS CONNECTOR IS 2000835.
- MATERIAL- SHELL: ALUMINUM
 HOUSING: GLASS FILLED POLYESTER, UL94V0
 RETAINING RING: STAINLESS STEEL
 KEYING GUIDE SOCKET: STAINLESS STEEL
- PLATING- CONTACT MATING AREA: 1.27µm MIN GOLD OVER 1.27µm MIN NICKEL
 CONTACT PCB AREA: 0.5µm MIN BRIGHT TIN-LEAD OVER 1.27µm MIN NICKEL
 SHELL: ELECTROLESS NICKEL
- KEYING GUIDE SOCKET AND RETAINING RING PACKAGED FOR ASSEMBLY BY CUSTOMER.

<small>THIS DRAWING IS UNPUBLISHED. RELEASED FOR PUBLICATION BY TYCO ELECTRONICS CORPORATION. ALL RIGHTS RESERVED.</small>		DWN: Brent D. Yohn CHK: CHONG YI APVD: M. R. McALONIS	Tyco Electronics Harrisburg, PA 17105-3608
DIMENSIONS: mm TOLERANCES UNLESS OTHERWISE SPECIFIED: 0 PLC ±.1 1 PLC ±.1 2 PLC ±.1 3 PLC ±.1 4 PLC ±.1 ANGLES ±.1	DATE: 13JAN2010 NAME: M. R. McALONIS PRODUCT SPEC: 108-2381 APPLICATION SPEC:	Tyco Electronics DAUGHTER CARD CONNECTOR, HIGH SPEED RUGGEDIZED (HSR), 5 BAY, UNSEALED, RIGHT ANGLE	SIZE: A11 CAGE CODE: 00779 DRAWING NO: 2000834
MATERIAL: 2	FINISH: 3	WEIGHT: -	SCALE: 3:1 SHEET 1 OF 2 REV C
CUSTOMER DRAWING		RESTRICTED TO	

LOC	DIST	REV	DATE	BY	APPD
		1			

REVISIONS		DATE	BY	APPD
1	SEE SHEET 1			

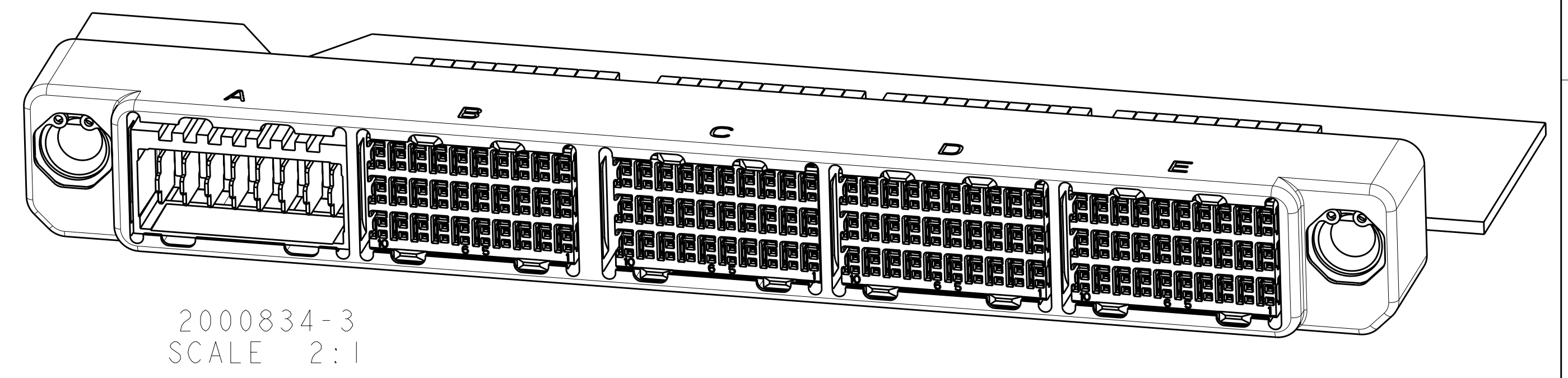
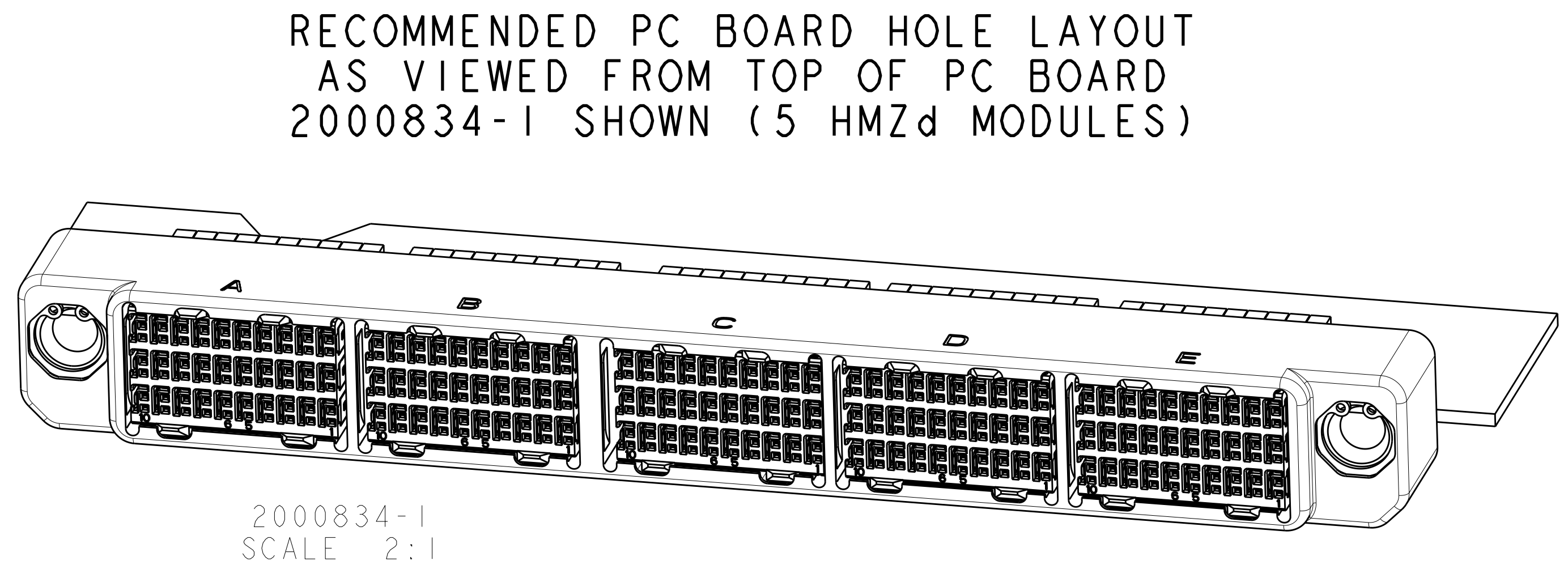
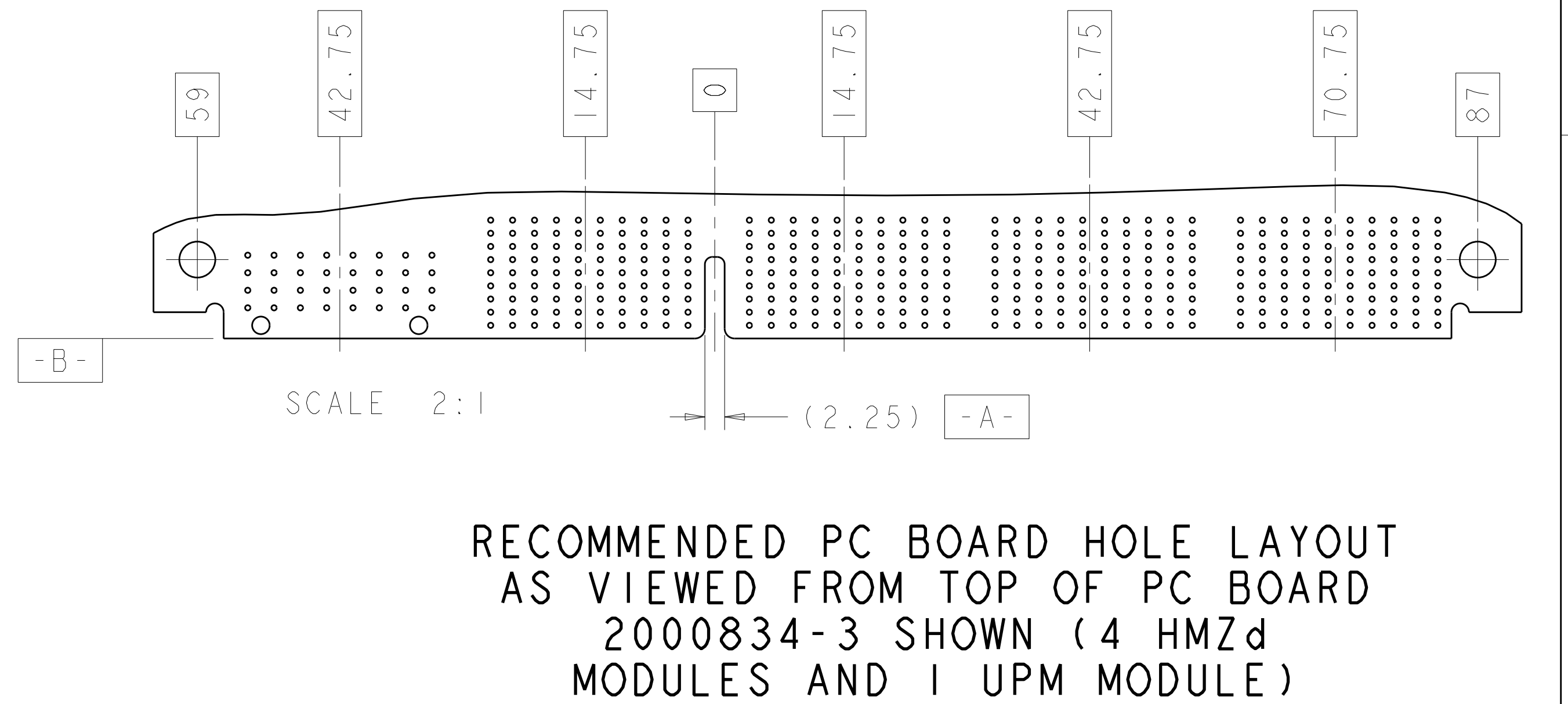
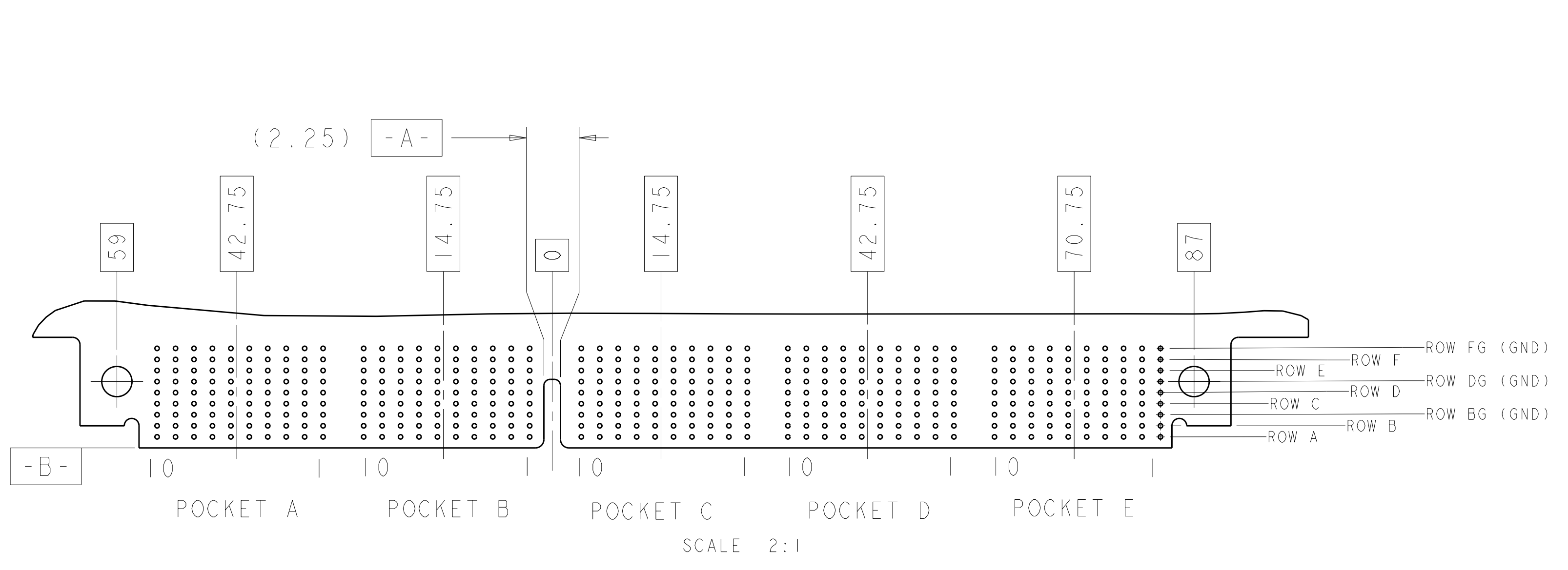
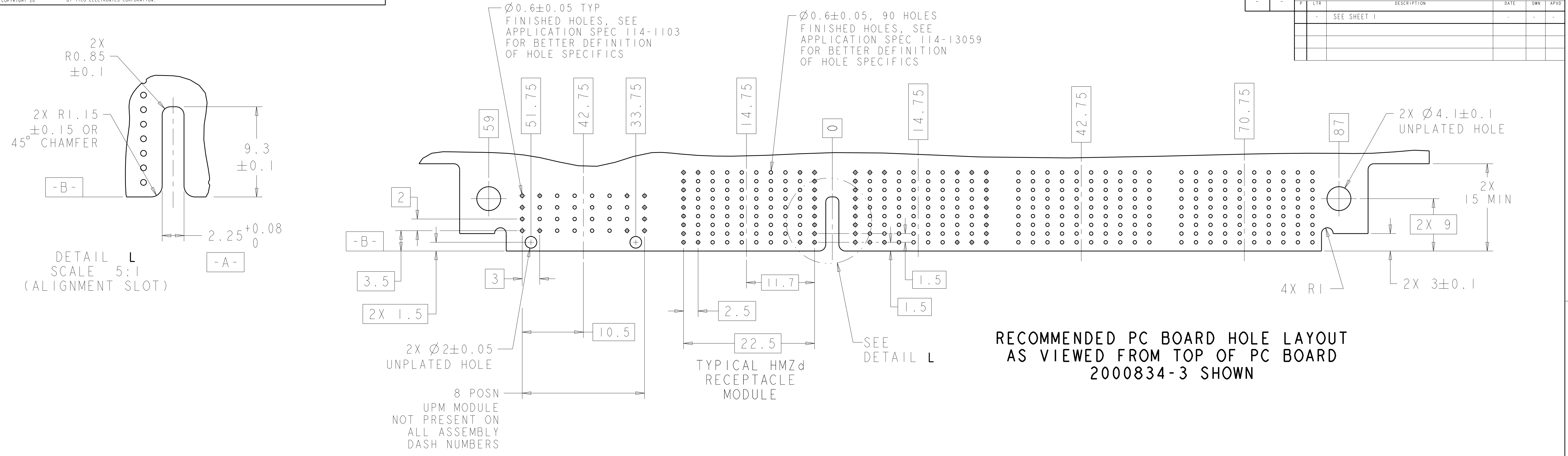

<small>THIS DRAWING IS UNPUBLISHED. RELEASED FOR PUBLICATION. IT IS SUBJECT TO CHANGE WITHOUT NOTICE AND WITHOUT OBLIGATION. TOLERANCES UNLESS OTHERWISE SPECIFIED:</small>		DWN: Brent D. Yohn CHK: CHONG YI APVD: M. R. McALONIS	DATE: 13JAN2010 DATE: 13JAN2010 DATE: 13JAN2010	Tyco Electronics Harrisburg, PA 17105-3608
DIMENSIONS: mm TOLERANCES UNLESS OTHERWISE SPECIFIED: 9 PLC ±.1 1 PLC ±.1 5 PLC ±.1 4 PLC ±.1 ANGLES ±.1 FINISH	PRODUCT SPEC: 108-2381 APPLICATION SPEC:	NAME: M. R. McALONIS SIZE: A11 CAGE CODE: 00779 DRAWING NO: 2000834	DAUGHTER CARD CONNECTOR, HIGH SPEED RUGGEDIZED (HSR), 5 BAY, UNSEALED, RIGHT ANGLE	RESTRICTED TO:
MATERIAL:	FINISH:	WEIGHT:	CUSTOMER DRAWING:	SCALE: 3:1 SHEET 2 OF 2 REV C