

## 830M1 TRIAXIAL CONDITION MONITORING ACCELEROMETER

- Triaxial Piezoelectric Accelerometer
- $\pm 25\text{g}$  to  $\pm 2000\text{g}$  Dynamic Ranges
- Wide Bandwidth to 15,000Hz
- Superior Resolution to MEMS Devices
- Circuit Board Mountable, Reflow Solderable
- Low Cost, Superior Value

The Model 830M1 is a low cost, triaxial board mountable accelerometer designed for embedded condition monitoring and preventive maintenance applications. The piezoelectric (PE) accelerometer is available in ranges from  $\pm 25\text{g}$  to  $\pm 2000\text{g}$  and features a flat frequency response up to  $>15\text{kHz}$  in all three axes. The model 830M1 accelerometer three independent stable piezo-ceramic crystals in shear mode with low power electronics, sealed in a fully hermetic LCC package.

The PE technology incorporated in the 830M1 accelerometer has a proven track record for offering the reliable and long-term stable output required for condition monitoring applications. The accelerometer is designed and qualified for machine health monitoring and has superior resolution, dynamic range and bandwidth compared to MEMS devices.

An RTD temperature sensor is included inside the LCC package should the intended application require both a vibration and temperature sensor signal.

For single axis measurements, TE Connectivity also offers other accelerometer models with the same outstanding performance specifications.

### FEATURES

- Temperature Sensor Included
- Amplified  $\pm 1.25\text{V}$  Signal Output
- 3.3 to 5.5Vdc Excitation Voltage
- Hermetically Sealed LCC Package
- Piezo-Ceramic Crystals, Shear Mode
- $-40^\circ$  to  $+125^\circ\text{C}$  Operating Range
- Small PCB Footprint

### APPLICATIONS

- Machine Health Monitoring
- Predictive Maintenance Installations
- Embedded Vibration Monitoring
- Impact & Shock Monitoring
- Data Loggers
- Bearing Installations
- Security Monitoring

[CLICK HERE >](#)  
**CONNECT WITH A SPECIALIST**

## 830M1 TRIAXIAL ACCELEROMETER

### ABSOLUTE MAXIMUM RATINGS <sup>(1)</sup>

Parameter	Symbol	Min	Typ	Max	Unit	Notes/Conditions
Supply voltage <sup>(2)</sup>	V <sub>dd</sub>	1.5	3.3	5.5	V	
Storage temperature	T <sub>s</sub>	-40		125	°C	
Shock limit (any axis)	g <sub>max</sub>			5,000	g	
ESD		-2		+2	kV	Human body model

<sup>(1)</sup> Maximum limits the device will withstand without damage

<sup>(2)</sup> With 1.5V-2.5V excitation, full-scale range will be limited. So 3.3V min recommended.

### OPERATING RANGES & NOISE - ACCELEROMETER

(Unless otherwise specified, all parameters are measured at 24°C @ 3.3V applied)

Measurement Range (g)	Sensitivity mV/g	Non-Linearity (%FSO)	Residual Noise <sup>(1)</sup> (mg RMS)	Spectral Noise (mg/√Hz)			
				10Hz	100Hz	1kHz	10kHz
±25	50.0	±2	2.9	0.15	0.07	0.03	0.02
±50	25.0	±2	5.9	0.29	0.13	0.05	0.05
±100	12.5	±2	11.7	0.58	0.27	0.09	0.09
±200	6.3	±2	23.2	1.16	0.53	0.18	0.18
±500	2.50	±2	58.5	2.92	1.34	0.52	0.45
±1000	1.25	±2	117	5.84	2.68	1.04	0.90
±2000	0.63	±2	234	11.7	5.36	2.08	1.80

<sup>(1)</sup> 2Hz to 10 kHz

### ELECTRICAL SPECIFICATIONS

(Unless otherwise specified, all parameters are measured at 24°C @ 3.3V applied)

Parameters	Symbol	Min	Typ	Max	Unit	Notes/Conditions
Excitation voltage	V <sub>dd</sub>	3.3		5.5	Vdc	
Zero g output voltage			V <sub>dd</sub> /2			50% of applied voltage
Average supply current	I <sub>avg</sub>		200		µA	
Output impedance	R <sub>out</sub>			100	Ω	
Warm-up time				1	Sec	

### OPERATING SPECIFICATIONS - ACCELEROMETER

(Unless otherwise specified, all parameters are measured at 24°C @ 3.3V applied)

Parameter	Symbol	Min	Typ	Max	Unit	Notes/Conditions
Full scale output			±1.25		V	
0.0g output voltage (bias V)			V <sub>dd</sub> /2			
Frequency response		6		10k	Hz	±1db
Frequency response		2		15k	Hz	±3db
Resonant frequency		30k			Hz	
Transverse sensitivity				8	%	All Axes
Calibration		CS-SENS-0100 NIST Traceable Amplitude Calibration at 80Hz All parts are shipped with calibration data				

## 830M1 TRIAXIAL ACCELEROMETER

### OPERATING SPECIFICATIONS – RTD TEMPERATURE SENSOR <sup>(1)</sup>

(Unless otherwise specified, all parameters are measured at 0°C)

Parameter	Symbol	Min	Typ	Max	Unit	Notes/Conditions
RTD resistance	R <sub>0</sub>	997.81	1000	1002.20	Ω	@ 0°C
Tolerance		-0.12		+0.12	%	Class B
Calculated tolerance		$\pm(0.4+0.007 \times  T )$			°C	0 to +125°C
		$\pm(0.4+0.028 \times  T )$			°C	-40 to 0°C
Temperature coefficient	TCR	6100	6178	6240	ppm/K	
Temperature range		-40		125	°C	
Self-Heating coefficient <sup>(2)</sup>	EK	1.4	1.7	2.0	mW/K	@ 0°C
Long term stability	ΔR		±0.1		%	1k hrs @ 150°C
Measurement current <sup>(2)</sup>	I		0.2	5	mA	

<sup>(1)</sup>The temperature sensor is located inside the sensor enclosure. As such, it provides the temperature of the sensor interior, not the ambient temperature around the sensor, nor the temperature of surface to which the sensor is mounted.

<sup>(2)</sup>Self heating effects must be taken into account. See additional information in this data sheet.

### ENVIRONMENTAL SPECIFICATIONS

Parameter	Symbol	Min	Typ	Max	Unit	Notes/Conditions
Operating temperature		-40		125	°C	
Storage temperature		-40		125	°C	
Ambient humidity		0		100	%	
Ingress protection	IP	68				Hermetic Package
Media compatibility				External exposed surfaces: Alumina Gold Au/Sn Solder		
Weight			3.3		grams	

# 830M1 TRIAXIAL ACCELEROMETER

## BLOCK DIAGRAM

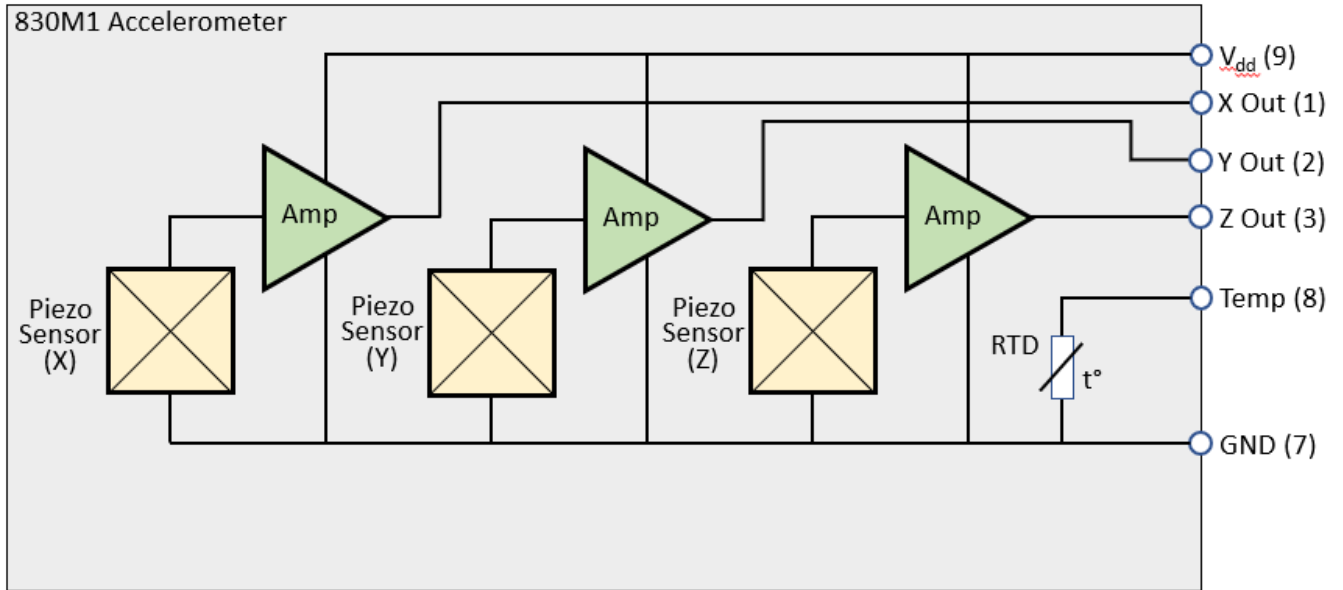

## IR REFLOW TEMPERATURE PROFILE

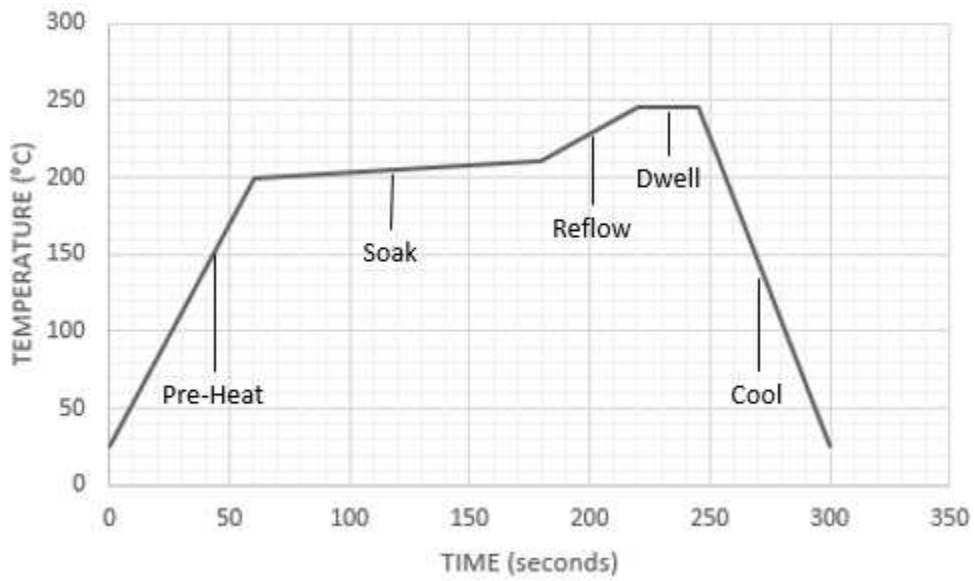

# 830M1 TRIAXIAL ACCELEROMETER

## DIMENSIONS

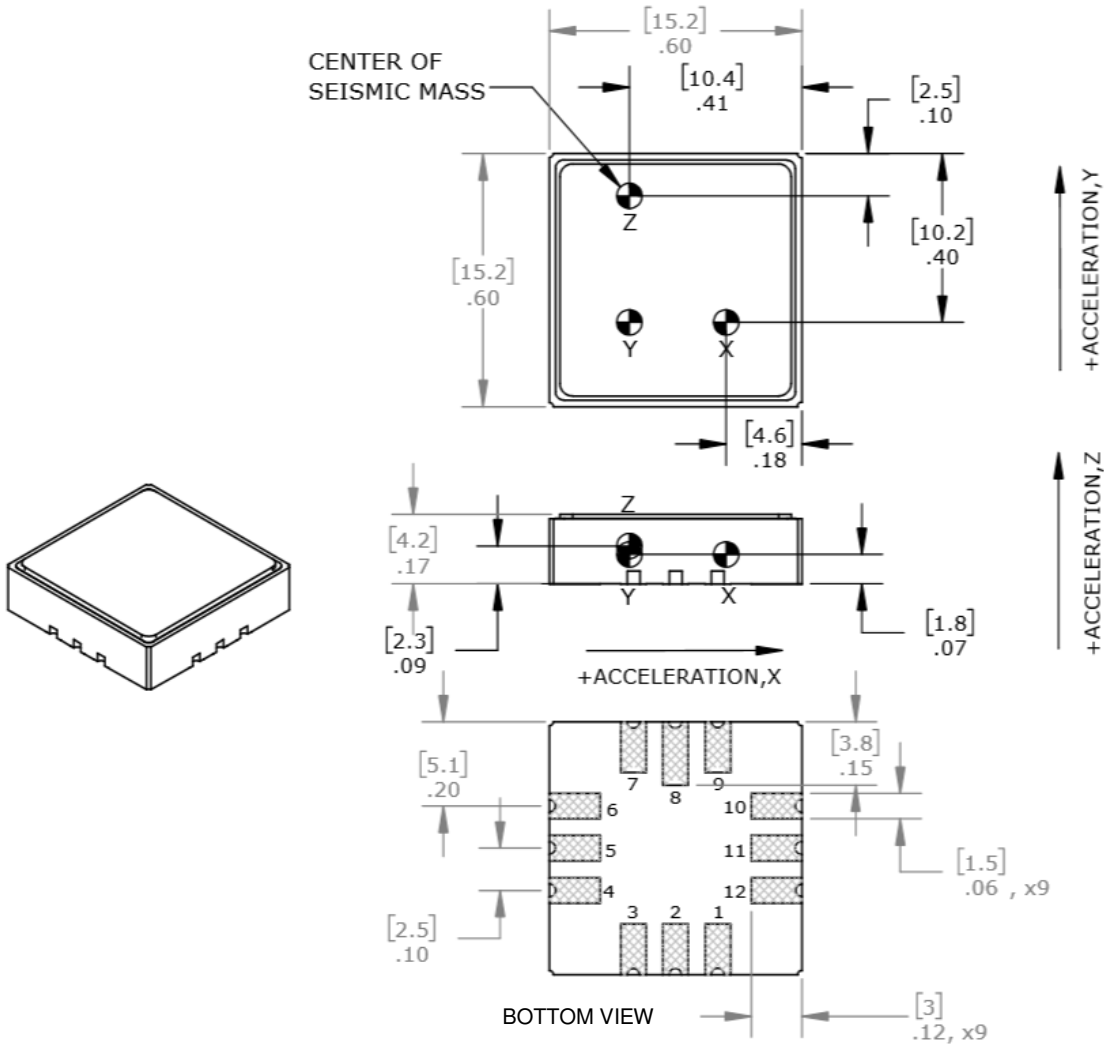

## CONNECTION TABLE

Pin Number	Definition
1	X axis output
2	Y axis output
3	Z axis output
4	N/C
5	N/C
6	N/C
7	GND
8	RTD temp out
9	V <sub>dd</sub>
10	N/C
11	N/C
12	N/C

N/C connections – do not connect to the circuit

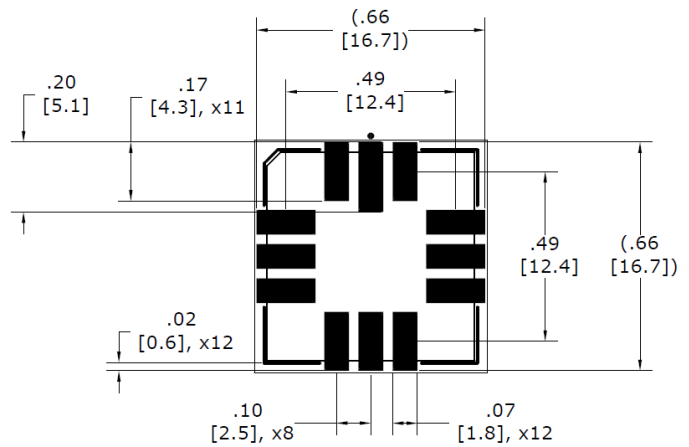

PC board solder pad layout and dimensions

## 830M1 TRIAXIAL ACCELEROMETER

### TYPICAL ACCELEROMETER FREQUENCY RESPONSE CURVE

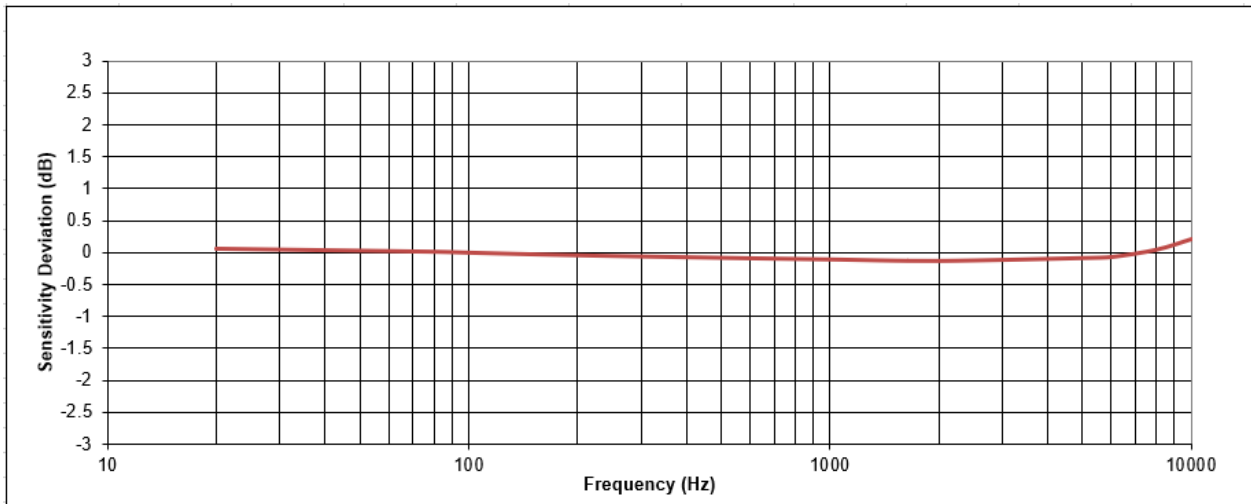

Graph 1

### TYPICAL ACCELEROMETER THERMAL SHIFT OF SENSITIVITY

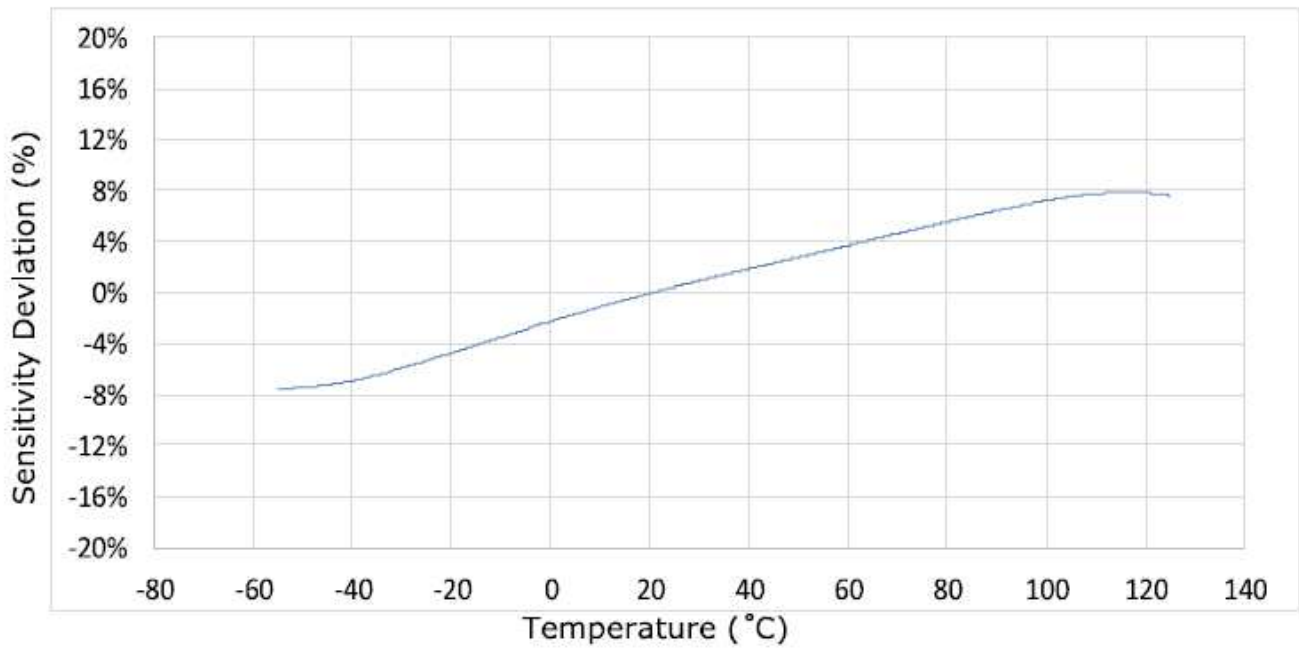

Graph 2

## MOUNTING CONSIDERATIONS

Accelerometers are used to measure vibration and motion of various pieces of equipment and their components. To obtain the most faithful reproduction of the movements, a solid mounting method is required. The model 830M1 is designed to surface mount on a PC board with the primary attachment being the connection solder pads. Although it is recommended that several of the contacts (pins 4-6 & 10-12) not be connected to any part of the electrical circuit, mating solder pads can be added to the PC board but then left unconnected. Soldering all contacts of the accelerometer will provide the most solid mounting and best measurement results.

Rigid support for the accelerometer PC board will also help to improve the quality of measurement signals. Ultimately, the accelerometer must move at the same frequencies and displacements as the object of interest. PC board mounting that's not rigid enough will introduce unwanted noise and resonant frequencies into the measurement signal.

Figure 1 shows an example of a poorly mounted accelerometer. With no support close to the sensor, the PC board will flex and vibrate at its own resonant frequency much like a trampoline. This will introduce unwanted resonant peaks into the frequency range of interest making accurate data collection difficult.

Figure 2 shows a better mounting design that provides support very close to the sensor and helps to eliminate unwanted vibrations and noise. If the PC board is mounted on standoffs, locate at least two standoffs as close to the accelerometer as possible. This will help stabilize the accelerometer mounting surface and help to ensure that faithful vibration and motion get transferred to the sensor.

Figure 3 shows the addition of a rigid mounting block directly between the accelerometer PC board and the vibrating object. This design provides good coupling. Use a rigid adhesive on both mating surfaces of the block for good mechanical coupling.

Figure 4 shows the PC board attached directly to the vibration source. Use a rigid adhesive to improve the transmission of high frequency vibrations and acoustic energy. Soft or elastic adhesives (pressure sensitive tapes, RTVs, pliable glues, etc) tend to dampen and absorb higher frequency excitations. Don't use them.

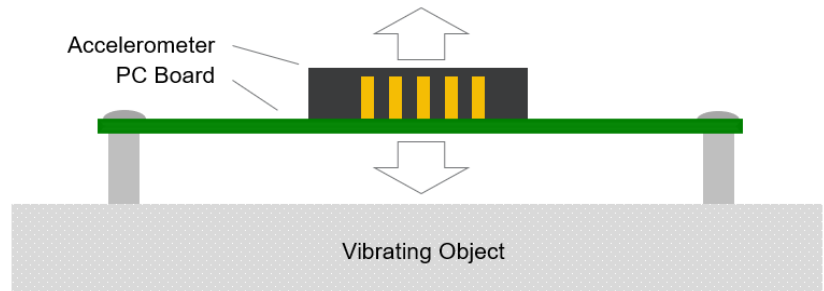

Figure 4

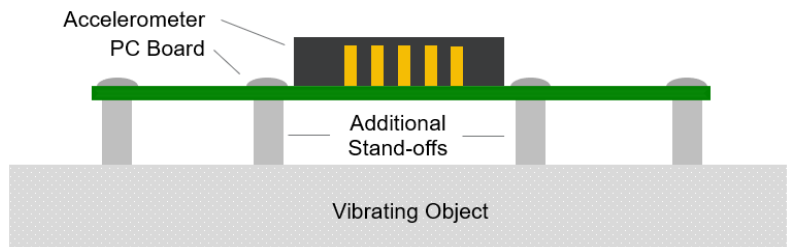

Figure 4

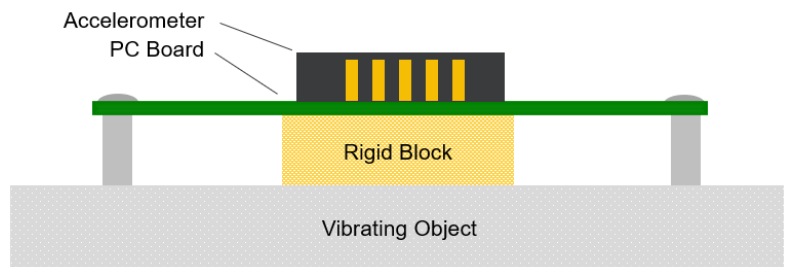

Figure 4

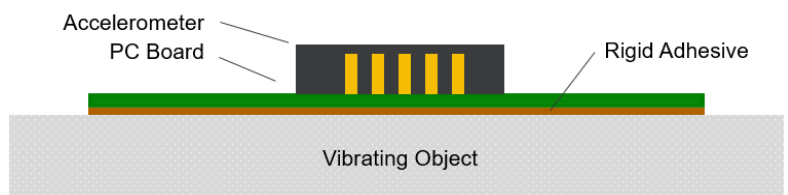

Figure 4

### ORIENTATION CONSIDERATIONS

Accelerometers are designed to do unidirectional motion sensing. A single axis accelerometer will be sensitive to motion and acceleration in a single direction only. The 830M1 is able to sense and measure motion and acceleration in all three orthogonal axes (X, Y, Z) and provides analog voltage outputs that represent the signal magnitude in each axis. The accelerometer must be properly oriented during assembly into the application to ensure that it will accurately sense the magnitude of vibration and motion in the proper axes.

As shown in the detailed dimension drawing, each sensing axis is aligned to be parallel with the external surfaces of the accelerometer package. When the sensor is designed into an application, it's position must be oriented to align with the desired measurement directions of the customer product.

There are many places in an application where alignment errors can appear. The 830M1 is mounted on a PC board and must be carefully aligned to it. The PC board is part of a subsystem and must be carefully aligned there also. And finally, the subsystem is part of the overall product and must be aligned to that. Each of these mounting interfaces can be a source of mis-alignment errors and when summed can become significant.

For the 830M1 accelerometer, there are two types of alignment errors – rotational and tilt. Figures 5 & 6 show how these occur.

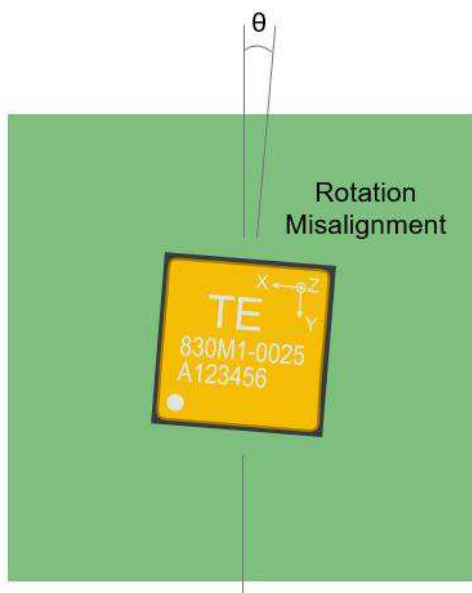

Figure 5



Figure 6

Both types of misalignment errors result in incorrect output voltages for vibration amplitude. The output error will be proportional to the cosine or 1-cosine of the error angle  $\theta$ .

In figure 5, if the acceleration or vibration is along the X axis, a rotational misalignment error will decrease the X axis signal by the cosine of the error angle and increase the Y axis signal by 1-cosine of the error angle. The Z axis signal will not change.

In figure 6, if acceleration is again along the X axis, and the X axis is tilted, then the error will again decrease the X axis signal by the cosine of the error angle and increase the Z axis signal by 1-cosine of the error angle. The Y axis signal will not change.



**ACCELEROMETER OPERATION AT REDUCED VOLTAGES**

The 830M1 accelerometer is designed to provide the specified operation with the applied power voltage in the range of 3.3 to 5.5 VDC. The sensor can also provide limited operation with applied voltages down to 1.5V. The only parameter affected by a reduced input voltage is the maximum output amplitude for each g range.

The internal amplifier is designed to have a constant gain for each g range and will produce a maximum output signal of ±1.25 V for that range. At input voltages less than 2.8 V, the output voltage span will be the same as the power voltage. The sensor will retain the stated sensitivity level, but the output will be clipped at the power supply voltages shown by this formula:

$$g_{max} = g_{spec} \times \frac{V_{app}}{2.5}$$

$g_{max}$  = Measurement g range with applied voltage between 1.5 – 2.5V

$g_{spec}$  = specified g range when applied voltage >2.5V

$V_{app}$  = applied power voltage (1.5 – 2.5V)

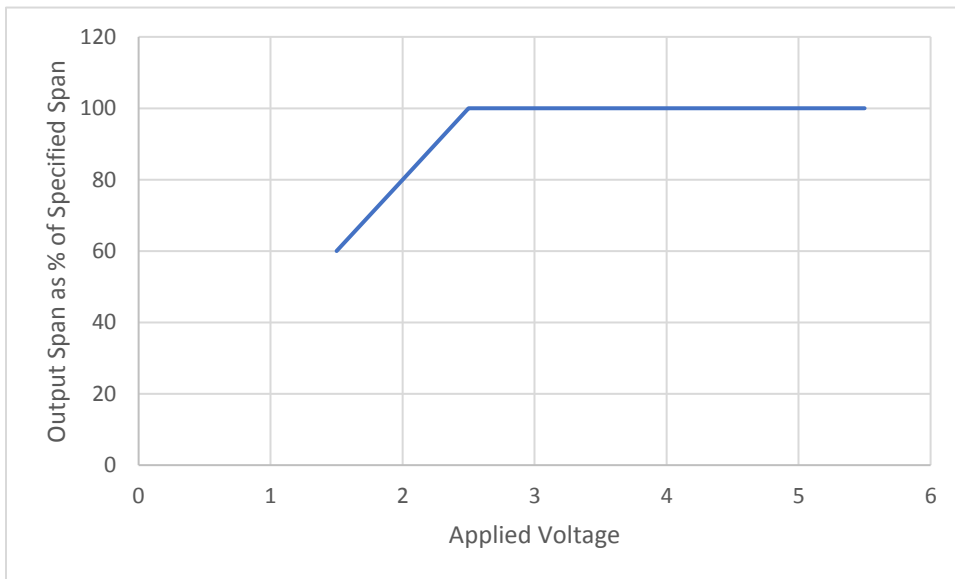
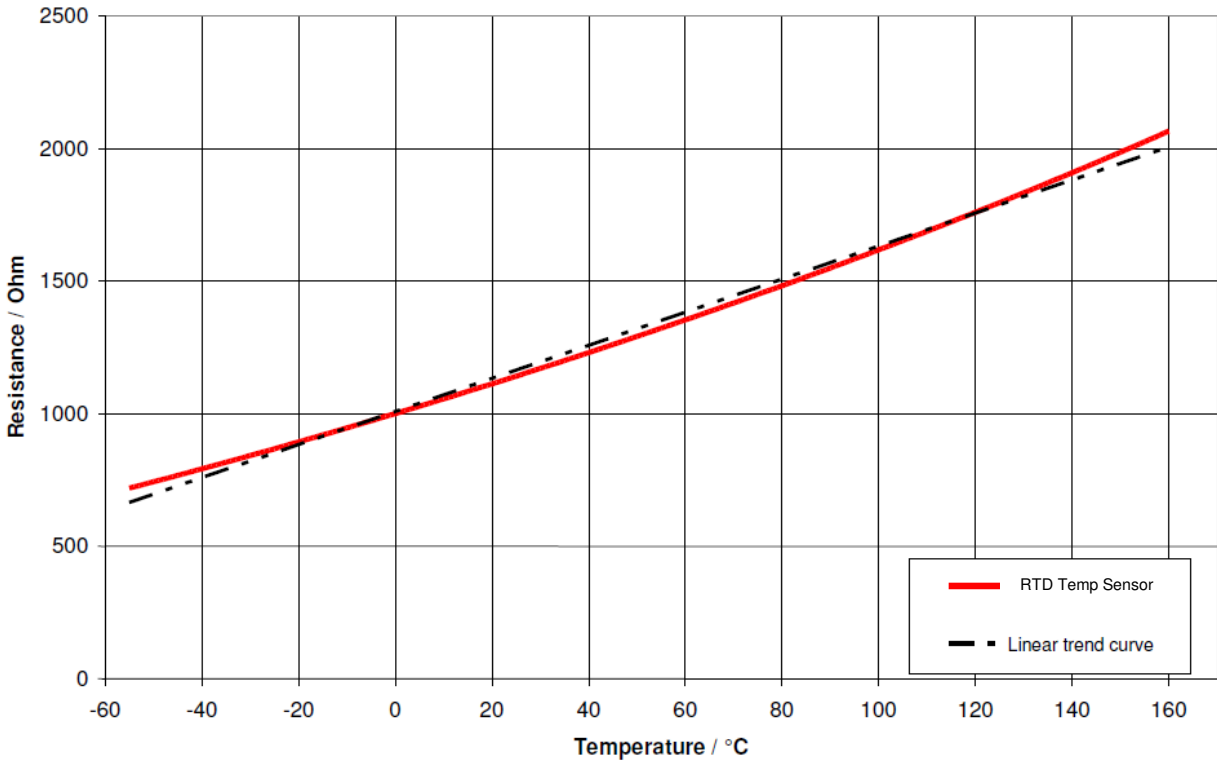

Figure 5

<b>g range (<math>V_{dd} &gt; 2.8V</math>)</b>	<b>Effective g range (<math>V_{dd} = 1.5V</math>)</b>
±25	±15
±50	±30
±100	±60
±200	±120
±500	±300
±1000	±600
±2000	±1200

BUILT-IN RTD TEMPERATURE SENSOR TRANSFER FUNCTION



Graph 3

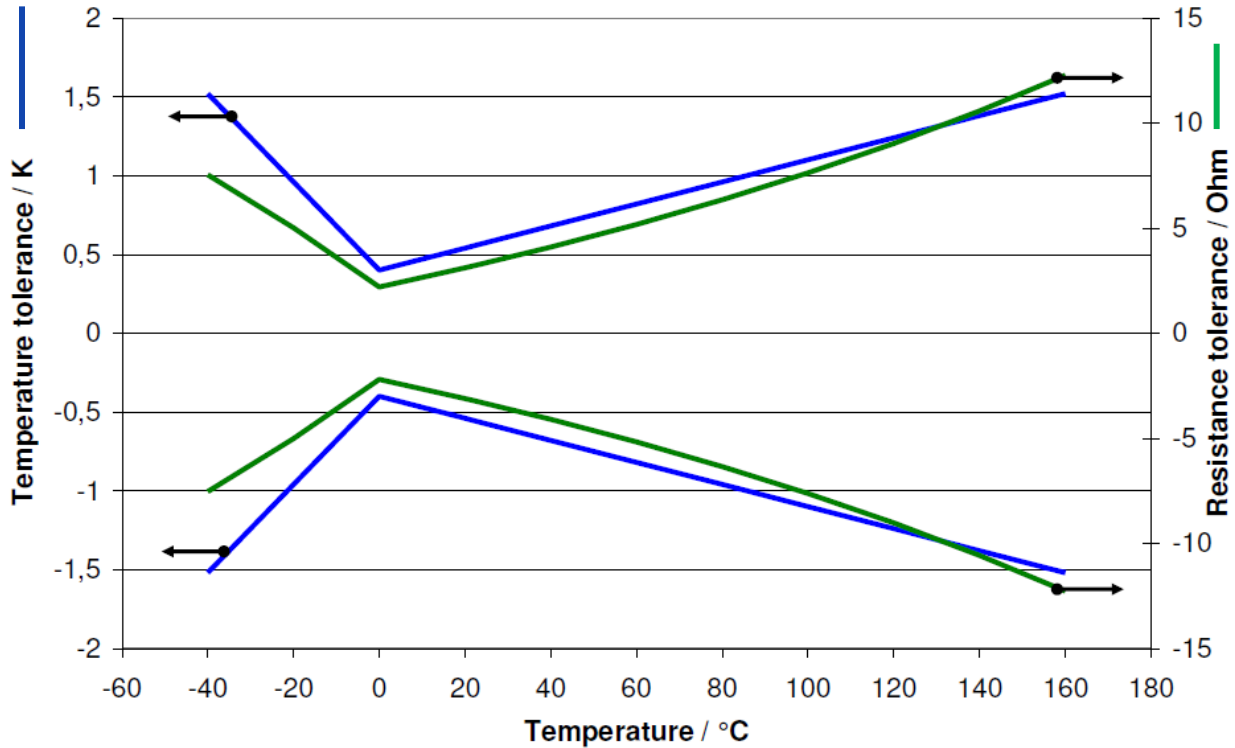

Graph 4

### TEMPERATURE SENSOR SELF HEATING EFFECT

For accurate temperature measurement it is recommended to use a small current to avoid self-heating of the temperature sensing element. The temperature error caused by excessive measurement current can be calculated using:

$$\Delta T = \frac{I^2 \times R}{EK}$$

$\Delta T$  = Sensor output deviation from true temperature  
I = Resistor current  
R = RTD resistance  
EK = Self-heating coefficient

### TEMPERATURE SENSOR ELECTRICAL CHARACTERISTICS

The characteristics of the nickel RTD temperature sensor are specified as per DIN 43760. The large Temperature Coefficient of Resistance (TCR) of the RTD (6178 ppm/K) offers greater sensitivity than other types of RTDs. The electrical characteristics can be described by these equations:

$$R(T) = R_0(1+aT+bT^2+cT^4+dT^6)$$

R = RTD resistance value  
T = Applied temperature  
Coefficients: a =  $5.485 \times 10^{-3}$   
b =  $6.650 \times 10^{-6}$   
c =  $2.805 \times 10^{-11}$   
d =  $-2.000 \times 10^{-17}$

$$T(R) = \underline{a'+b'(1+c'R)^{1/2}}+d'R^5+e'R^7$$

T = True temperature  
R = Measured resistance  
Coefficients: a' = 412.6  
b' = 140.41  
c' = 0.00764  
d' =  $6.25 \times 10^{-17}$   
e' =  $-1.25 \times 10^{-24}$

### TEMPERATURE SENSOR TOLERANCES

Tolerances for the nickel RTD are industry standard class B which is  $\pm 0.12\%$  for resistance at  $0^\circ\text{C}$ . This is equivalent to a temperature accuracy of  $\pm 0.3^\circ\text{C}$ . To calculate tolerance at other temperatures, use these formulae:

$$\text{From } -40^\circ\text{C to } 0^\circ\text{C} - \text{Tolerance} = \pm(0.4+0.028|T|)$$

$$\text{From } 0^\circ\text{C to } 125^\circ\text{C} - \text{Tolerance} = \pm(0.4+0.007|T|)$$

SIMPLE INTERFACE CIRCUITS CONVERT TEMPERATURE TO LINEAR VOLTAGE

The resistive divider or constant current circuits will provide a low accuracy linear voltage output representing temperature.

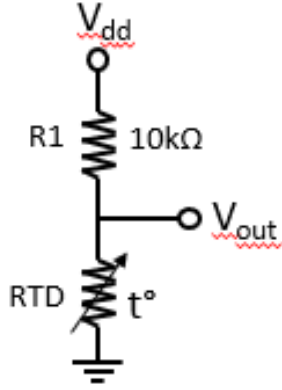

$$V_{out} = \frac{R_{RTD} \times V_{dd}}{(R1 + R_{RTD})}$$

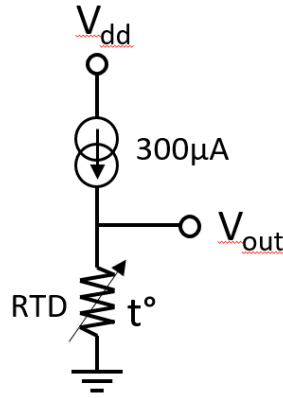

$$V_{out} = R_{RTD} \times I_{cc}$$

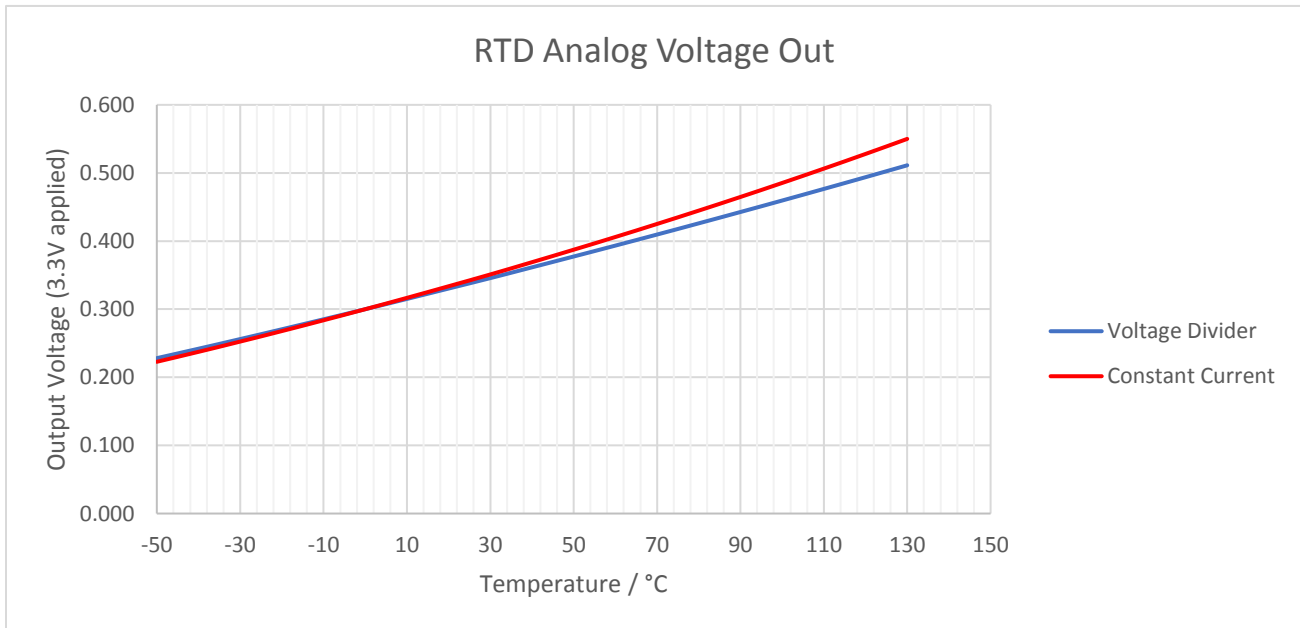

Graph 5

INTERFACE CIRCUIT WITH A HIGH ACCURACY OUTPUT

The operational amplifier circuit uses a Wheatstone bridge front end to improve measurement resolution. The addition of R5 improves the circuit linearity.

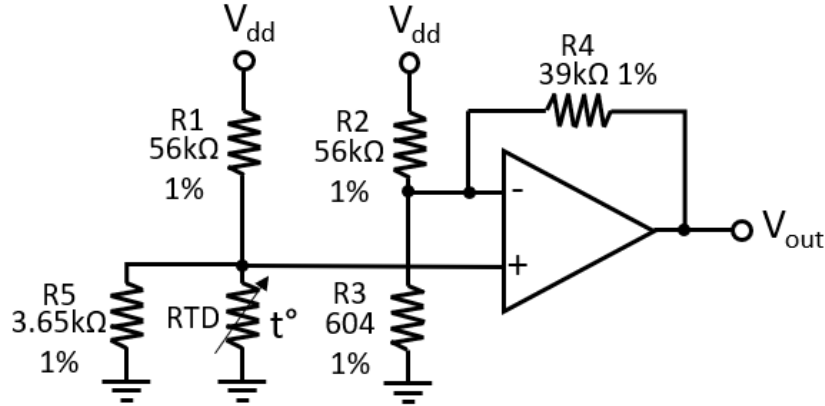

$$V_{out} = \frac{\left[ \frac{R_{RTD} \times R5}{R_{RTD} + R5} \right] \times V_{dd}}{R1 + \left[ \frac{R_{RTD} \times R5}{R_{RTD} + R5} \right]} \times \left[ 1 + R4 \times \left[ \frac{1}{R2} + \frac{1}{R3} \right] \right] - \frac{R4 \times V_{dd}}{R2}$$

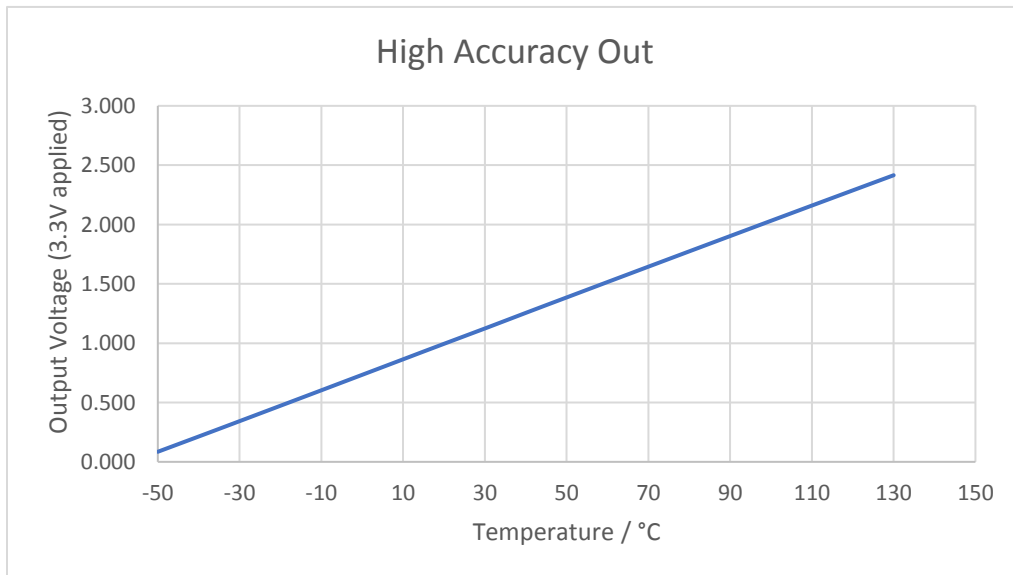

Graph 6

# 830M1 TRIAXIAL ACCELEROMETER

## PACKAGING OPTIONS

Stackable Trays – 50 pcs ea

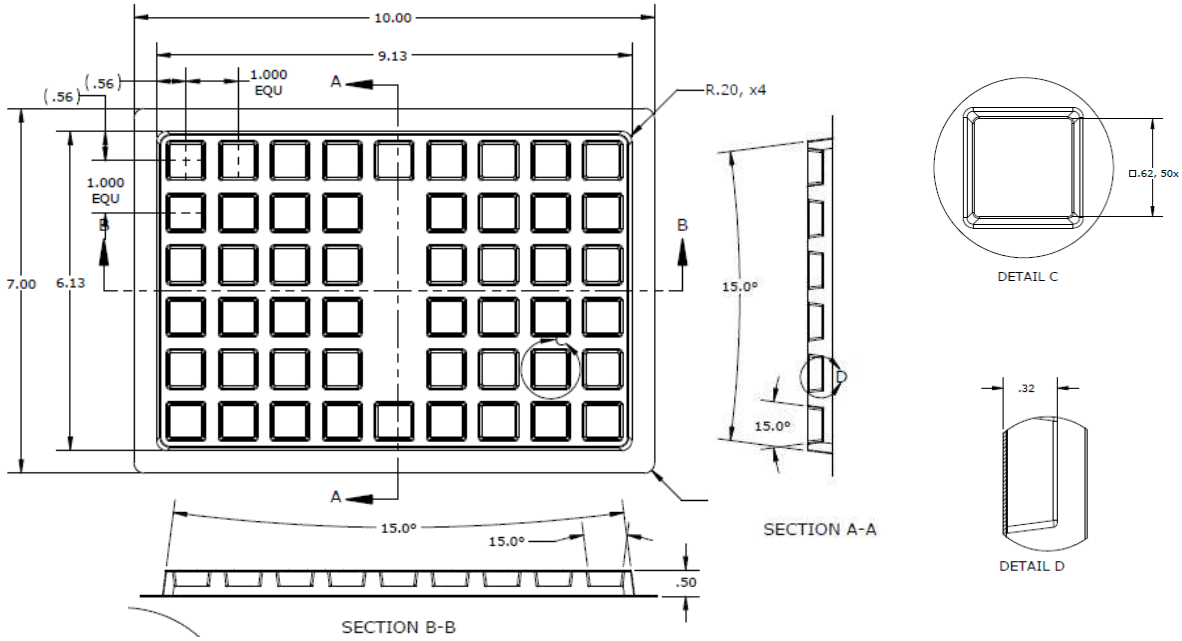

Tape & Reel

