



FEATURES

- Acceleration and temperature output
- Compact design, stud mount
- Up to 5-year battery life
- Low power consumption
- -20°C to +60°C operating temperature
- 30kHz resonant frequency

APPLICATIONS

- Remote condition monitoring
- Reduced installation costs – no cables
- Designed for harsh environments
- Quick and scalable deployment
- Cost effective monitoring for large plants
- Secure and interference free transmission

8911 WIRELESS ACCELEROMETER FOR PROOF OF CONCEPT

LoRaWAN™ 868/915MHz

SPECIFICATIONS

- Wireless Piezoelectric Proof of Concept (POC) Accelerometer for Condition Monitoring
- Programmable, Customer Configurable
- Corrosion Resistant Stainless-Steel & Polymer Housing
- Wide Bandwidth to >10kHz
- Exceptional Long Term Stability
- Superior Measurement Resolution

INTRODUCTION

The TE model 8911 wireless accelerometer for POC combines a sensor, data collector, digital signal processor, and radio into one compact, battery-operated device that measures both vibration and temperature data.

The model 8911 wireless accelerometer uses the LoRaWAN™ communication protocol, offering a simple, reliable and secure means of expanding condition-based maintenance into plant areas where the cost to install wired systems is prohibitive, making data available to existing process control and information systems.

The model 8911 incorporates a piezo-electric accelerometer which offers a wide bandwidth to >10kHz, outstanding measurement resolution and superior long-term stability compared to design using MEMS solutions.

The 8911 contains digital signal processing that provides an FFT analysis of the vibration being sensed. The output data describes the center frequency, peak value, bandwidth, and percent of the total spectral content for the eight most significant acceleration peaks in the vibration signal.

Because of this feature, the 8911 directly provides the data most needed to plot trends and monitor changes in the performance and condition of factory machinery.

[CLICK HERE >](#)
CONNECT WITH A SPECIALIST

*This device has not been authorized as required by the rules of the Federal Communications Commission.

8911 WIRELESS ACCELEROMETER FOR PROOF OF CONCEPT

LoRaWAN™ 868/915MHz

ABSOLUTE MAXIMUM RATINGS⁽¹⁾

Parameter	Symbol	Min	Typ	Max	Unit	Notes/Conditions
Supply voltage	V _{dd}			3.5	V	Replaceable battery
Storage temperature	T _S	-40		120	°C	Without battery
Shock limit	g _{max}			2000	g	
ESD		-2		+2	kV	Human body model

⁽¹⁾ Maximum limits the device will withstand without damage

ELECTRICAL SPECIFICATIONS

(Unless otherwise specified, all parameters are measured at 24°C @ 3.0V applied)

Parameters	Symbol	Min	Typ	Max	Unit	Notes/Conditions
Power Supply	V _{dd}		3		V _{dc}	Replaceable CR123 Battery
Average supply current	I _{avg}		35		µA	
Peak supply current	I _{pk}			50	mA	During Xmit
Resolution				12	bits	
Sampling Time				5	Sec	
Battery Life			5		Years	One sample/hr (SF7)

OPERATING SPECIFICATIONS (ACCELEROMETER)

(Unless otherwise specified, all parameters are measured at 24°C @ 3.0V applied)

Parameter	Symbol	Min	Typ	Max	Unit	Notes/Conditions
Dynamic range			±50		g	
Frequency response		1		10k	Hz	±1db
Frequency response		1		15k	Hz	±3db
Resonant frequency	f ₀		30		kHz	
Transverse sensitivity			5		%	
Temperature sensitivity	T _c	-10		5	%	From -20 to 60°C
Non-linearity			±1		%	FSO
Resolution			12		bits	
Residual noise			0.06		g	RMS

OPERATING SPECIFICATIONS (TEMPERATURE SENSOR)⁽¹⁾

(Unless otherwise specified, all parameters are measured at 24°C @ 3.0V applied)

Parameter	Symbol	Min	Typ	Max	Unit	Notes/Conditions
Temp measurement range	T _r	-20		60	°C	
Accuracy			±1.5		°C	
Resolution			12		bits	

⁽¹⁾The temperature sensor is located inside the sensor enclosure. As such, it provides the temperature of the sensor interior, not the ambient temperature around the sensor, nor the temperature of surface to which the sensor is mounted.

8911 WIRELESS ACCELEROMETER FOR PROOF OF CONCEPT

LoRaWAN™ 868/915MHz

ENVIRONMENTAL SPECIFICATIONS

Parameter	Symbol	Min	Typ	Max	Unit	Notes/Conditions
Operating temperature		-20		60	°C	
Storage temperature		-40		120	°C	Without battery
Ambient humidity		0		95	%	Non-condensing
EMI/RFI/ESD protection			IEC61000-4-2, ICE61000-4-6			
Ingress protection	IP			66		
Media compatibility			External exposed surfaces: 316L stainless steel POM polymer EPDM o-ring			
Weight			200		grams	

COMMUNICATION SPECIFICATIONS

Parameter	Symbol	Min	Typ	Max	Unit	Notes/Conditions
Wireless protocol		LoRaWAN™ Class A				
Operating freq (region) ⁽¹⁾			868 (EU) 915 (USA)		MHz	Other frequencies available Contact factory
Transmit power			12	14	dBm	
Receiver sensitivity			-131	-137	dBm	
Activation		OTAA				
Activation keys		Factory defined				Custom keys available Contact factory

⁽¹⁾Each operating frequency is part number specific

BLOCK DIAGRAM

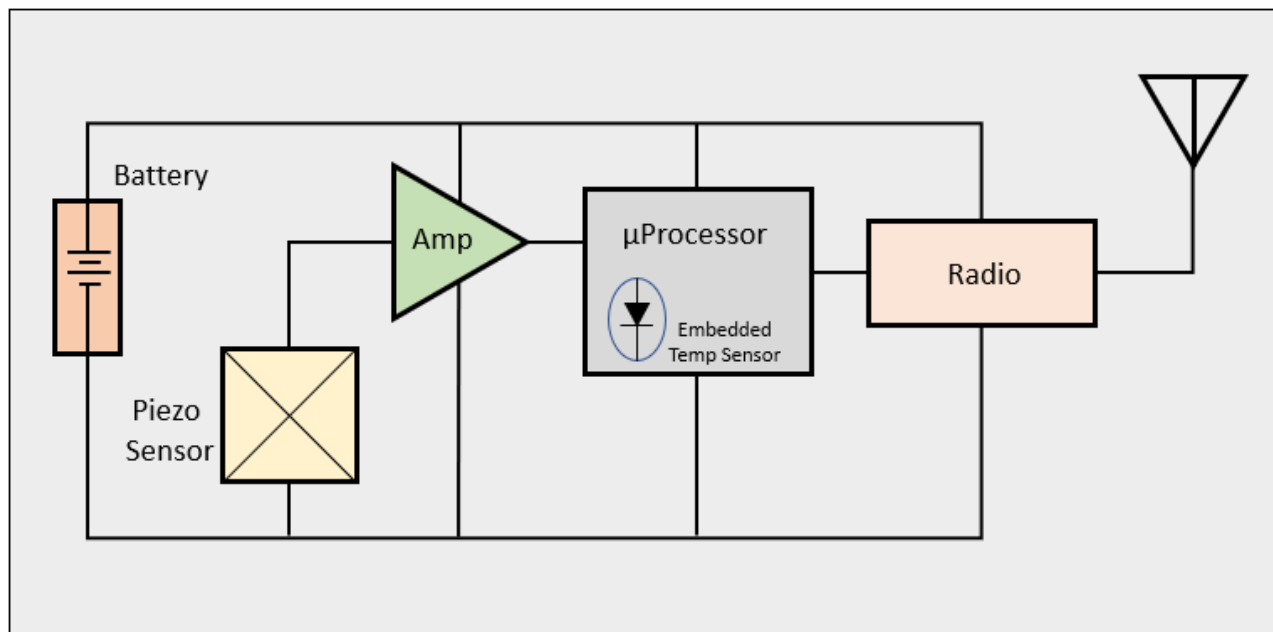

TYPICAL ACCELEROMETER FREQUENCY RESPONSE CURVE

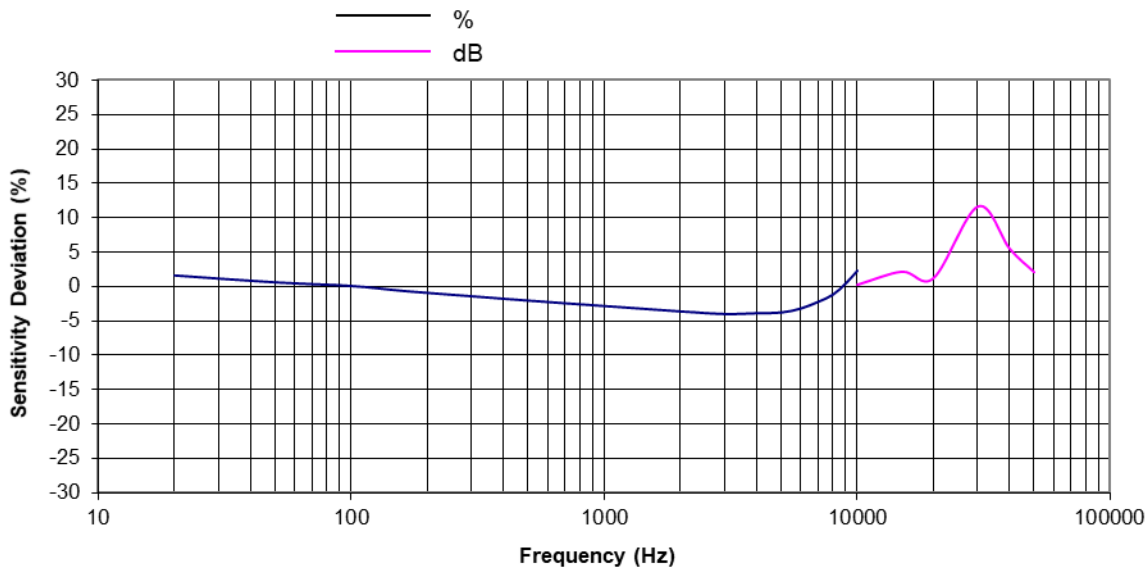

TYPICAL TEMPERATURE RESPONSE CURVE

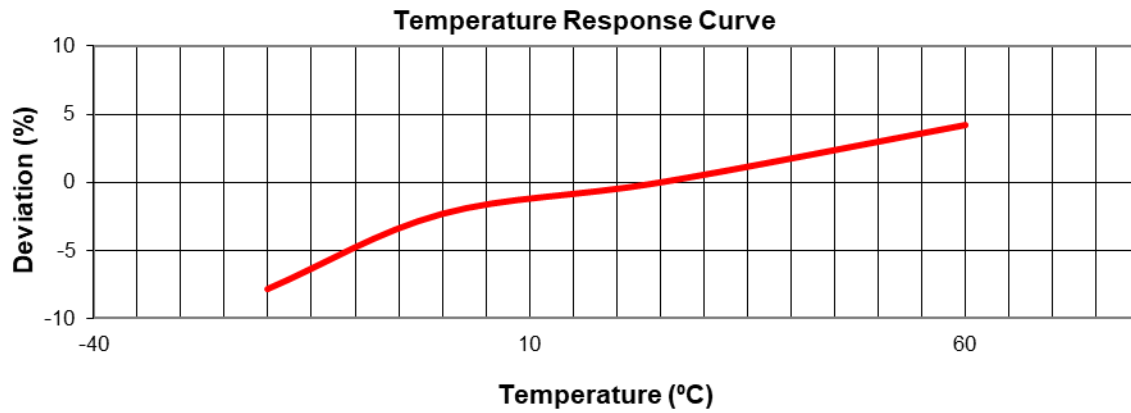

8911 WIRELESS ACCELEROMETER FOR PROOF OF CONCEPT

LoRaWAN™ 868/915MHz

DIMENSIONS

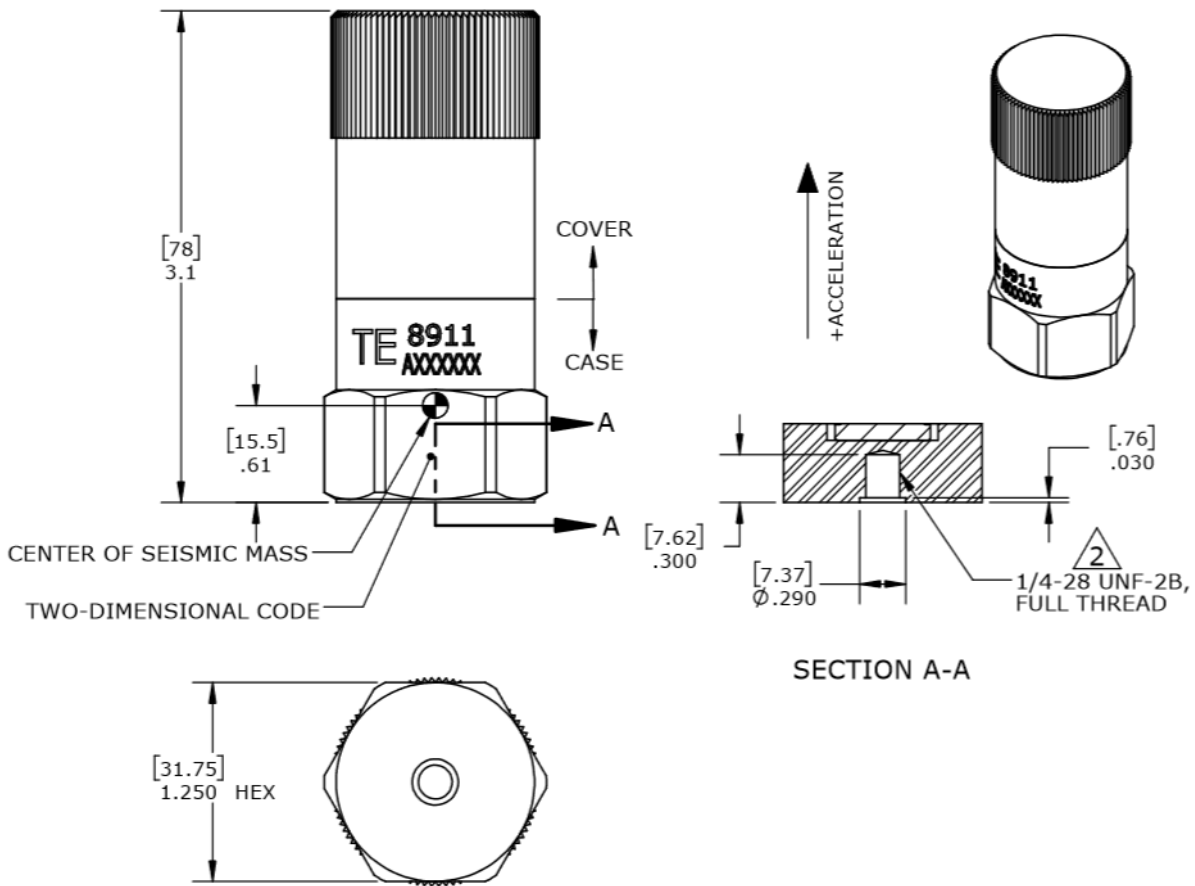

8911 WIRELESS ACCELEROMETER FOR PROOF OF CONCEPT

LoRaWAN™ 868/915MHz

MOUNTING CONSIDERATIONS AND ACCESSORIES

A solid mounting method is required to get optimum performance from the accelerometer. Any loose parts or unsecured mounting features will introduce noise and corrupt the signals of interest. Shown below are six different mounting options available for the 8911 accelerometer for proof of concept.

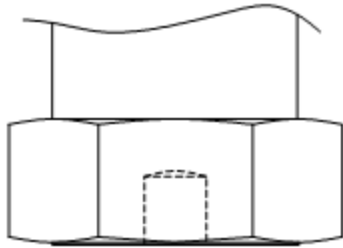

1/4-28 UNF Female THD
(Integrated part of the sensor)

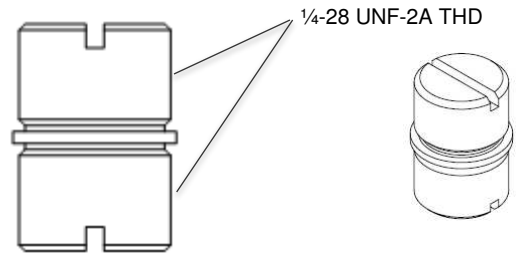

1/4-28:1/4-28 Male Stud
P/N AC-D03636

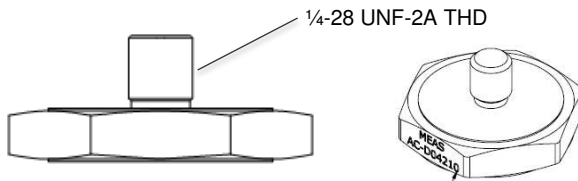

Adhesive Mounting Stud
P/N AC-D04210

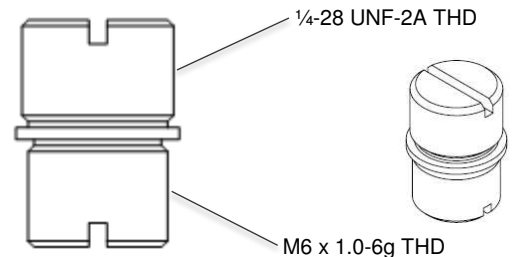

1/4-28:M6 Male Stud
P/N AC-D03665

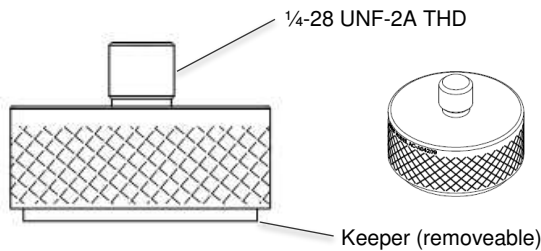

Magnetic Mounting Stud
P/N AC-A04209

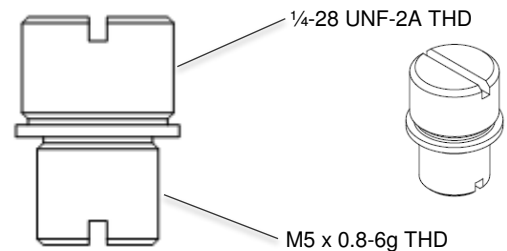

1/4-28:M5 Male Stud
P/N AC-D03664

For the adhesive mounting stud, secure with a rigid adhesive such as epoxy or cyanoacrylate. Do not use pressure sensitive adhesives or foam tapes. For the magnetic mounting stud, remove the keeper prior to attachment. The magnetic mounting will have a 30 lb pull strength when attached to a ferrous surface.

8911 WIRELESS ACCELEROMETER FOR PROOF OF CONCEPT

LoRaWAN™ 868/915MHz

LoRaWAN™ Uplink Payload

0	1	2	3	4	5	6	7	8	9	10	11	12	13
Battery	n Peaks Detected	Temperature (LSB First)	Total Energy (LSB First)	Integration Size (LSB First)	Integration Size (LSB First)	Integration Size (LSB First)	Integration Size (LSB First)	Peak 1 Frequency (LSB first)	Peak 1 Frequency (LSB first)	Peak 1 Magnitude (LSB first)	Peak 1 Magnitude (LSB first)	Peak 1 Ratio	Peak 2 ...

- Frequency, Magnitude, Ratio pattern will repeat n times, once for each peak.
- Total Energy is the total energy (integrated over the whole FFT)
- Integration Size is the size of the integration around the peak. For each peak detected, the embedded algorithm will integrate over a range around the peak to measure the relative energy around this peak, and will also have the effect to disable detection of new peaks around this detected peak
- Frequency is the center frequency of the peak detected
- Magnitude is the magnitude value of the peak detected
- Ratio is the locally integrated (over 'Integration Size' Hz) around this peak compared to the total energy

Data conversion:

Parameter	Range	Resolution	Offset	Hex Data Range	Error code
Battery (%)	0 - 100	1% / bit	0%	0x00 to 0x64	0xFF
Temperature (°C)	-20 to 60°C	0.1°C / bit	-100°C	0x0050 to 0x00A0	0xFFFF
Total Energy (g)	0 - 40	0.001g / bit	0g	0x0000 to 0x9C40	N/A
Integration Size (Hz)	0 - 18000	1Hz / bit	0Hz	0x0000 to 0x4650	N/A
Frequency (Hz)	0 - 18000	1Hz / bit	0Hz	0x0000 to 0x4650	N/A
Magnitude (g)	0 - 40	0.001g / bit	0g	0x0000 to 0x9C40	N/A
Ratio (%)	0 - 100	1% / bit	0%	0x00 to 0x64	N/A

- Custom payload configurations available upon request.

The number of peaks detected by the algorithm is currently fixed at 8. This leads to a minimum LoRaWAN™ payload size of 48bytes, preventing the SF12 to be used in the US 915 configuration. Consequently, even if the network requests the device to use SF12, the device will use SF11 as the payload would not fit in the SF12 frame.

LoRaWAN™ Configuration Downlink Payload

The device sampling period can be adjusted by sending a downlink LoRaWAN™ frame in the following format:

0	1	2	3	4
0x02	Sampling period in minutes (MSB first)			

Minimum sampling period is 1-minute, maximum period is 1440 seconds (24 hours)

Example of a measurement interval set to 20min: 0200000014

DOWNLINK

Scheduling

replace first last

FPort

11 Confirmed

Payload

bytes fields 02 00 00 00 14

8911 WIRELESS ACCELEROMETER FOR PROOF OF CONCEPT

LoRaWAN™ 868/915MHz

WORKFLOW

When the sensor powers up it performs a self-diagnostic then tries to join the LoRaWAN™ network using OTAA. The sensor tries to join the network every 10 second and increases the join timer at every failed attempt by 20%, up to 1 hour maximum. After a successful join the sensor enters sampling mode.

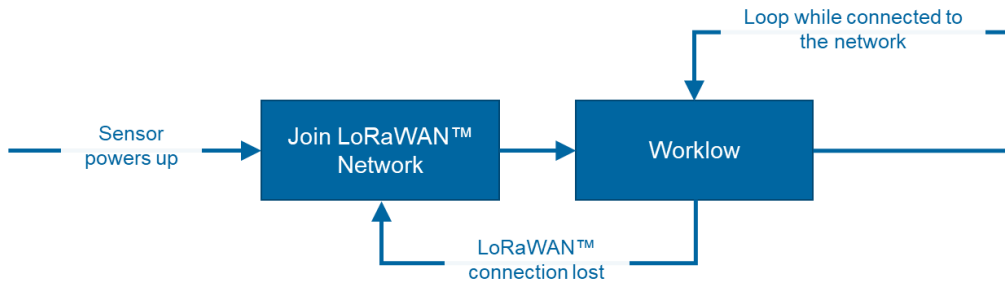

Once a LoRaWAN™ network has been joined, the sensor will loop through this workflow with a user defined period. If the LoRaWAN™ transmission fails too many times the sensor will consider it has left the LoRaWAN™ network and will go back to joining a network.

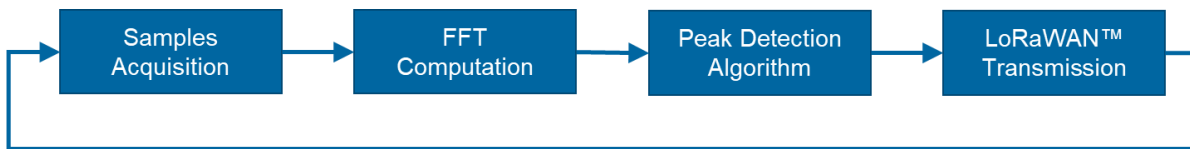

- Pressing the push button on the sensor at any point during the sensor's life cycle will automatically trigger a new capture and data analysis.

BATTERY LIFE

The Sensor battery life will greatly depend on LoRa® spread factor (SF), therefore on sensor proximity from a gateway and network quality.

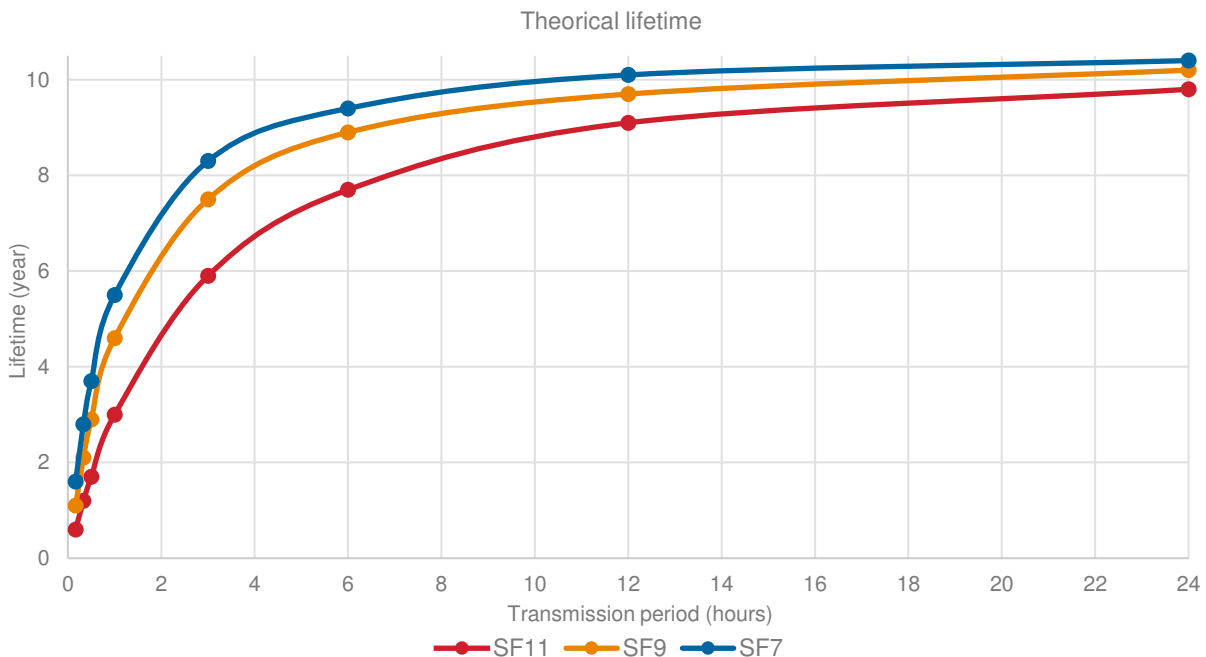

8911 WIRELESS ACCELEROMETER FOR PROOF OF CONCEPT

LoRaWAN™ 868/915MHz

USING AND DISPLAYING DATA FROM THE SENSOR

The sensor vibration data in its FFT format can be used to construct visual displays and tables that provide significant information regarding the operation and health of the machinery to which it's attached. Examples are shown below:

Raw Data:

RAW:	6408E4042D0A07010808A80017420B2E000A860219000508001700031A101400056A170F0002DD0E0C0004B1060A0002
Index:	0/300
Timestamp:	2019-12-16T23:15:39.74Z

Basic Data Table:

Peak Frequency (Hz)	Amplitude of Peak	% of Total Spectral Energy
2056	168	23
2882	46	10
694	25	5
8	23	3
4122	20	5
5994	15	2
3805	12	4
1713	10	2
Total Energy		2.605g

FFT Visual Display:

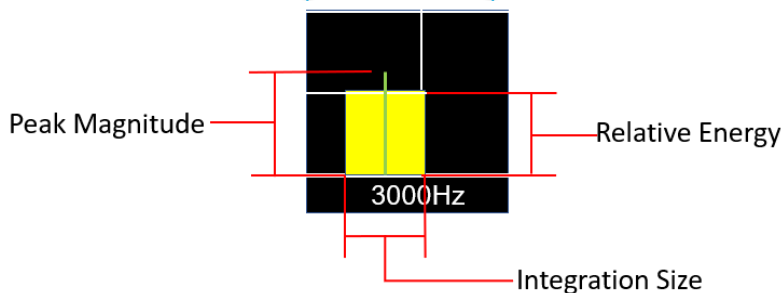
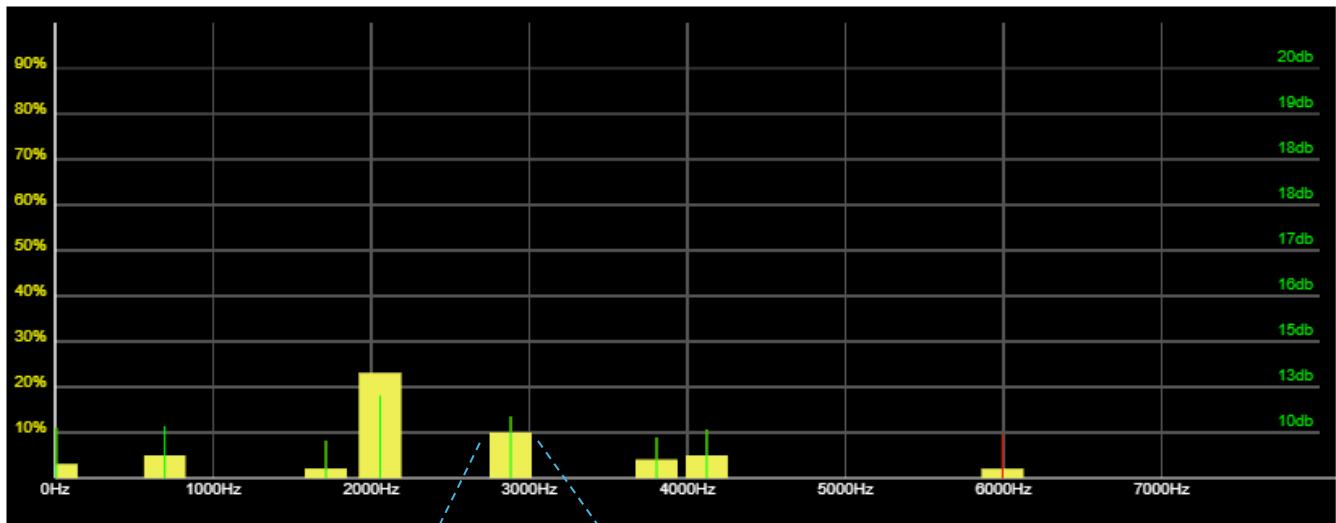

8911 WIRELESS ACCELEROMETER FOR PROOF OF CONCEPT

LoRaWAN™ 868/915MHz

CONTROLS AND INDICATORS

The sensor has a single push button and 2 LEDs that indicate its status, one blue and one red.

- Pressing the push button on the sensor at any point during the sensor's life cycle will automatically trigger a new capture and data analysis. This is useful when setting up the sensor in an application. No waiting for a data capture from the normal cycle.
- Blue LED:
 - will light-up for two seconds when sensor requests to join LoRaWAN™ network, and receives join acceptance
 - will light-up shortly when sensor samples data, transmits LoRaWAN™ payload, receives acknowledgement
- Red LED:
 - will light-up for two seconds if the LoRaWAN™ network join request is not accepted
 - will light-up short shortly if a transmitted LoRaWAN™ payload is not acknowledged
- Illumination of the colored LEDs can be seen through the translucent cover when it's attached.
- To gain access to the push-button and indicator LEDs, simply unscrew the top portion of the sensor housing and locate these components on the PC board. See image below.

