

SI & SA series – high-precision inertial sensors

The capacitive inclinometers and accelerometers are based on single crystal silicon sensor elements and utilize state-of-the-art micromachining technology to achieve large signal-to-noise ratios and excellent stability over temperature. Due to high aspect ratio microstructures (HARMS) the sensors feature ultra-low cross axis sensitivities. The patented AIM (Air gap Insulated Microstructures) technology minimizes parasitic capacitances.

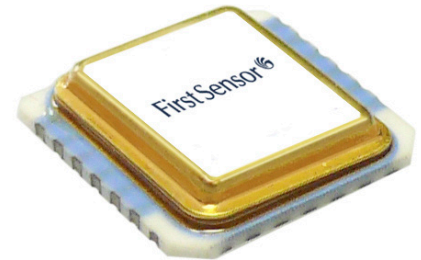

Benefits of the AIM technology

- Ultra-low cross axis sensitivity due to HARMS technology
- Thin-film free mechanical components, single crystal silicon based
- Minimizing of parasitic capacitances due to insulation of the functional components by air gap
- Complete dry processing
- Excellent thermal performance
- Large signal-to-noise ratio
- Mechanical over-damped to reduce parasitic signals
- Customer specific measurement ranges due to flexible adjustment of mass, spring and damping

Features of the sensor system

- Dual axis measurement
- Excellent stability over temperature
- Digital SPI interface
- High resolution ADC offering more than 100 dB dynamic range
- Configurable bandwidth output filter
- Shock survival 1500 g
- Hermetically sealed package
- Customized sensor solutions for packaging and signal processing

Certificates

- Quality Management System according to EN ISO 9001
- Qualified according to DIN EN 60068, DIN EN 60749, MIL-STD-883
- RoHS and REACH compliant

Applications

- Geoengineering
- Condition monitoring
- Navigation
- Security systems
- Platform control and stabilization
- Tilt sensing and leveling
- Industrial applications

SI & SA series – high-precision inertial sensors

Performance characteristics

ASSP

Parameter	Condition	Min.	Typ.	Max.	Unit
Supported nominal capacitance		0.25		15	pF
Differential capacitance range		-750		750	fF
Input noise	at max. gain settings		50		zF/ $\sqrt{\text{Hz}}$
Linearity	at max. voltage output	11			Bit
ADC dynamic range	in 100 Hz BW		100		dB
Output bandwidth		3		420	Hz
Output data rate		6		1563	Hz
ASSP resolution	2's complement		24		Bit
Supply voltage		4.75	5.00	5.25	V
Supply current		20	24	28	mA
Power down current			1		μA
Operating temperature range		-40		85	$^{\circ}\text{C}$
Resolution temperature sensor			14		Bit
Sensitivity temperature sensor			80		LSB/K

Typical performance characteristics ⁽¹⁾

Inclinometer SI-11.S1.C-30

Sensor-ASSP system

Parameter	Condition	SI-11.S1.C-30	Unit
Measurement range	Full scale (linear @ $\pm 30^{\circ}$)	± 30 (± 90)	$^{\circ}$
Resolution	@ 10 Hz	< 0.0015	$^{\circ}$
Scale factor (repeatability)	Short-term	± 35	ppm
Scale factor (temperature coefficient)	Without calibration	± 50	ppm/K
Bias (repeatability)	Short-term	± 0.0030	$^{\circ}$
Bias (temperature coefficient)	Without calibration	± 0.0025	$^{\circ}/\text{K}$
Non-linearity	Full scale	< 0.3	%
Noise density		< 0.0004	$^{\circ}/\sqrt{\text{Hz}}$
Digital interface		SPI	
Capacitive sensing element			
Noise density	calculated	< 3.0	aF/ $\sqrt{\text{Hz}}$
Capacitive sensitivity		450...750	fF/g
Frequency response	3dB frequency	150	Hz
Damping ratio		1.5	
Measurement voltage	RMS	< 1.2	V
Shock survival	Bare die	> 2500	g

Specification note

(1) Maximum and minimum ratings of the performance parameters depend on the exact set-up of the sensor settings. Please contact First Sensor for further information.

SI & SA series – high-precision inertial sensors

Typical performance characteristics ⁽¹⁾

Accelerometer SA-12.S1.C-3

Sensor-ASSP system

Parameter	Condition	SA-12.S1.C-3	Unit
Measurement range	Full scale	±3	g
Resolution	@ 10 Hz	< 40	µg
Scale factor (repeatability)	Short-term	±35	ppm
Scale factor (temperature coefficient)	Without calibration	±50	ppm/K
Bias (repeatability)	Short-term	±60	µg
Bias (temperature coefficient)	Without calibration	±130	µg/K
Non-linearity	Full scale	< 0.6	%
Noise density		< 12	µg/√Hz
Digital interface		SPI	

Capacitive sensing element

Noise density	calculated	< 1.0	aF/√Hz
Capacitive sensitivity		175...250	fF/g
Frequency response	3dB frequency	900	Hz
Damping ratio		0.9	
Measurement voltage	RMS	< 1.8	V
Shock survival	Bare die	> 2500	g

Accelerometer SA-13.S1.C-8

Sensor-ASSP system

Parameter	Condition	SA-13.S1.C-8	Unit
Measurement range	Full scale	±8	g
Resolution	@ 10 Hz	< 65	µg
Scale factor (repeatability)	Short-term	±50	ppm
Scale factor (temperature coefficient)	Without calibration	±50	ppm/K
Bias (repeatability)	Short-term	±150	µg
Bias (temperature coefficient)	Without calibration	±420	µg/K
Non-linearity	Full scale	< 0.6	%
Noise density		< 20	µg/√Hz
Digital interface		SPI	

Capacitive sensing element

Noise density	calculated	< 0.3	aF/√Hz
Capacitive sensitivity		50...70	fF/g
Frequency response	3dB frequency	1600	Hz
Damping ratio		0.6	
Measurement voltage	RMS	< 3.0	V
Shock survival	Bare die	> 2500	g

Specification note

(1) Maximum and minimum ratings of the performance parameters depend on the exact set-up of the sensor settings. Please contact First Sensor for further information.

SI & SA series – high-precision inertial sensors

Typical performance characteristics ⁽¹⁾

Accelerometer SA-14.S1.C-15

Sensor-ASSP system

Parameter	Condition	SA-14.S1.C-15	Unit
Measurement range	Full scale	±15	g
Resolution	@ 10 Hz	< 95	µg
Scale factor (repeatability)	Short-term	±50	ppm
Scale factor (temperature coefficient)	Without calibration	±50	ppm/K
Bias (repeatability)	Short-term	±200	µg
Bias (temperature coefficient)	Without calibration	±700	µg/K
Non-linearity	Full scale	< 0.6	%
Noise density		< 30	µg/√Hz
Digital interface		SPI	
Capacitive sensing element			
Noise density	calculated	< 0.25	aF/√Hz
Capacitive sensitivity		30...45	fF/g
Frequency response	3dB frequency	2000	Hz
Damping ratio		0.5	
Measurement voltage	RMS	< 3.7	V
Shock survival	Bare die	> 2500	g

Specification note

(1) Maximum and minimum ratings of the performance parameters depend on the exact set-up of the sensor settings. Please contact First Sensor for further information.

SI & SA series – high-precision inertial sensors

Dimensional drawing

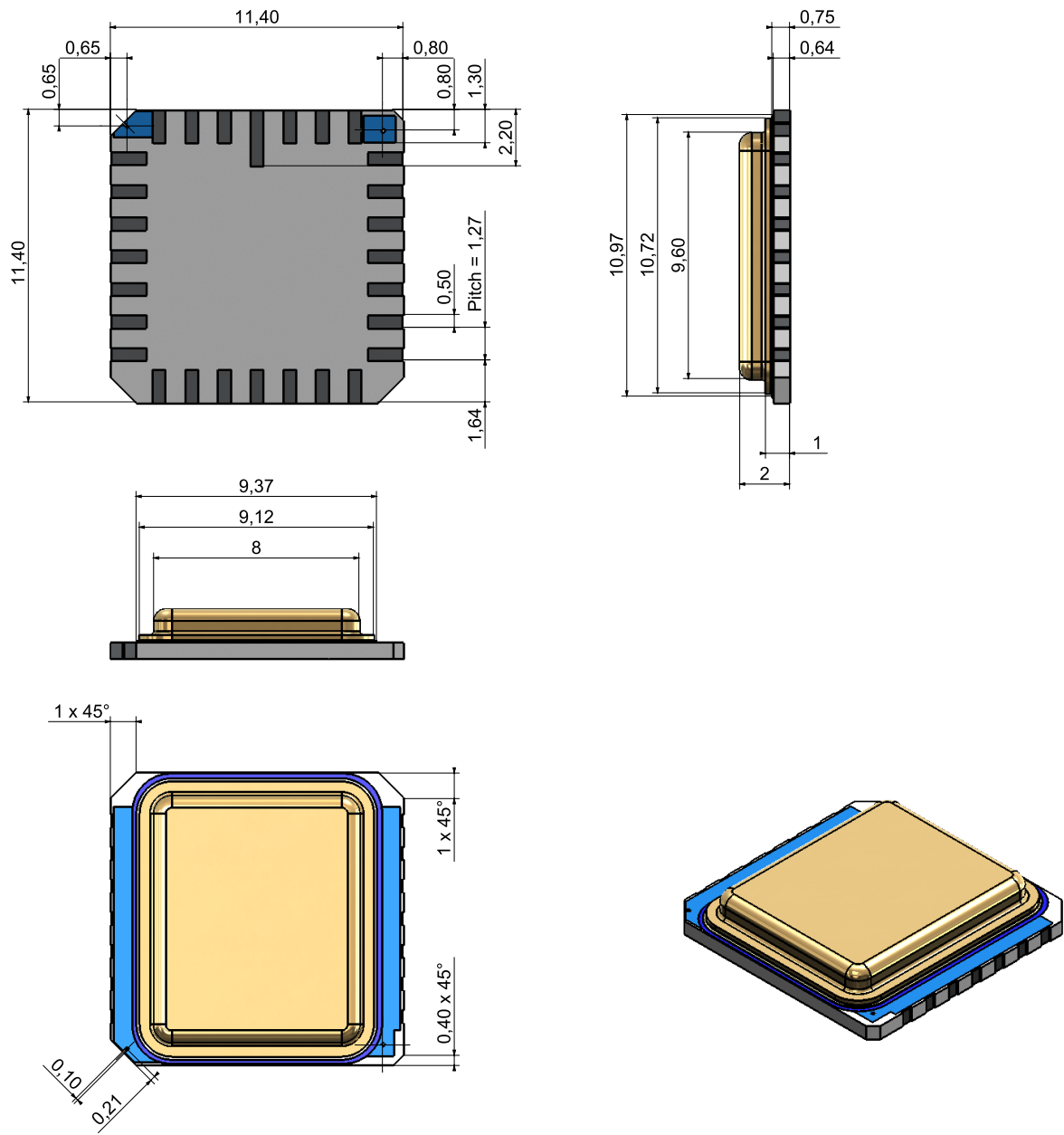

dimensions in mm

SI & SA series – high-precision inertial sensors

Electrical connection

Pin assignment

Pin	Mnemonic	Description	Comment
01...04	NC	Not connected	Should be left as an open pin
05	GND	Ground pin	
06	SSN	Serial select line for SPI	
07	SCK	Serial clock for SPI	
08	MOSI	Master out - slave in for SPI	
09	MISO	Master in - slave out for SPI	
10	DVDD	Digital supply voltage	100 pF bypass capacitor to GND
11	GND	Ground pin	
12...18	NC	Not connected	Should be left as an open pin
19	GRES	Actuation reference	100 μ F polarized capacitor to GND (ESR < 1 Ω and DCL < 6 μ A is recommended)
20	CEN	Chip enable	Connect 10 k Ω Resistor to VDD (achieve the power down mode by applying GND)
21	AVDD1	1st Analog supply voltage	Connect 100 nF and 100 pF bypass capacitors to GND
22	AVDD2	2nd Analog supply voltage	100 pF bypass capacitor to GND
23...28	NC	Not connected	Should be left as an open pin

Pin layout and external circuitry

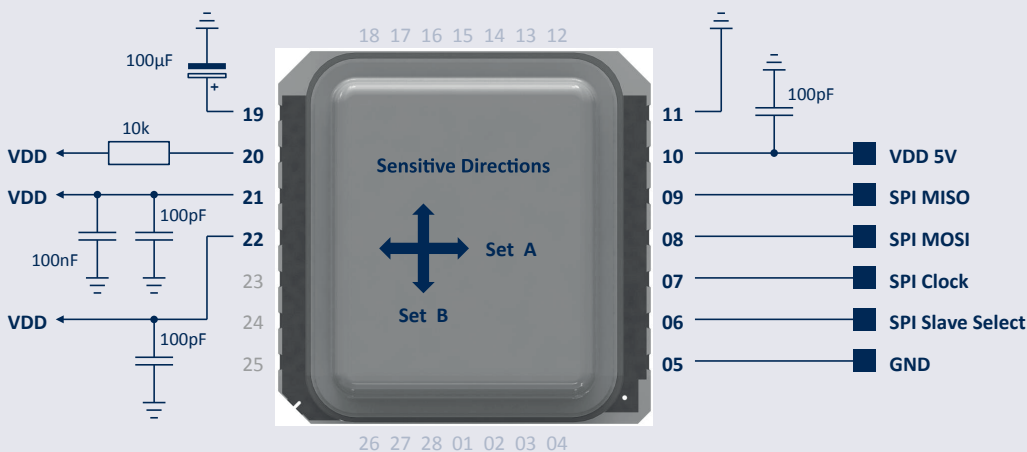

SI & SA series – high-precision inertial sensors

Functional description of the sensor-ASSP system

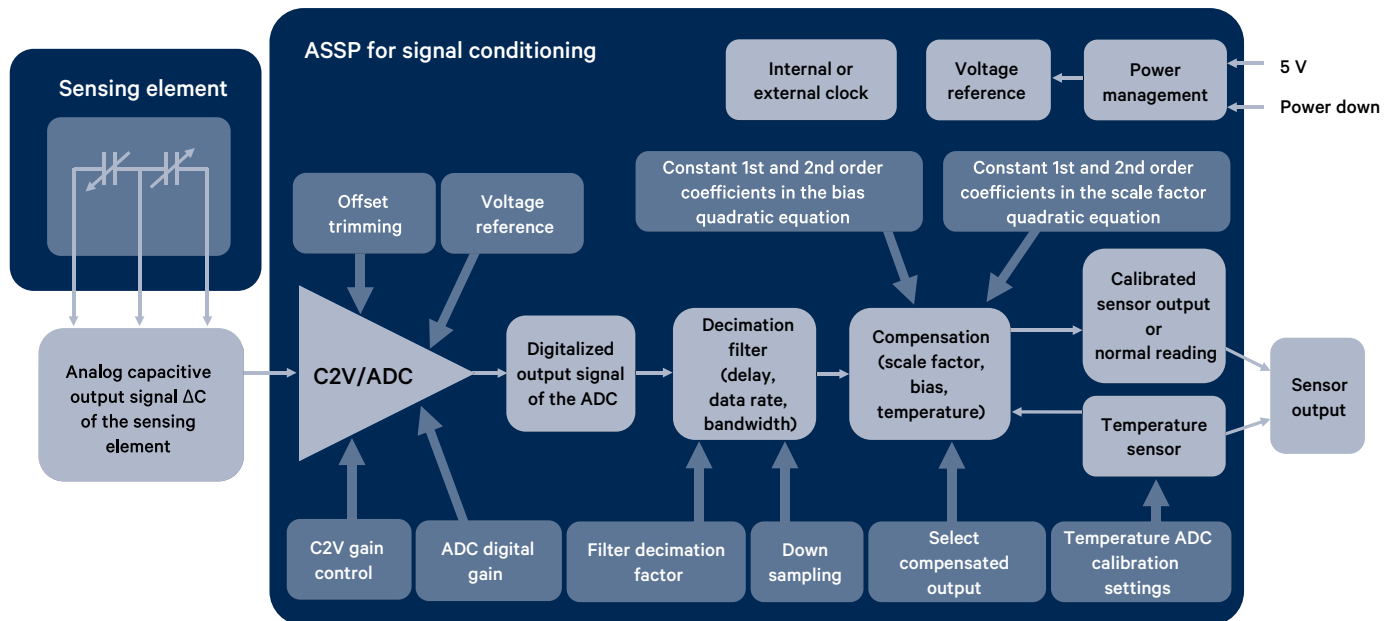

Fig. 1: Block diagram of the sensor system

SPI communication

As it is shown in Figure 2 the ASSP is controlled by the interface register which consists of SPI register and system register. The system controller manages the interface between the registers. The SPI register is an interface that enables the user to read and calibrate the sensor outputs (acceleration and temperature), while the system register and the MTP register store the trimming programmable data of different blocks. The SPI register is accessed through the device SPI interface while the system register is accessed indirectly through the SPI register by using the appropriate SPI command.

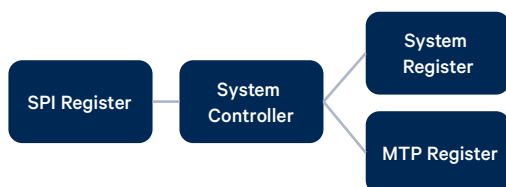
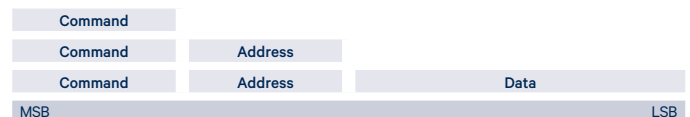

Fig. 2: Block diagram of the register architecture

The chip has a standard 4-wire SPI interface for communication. The SPI frame has 3 forms: it can either be a command

plus address or a command plus address and data. The width of the commands and addresses is 4 bits, while the width of the data can be multiples of 8 bits. The different frame structures are as follows:



The digital interface of the ASSP operates at 5 V logic levels and the reset signal has an internal pull-up resistance. The chip enable must be pulled high for the chip to power up. The SPI interface can be used after 1 ms from enabling the chip (to account for the digital part startup sequence). The electrical and timing characteristics of the SPI interface are detailed in the table below and Figure 3.

The chip operates as the slave in the SPI communication. To initiate the communication the Serial Select Bar (CSB) must be kept low. The change in the data lines Master Input Slave Output (SDO) and Master Output Slave Input (SDI) must be synchronized to the falling edge of the SPI Clock (SCK) (ranging from 200 kHz to 10 MHz), while the master and slave samples their inputs on the rising edge of SCK.

SI & SA series – high-precision inertial sensors

Functional description of the sensor-ASSP system

SPI interface characteristics

Parameter	Symbol	Conditions	Min.	Typ.	Max.	Unit
Low level input voltage	VIL		0		0.1 x DVDD ⁽²⁾	V
High level input voltage	VIH		0.8 x DVDD ⁽²⁾		DVDD ⁽²⁾	V
Low level output voltage	VOL	ioL = 0 mA (capacitive load)		DGND		V
High level output voltage	VOH	ioH = 0 mA (capacitive load)		DVDD ⁽²⁾		V
Pull-up resistor ⁽³⁾	R _{pull_up}	Internal pull-up R to VDD		100		kΩ
Pull-down resistor	R _{pull_down}	Internal pull-down R to VSS		-		kΩ
Input capacitance of SSB pad	Cin _{ssb}				30	pF
Input capacitance of SPI pads (excluding SSB)	Cin				3	pF
Fspi4	SPI clock input frequency	Max. load 25pF on SDO or SDI	0.2	0.4	10	MHz
Tlow_sck_4	SCK low pulse		50			ns
Thigh_sck_4	SCK high pulse		50			ns
Tsetup_sdi_4	SDI setup time		0			ns
Thold_sdi_4	SDI hold time		2			ns
Tdelay_sdo_4	SDO output delay	Load 25pF			45	ns
T_setup_csb_4	Chip select setup time		1			Tsck
T_hold_csb_4	Chip select hold time		1			Tsck

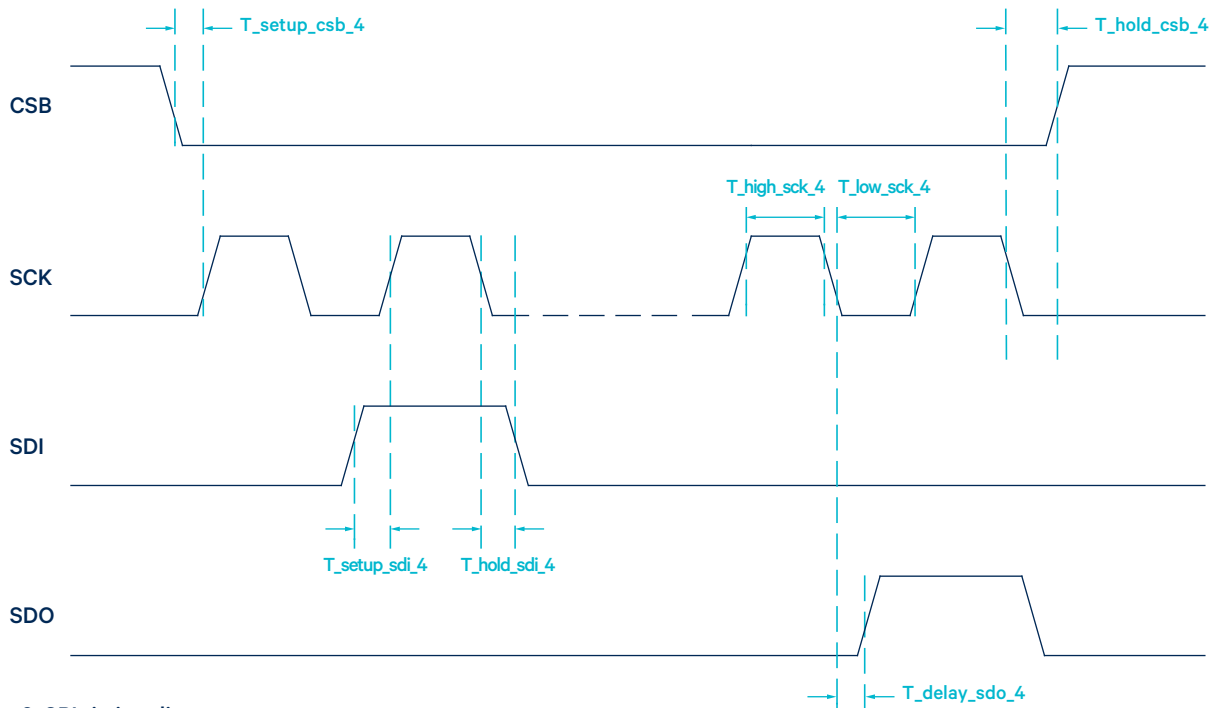

Fig. 3: SPI timing diagram

Specification notes

- (2) Power supply DVDD = 5 V typical.
- (3) Only used for reset input.

SI & SA series – high-precision inertial sensors

Functional description of the sensor-ASSP system

SPI register file

There are 16 SPI registers with addresses starting from address 0x0 to 0xF. Each SPI register is an 8 bit width data (from bit 0 to 7) as shown below.

Address dec	Bits							
	7	6	5	4	3	2	1	0
0	DataRDY							
1	Output accelerometer [23:0]							
2								
3		0	0	0	0	0	0	0
4	0	0	Output temperature [13:0]					
5								
6	Reserved by First Sensor							
7								
8	32 bit data							
9								
10								
11								
12	Address							
13	Command							
14	Reserved by First Sensor							
15								

Registers 0 to 5 contain the output of the temperature sensor as well as the output of the accelerometer including the DataRDY bit. This is used to indicate that a new accelerometer reading data is available and returns to “0” when the data is read. Furthermore, there are different controls inside the SPI register:

- Address 0 to 3: data of the accelerometer
- Address 4 to 5: data of the temperature sensor
- Address 8 to 11: data to read and write in the system register
- Address 12: system register address to read and write
- Address 13: system register command

The SPI frame that is used for the communication through the SPI register is composed of a command and an address following by arguments. The SPI command and address are 4 bit words and the data are composed of n multiples of 8 bit words. The n value is from 1 to 4. In order to read a register, the address must be followed by one or several 0x00 data corresponding to the number of 8 bit registers to be read. The reading address is automatically incremented at each new 0x00 data sent. The available SPI commands are as follows:

Command 4 bits	Address 4 bits	Arguments 8 bits	Description
0x5	SPI register address	n multiples of 0x00	Read n multiples of 8 bits data from the SPI address
0x7		Data	Write n multiples of 8 bits data from the SPI address

SI & SA series – high-precision inertial sensors

Functional description of the sensor-ASSP system

Reading the output of the sensors

The accelerometer's output (24 bit word) needs to be extracted from the 4 read registers (32 bit word). An SPI example frame used to read the accelerometer's output registers is:

```
void read_acc (unsigned char data[])
{
    P3OUT &= ~BIT0;
    SPI_byte_send(0x50 + 0x00);           //Reading Command 0x50 & Start Address SPI 0x00
    data[0] = SPI_byte_read();           //Data SPI register 0x0
    data[1] = SPI_byte_read();           //Data SPI register 0x1
    data[2] = SPI_byte_read();           //Data SPI register 0x2
    data[3] = SPI_byte_read();           //Data SPI register 0x3
    P3OUT |= BIT0;
}
```

The argument is 4 "0x00" data which mean that 4 registers are read beginning from the SPI register address 0x0. Please note that the 24 bit accelerometer's output (first bit is DataRDY following by 24 bits output data) is coded in two's complement. The reading rate should be slightly higher than the output rate of the decimation filter to ensure the proper

acquisition of all samples. DataRDY bit is set to "1" in each new sample and returns automatically to "0" when data is read. Therefore, DataRDY bit should be checked for each acquired sample to guarantee that the acquired sample is a new sample.

The temperature sensor's output (14 bit word) comes directly from the 2 read registers (16 bit word). An example SPI frame used to read the temperature output registers is:

```
void read_temp(unsigned char data[])
{
    P3OUT &= ~BIT0;
    SPI_byte_send(0x50 + 0x04);           //Reading Command 0x50 & Start Address SPI 0x04
    data[0] = SPI_byte_read();           //Data SPI register 0x4
    data[1] = SPI_byte_read();           //Data SPI register 0x5
    P3OUT |= BIT0;
}
```

The argument is 2 "0x00" data which mean that 2 registers are read beginning from the SPI register address 0x4.

SI & SA series – high-precision inertial sensors

Functional description of the sensor-ASSP system

Configuration

Different configurations of the sensor are selectable by writing bits in the system register. This subsection explains the way to configure the sensor. For the purpose of communication to the system register, one can use the dedicated SPI registers slots (from address 0x8 to 0xD). The following table describes the 8 bits commands used to access the system register via the address 0xD of the SPI register.

Command 8 bits	Description
0x01	Read from system register
0x02	Write to system register

The system register reading command is composed of two steps. The first one reads and copies the 32 bit data from the address of the system register to the addresses 0x8, 0x9, 0xA and 0xB slots of the SPI register. The second step is similar to the read out of the accelerometer or temperature data. However, the read out refers to the addresses 0x8, 0x9, 0xA and 0xB of the SPI register. The system register reading and writing command is described in the following table.

Mnemonic	Command	SPI register address	Arguments			Description
			Data	System register address	System register command	
RSYS	0x7	0xC		0xAddress	0x01	Read and copy the 32 bit data from the system register to the SPI register
	0x5	0x8	0x00000000			Read the copied data in the SPI register
WSYS	0x7	0x8	32 bit data to write	0xAddress	0x02	Write the desired 32 bit data in the SPI register and copy the data to the indicated address of the system register

SI & SA series – high-precision inertial sensors

Functional description of the sensor-ASSP system

An example SPI frame used to read parameters from the system register is:

```
void read_sys(unsigned char reg_address)
//Step 1 writes the desired system register address to the SPI register 0xC and writes the
//system register command 0x01 to read the data from the system register and to copy the
//data to the SPI register.
{
    P3OUT &= ~BIT0;
    SPI_byte_send(0x70 + 0x0C);           //Writing Command 0x70 and SPI register address
    SPI_byte_send(reg_address);          //System register address
    SPI_byte_send(0x01);                 //Send read System Register Command
    P3OUT |= BIT0;
}
void read_reg(unsigned char dataR[])
//Step 2 is similar to the read out of the sensor output data of the accelerometer and the
//temperature sensor. However, the starting address of the SPI register is 0x8.
{
    P3OUT &= ~BIT0;
    SPI_byte_send(0x50 + 0x08);          //Reading Command 0x50 & Start Address SPI 0x08
    dataR[0] = SPI_byte_read();          //Data SPI register 0x8
    dataR[1] = SPI_byte_read();          //Data SPI register 0x9
    dataR[2] = SPI_byte_read();          //Data SPI register 0xA
    dataR[3] = SPI_byte_read();          //Data SPI register 0xB
    P3OUT |= BIT0;
}
```

An example SPI frame used to write parameters to the system register is:

```
void write_sys(unsigned long parameter, unsigned char system_address)
//As described in Table 8 the command to write data to the system register consists of sending
//the SPI command 0x7 to write the desired data to the SPI register with the starting address
//0x8. Afterwards the system register address is written to the SPI register 0xC and finally
//the data are written to the system register using the system register command 0x02.
{
    P3OUT &= ~BIT0;
    SPI_byte_send(0x70 + 0x08);          //Writing Command & Start Address SPI
    SPI_byte_send(parameter >> 24);     //Send desired data
    SPI_byte_send(parameter >> 16);     //Send desired data
    SPI_byte_send(parameter >> 8);      //Send desired Data
    SPI_byte_send(parameter);           //Send desired Data
    SPI_byte_send(system_address);      //Send System Register Address
    SPI_byte_send(0x02);                 //Send write System Register Command
    P3OUT |= BIT0;
}
```

SI & SA series – high-precision inertial sensors

Description of system registers

System register map

The system register map consists of 52 registers. The system register address is 8 bit coded. Each system register slot is a 32 bits width data (from bit 0 to 31). The main registers to configure the sensor systems are as follows:

Address	Bits																															
dec	31	30	29	28	27	26	25	24	23	22	21	20	19	18	17	16	15	14	13	12	11	10	9	8	7	6	5	4	3	2	1	0
0																																
1																																
2		LVM			COMP SEL				OUT BW																							
...																																
5					CLK																											
6																																
7									OUT LIMIT																							
8																																
9													SET SEL																			
...																																
13																																
14																																
15																																
16																																
...																																
24									A OFFSET N																							
25																																
26																																
27																																
28									A GAIN 2																							
...																																
32																																
...																																
35																																
36																																
37																																
...																																
40																																
41																																
42																																
43																																
44																																
45																																
46																																
47																																
48																																
49																																
50																																
51																																

SI & SA series – high-precision inertial sensors

Description of system registers

Capacitance-to-voltage and sense control settings

The signal conditioning of the analog, capacitive output of the micromechanical transducer is done using the capacitance-to-voltage converter (C2V). The C2V has several programmable options to select the sensor output channel, to control the gain settings or to overcome any offset in the input signal. This also enables the C2V to cancel out the rest capacitance of the accelerometer. The C2V consists of two main stages. Separate settings for sense modes in C2V are used depending on the sense signals. Furthermore, the gain of the ADC is a signed digital gain that is used to adjust the overall scale factor of the sensor. The following table shows the C2V and ADC registers, their address, read/write permissions and ASSP default values.

Register name	Register address				Access R/W	Default Dec	Description
	Dec	Bits	MSB	LSB			
SET_SEL	9	2	19	18	R/W	2	Sensor output control "1": 1st sense channel SetA "2": 2nd sense channel SetB
LVREF	40	4	9	6	R/W	0	"0" is 2.1 V in coarse trimming steps of 145 mV up to 4.4 V
LVM	2	1	30	30	R/W	1 (SI) 0 (SA)	Voltage Mode "0": Normal (2.1 V...4.4 V) selected by LVREF "1": 1.2 V excitation voltage (SI)
SNS_A_GAIN_1	28	4	25	22	R/W	11 (SI) 12 (SA)	Gain control 1 for channel SetA C2V
SNS_A_GAIN_2	28	3	28	26	R/W	5 (SI) 2 (SA)	Gain control 2 for channel SetA C2V
SNS_A_GAIN_3	32	4	27	24	R/W	15	Gain control 3 for channel SetA C2V, "4" if GAIN1=0, "8" if GAIN1=1, "15" if any other value of GAIN1
SNS_A_OFFSET_P	42	13	31	19	R/W	5667	Positive offset trimming for channel SetA C2V signal
SNS_A_OFFSET_N	24	13	31	19	R/W	5667	Negative offset trimming for channel SetA C2V signal
SNS_A_ADCGAIN	36	20	19	0	R/W	500	ADC digital gain (signed) of the sense channel SetA
SNS_B_GAIN_1	37	4	30	27	R/W	11 (SI) 12 (SA)	Gain control 1 for channel SetB C2V
SNS_B_GAIN_2	44	3	4	2	R/W	5 (SI) 2 (SA)	Gain control 2 for channel SetB C2V
SNS_B_GAIN_3	13	4	7	4	R/W	15	Gain control 3 for channel SetB C2V, "4" if GAIN1=0, "8" if GAIN1=1, "15" if any other value of GAIN1
SNS_B_OFFSET_P	14	13	12	0	R/W	5667	Positive offset trimming for channel SetB C2V signal
SNS_B_OFFSET_N	15	13	12	0	R/W	5667	Negative offset trimming for channel SetB C2V signal
SNS_B_ADCGAIN	26	20	31	12	R/W	500	ADC digital gain (signed) of the sense channel SetB

SI & SA series – high-precision inertial sensors

Description of system registers

SET SEL

The register SET SEL is used to select the sensitive direction of the sensor. Up to now, simultaneous read out of both sensor channels is not possible. However, you can switch between the two channels using the command. If SNS SEL=1 sense channel SetA is measured, SET SEL=2 means sense channel SetB, that is placed orthogonal compared to axis SetA, is measured. When the output channel has been changed, the following register settings shall be used to decrease the effect of input parasitic according to SetA or SetB as follows:

Channel SetA (SNS SEL=1)	Channel SetB (SNS SEL=2)
OCS1, Register 15, Bit 31-24, 54 (dec)	OCS1, Register 15, Bit 31-24, 182 (dec)
OCS2, Register 15, Bit 23-16, 182 (dec)	OCS2, Register 15, Bit 23-16, 54 (dec)
OCS3, Register 16, Bit 15-8, 182 (dec)	OCS3, Register 16, Bit 15-8, 54 (dec)
OCS4, Register 16, Bit 7-0, 54 (dec)	OCS4, Register 16, Bit 7-0, 182 (dec)

LVREF

The voltage reference provides the low voltage required for driving the sensors excitation. The voltage can output 2.1 V and up to 4.4 V. The reference output can be trimmed using register LVREF, LVREF=0 (default) is corresponding to 2.1 V and LVREF=15 is corresponding to 4.4 V.

LVM

It is recommended to use a low voltage mode for excitation reference voltage when working with the SI sensor. Using the low voltage mode leads to a measurement voltage of 1.2 V. The normal register LVREF is not active when using the low voltage mode.

SNS GAIN 1 and SNS GAIN 2

The total C2V gain is given by the following equation (1), where LVREF is the excitation voltage reference that can be between 2.1 V and 4.4 V. The minimum C2V gain is 0.365 V/pF and the maximum gain is 97.8 V/pF.

$$GAIN_{C2V} = \frac{25 \cdot LVREF \cdot (1 + SNS\ GAIN2)}{9 \cdot (1 + SNS\ GAIN1)} \quad (1)$$

SNS GAIN 3

The C2V bandwidth is determined by SNS GAIN 3, the register value should be 4 if SNS GAIN 1=0, 8 if SNS GAIN 1=1 and 15 for any other value of SNS GAIN 1.

SNS OFFSET P and SNS OFFSET N

Programmability is added at each of the differential input terminals of the C2V for offset cancellation. The controls OFFSET P and OFFSET N are used to control each of these arrays. Changing each control separately will vary the offset capacitor according to the following equation (2):

$$CAP_{Offset, P\&N} = 1500 + 1.5 \cdot OFFSET_{P\&N} \quad (2)$$

The two controls (“P” and “N”) can be used to add a common-mode capacitor which is used to cancel the rest-capacitance of the accelerometer. The maximum value of each register is 8191 which corresponds to 13.78 pF. A portion of this value is taken for cancelling the MEMS rest capacitance and the remaining part represents the dynamic range for trimming the static differential offset.

SI & SA series – high-precision inertial sensors

Description of system registers

ADC GAIN

The sense ADC gain is a signed digital gain used to adjust the overall scale factor of the sensor system. The default value of the ADC gain register is 500. The ADC gain is used to adjust differences of the capacitive scale factor of both channels and different sensor systems while the noise performance is not affected.

Please note, that it is necessary to adjust the C2V and the sense control registers values to use the ADC within an optimized operating range. Regarding the signal flow, which is shown in Figure 4, the analog, capacitive output signal of the sensing element is adjusted by using the offset trimming, the digital ADC gain as well as the C2V gain that is controlled by the parameter SNS GAIN 1, 2, 3 and the voltage reference value.

An optimized, digital output signal of the ADC is obtained when the capacitive sensitivity of the corresponding sensing element matches the supported differential capacitance range of the ASIC (see *Performance characteristics*). Please don't hesitate to contact us if you need further assistance or information to implement the correct settings regarding your application. For example, a step by step suggestion is described in the following.

Suggested procedure to achieve optimized sensor settings

At first, verify the capacitive scale factor and the bias of the sensor by performing a two-point measurement as it is described in chapter *First measurements* of the *SI & SA evaluation kits* data sheet. Following sensor settings should be used, SNS GAIN1=15, SNS GAIN2=0, SNS GAIN3=15, LVREF=0, SNS ADC GAIN=500, SNS OFFSET P=5667 and SNS OFFSET N=5667. Using the digital output data the capacitive output of the micromechanical transducer is approximately calculated by following equation (3):

$$\Delta C \text{ [fF]} = \frac{\text{Out}_{\text{raw}}}{\text{GAIN}_{\text{C2V}} \cdot \text{GAIN}_{\text{ADC}} \cdot 7.5} \quad (3)$$

Afterwards the determined capacitive output is compared to the full scale output that is needed in your application. For example, the application requires a measurement range of $\pm 30^\circ$ that is equal to $\pm 0.5 \text{ g}$ and the determined scale factor is 600 fF/g , your full scale output is $\pm 300 \text{ fF}$ while the total differential capacitance range of the ASSP is $\pm 750 \text{ fF}$ (see chapter *Performance overview of the ASSP*). Therefore, the C2V-Gain-Control should be adjusted to a value of about 2.5 (ratio of 750 to 300).

Also the offset trimming is done by using the results of the two-point measurement. Similar to the calculation of the capacitive scale factor the capacitive value of the bias is obtained by using equation (3). Afterwards the differential input terminals (register SNS OFFSET P and N) of the C2V are used for offset cancellation of both channels as it is described above.

Last step of the suggested procedure is the adjustment of the overall, digital scale factor of the sensor system to achieve comparable scale factors of different sensors and both sensor channels. As shown in chapter *Reading the output of the Sensors* the accelerometer provides a digital output range of 24 bit (first bit is DataRDY followed by 24 bit data). Because the output is coded in two's complement the full scale range is ± 23 bit. Proceeding with the example above (C2V of 2.5, determined scale factor of 600 fF/g , required measurement range of $\pm 30^\circ$, offset trimming has been done) the digital output is adjusted by using the ADC digital gain and the corresponding SNS ADC GAIN register values of both channels.

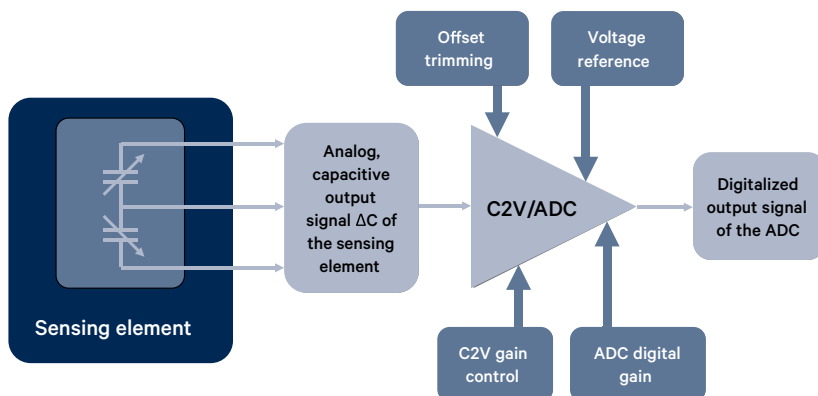

Fig. 4: Signal conditioning of the capacitive output using the control registers of the C2V/ADC

SI & SA series – high-precision inertial sensors

Description of system registers

Filter and output data rate registers

As it is shown in Figure 5, the sensor system offers the output signal in different bandwidths and data rates. The table below illustrates the programmable controls of the decimation filter.

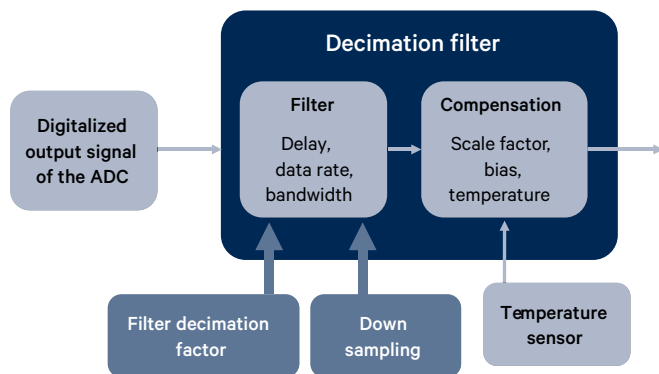

Fig. 5: Programmability of bandwidth and output data rate using the decimation filter

Register name	Register address				Access R/W	Default Dec	Description
	Dec	Bits	MSB	LSB			
OUT_BW	2	3	25	23	R/W	3	Filter decimation factor
DOWN_SAMP_EN	43	1	23	23	R/W	0	Ratio of output data rate and bandwidth "0": Rate factor R=1 "1": Rate factor R=2"
CLK_CONTROL	5	7	31	25	R/W	100	Configures the sampling frequency 200...500 kHz
DOS	43	2	22	21	R/W	0	Output of decimation filter "0": Droop correction output "1": HBF output "2": CIC output"
OUT_LIMIT	7	12	31	20	R/W	4095	Decimation output limiter, set to max if no limit is required
DECI_RESET	36	1	26	26	R/W	1	Global reset of the decimation filter

SI & SA series – high-precision inertial sensors

Description of system registers

OUT BW

OUT BW is the filter decimation factor. The value of OUT BW determines the output data rate.

DOWN SAMP EN

The Value of register determines the relation between the output bandwidth and the output data rate. DOWN SAMP EN=0 is corresponding to R=1 and DOWN SAMP EN=1 is corresponding to R=2. When DOWN SAMP EN=0 is used the output data rate of the sensor is 4 times higher as the bandwidth. DOWN SAMP EN=1 leads to doubled output data rate corresponding to the bandwidth.

CLK CONTROL

The value of sampling frequency f_s is adjustable by using the register CLK_CONTROL.

DOS

The decimation filter is composed of 3 stages. The Cascaded-Integrator-Comb filter (CIC) followed by a Half Band Filter (HBF) and

finally a Droop correction filter (DCF) is used to compensate the non-flat frequency response of the CIC filter. HBF and DCF can be bypassed. The option to control the bypassing is given by register DOS.

OUT LIMIT

Decimation output limiter is used to control the maximum value of the digital output signal. No limiting (set to register OUT_LIMIT to max) leads to 24 bit output data.

DECI RESET

To change the filter decimation factor during operation, resetting the decimation filter (write DECI_RESET = 1 then DECI_RESET = 0) is required after changing the filter decimation factor.

The output data rate is related to the sampling frequency ($f_s = 400$ kHz) by following the equation (4):

$$OUT_{\text{Datarate}} = \frac{f_s}{256 \cdot 2^{\text{OUT_BW}} \cdot R} \quad (4)$$

On chip temperature compensation registers

The temperature compensation block is concerned with compensating the changes in the sensor bias and scale factor with respect to temperature. As a result, the output of the temperature compensation block will be the corrected reading of the accelerometer given by the following equation:

$$ACC_{\text{compensated}} = \frac{(ACC - BIAS)}{SF} \quad (5)$$

The bias with respect to temperature and scale factor with respect to temperature can be obtained using the following equations (6) and (7):

$$BIAS = BIAS_0 + BIAS_1 \cdot (TEMP - T_0) + BIAS_2 \cdot (TEMP - T_0)^2 \quad (6)$$

$$SF = SF_0 + SF_1 \cdot (TEMP - T_0) + SF_2 \cdot (TEMP - T_0)^2 \quad (7)$$

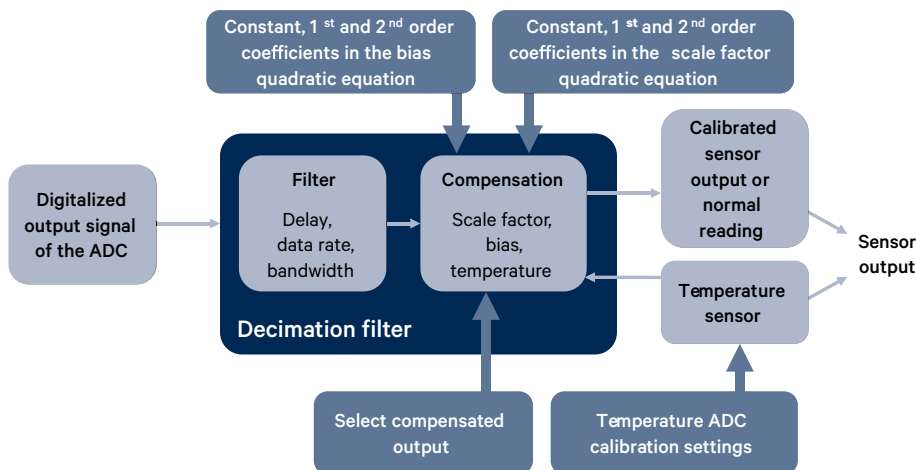

Fig. 6: On chip temperature compensation control settings

SI & SA series – high-precision inertial sensors

Description of system registers

The temperature coefficients for the compensation algorithm of bias and scale factor are shown in the table below. However, the temperature compensation is not mandatory for reliable sensor operation. With COMPSEL=1 the algorithm is bypassed.

Register name	Register address				Access	Default	Description
	Dec	Bits	MSB	LSB	R/W	Dec	
COMP_SEL	2	1	27	27	R/W	0	"1": Normal reading "0": Calibrated reading"
TC_BIAS0	48	30	29	0	R/W	0	Constant in bias quadratic equation
TC_SF0	50	30	29	0	R/W	2 ²⁷	Constant in scale factor quadratic equation
TC_SF2	46	16	31	16	R/W	0	2nd order coeff. in the scale factor quadratic equation
TC_SF1	49	30	29	0	R/W	2500000	1st order coeff. in the scale factor quadratic equation
TC_BIAS2	46	16	15	0	R/W	0	2nd order coeff. in the bias quadratic equation
TC_BIAS1	47	30	29	0	R/W	0	1st order coeff. in the bias quadratic equation
TC_TEMP	51	20	19	0	R/W	500000	Uncalibrated temperature ADC output at nominal temperature

The parameters should be computed offline and then stored in their corresponding registers. The obtained coefficients are scaled and converted into hexadecimal values (2's complement notation) to be written in the corresponding as shown in the following table:

Parameter	Register name	Default	Calculated values	Format
		Dec	Dec	
SF ₂	TC SF2	0	SF ₂ · 2 ⁵⁵	signed 2's complement
BIAS ₂	TC BIAS2	0	BIAS ₂ · 2 ²⁸	signed 2's complement
BIAS ₁	TC BIAS1	0	BIAS ₁ · 2 ²⁰	signed 2's complement
BIAS ₀	TC BIAS0	0	BIAS ₀	unsigned
SF ₁	TC SF1	2500000	SF ₁ · 2 ⁴⁶	signed 2's complement
SF ₀	TC SF0	2 ²⁷	SF ₀ · 2 ²⁷	unsigned
T ₀	TC TEMP	500000	T ₀	unsigned